

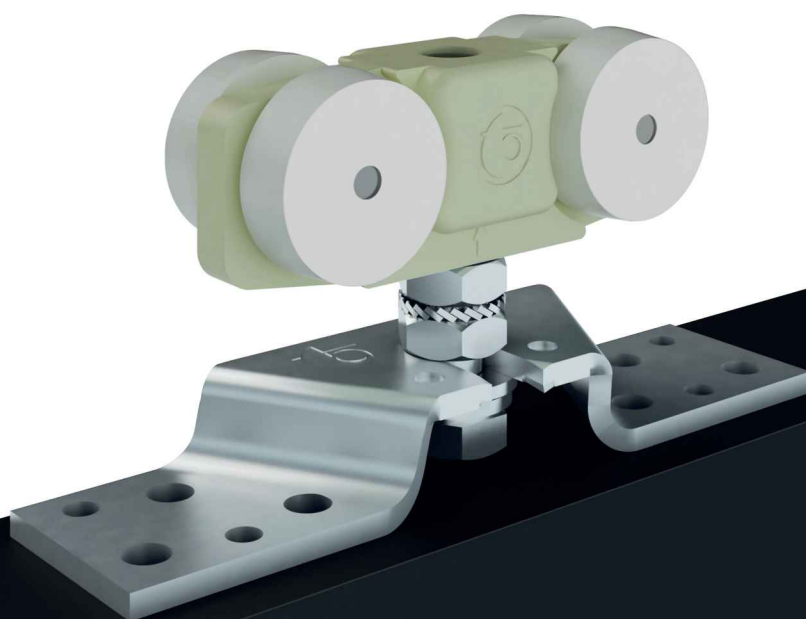

MILCASA
S T O R E

Accordion

Accordion door
Porta pieghevole a fisarmonica



Accordion

Accordion folding doors with hinges and central sliding panel.

Porte pieghevoli a fisarmonica tramite cardini e scorrevole centrale.



Accordion system is dedicated to **multiple leaves folding doors**, combinable with pivot joints or hinges.

The system allows a configuration of **three or four leaves**.

The **sliding system is fixed in centrally to each leaf**, in order to grant an always balanced motion.







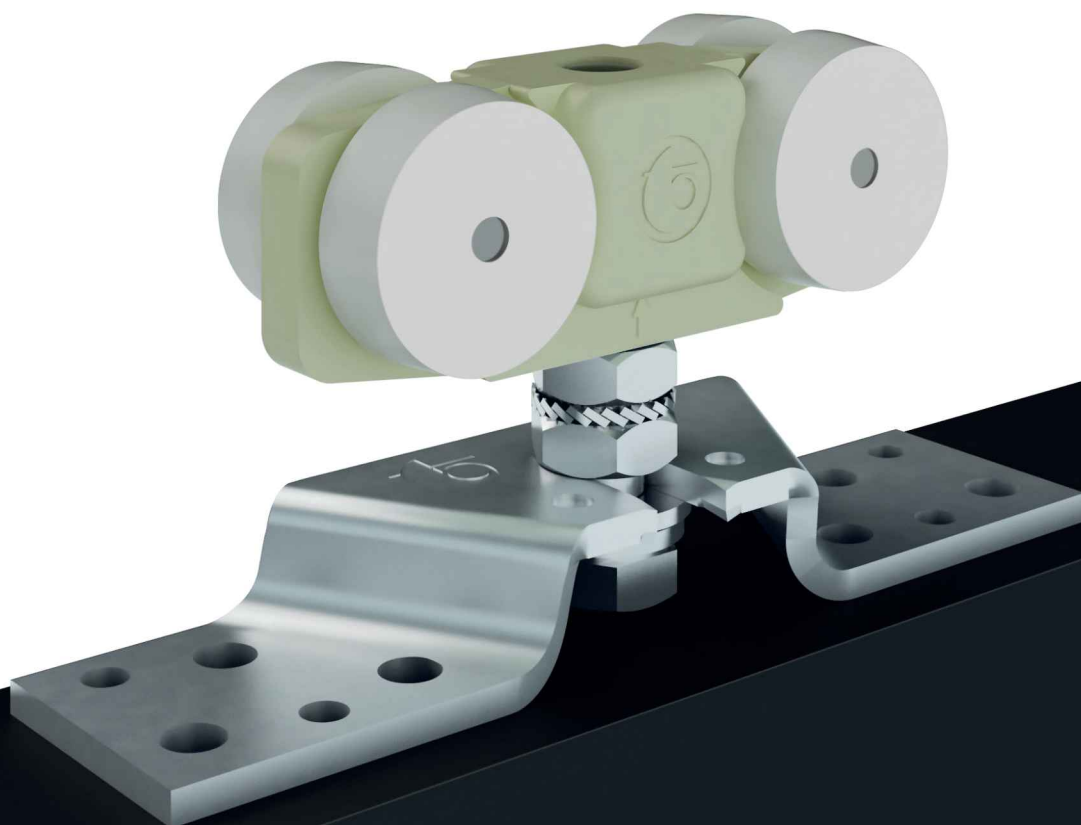

Accordion è il sistema per **porte a fisarmonica pieghevoli** ad ante multiple, utilizzabile con cardini o cerniere.

Il sistema permette una **configurazione a tre o a quattro porte**.

Lo **scorrevole** viene **fissato centralmente**, per il corretto bilanciamento delle ante.



Accordion COMPLETE BOX KIT / KIT COMPLETO IN SCATOLA 

K		Complete kit / Kit completo	
0223		N° 4 Doors N° 4 Porte	
0224		N° 3 Doors N° 3 Porte	
		1	 With hinges - ART. 1138 Con cardini - ART. 1138
		2	 With hinges - ART. 1148 Con cardini - ART. 1148
		3	 With hinges - ART. 1751 Con cerniere - ART. 1751
		4	 With hinges - ART. 1753 Con cerniere - ART. 1753
		5	 With hinges - ART. 1755 Con cerniere - ART. 1755
		6	 With hinges - ART. 1757 Con cerniere - ART. 1757

EXAMPLE / ESEMPIO

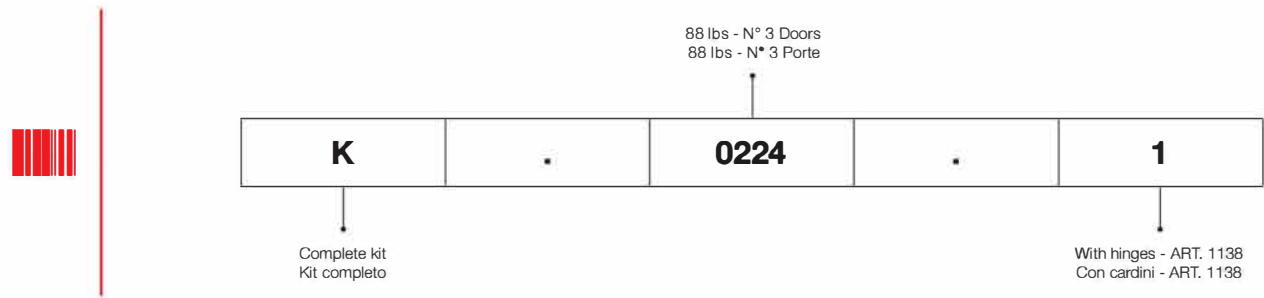

Tracks / Binari ALUMINUM FINISHES CODES / CODICI FINITURE ALLUMINIO 

CODE / CODICE	FINISH COLOR / COLORE FINITURA
8 00 0.0	 00 G Row - Mill Finish / Neutro - Grezzo
8 01 0.0	 01 A Anodized Silver / Argento STANDARD

Accordion

Accordion door
Porta pieghevole a fisarmonica

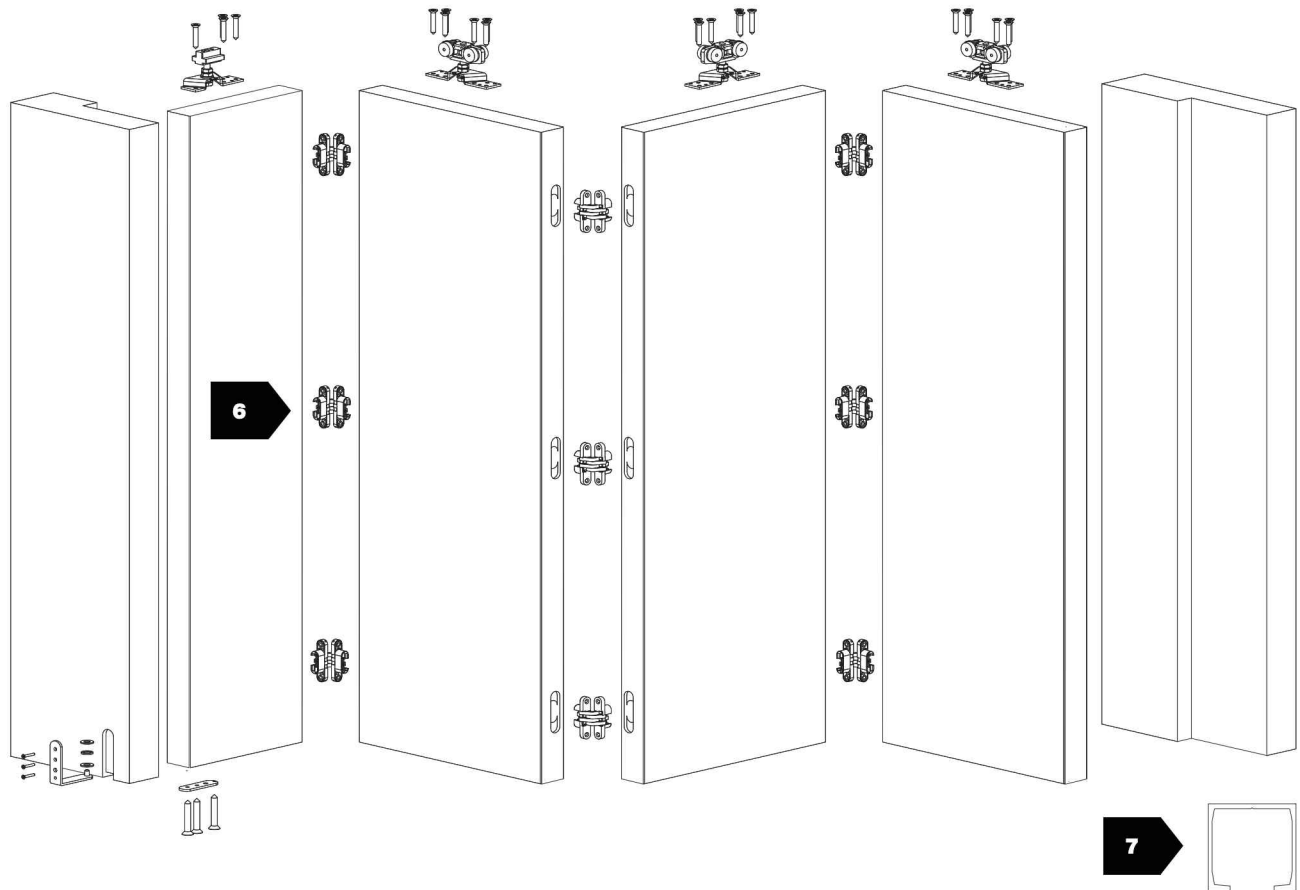
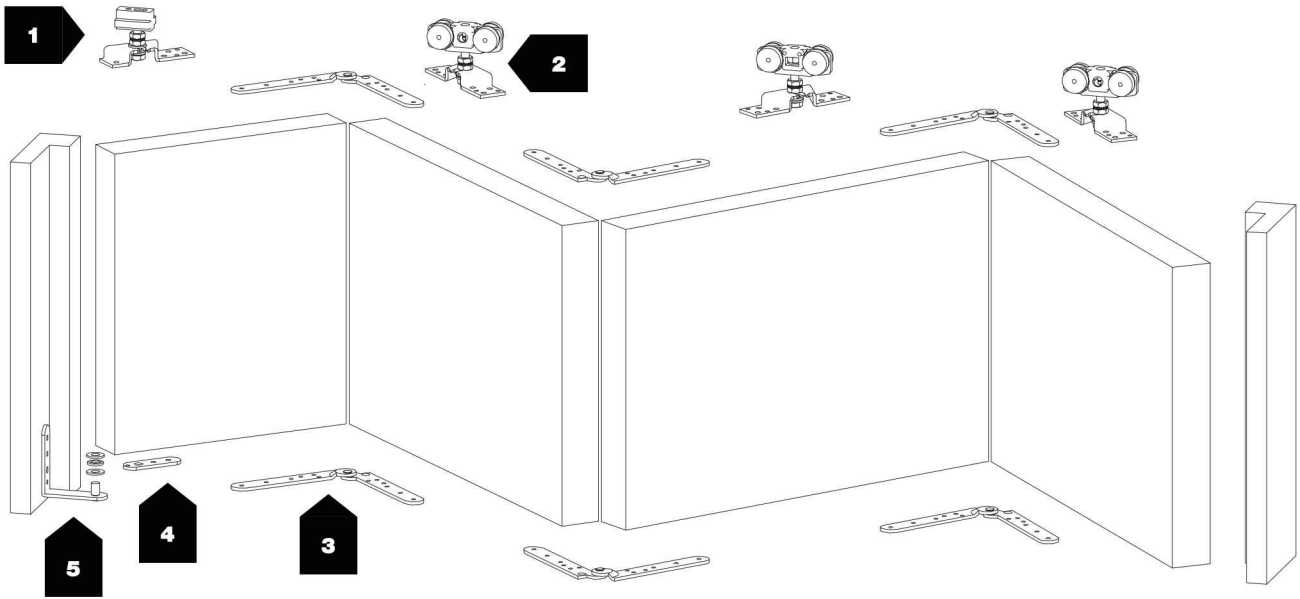







Min. 1 3/16"

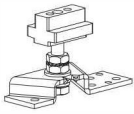
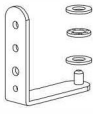
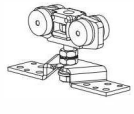
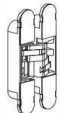

88 lbs

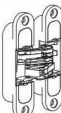

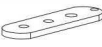
3/16"

N°	Barcode		kg		N°	Barcode		kg	
1	1188		88 lbs		5	1187		88 lbs	
2	1189		88 lbs		6	1751/N		88 lbs	
3	1138		88 lbs			1753/N		88 lbs	
	1148		88 lbs			1755/N		88 lbs	
4	1186		88 lbs			1757/PI		88 lbs	
					7	1080 8 00 0.01080 8 01 0.01080		88 lbs	

Accordion

Accordion door
Porta pieghevole a fisarmonica

88 lbs
(each door / per porta)

3 doors
3 porte

With hinges
Con cardini

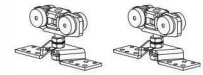
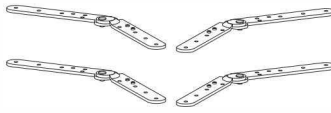
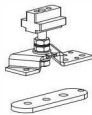
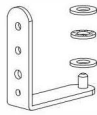

OLD CODE	NEW CODE		
1188/1138/3P	K.0224.1	Close up doors / Ante ravvicinate	4x
1188/1148/3P	K.0224.2	Spaced doors / Ante distanziate	4x

88 lbs
(each door / per porta)

4 doors
4 porte

With hinges
Con cardini

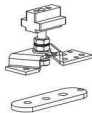
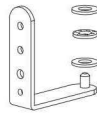

OLD CODE	NEW CODE		
1188/1138/4P	K.0223.1	Close up doors / Ante ravvicinate	4x
1188/1148/4P	K.0223.2	Spaced doors / Ante distanziate	4x

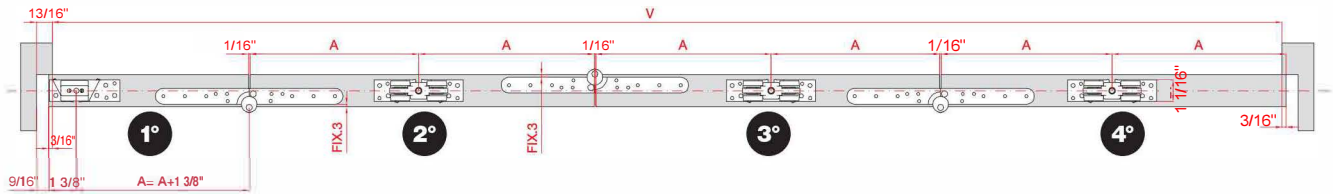

DRILLING / FORATURA



ART.1080

8 00 0 .01080

8 01 0 .01080

3 DOORS / PORTE - 40 KG (EACH DOOR / PER PORTA)
A=V+3/16"+3/16"-1/16"-1/16"-1 3/8":5



4 DOORS / PORTE - 40 KG (EACH DOOR / PER PORTA)
A= V+3/16"+3/16"- 1/16" 1/16" 13/8":7

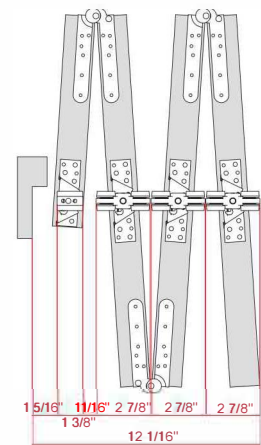

COMPOSITION FOR ACCORDION DOORS / COMPOSIZIONI PER PORTE A FISARMONICA

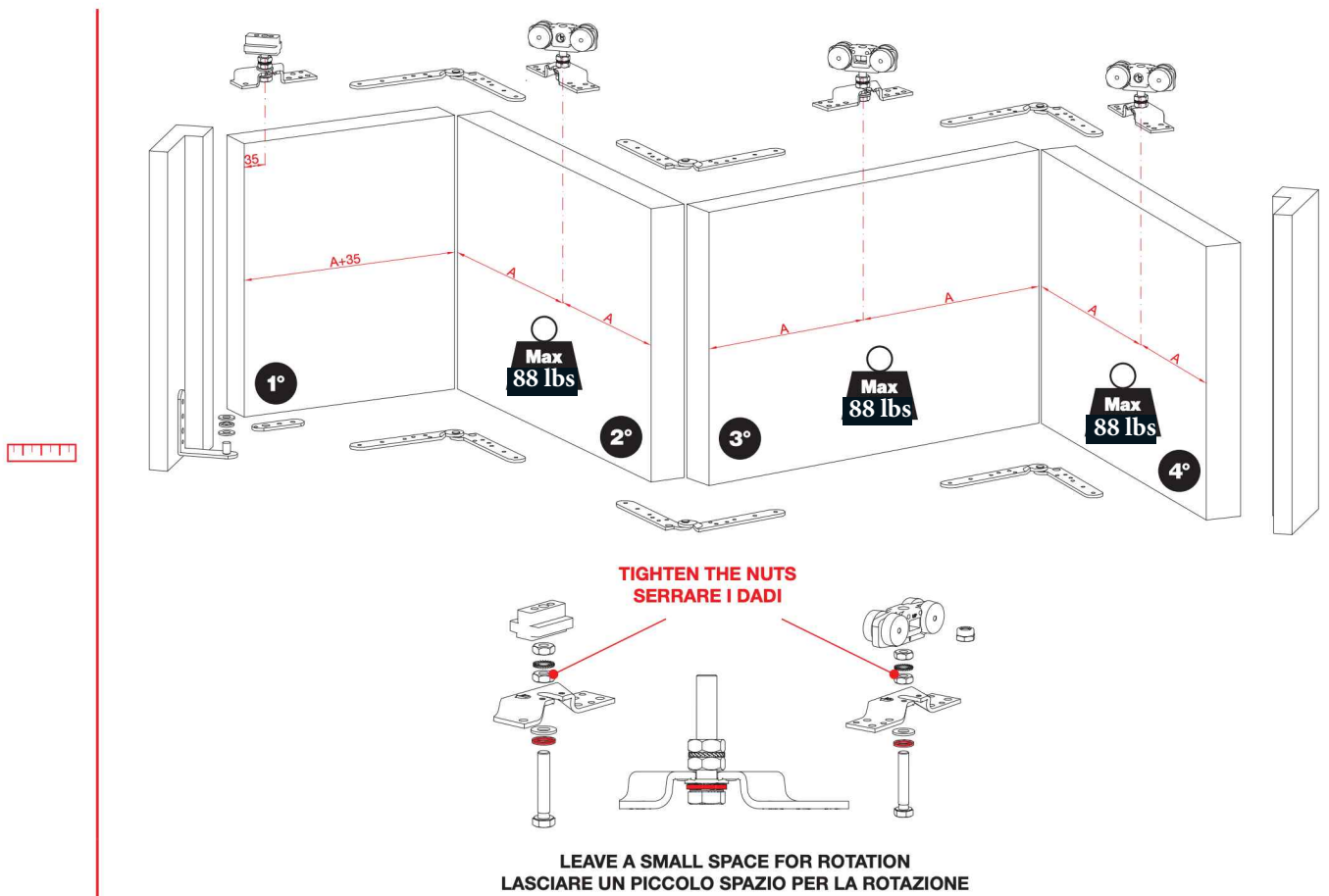
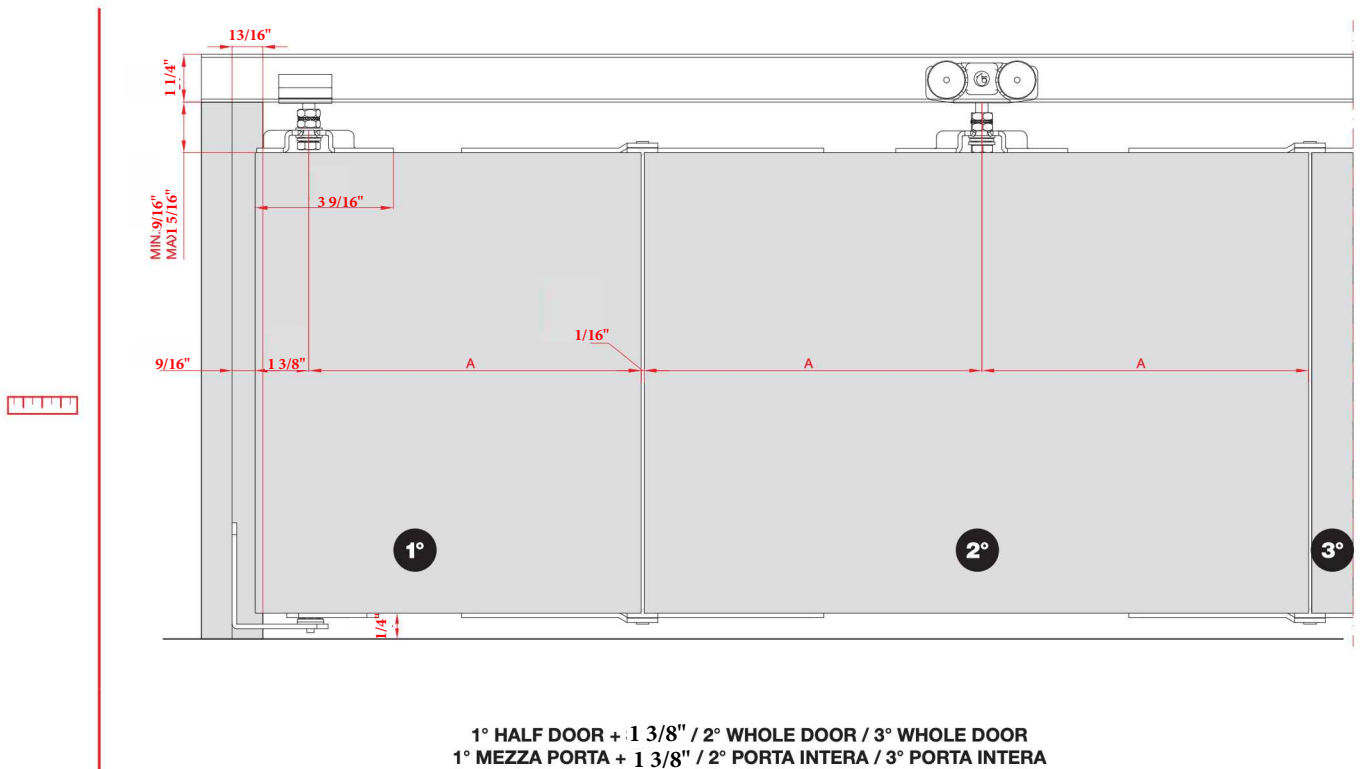

DIAGRAM FOR MOUNTING ACCESSORIES / SCHEMA DI MONTAGGIO ACCESSORI



Accordion

Accordion door
Porta pieghevole a fisarmonica



88 lbs
(each door / per porta)



3 doors
3 porte



With hinges
Con cerniere

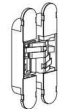
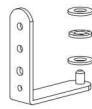

N°6
HINGES / CERNIERE ART. 1751



N°2

OLD CODE	NEW CODE	
1188/1751/N/3P	K.0224.3	4x

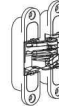
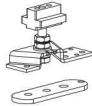
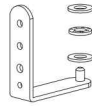

N°6
HINGES / CERNIERE ART. 1753



N°2

OLD CODE	NEW CODE	
1188/1753/N/3P	K.0224.4	4x

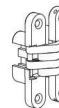
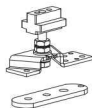
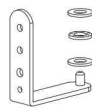

N°6
HINGES / CERNIERE ART. 1755



N°2

OLD CODE	NEW CODE	
1188/1755/N/3P	K.0224.5	4x

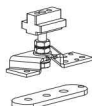
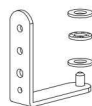

N°6
HINGES / CERNIERE ART. 1757



N°2

OLD CODE	NEW CODE	
1188/1757/PI/3P	K.0224.6	4x



88 lbs
(each door / per porta)



4 doors
4 porte



With hinges
Con cerniere

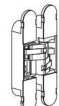
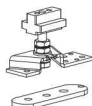
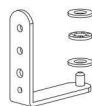

N°9
HINGES / CERNIERE ART. 1751



N°3

OLD CODE	NEW CODE	
1188/1751/N/4P	K.0223.3	4x

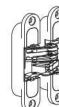
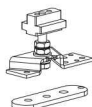
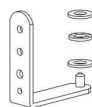

N°9
HINGES / CERNIERE ART. 1753



N°3

OLD CODE	NEW CODE	
1188/1753/N/4P	K.0223.4	4x

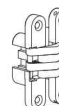
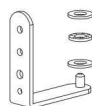

N°9
HINGES / CERNIERE ART. 1755



N°3

OLD CODE	NEW CODE	
1188/1755/N/4P	K.0223.5	4x

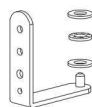

N°9
HINGES / CERNIERE ART. 1757



N°3

OLD CODE	NEW CODE	
1188/1757/PI/4P	K.0223.6	4x

COMPOSITION FOR ACCORDION DOORS / COMPOSIZIONI PER PORTE A FISARMONICA

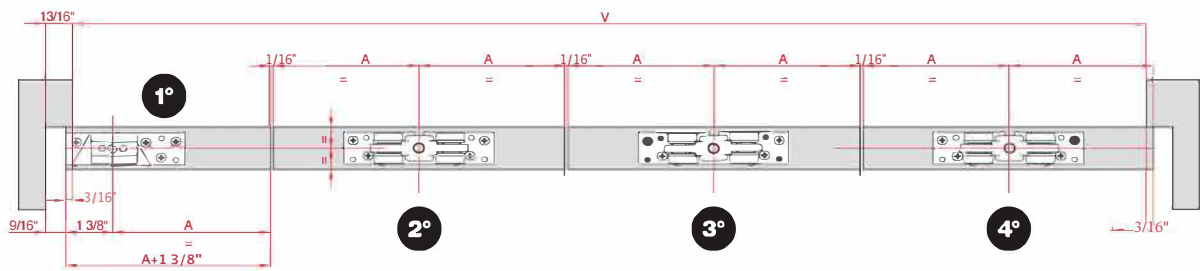
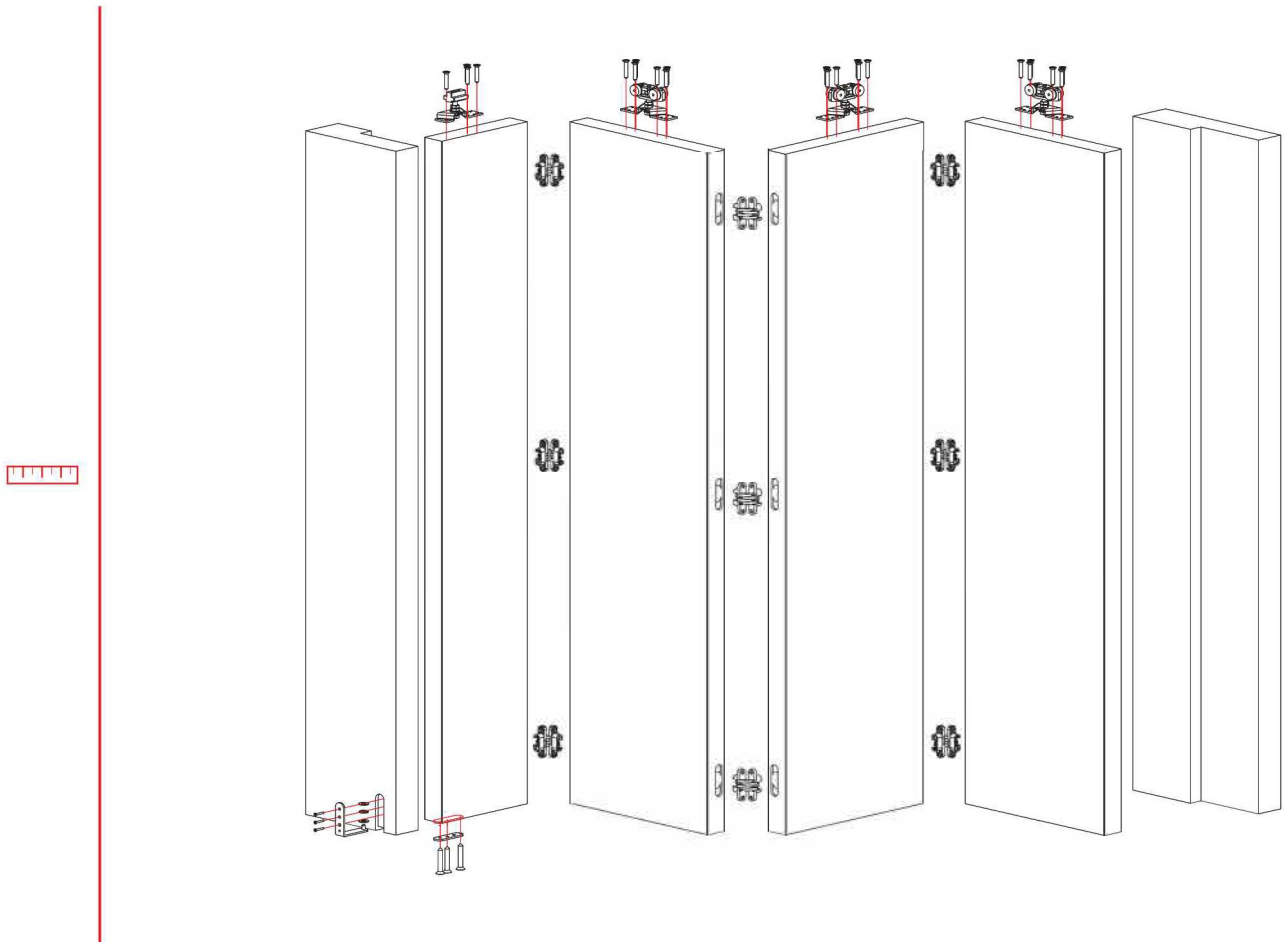

DRILLING / FORATURA



ART.1080

8 00 0.01080

8 01 0.01080



3 DOORS / PORTE - 40 KG (EACH DOOR / PER PORTA)
 $A = V + 3/16'' + 3/16'' - 1/16'' - 1/16'' - 1\ 3/8'' : 5$



4 DOORS / PORTE - 40 KG (EACH DOOR / PER PORTA)
 $A = V + 3/16'' + 3/16'' - 1/16'' - 1/16'' - 1/16'' - 1\ 3/8'' : 7$



Milcasa Store

www.milcasastore.com
support@milcasastore.com

(888) MILCASA
(888) 645-2272