

! CLOSE THE DOOR SLOWLY AT FIRST AUTOMATIC LOAD AFTER INSTALLATION

CHIUDERE LA PORTA LENTAMENTE AL PRIMO CARICAMENTO AUTOMATICO DOPO L'INSTALLAZIONE

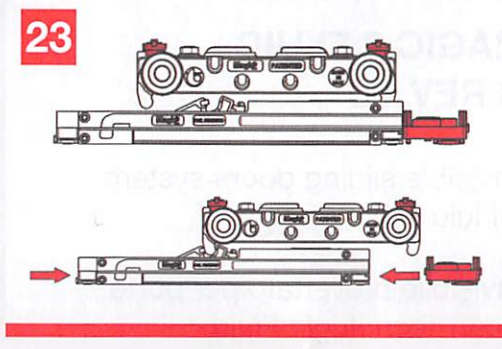

! IN ORDER TO ADJUST DOOR POSITIONING IT IS POSSIBLE TO MOVE THE DAMPER

PER REGOLARE LA POSIZIONE DELLA PORTA E' POSSIBILE SPOSTARE L'AMMORTIZZATORE

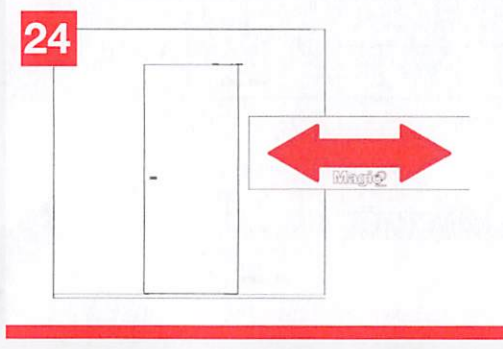

! RECOMMENDED FOR APPLICATIONS IN PUBLIC SPACES, HOTELS AND RESIDENCES

RACCOMANDATO L'UTILIZZO PER APPLICAZIONI IN SPAZI PUBBLICI, HOTEL E RESIDENCE

ACCESSORIES PLACEMENT (STANDARD POSITION) / POSIZIONAMENTO DEGLI ACCESSORI (POSIZIONE STANDARD)

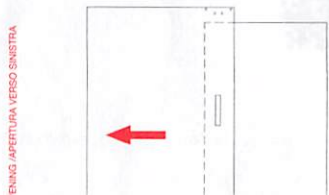

B = 0 mm (Min.)
B = 50 mm (Suggested/Suggerito)

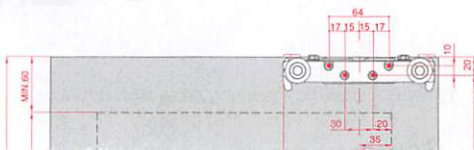

ACCESSORIES PLACEMENT (TOTAL OPENING POSITION) / POSIZIONAMENTO DEGLI ACCESSORI (POSIZIONE APERTURA TOTALE)

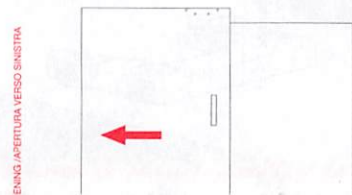

B = 0 mm (Min.)
B = 50 mm (Suggested/Suggerito)

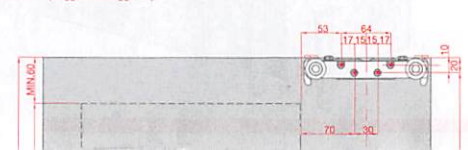

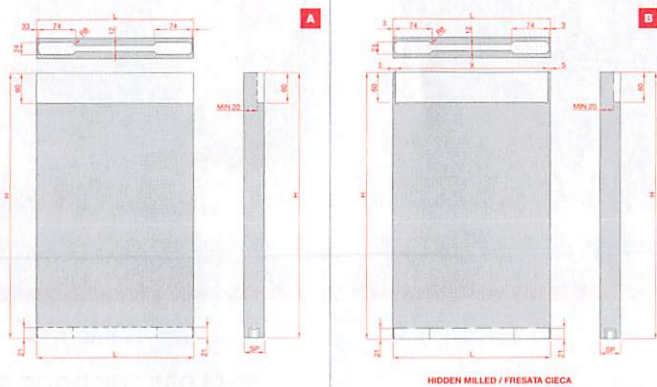

HIDDEN MILLED / FRESATA CIECA

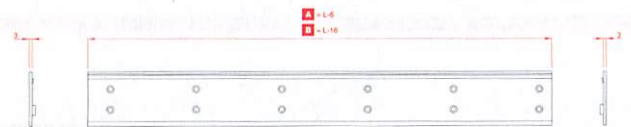
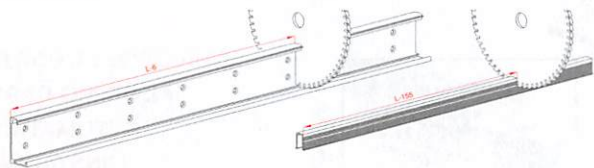

ART. 2851

ART. 2850

ART. 2851



ART. 2858



ART. 121



ART. 2858

1

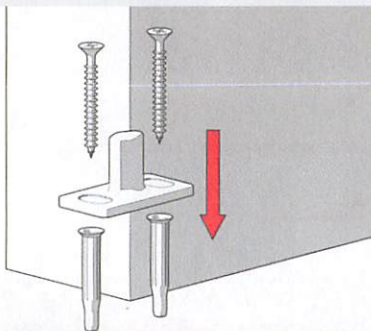

2

OPTIONAL

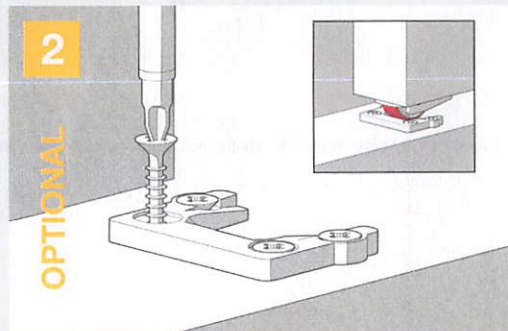

Magic²

WITH FLUID[®]
TECHNOLOGY

MOD. SYSTEM MAGIC 2 FLUID
7002.06983 REV. 00

Magic² is the new panted and invisible sliding doors system outside the wall with Fluid Technology

Magic² è l'innovativo sistema invisibile brevettato per porte scorrevoli esterno muro con Tecnologia Fluid



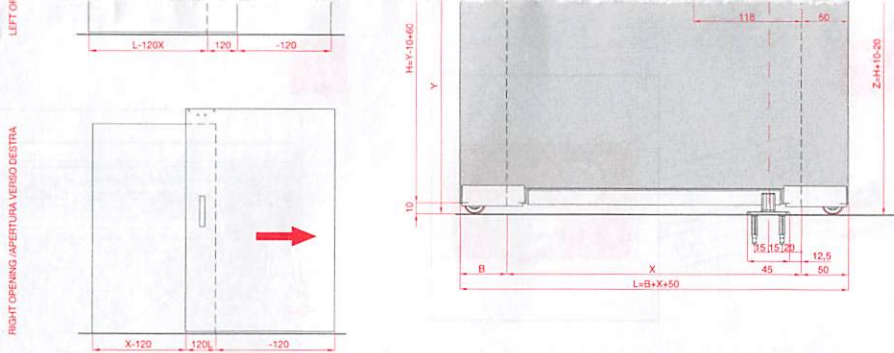

MAGIC2/1100 (K.0031.1.01)

B=0
X= MIN. 800 (L=850)
X= MAX. 1050 (L=1100)

B=50
X= MIN. 800 (L=900)
X= MAX. 1000 (L=1100)

MAGIC2/1800 (K.0031.2.01)

B=0
X= MIN. 800 (L=850)
X= MAX. 1750 (L=1800)

B=50
X= MIN. 800 (L=900)
X= MAX. 1700 (L=1800)

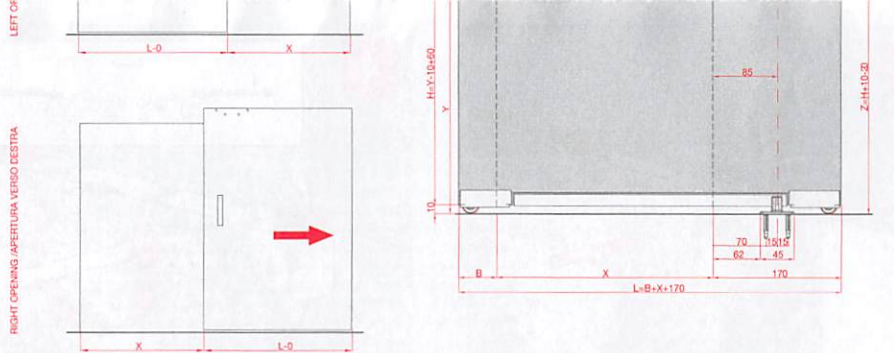

MAGIC2/1100 (K.0031.1.01)

B=0
X= MIN. 680 (L=850)
X= MAX. 930 (L=1100)

B=50
X= MIN. 680 (L=900)
X= MAX. 880 (L=1100)

MAGIC2/1800 (K.0031.2.01)

B=0
X= MIN. 680 (L=850)
X= MAX. 1630 (L=1800)

B=50
X= MIN. 680 (L=900)
X= MAX. 1580 (L=1800)

ACCESSORIES PLACEMENT (INTERMEDIATE POSITION) / POSIZIONAMENTO DEGLI ACCESSORI (POSIZIONE INTERMEDIA)

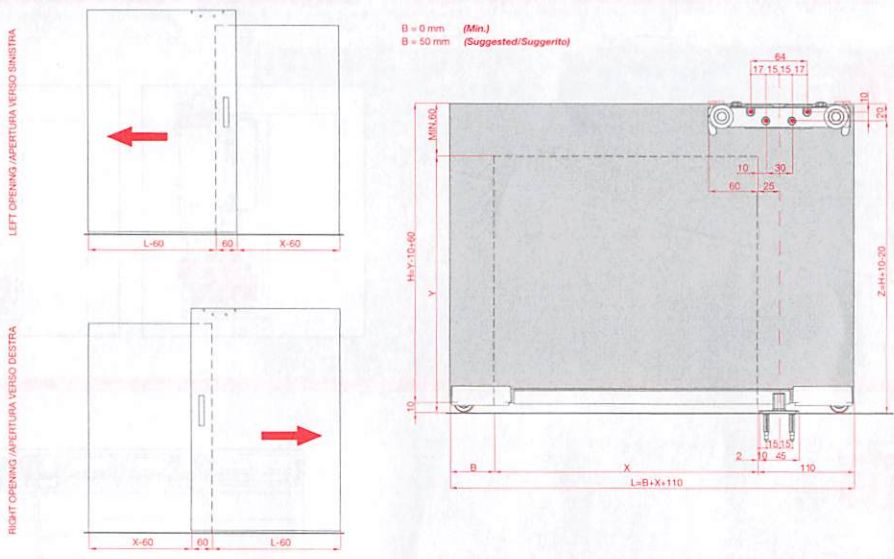

MAGIC2/1100 (K.0031.1.01)

B=0
X= MIN. 740 (L=850)
X= MAX. 990 (L=1100)

B=50
X= MIN. 740 (L=900)
X= MAX. 940 (L=1100)

MAGIC2/1800 (K.0031.2.01)

B=0
X= MIN. 740 (L=850)
X= MAX. 1690 (L=1800)

B=50
X= MIN. 740 (L=900)
X= MAX. 1640 (L=1800)

MEASUREMENTS DESCRIPTION / DESCRIZIONE MISURE

