

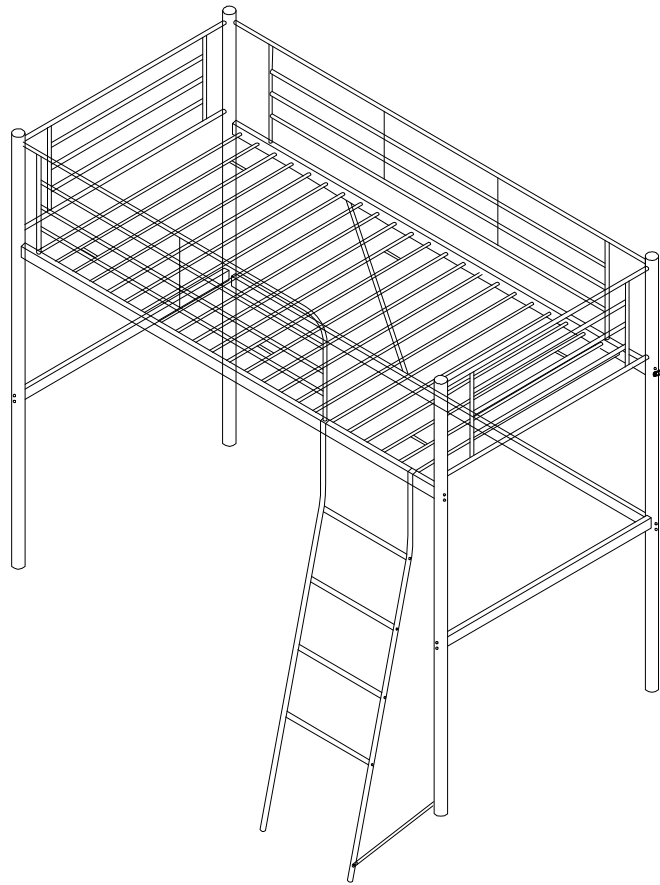

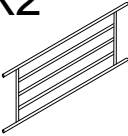

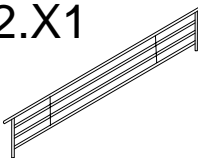

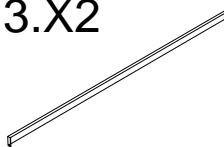



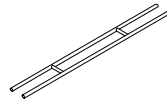



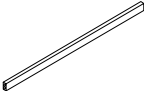
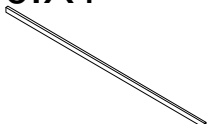

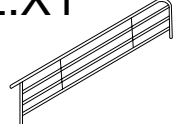



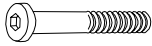
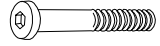





ASSEMBLY INSTRUCTIONS

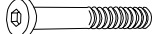
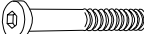

1.X2 	2.X1 	3.X2 	4.X18 	5.X3 	6.X1 
7.X2 	8.X1 	9.X2 	10.X1 	11.X4 	12.X1 
13.X2 	14.X1 	15.X1 	16.X1 	A.X8  M8X65mm	B.X7  M6X65mm
C.X8  M6X35mm	D.X1  M6X45mm	E.X23  M6X16mm	G.X10  M8	H.X4  50	I.X4  25
J.X3 	K.X1  M6	L.X2 	M.X2 	N.X8  M6	O.X2  M8X70mm
P.X8  M6X70mm	QX2   M4X38				

STEP 1

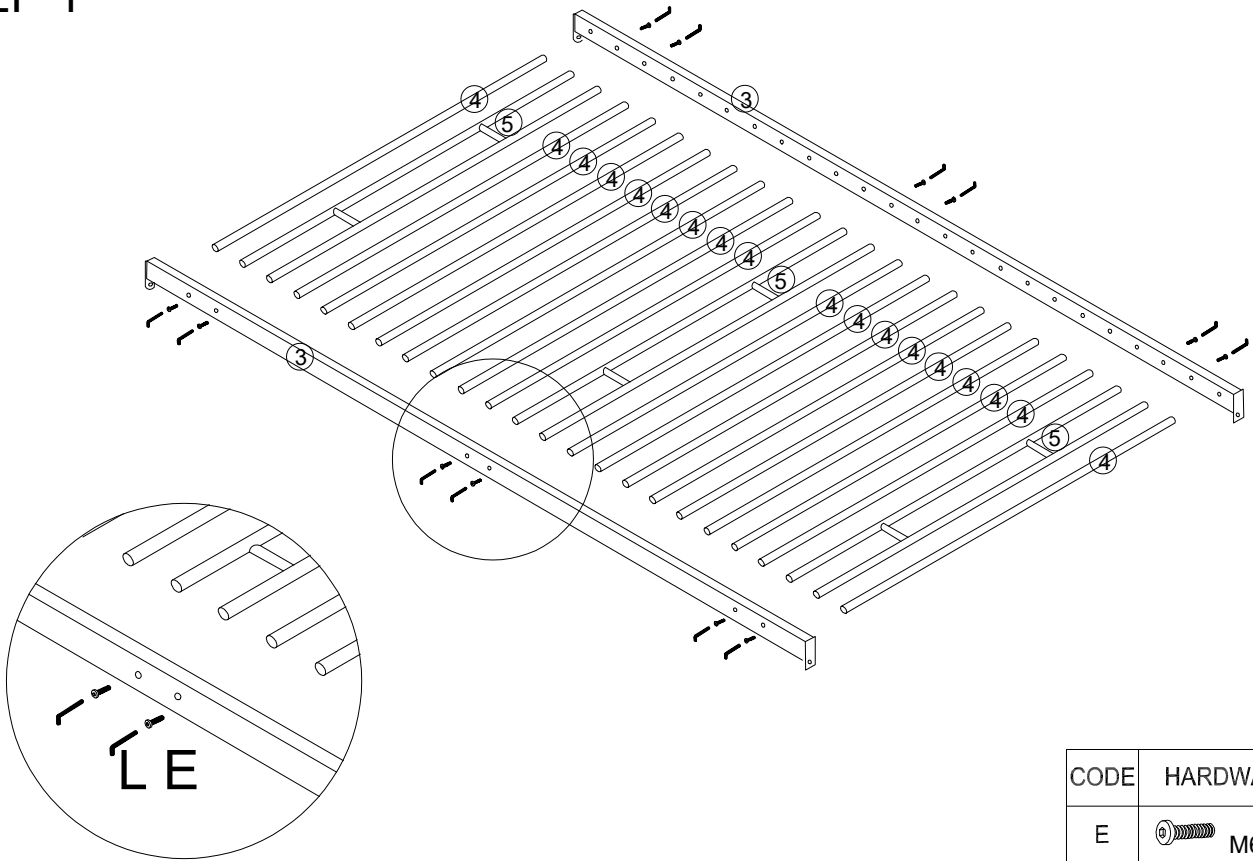

CODE	HARDWARE	QTY
E	M6X16	12
L		1

STEP 2

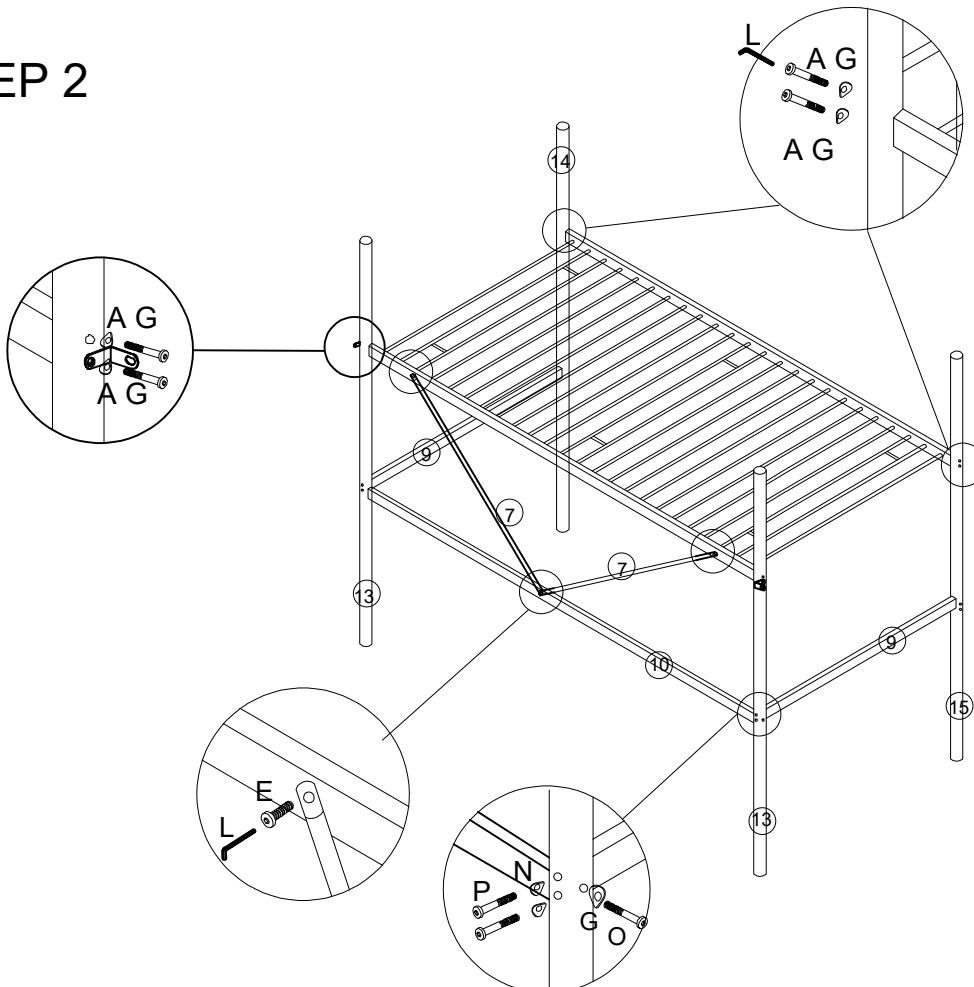

CODE	HARDWARE	QTY
A	M8X65	8
E	M6X16	1
G	M8	10
L		2
N	M6	8
O	M8X70	2
P	M6X70	8

STEP 3

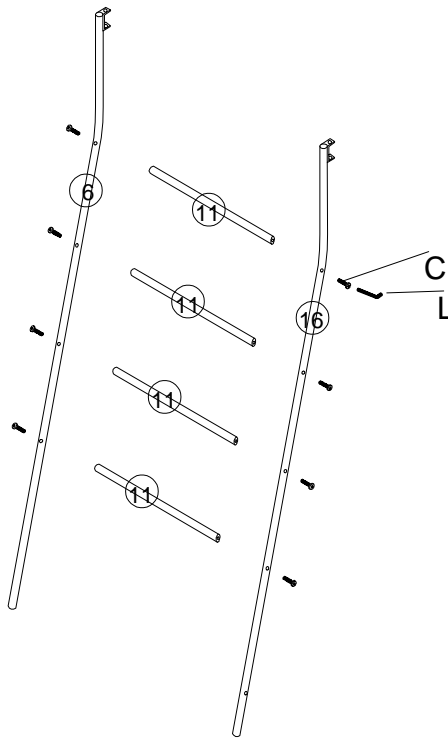

CODE	HARDWARE	QTY
C	M6X35	8
L		1

STEP 4

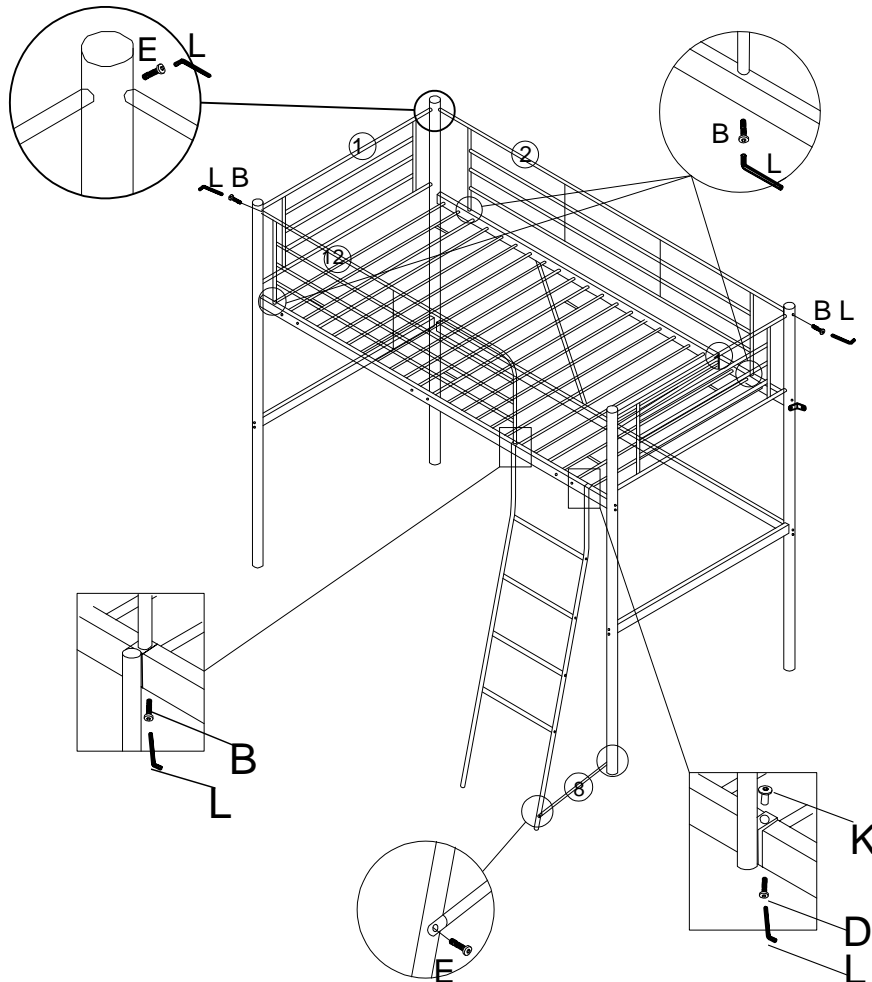

CODE	HARDWARE	QTY
B	M6X65	7
D	M6X45	1
E	M6X16	10
L		1
K	M6	1