

Barcelona Bed 150cm - LFE

JB Antique

Assembly Instructions

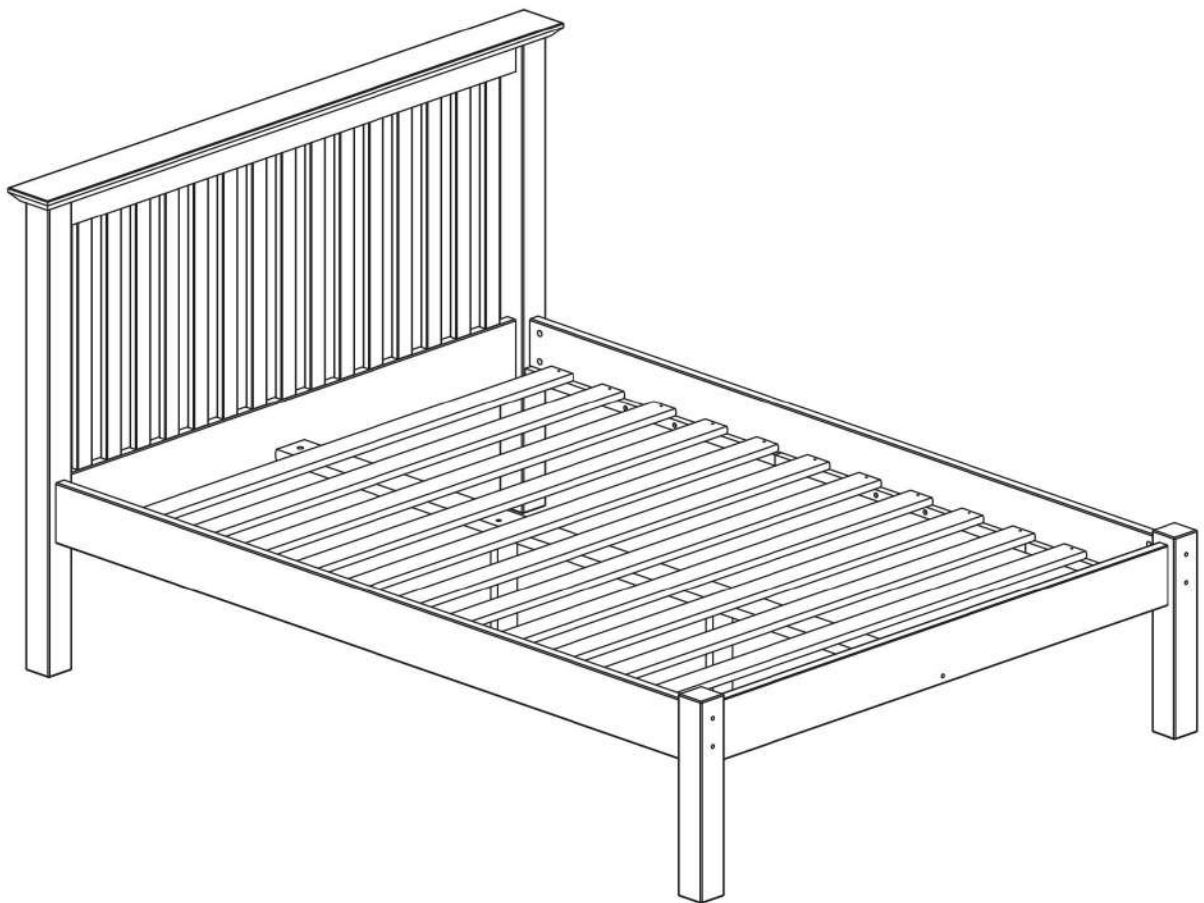

Safety Advice

Please take the time to carefully read through the whole of these instructions before you commence.

Keep these instructions for future reference.

Unpack, inspect and check off all of the contents.

Please dispose of all packaging safely.

Small component parts could choke a child if swallowed.

We strongly recommend that you keep children well away from the work area.

It would be sensible to lay a sheet or blanket on the floor where you intend to work to avoid scratching this product and to protect your floor.

This product is heavy. Take extreme care when lifting to avoid personal injury or damage to the product.

Assemble the product as close to its intended final position in the room as possible.

HANDY HINT: If you keep the hardware in a bowl during assembly you will be less likely to lose them.

HARDWARE

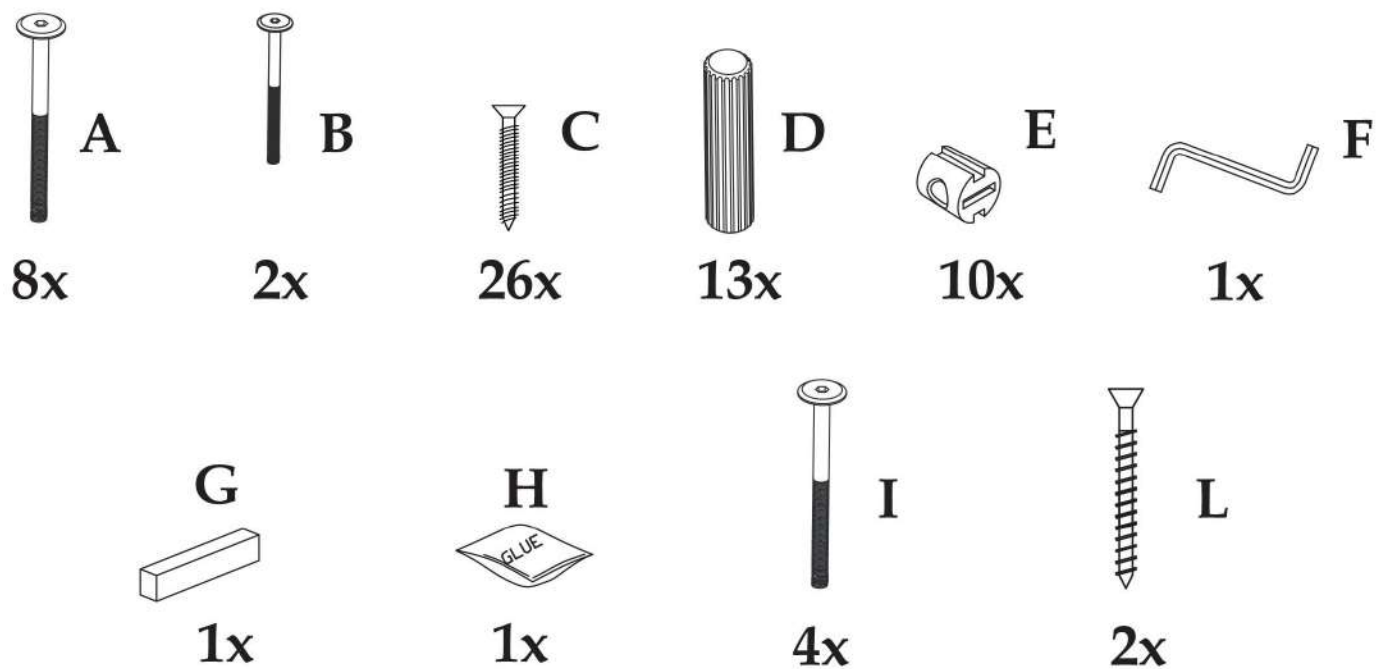

PARTS

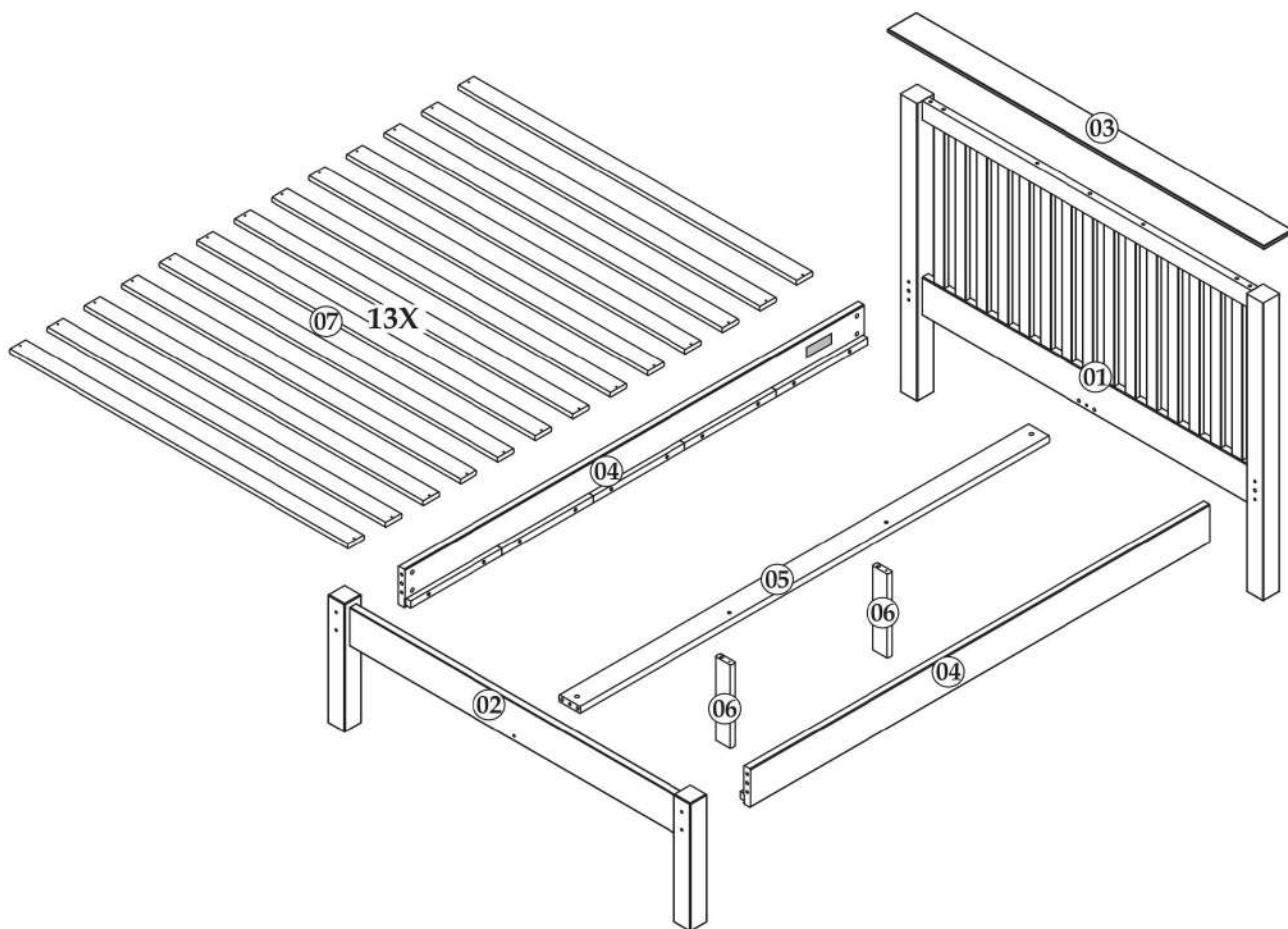

1

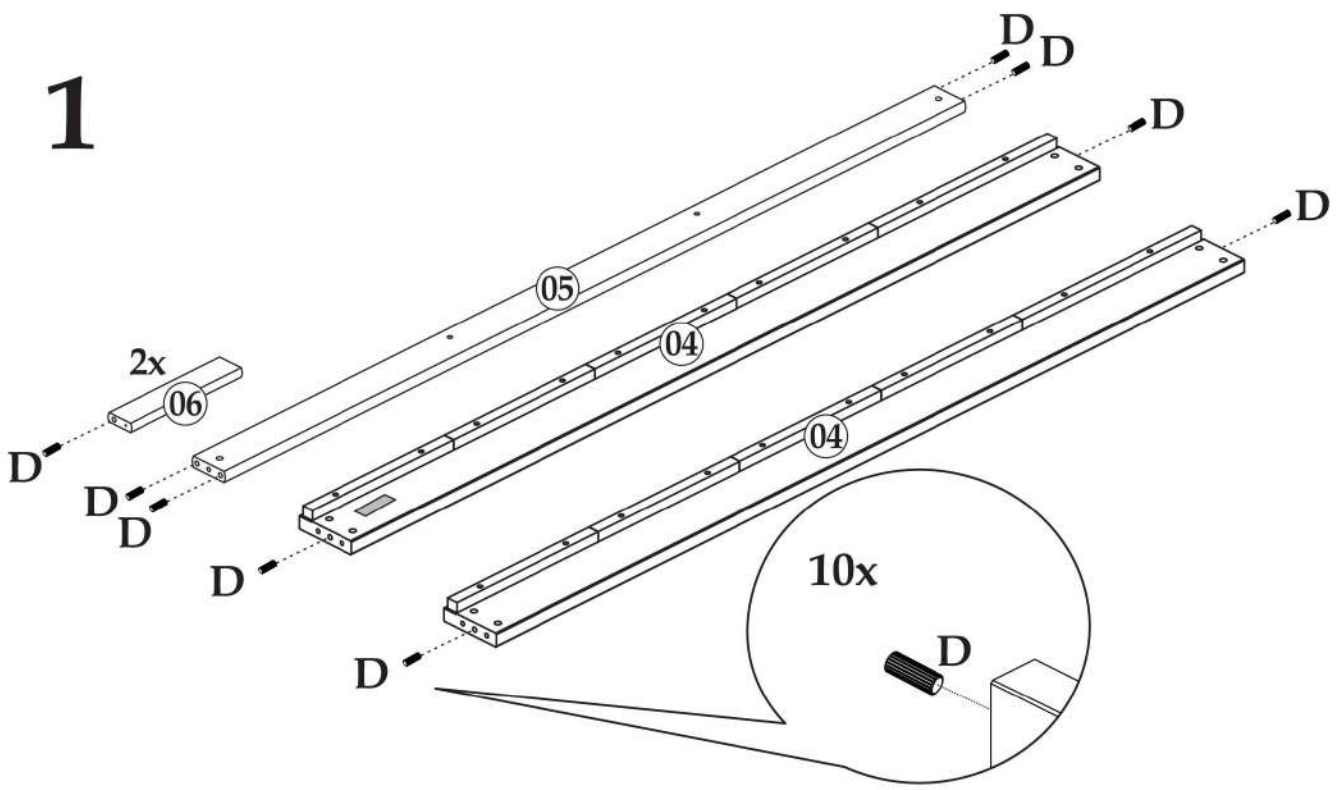

2

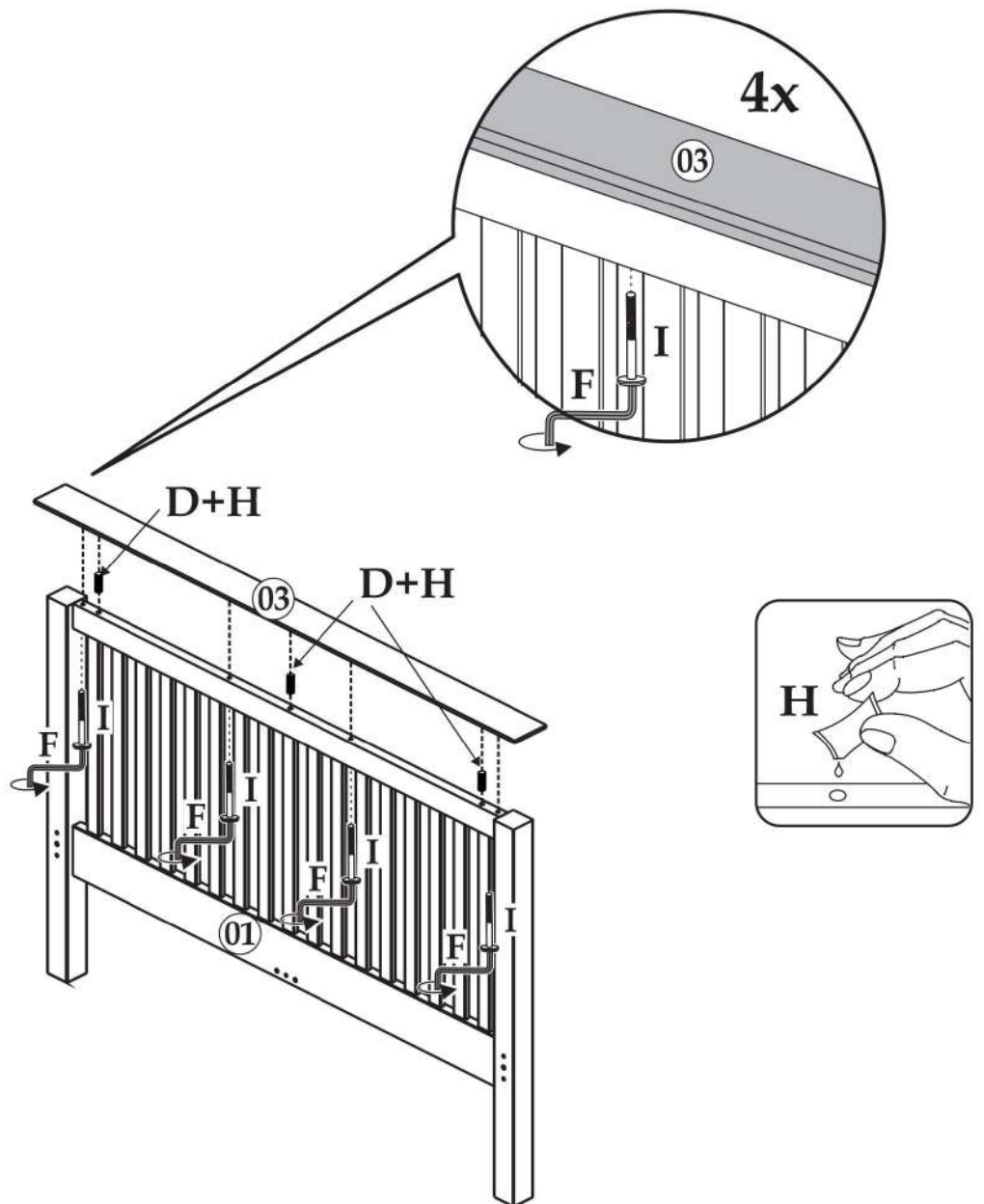

3

Do not completely tighten the bolts at this stage.

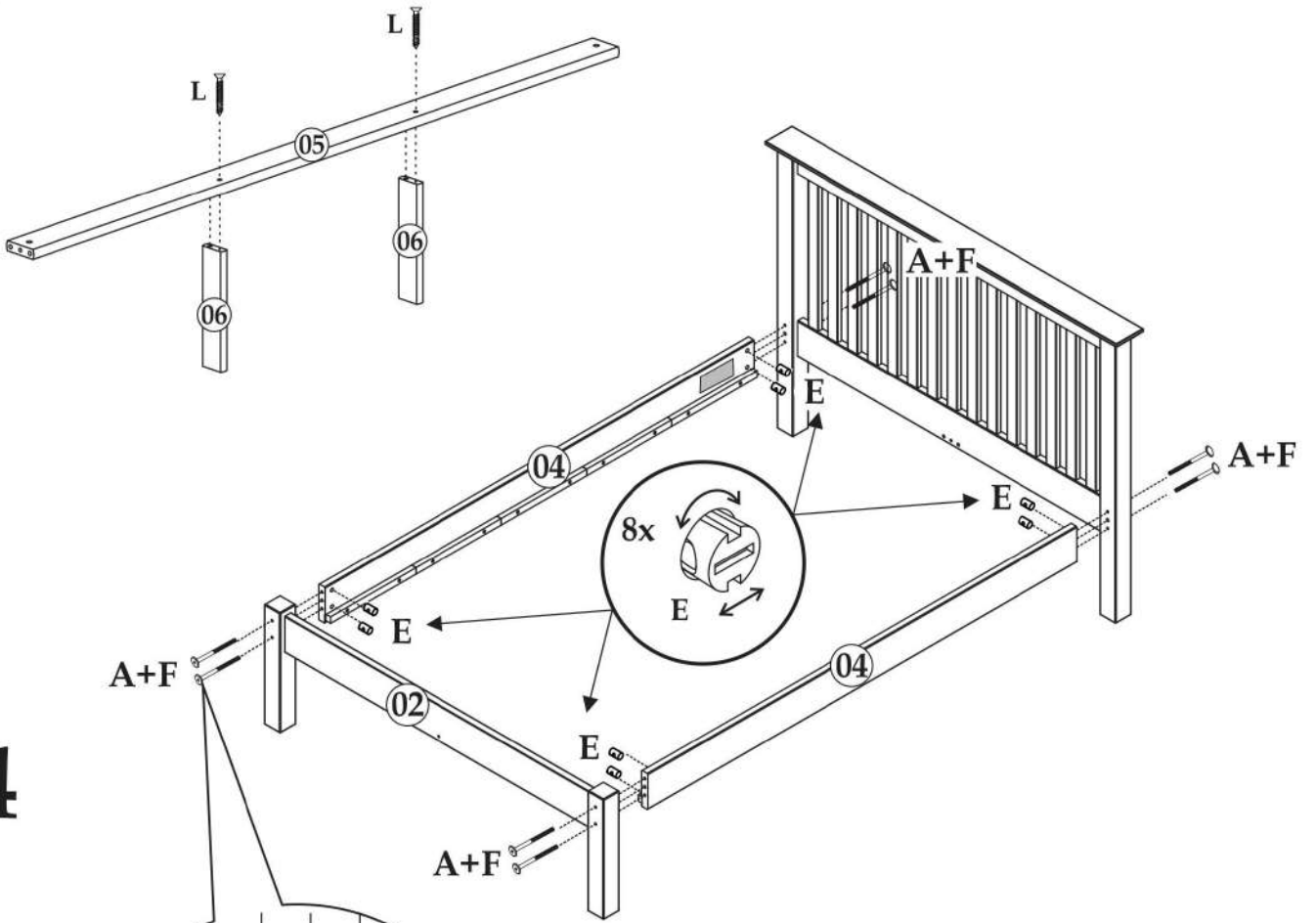

4

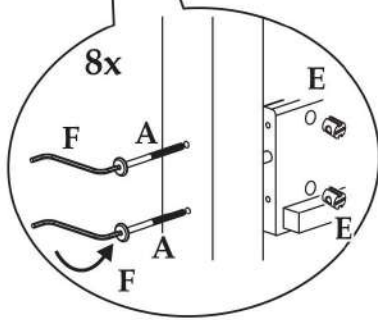

5

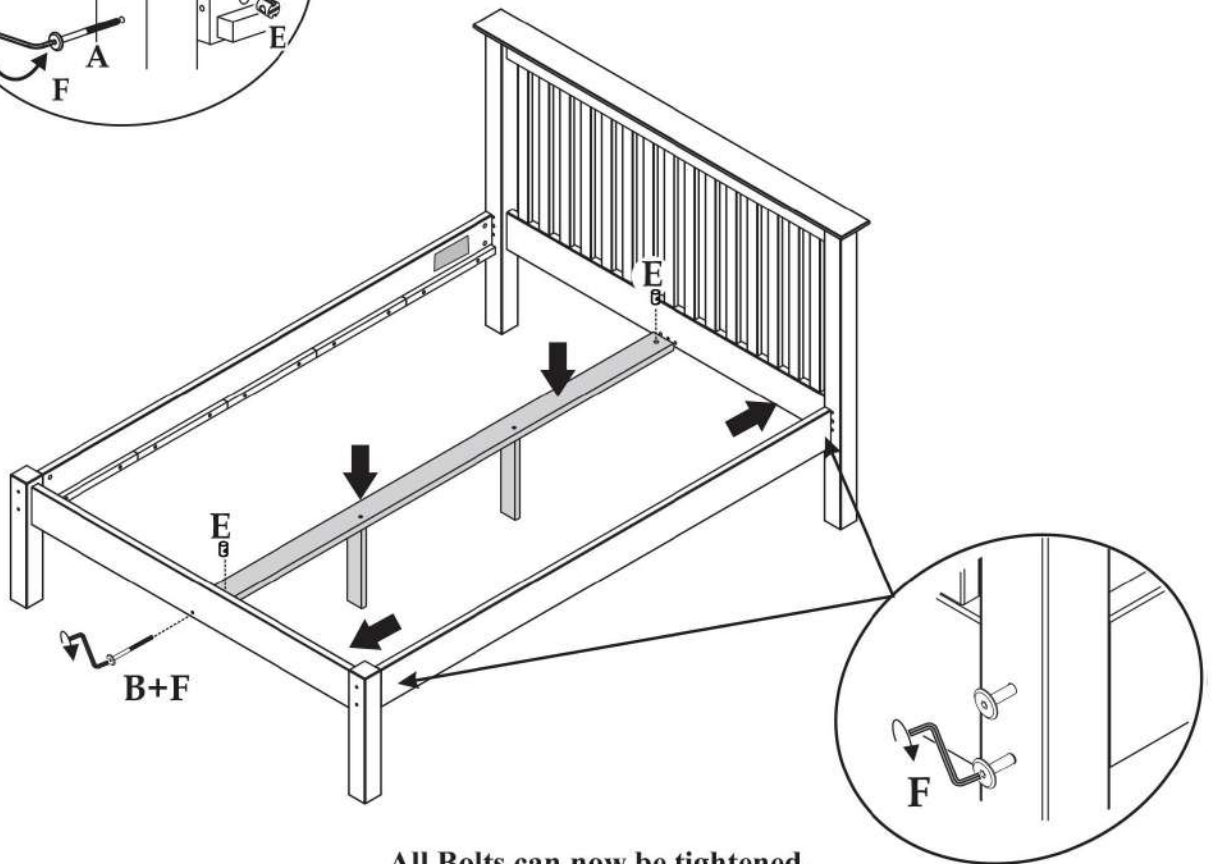

All Bolts can now be tightened.

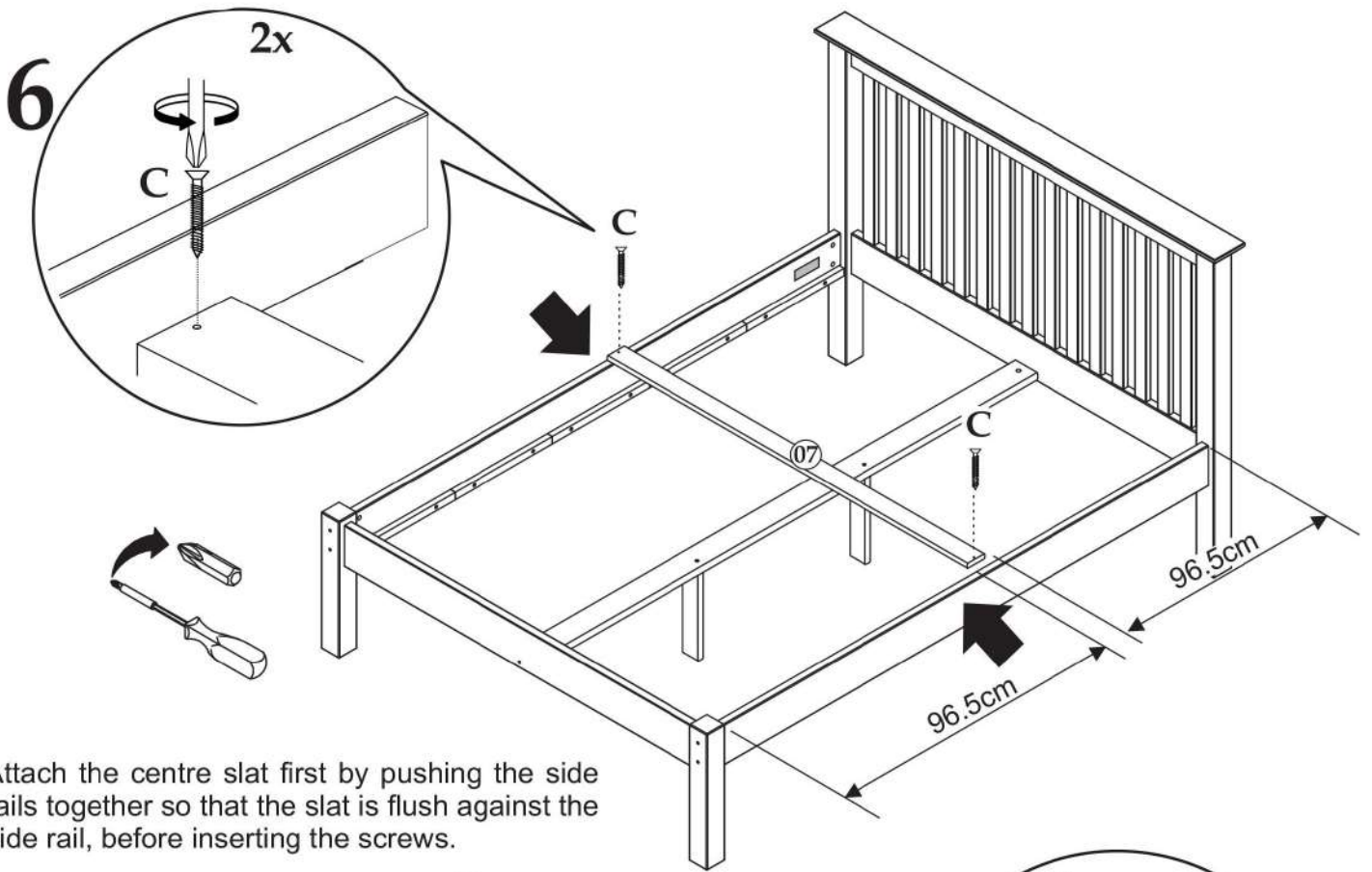

Attach the centre slat first by pushing the side rails together so that the slat is flush against the side rail, before inserting the screws.

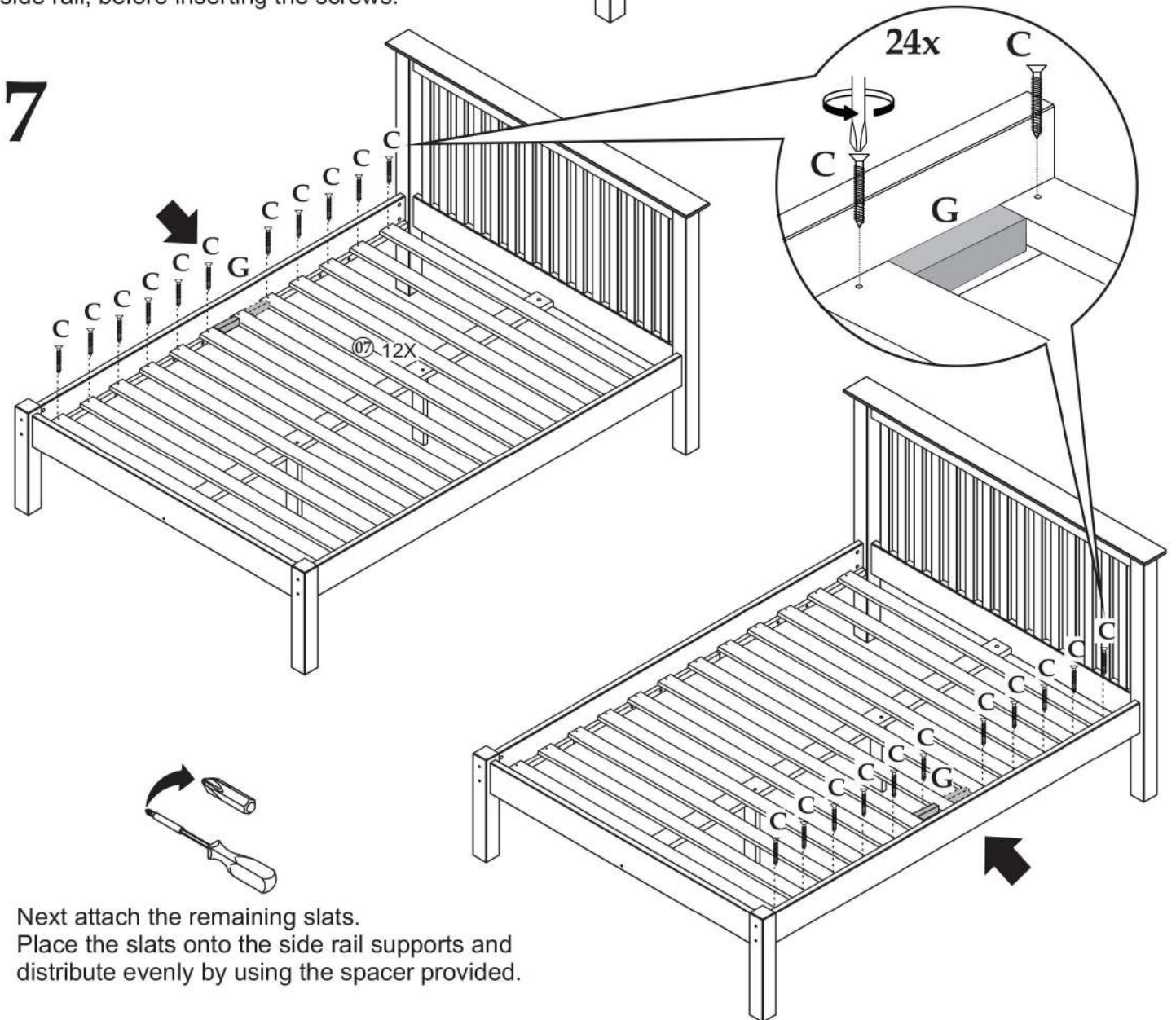

Next attach the remaining slats. Place the slats onto the side rail supports and distribute evenly by using the spacer provided.

General Care

Wipe clean with a slightly damp soft cloth. Avoid the use of all household cleaners and abrasives. When moving your furniture, carefully lift into place. Never drag or push the pieces across the floor as this will cause damage to the joints and could result in failure to the product that will invalidate the warranty.

Recommendations

Periodical re-tightening of fixings.

Warning

This unit is heavy. Please use an assistant when lifting.

Notes

We've tried to make this piece of furniture as easy to assemble as possible.

In the unlikely event that you have problems putting it together or have damaged or missing pieces, please contact our customer services on

Telephone: 01553 615665

Email: support@reinforcedbeds.co.uk

Web: www.reinforcedbeds.co.uk