

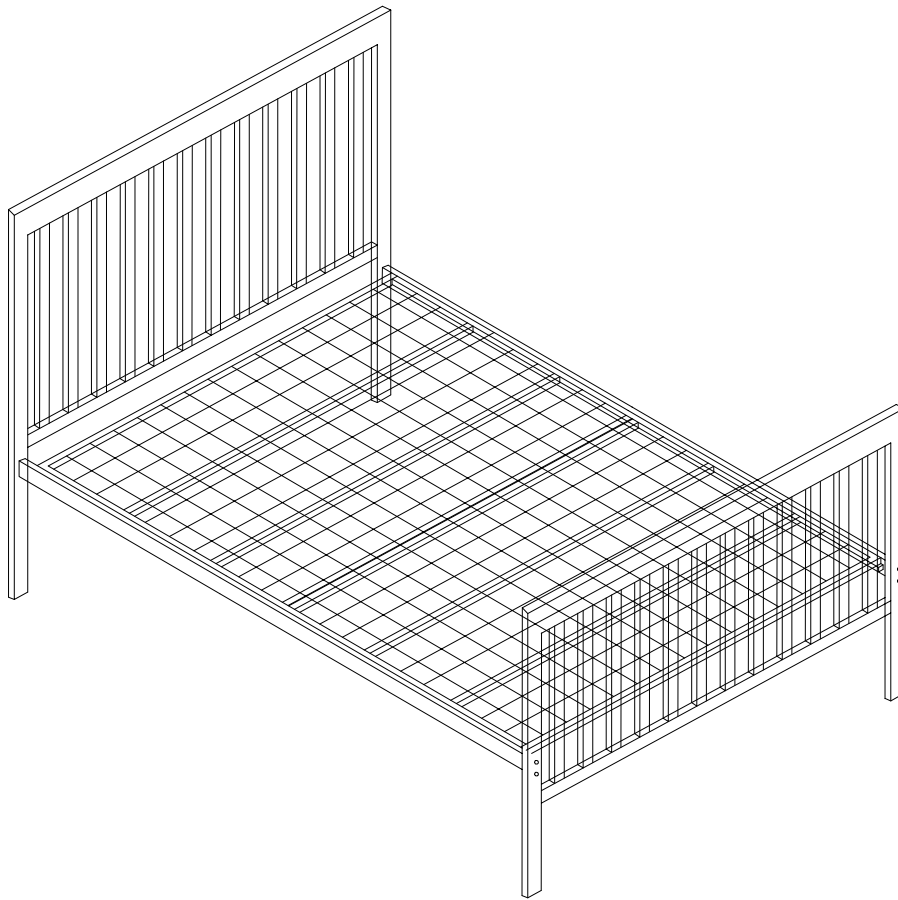

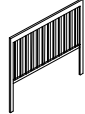





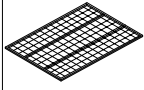

Assembly Instructions: HD Holkham Bed (4'0+4'6)





1		1	4		1
2		1	5		2
3		2			

A		M8X40mm	8
B		M6X16mm	4
C		M8	8
D		M6	8
E			2
F		M6X45mm	8

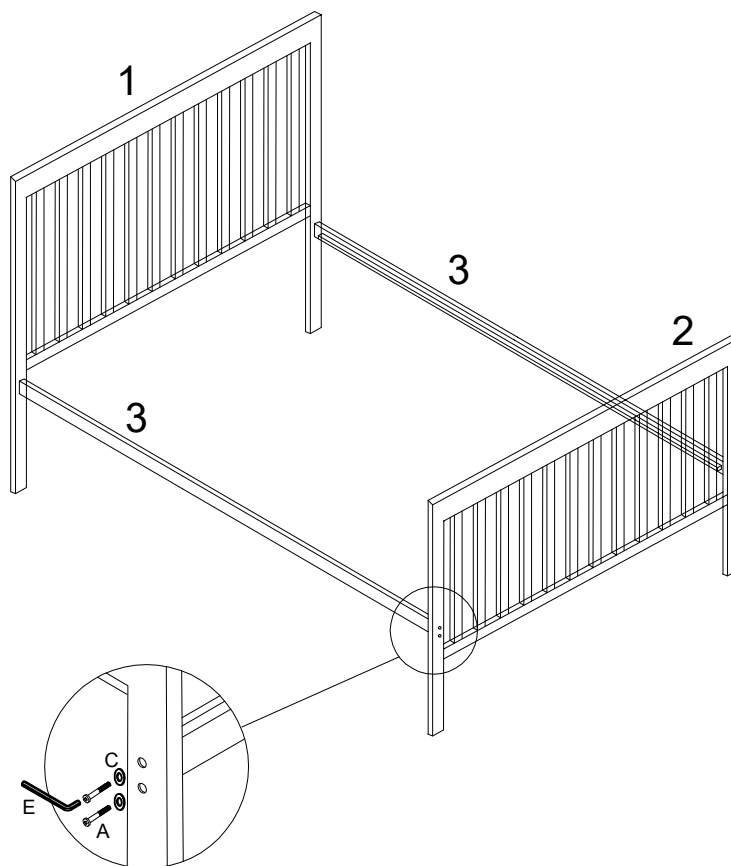
STEP 1



CODE	HARDWARE	QTY
A	 M8X40	8
C	 M8	8
E		1

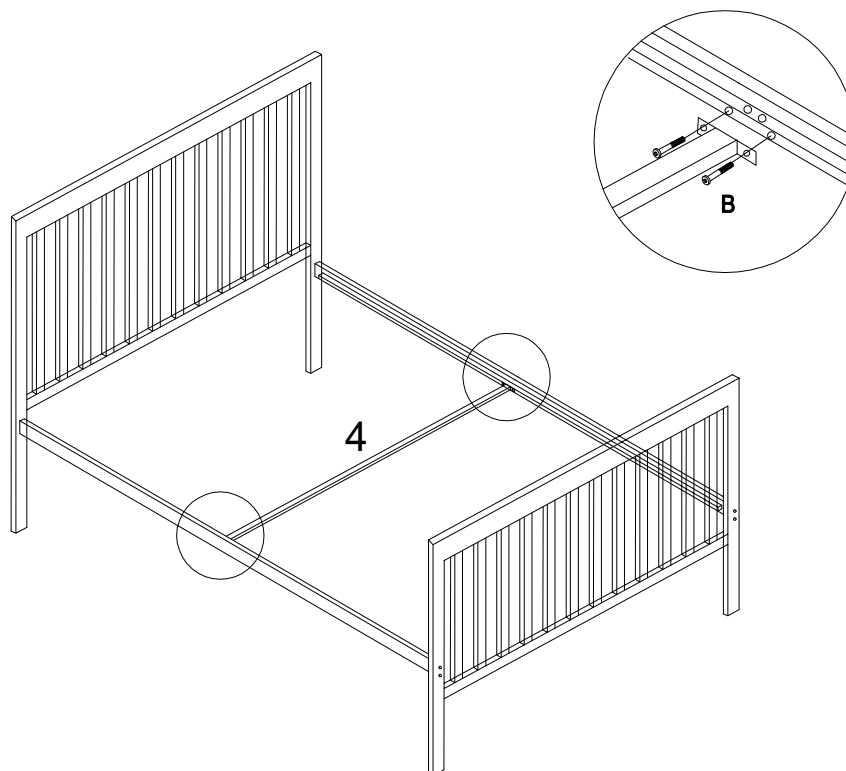

STEP 2

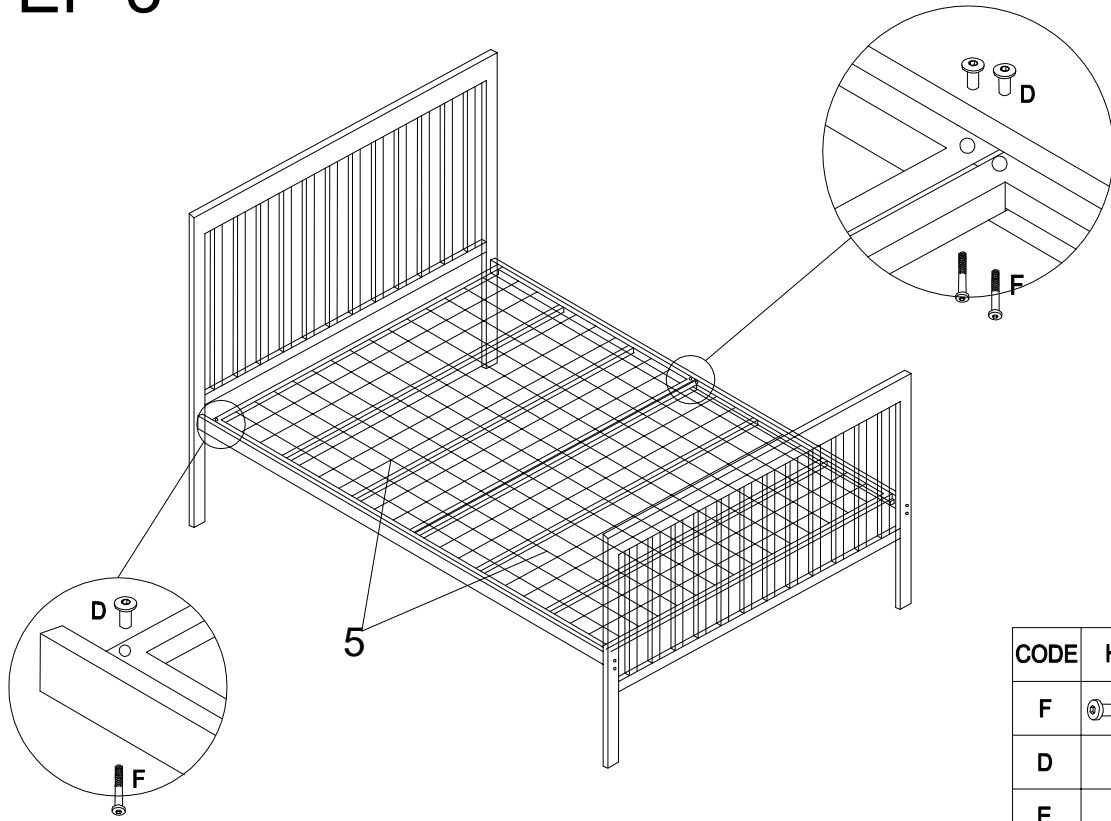

CODE	HARDWARE	QTY
B	 M6X16	4

STEP 3



CODE	HARDWARE	QTY
F	 M6X45	8
D	 M6	8
E		1

STEP 4

