

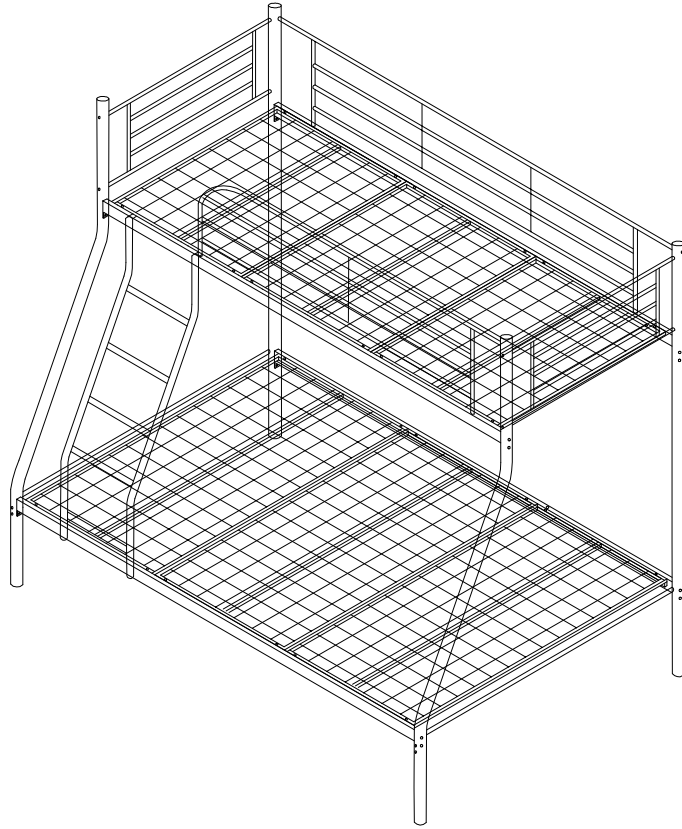











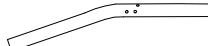
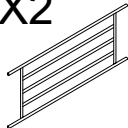

BUNK BED

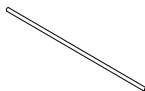
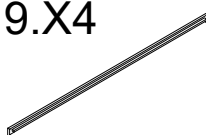
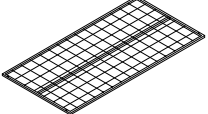
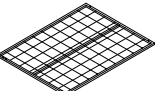
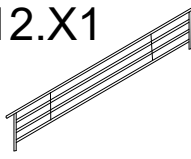
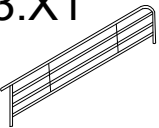
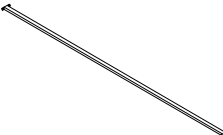
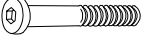
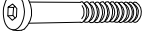
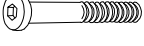
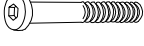
Assembly Instruction

IMPORTANT--READ CAREFULLY AND RETAIN FOR FUTURE REFERENCE

- * This bed is suitable for mattress with size W900xL1900mm. The use of water or flotation mattress is prohibited.
- * All assembly fastenings should always be tighten properly and care should be taken that no fittings are loose.
- * Do not use substitute parts. Contact the manufacturer or dealer for replacement parts. Always follow the manufacturer's instruction. Prohibit more than one person on the upper bed.
- * Use of a night light may provide added safety precaution for a child using the upper bed.
- * **WARNING** : Do not use the bunk bed/high bed if any structural part is broken or missing.
- * **WARNING** : High beds and the upper bed of bunk beds are not suitable for children under six years due to the risk of injury from falls.
- * **WARNING** : Bunk beds and high beds can present a serious risk of injury from strangulation if not used correctly. Never attach or hang items to any part of the bunk bed that are not designed to be used with the bed , for example, but not limited to ropes, strings, cords, hooks, belts and bags.



1.X2 	2.X2 	3.X2 	4.X2 	5.X2 	6.X4 
7.X2 	8.X2 	9.X4 	10.X3 	11.X3 	12.X1 
13.X1 	14.X2 				
A.X20  M8X65mm	B.X7  M6X65mm	C.X27  M6X45mm	D.X8  M6X35mm	E.X20  M6X16mm	F.X20  M8
G.X27  M6	H.X9 	I.X2 	J.X4 	K.X4 	L.X8 

STEP 1

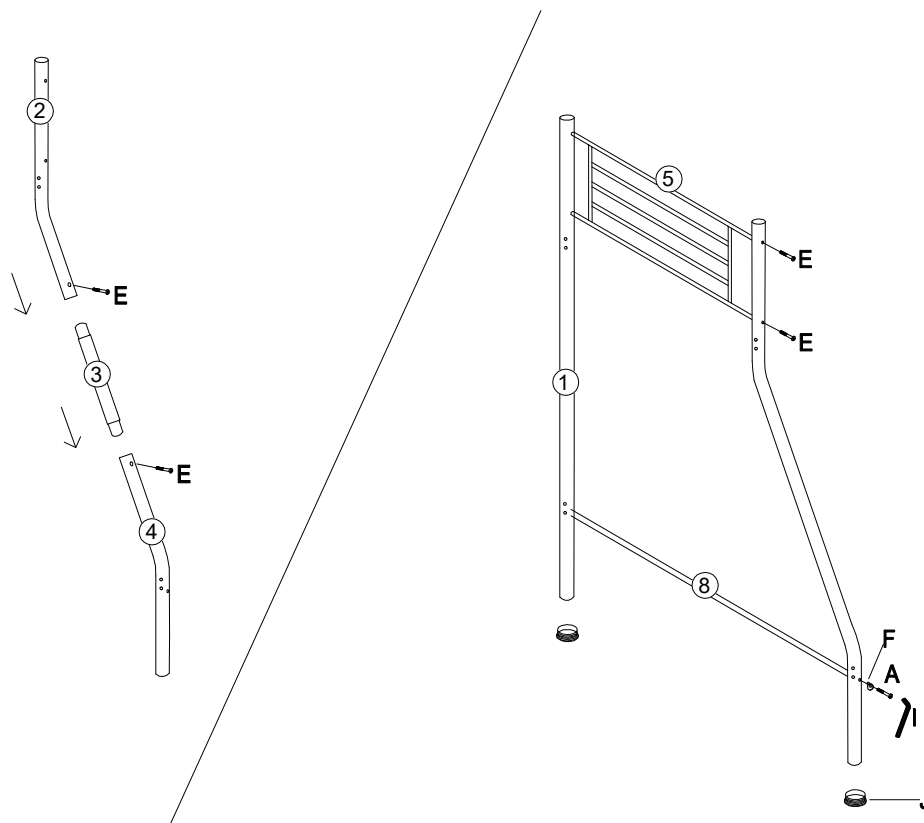

X2

CODE	HARDWARE	QTY
A	M8X65	4
E	M6X16	12
F	M8	4
I		2
J		4

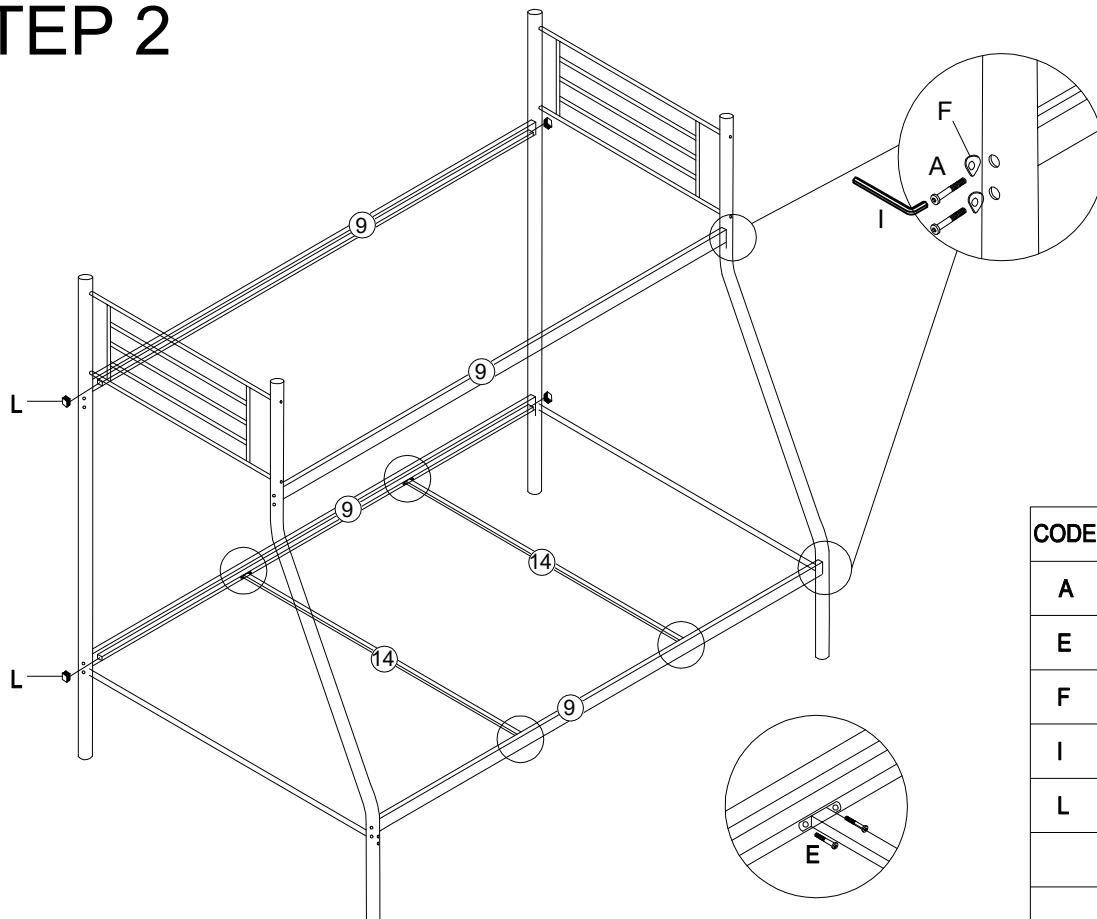

STEP 2



CODE	HARDWARE	QTY
A	M8X65	16
E	M6X16	8
F	M8	16
I		2
L		8

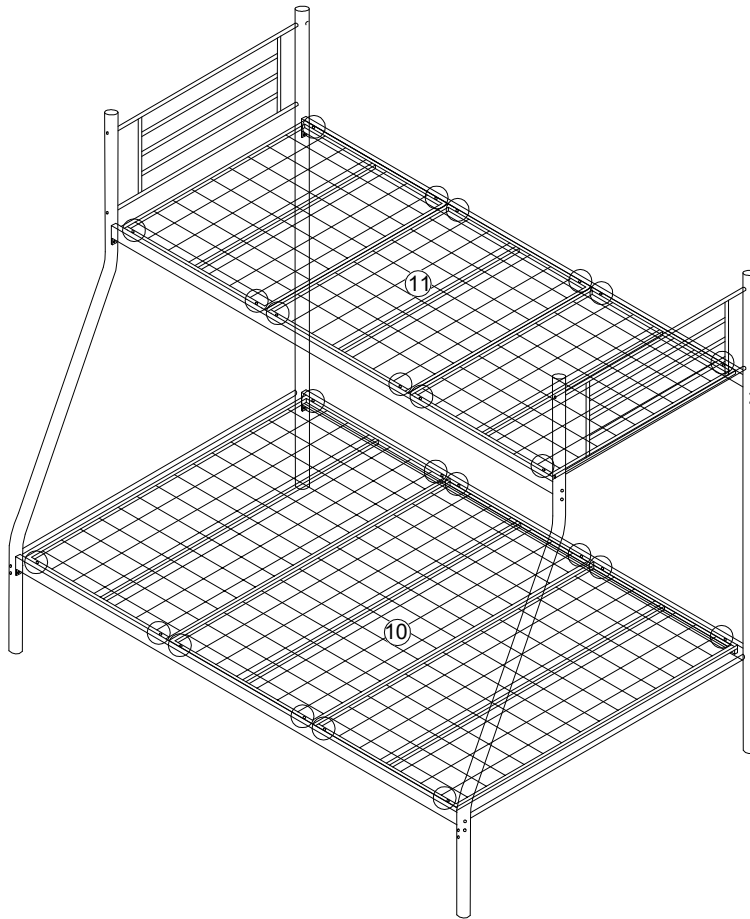
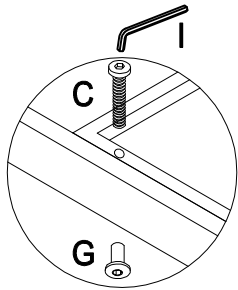

STEP 3



CODE	HARDWARE	QTY
C	 M6X45	24
G	 M6	24
I		1

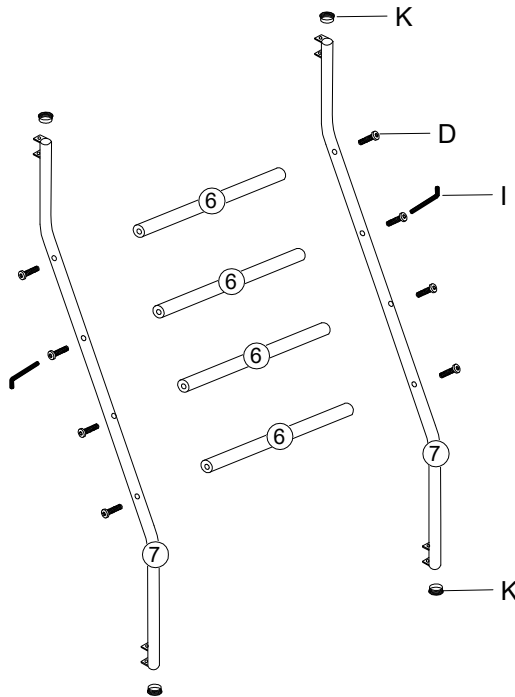



STEP 4

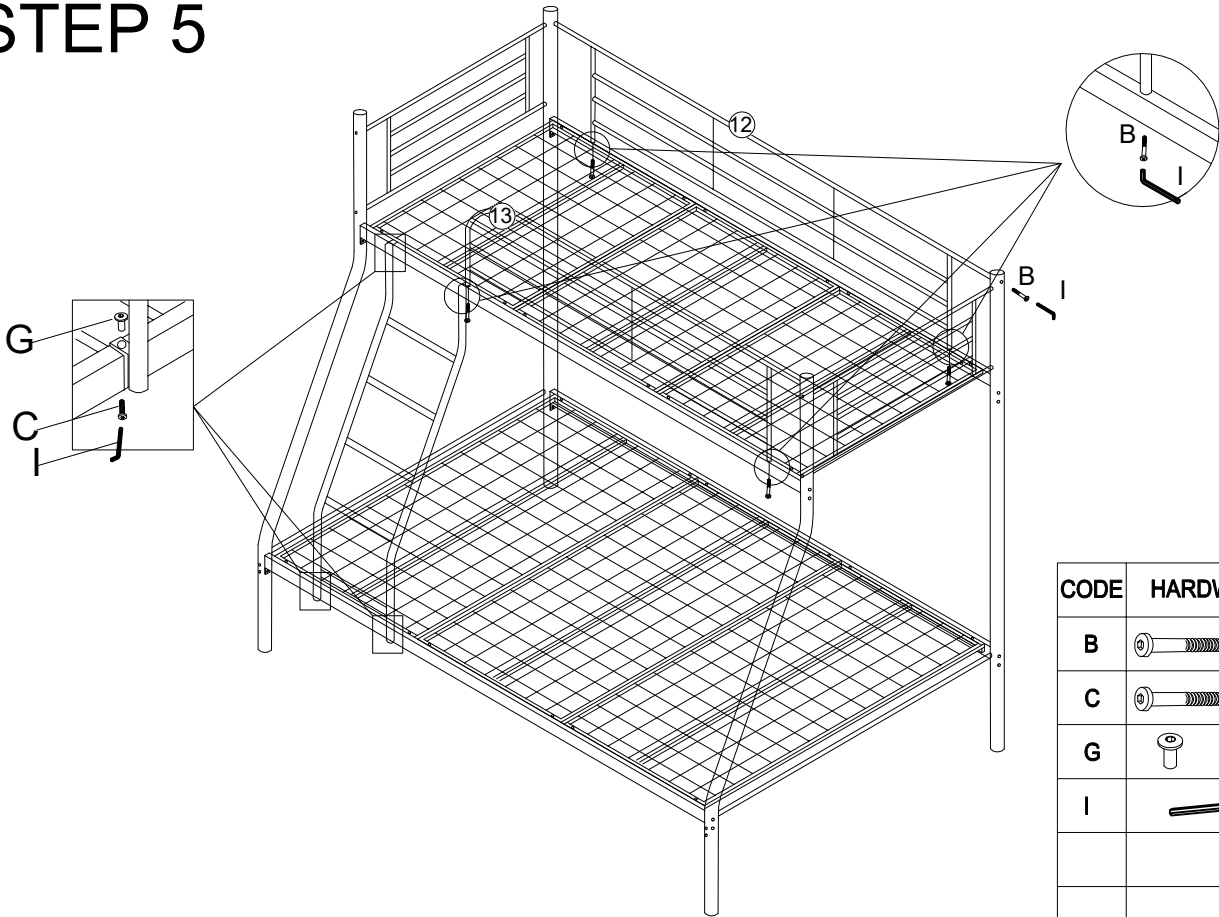

CODE	HARDWARE	QTY
D	 M6X35	8
I		1
K		4

STEP 5



CODE	HARDWARE	QTY
B	 M6X65	7
C	 M6X45	3
G	 M6	3
I		1

STEP 6

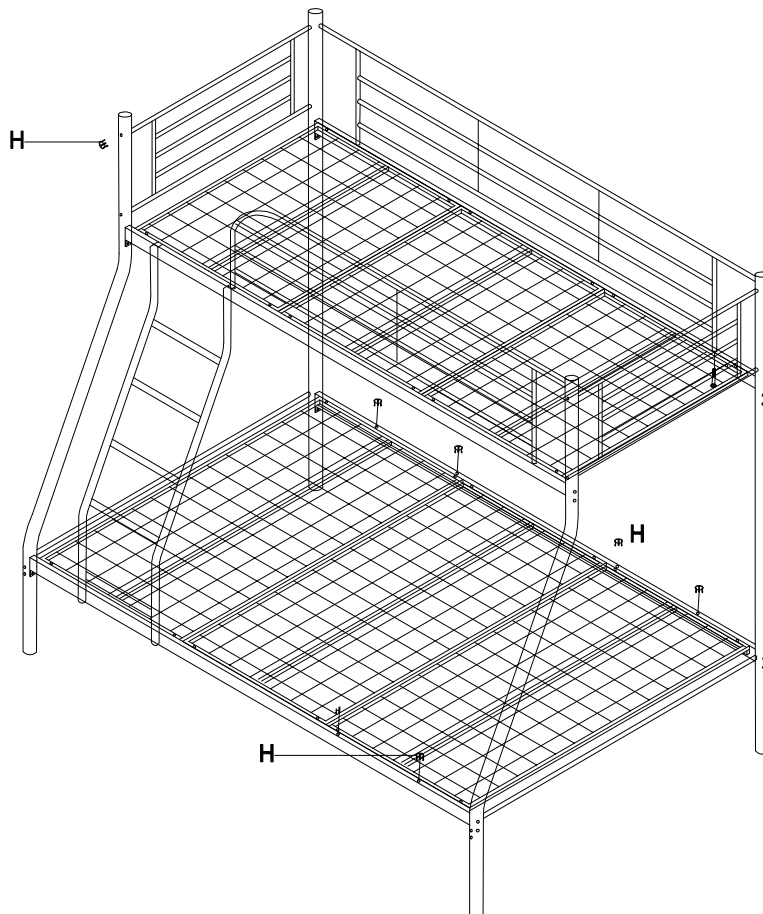

CODE	HARDWARE	QTY
H		11