

Triple Fog Harness

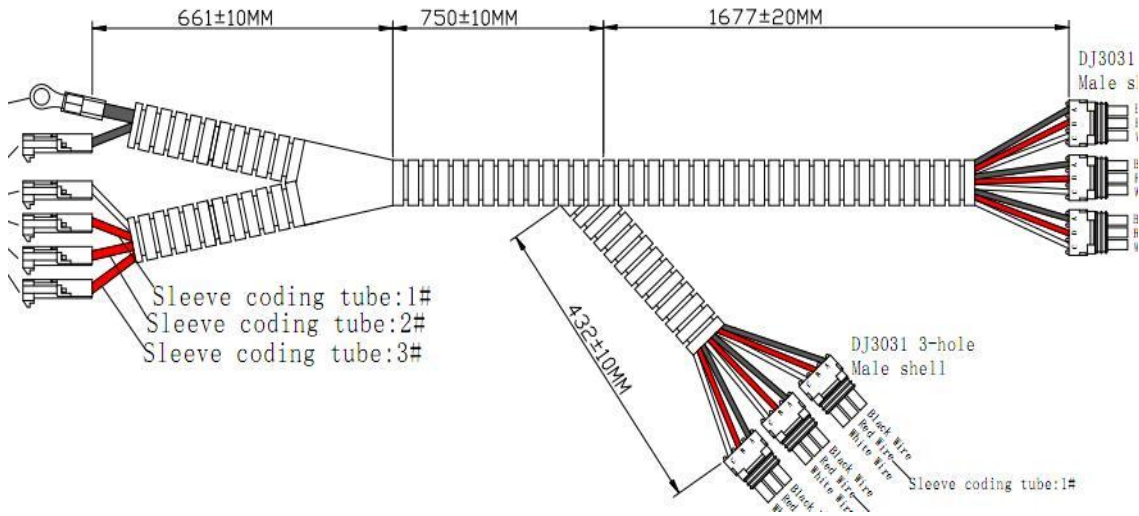

Each one INCLUDES sets of the connectors below. Singles go on the switch wires or trigger wires. The 3 way goes on ANY light that doesn't have a plug on them.

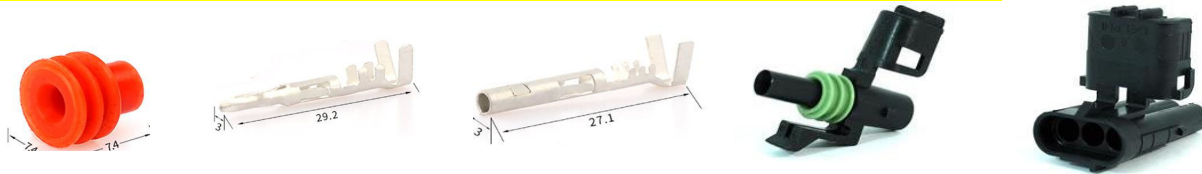

Optional Plug in componets below-

Coupler

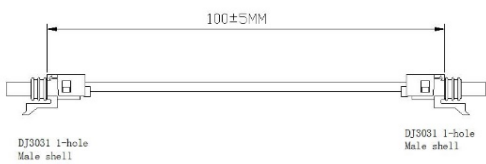

2 way and 3 way splitters/combiners

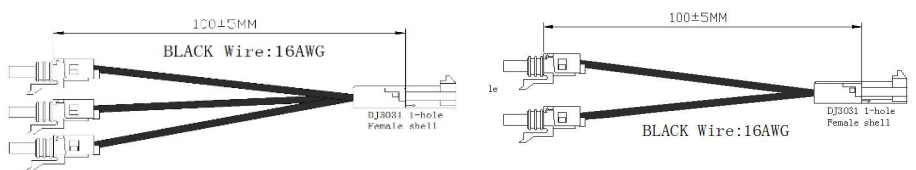

backlight- marker/parking

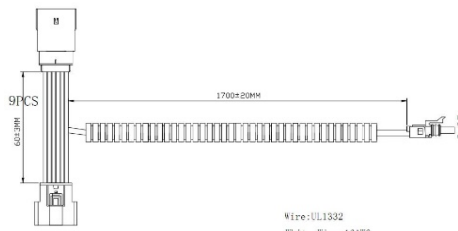

2 light splitter

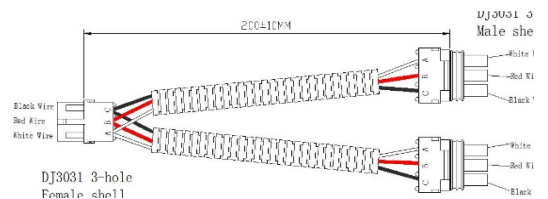

2 way DT adapter



3 Way DT adapter



2 Way WP adapter



Single Pair Fog Harness

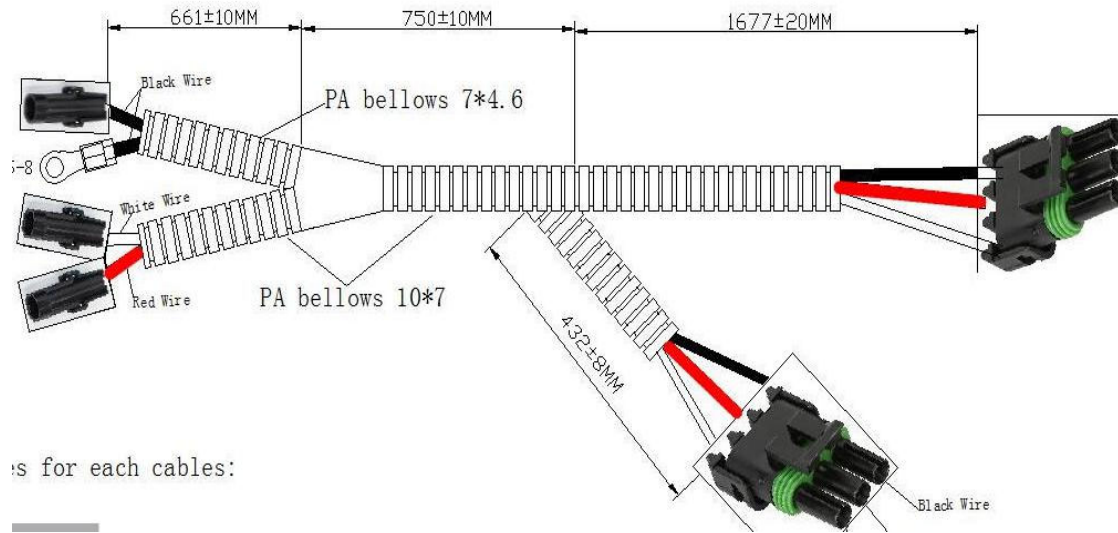

Parts for each cables:

Each one INCLUDES sets of the connectors below. Singles go on the switch wires or trigger wires. The 3 way goes on ANY light that doesn't have a plug on them.



Optional Plug in componets below-

Coupler

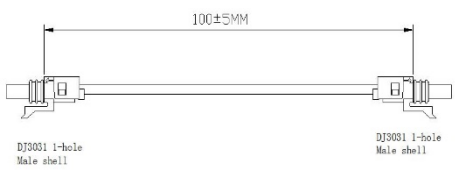

2 way and 3 way splitters/combiners

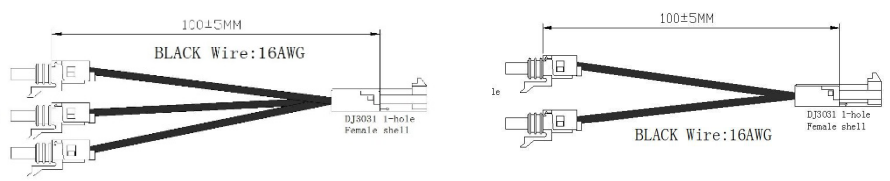

backlight- marker/parking

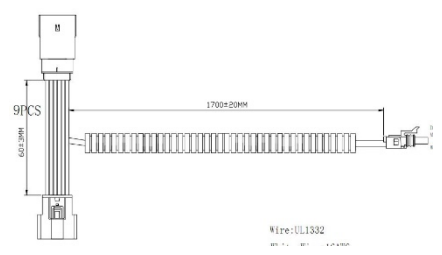

2 light splitter

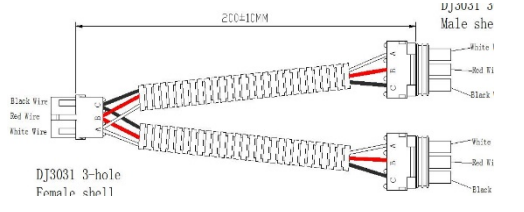

2 way DT adapter



3 Way DT adapter



2 Way WP adapter



Light Bar Harnesses (HD or ST)

Standard is 14 Gauge. Heavy Duty is 10 Gauge

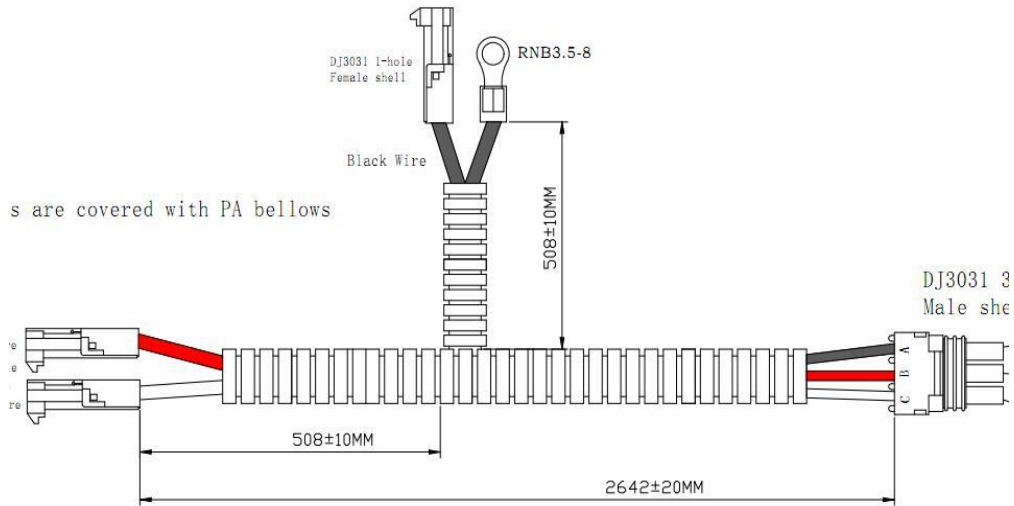

Each one INCLUDES sets of the connectors below. Singles go on the switch wires or trigger wires. The 3 way goes on ANY light that doesn't have a plug on them.

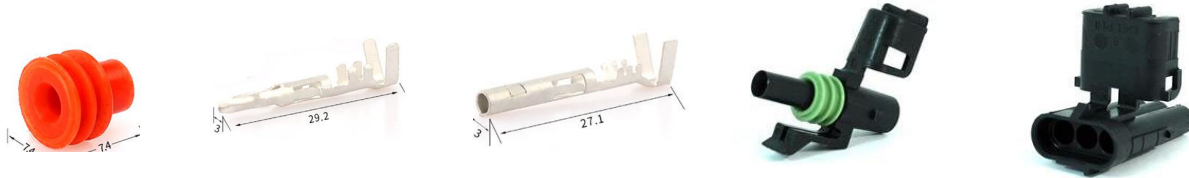

Optional Plug in componets below-

Coupler

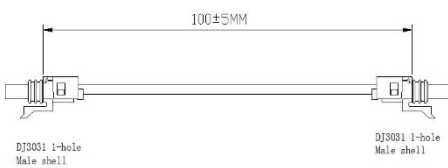

2 way and 3 way splitters/combiners

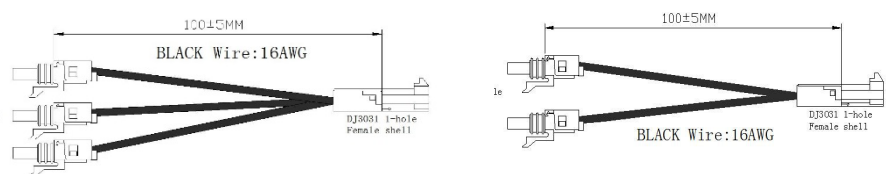

backlight- marker/parking

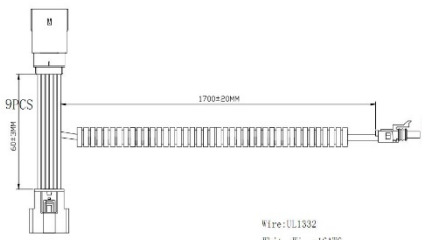

2 light splitter

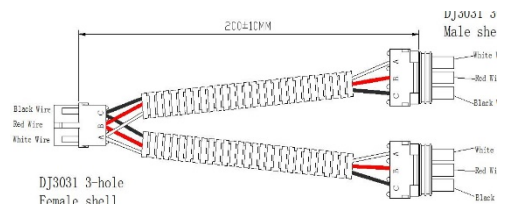

2 way DT adapter



3 Way DT adapter



2 Way WP adapter



Full LENGTH REAR Harness

To Switches

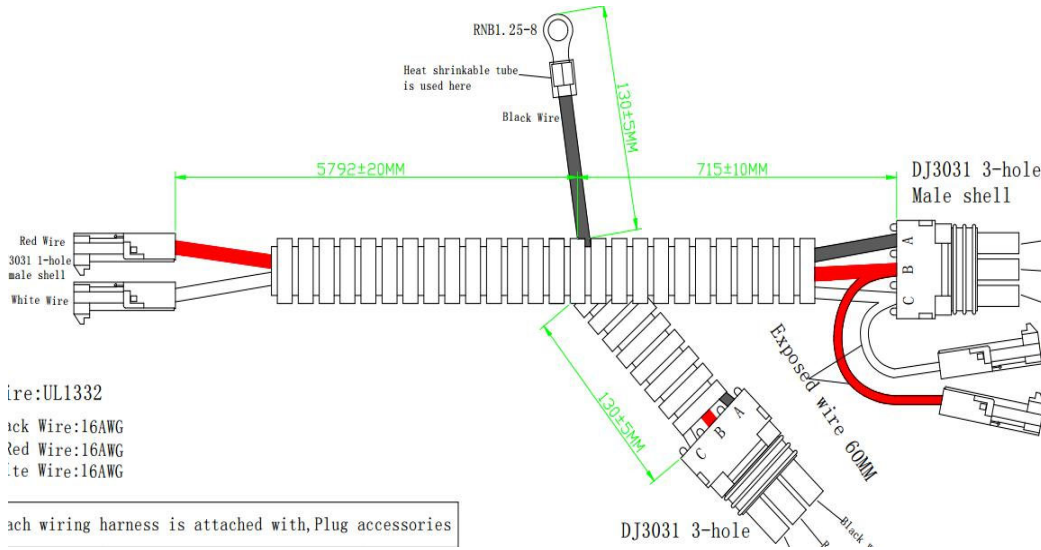

Wire:UL1332
 Black Wire:16AWG
 Red Wire:16AWG
 White Wire:16AWG

Each wiring harness is attached with, Plug accessories

Each one INCLUDES sets of the connectors below. Singles go on the switch wires or trigger wires. The 3 way goes on ANY light that doesn't have a plug on them.



Optional Plug in componets below-

Coupler

2 way and 3 way splitters/combiners

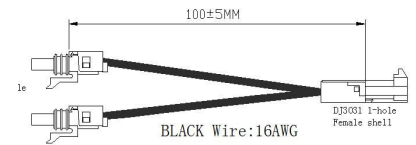
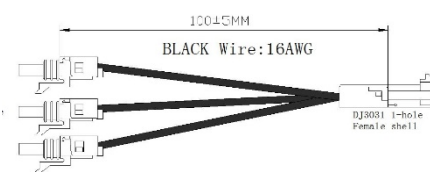
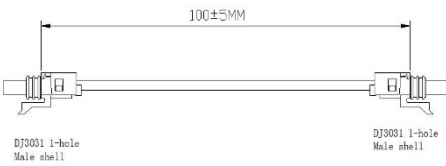

backlight- marker/parking

Tail Light Adapter

2 light splitter

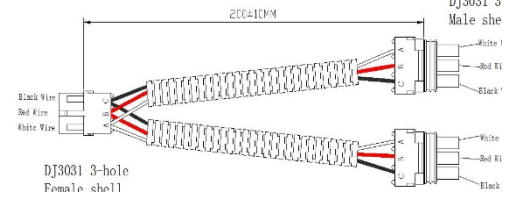
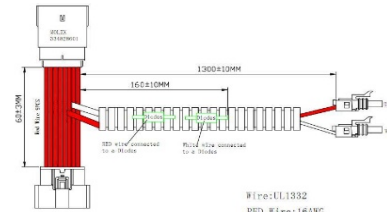
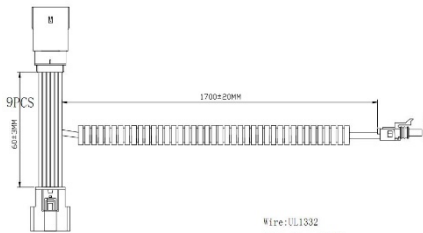

2 way DT adapter

3 Way DT adapter

2 Way WP adapter



SHORT REAR Harness

REAR TRIGGER ONLY

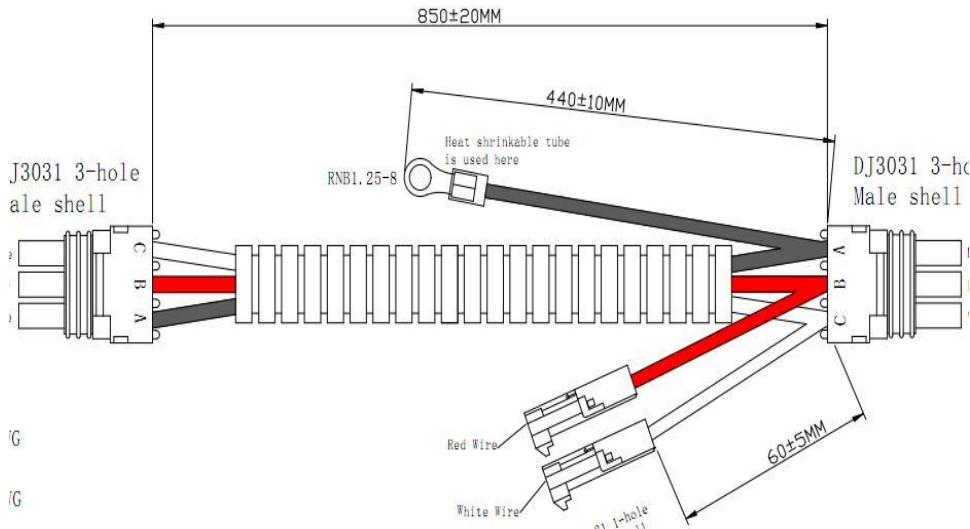

Sockets to left for plug in Tail Light Adapter

Each one INCLUDES sets of the connectors below. Singles go on the switch wires or trigger wires. The 3 way goes on ANY light that doesn't have a plug on them.

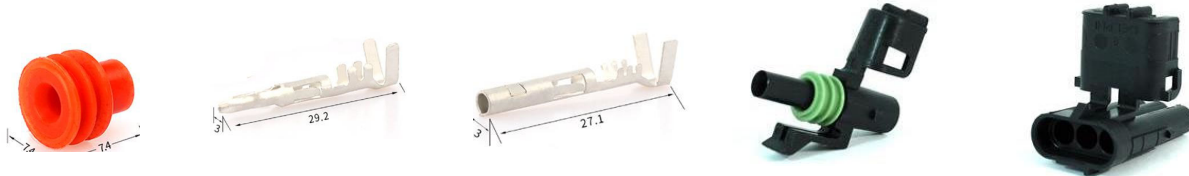

Optional Plug in componets below-

Coupler

2 way and 3 way splitters/combiners

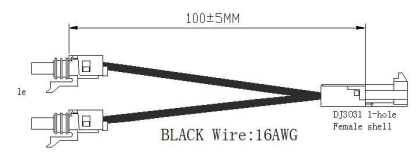
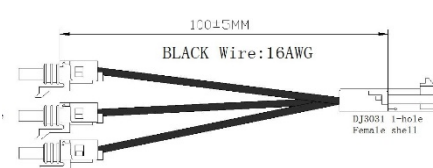
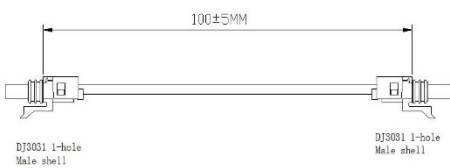

backlight- marker/parking

Tail Light Adapter (Required)

2 light splitter

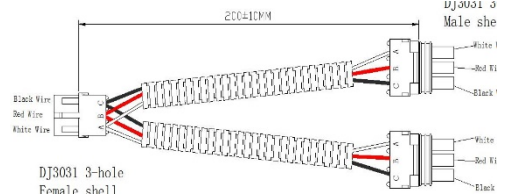
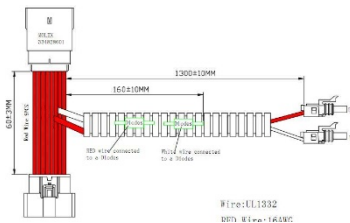
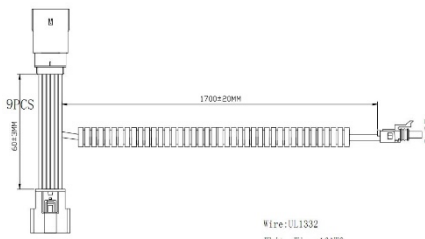

2 way DT adapter

3 Way DT adapter

2 Way WP adapter

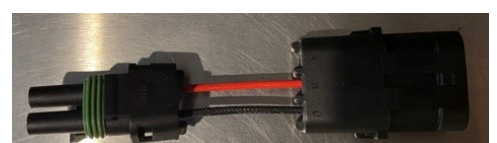

A-Pillar Harness

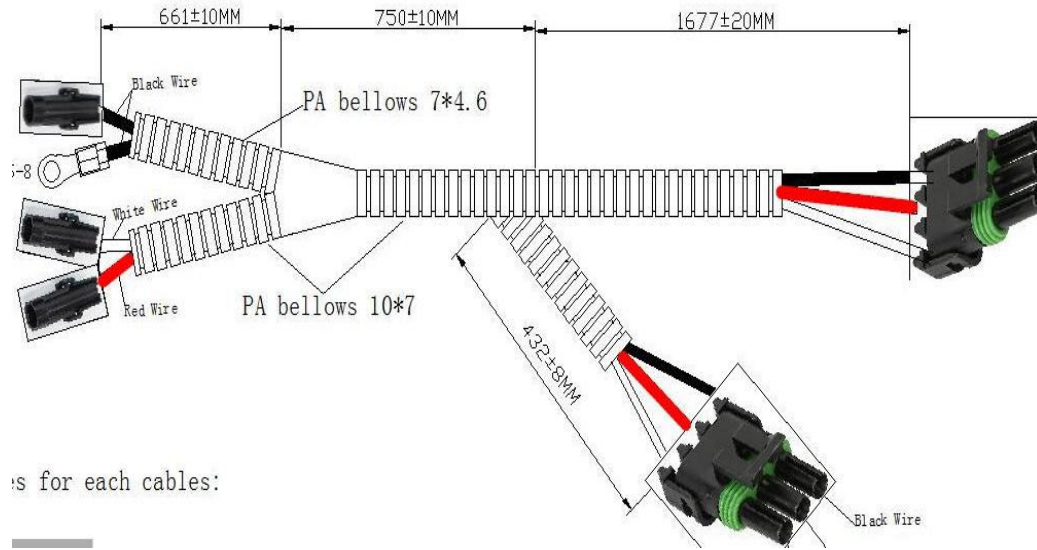

Parts for each cables:

Each one INCLUDES sets of the connectors below. Singles go on the switch wires or trigger wires. The 3 way goes on ANY light that doesn't have a plug on them.

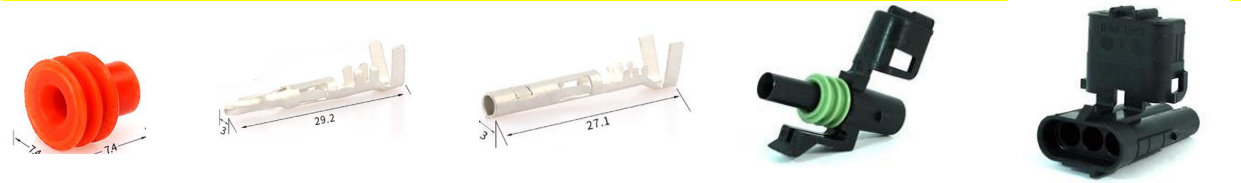

Optional Plug in componets below-

Coupler

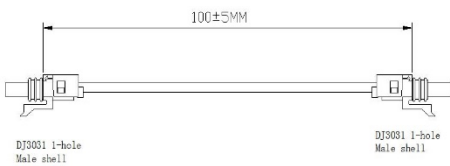

2 way and 3 way splitters/combiners

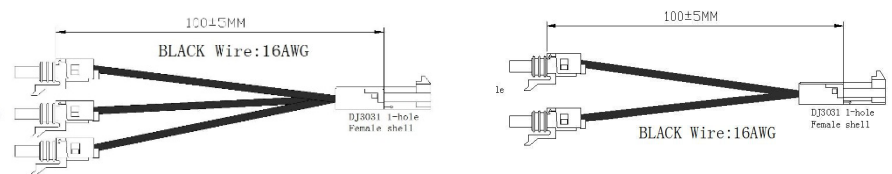

backlight- marker/parking

2 light splitter

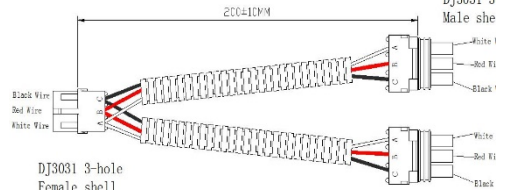
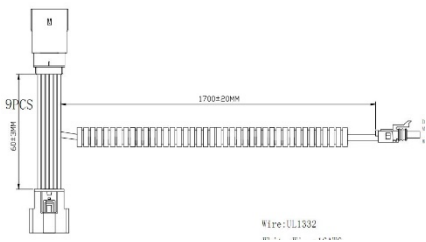

2 way DT adapter

3 Way DT adapter

2 Way WP adapter

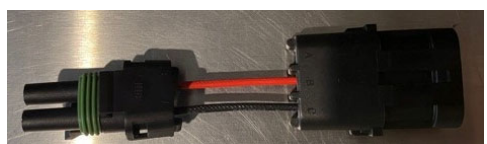

Adapters - Tail Light / Backlight

Tail Light Adapters Current versions (BLISS Tail Lights for F-150/Raptor) and Ranger Version. Halogen F-150 version coming soon.

Plugs DIRECT to tail light and into EITHER the full or short rear harness. Gives Rear Trigger Power AND Marker/Parking Light power to rear harnesses (Includes Diodes so no backfeed)

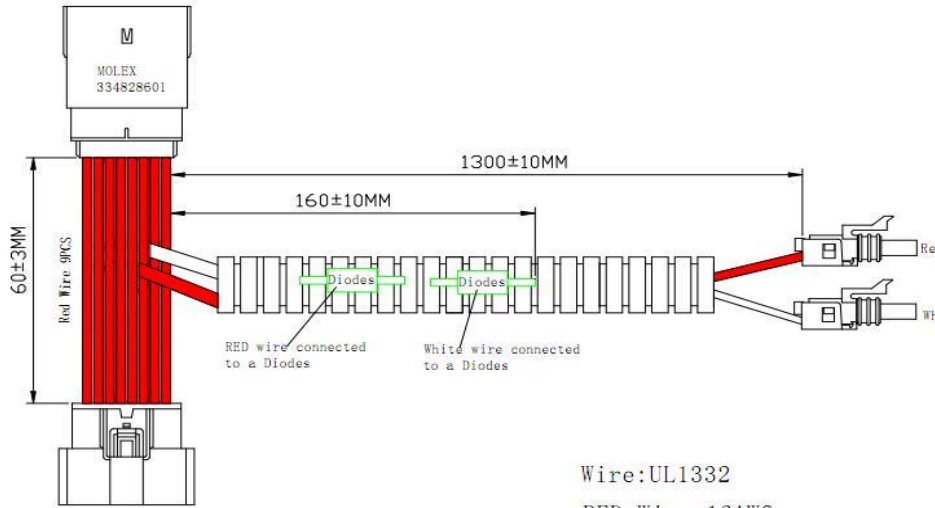

Backlight Adapters Current versions - 17/18 Raptor and 19/20 Raptor

Plugs DIRECT to ANY harness. It can be SPLIT to multiple harnesses with 2 or 3 way splitters. Supplies Marker/Parking light power to backlights.

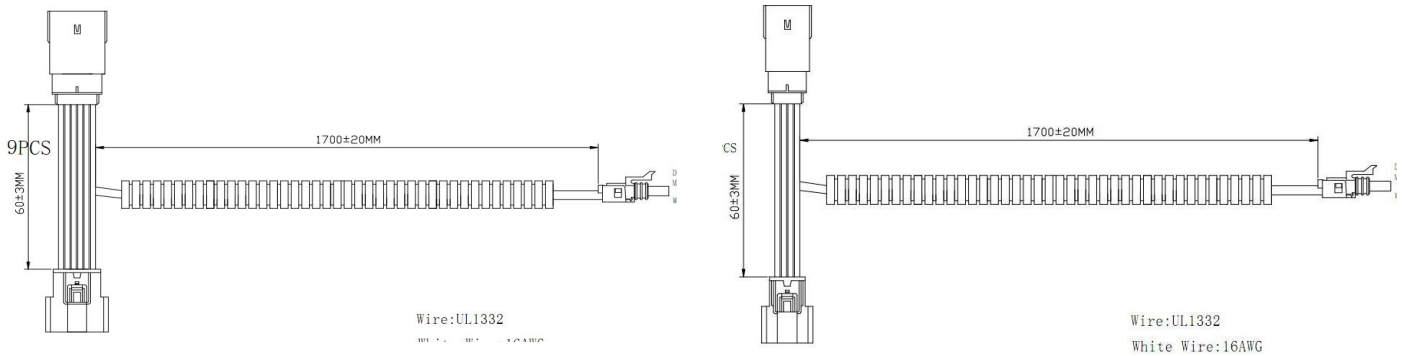

Optional Plug in componets below-

Coupler (Combine FRT & Rear Harnesses)

2 way and 3 way splitters/combiners

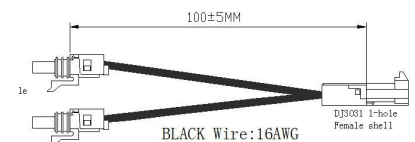
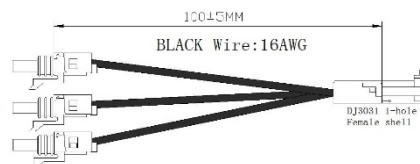
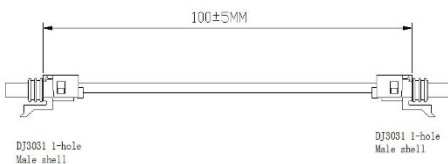

Adapters - Splitters / Couplers

Splitters can be used in MANY ways. Most common would be the following.

- * 3 or 2 way can plug into a triple fog harness and combine 2 or 3 pairs to ONE switch.
- * 3 or 2 ways can plug into TWO Harnesses and combine to ONE switch
- * 3 or 2 ways can plug into backlight adapter and split it to front and rear FULL harness or multiple harnesses, such as light bars, A-Pillar, ETC.
- * Coupler can plug into the WHITE wires of both the FRONT and Rear Harness when a Tail Light Adapter is used. It can then power Backlights on the front harness as well from the rear

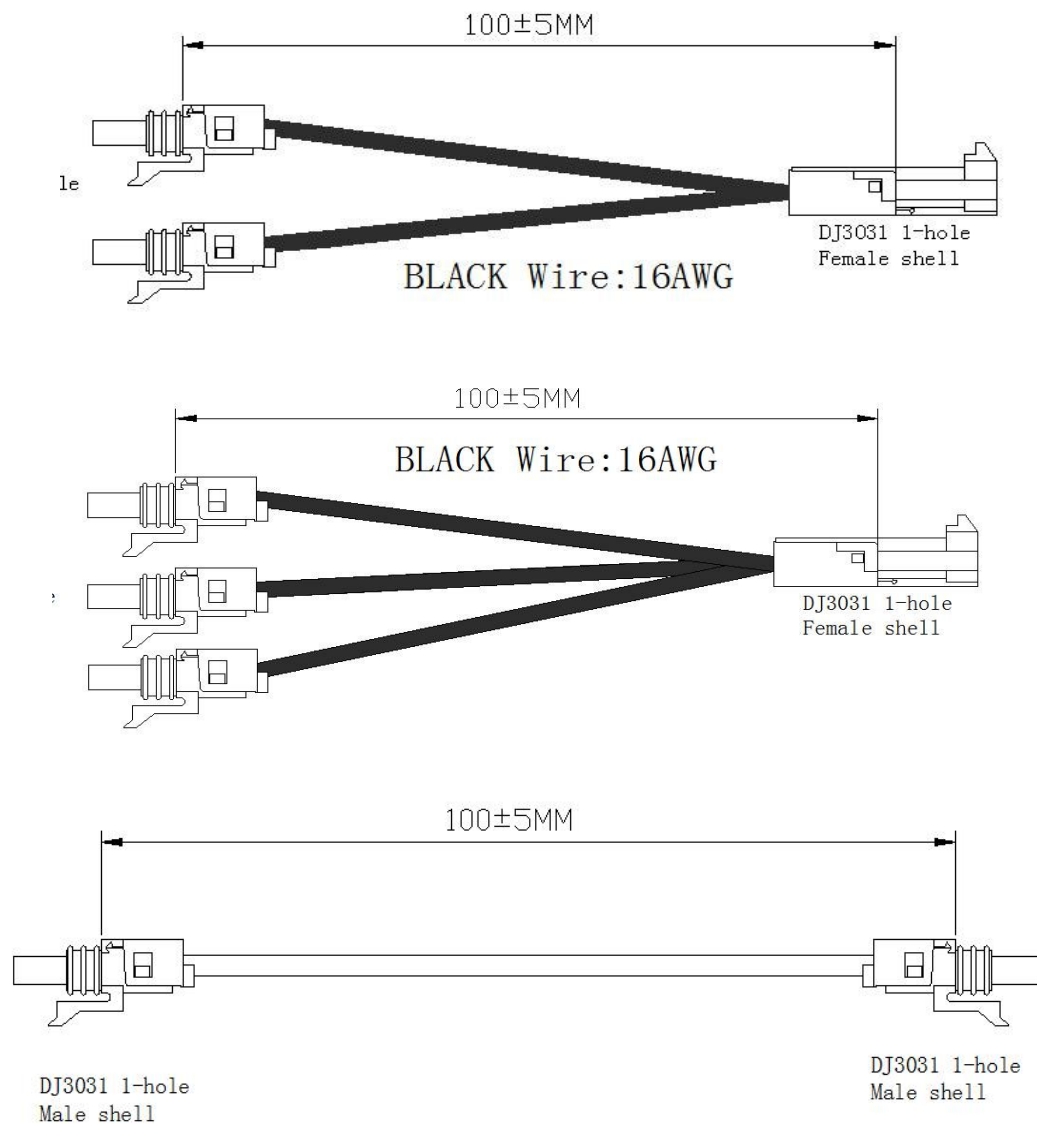

Adapters - Connectors

3 Socket Plug Splitter

* This is used to put 2 lights on one connection. For example. You use a single light bar harness and want to put dual 6" or 10" lights on it.

Another example is, you use a SINGLE PAIR fog harness and put 2 Light Pairs on it. Both would be on the same switch, but you would have 4 lights.

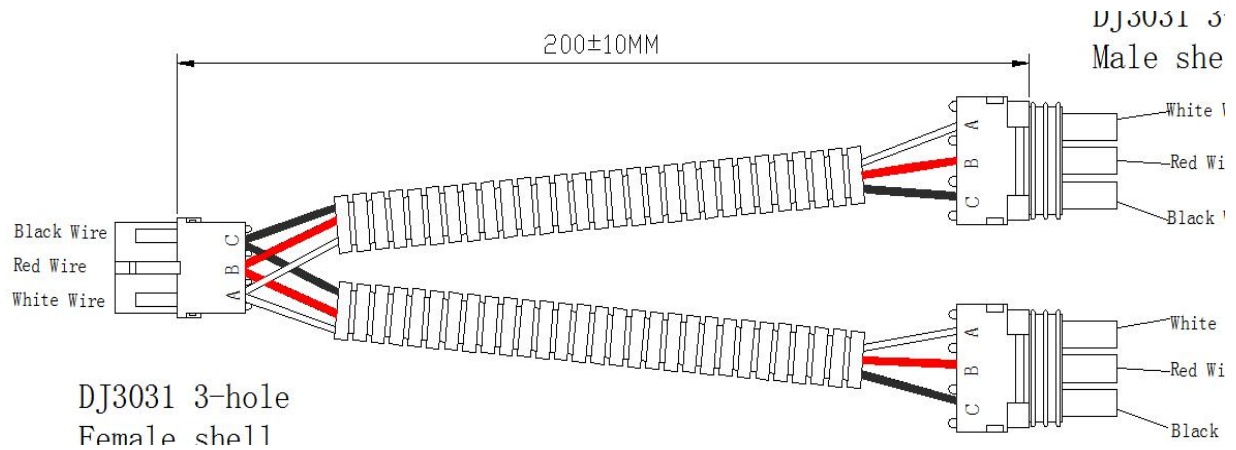

Connector Adapters

These plug DIRECTLY into ANY of these harnesses and MATCH to the 3 way plugs already on them. You can however, if you choose, simply CUT the plugs off the STOCK harnesses you get with lights and put the female 3 way connectors and pins that come with the main harnesses and make your own. This is for simplicity as these are already made.



Adapters - RELAY ADD ON

This relay plugs into ANY of the main harnesses to pull power FROM the battery and can hold up to 30 amps. These solve both the problem of 15 amps max on Raptor/F-250 switches, but also make the universal harnesses work with ANY vehicle make or model.



Specifications:

Name:Triple Pair Fog Harness
number:6FOG-HRN-01
BLACK wire:14AWG for main
wire and 16awg for branch wire
RED wire:16AWG
WHITE wire:16AWG for main
wire and 18awg for branch wire

Name:Single Pair Fog Harness
number:2FOG-HRN-01
BLACK wire:14AWG for main wire
and 16awg for branch wire RED
wire:14AWG for main wire and
16awg for branch wire
WHITE wire:16AWG

Name:STANDARD light bar harness
number:HD-BAR-HRN-01
BLACK wire:14AWG
RED wire:14AWG
WHITE wire:16AWG

Name:Heavy Duty light bar harness
number:HD-BAR-HRN-01
BLACK wire:10AWG
RED wire:10AWG
WHITE wire:16AWG

Specifications: (Continued)

Name:Full Rear Harness
number:FL-REAR-HRN-01
BLACK wire:16AWG
RED wire:16AWG
WHITE wire:16AWG

Name:Short Rear Harness
number:SHRT-REAR-HRN-01
BLACK wire:16AWG
RED wire:16AWG
WHITE wire:18AWG

Name:A-Pillar Harness
number:APIL-HRN-01
BLACK wire:16AWG
RED wire:16AWG
WHITE wire:16AWG

Name: 3 Way WP Splitter
Part Number:WP-3WAY-ADP-01
RED Wires:14AWG
BLACK Wires:14AWG
White Wires:16AWG

Name:Raptor Backlight Power Adapter
19-20 Raptor
number:FRTR-BKLT-HRN-01
WHITE wire:16AWG

Name::Raptor Backlight Power Adapter
17-18 Raptor
number:FRTR-BKLT-HRN-02
WHITE wire:16AWG

Name:Ford Rev Power Harness (BLISS)
15-20 F-150 & Raptor with LED Tail Lights
number:FD-REV-HRN-01
RED wire:16AWG
WHITE wire:16AWG

Name:Ford Rev Power Harness (RANGER)
19-21 Ford Ranger
number:FD-REV-HRN-03
RED wire:16AWG
WHITE wire:16AWG

Name: 2 Way Splitter Adapter
Part Number:2WAY-SPLT-01
BLACK Wires:16AWG

Name: 3 Way Splitter Adapter
Part Number:3WAY-SPLT-01
BLACK Wires:16AWG

Name: Coupler Adapter
Part Number:CPLR-ADP-01
White Wires:16AWG

Name:Relay add on harness
number:RLY-ADPT-HRN-01
BLACK wire:10AWG
RED wire:10AWG
Blue wire:18AWG

Specifications: (Continued 2)

Name: WP 2-Way Adapter
Part Number-WP-2WAY-ADP-01
RED Wires:16AWG
BLACK Wires:16AWG

Name: DT 2-Way Adapter
Part Number:DT-2WAY-ADP-01
RED Wires:16AWG
BLACK Wires:16AWG

Name: DT 3-Way Adapter
Part Number:DT-3WAY-ADP-01
RED Wires:16AWG
BLACK Wires:16AWG
White Wires:16AWG

Name: Stock Fog Adapter
Part Number:STK-FG1-ADP-01
RED Wires:16AWG
BLACK Wires:16AWG
White Wires:16AWG