

Build Your Own Cushion

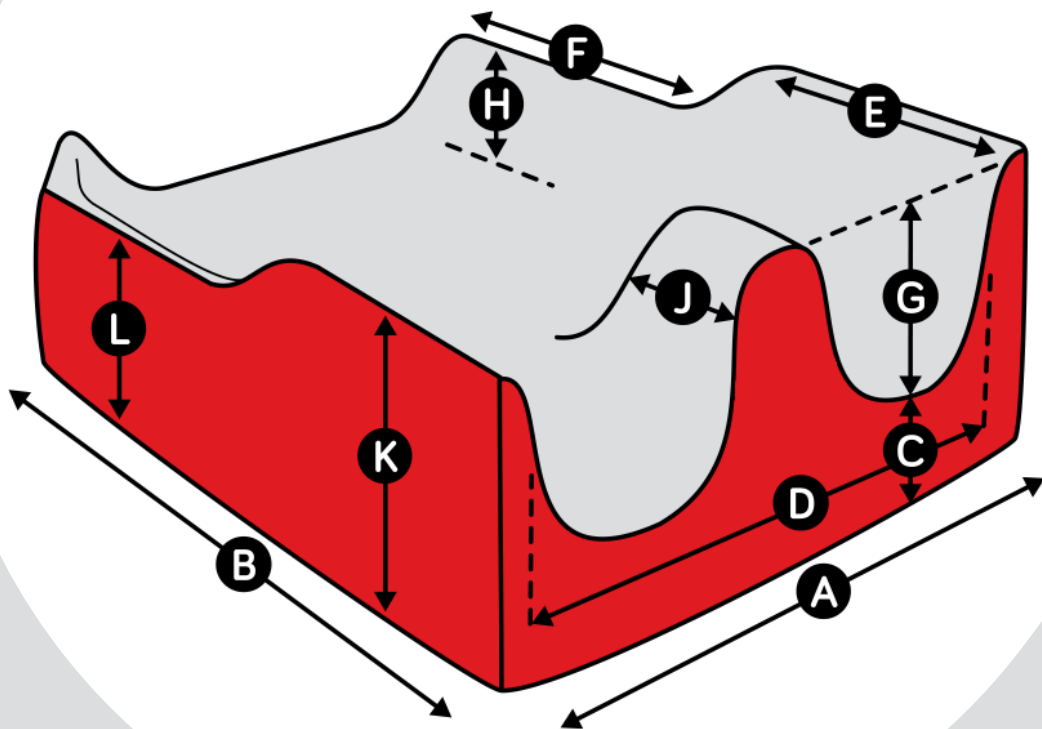

spex

CUSHION

SCRIPTING AND ORDERING GUIDE

Contents

Client Details	2
Specify Cushion Size	3
Select Air Mesh Colour	3
Overlay	4
Medial Thigh Support	5
Leg Length Discrepancy	6
Thigh Angle	7
Contracture Cut-back	8
Create Thigh Laterals	9
Hip Belt Slot	10
Pelvic Ischial Area	11
Base Style	11
Outer Cover Material	12
Optional Accessories	13
Contouring Chart	14

Client Details

Client Details:

Client Name:		Carer Name:	
Date of Birth:		Carer Contact Number:	
Weight:		Assessment Date:	
Salesperson Name:		Distributor Name:	
Salesperson Contact Number:		Distributor Contact Number:	

Seating Measurements:

	LEFT	RIGHT		LEFT	RIGHT
A Lower Leg Length			F Chest Depth		
B Thigh Length			G Hip Width		
C Ischial Well Length			H Chest Width		
D Shoulder Height			I Shoulder Width		
E Axila Height			J Elbow Height		

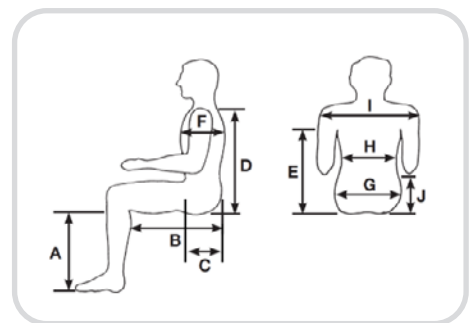

Notes:

Specify Cushion Size

10 - 17" WIDE (1109-0017-000)

17 - 26" WIDE (1109-0026-000)

WIDTH
_____ inches

LENGTH
_____ inches

Base Style

FLAT
1111-0210-000

HEIGHT (C)
_____mm

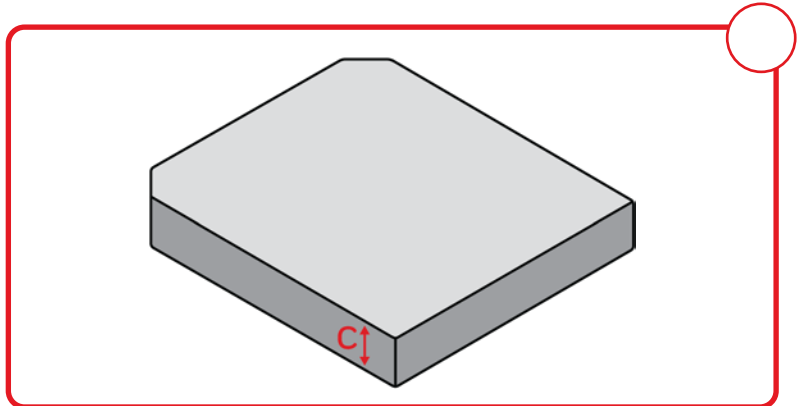

ANTI-THRUST
1111-0220-000

LENGTH (A) _____cm

FRONT HEIGHT (B) _____cm

REAR HEIGHT (C) _____mm

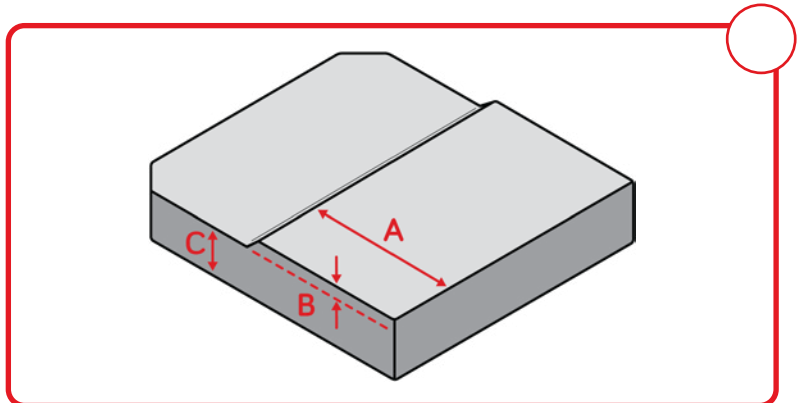

CUSTOMISATIONS

A large rectangular area filled with a red grid, intended for users to specify customisations for their cushion.

Overlay

PRESSURE RELIEVING & MEMORY FOAM



Default combination if no overlay is specified.

½" GEL FOAM (N/A for SuperHigh contouring)

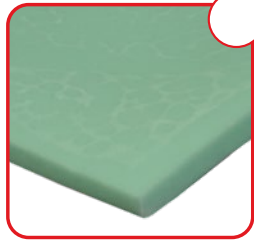

1111-0392-000

Note: the soft upper layer will be replaced with this overlay

1" SOFT GEL FOAM



1111-0395-000

Note: the soft upper layer will be replaced with this overlay

SUPRACOR®

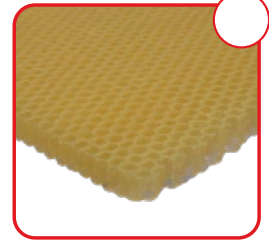

1111-0431-000

Installed into special Supracor® Overlay supplied inside special envelope outer cover

PRESSURE RELIEVING OVERLAY



1111-0391-000

Additional layer of pressure-relieving overlay.

15MM MEMORY FOAM OVERLAY



1111-0393-000

Additional layer of 15mm memory foam.

30MM MEMORY FOAM OVERLAY



1111-0394-000

Additional layer of 30mm memory foam.

DIAGRAM

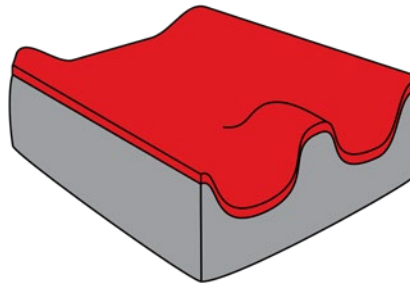

CUSTOMISATIONS

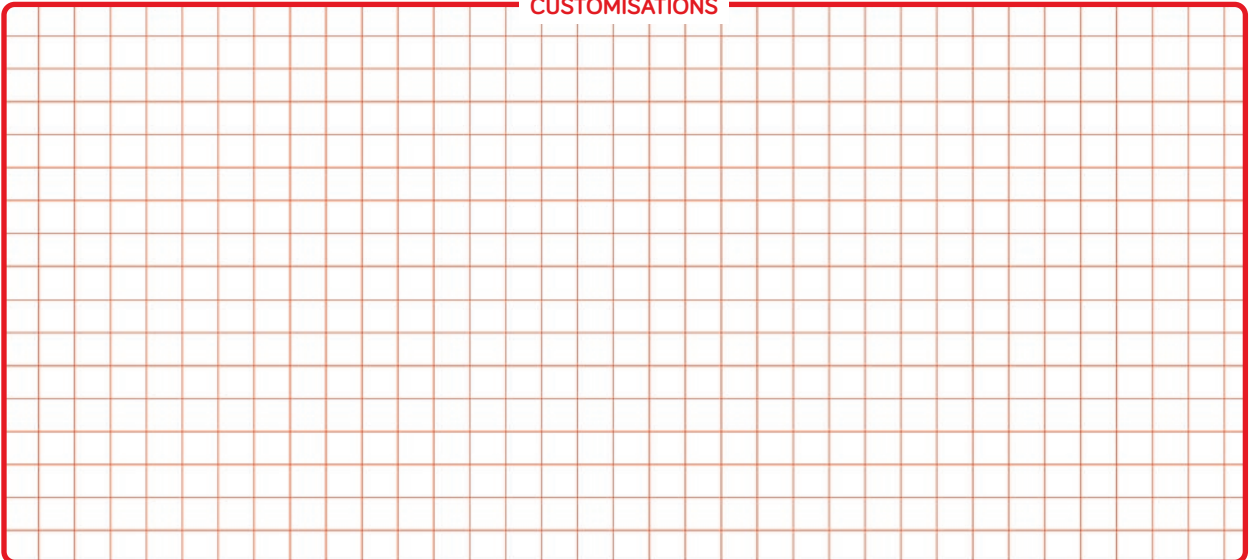

Medial Thigh Support (1111-0294-000)

DEPTH (L) _____ mm

HEIGHT (M)* _____ mm

*Required

FRONT WIDTH (N) _____ mm

EXTENSION (E) _____ mm

REAR WIDTH (K) _____ mm

LATERAL THIGH SUPPORT EXTENSIONS (F) _____ mm

NORMAL MEDIAL THIGH SUPPORT HEIGHTS

STANDARD CONTOUR	30mm	
HIGH CONTOUR	50mm	
SUPERHIGH CONTOUR	Cushions < 14"	80mm
SUPERHIGH CONTOUR	Cushions > 14"	100mm

DIAGRAM

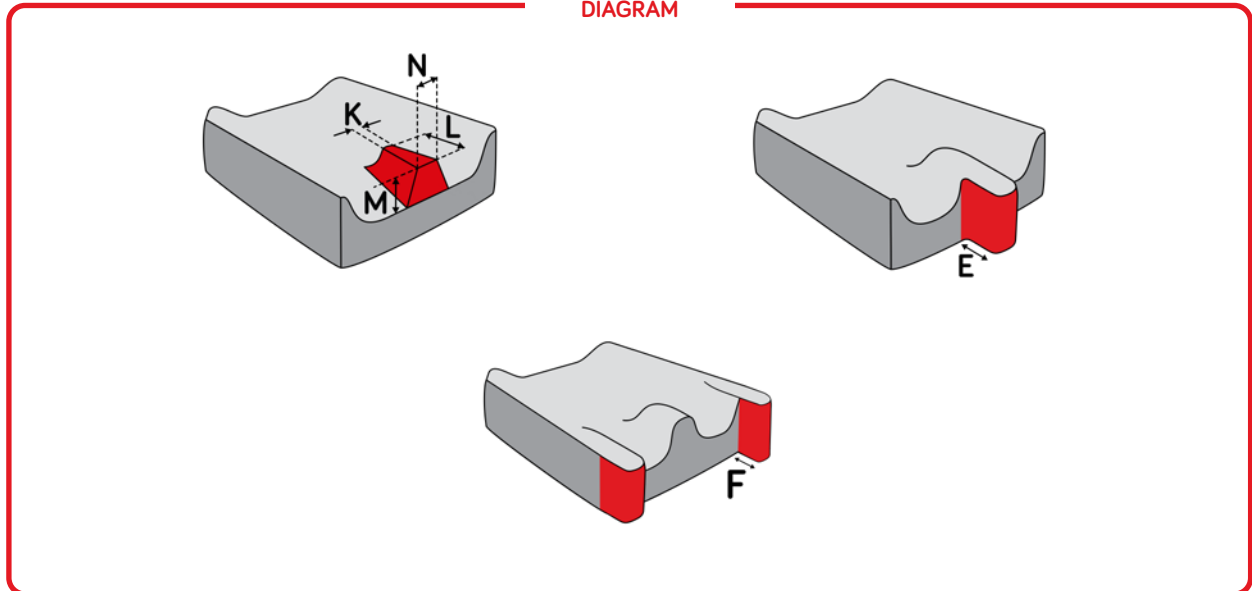

Note: If N, K or L are not specified, normal sizes proportionate to chosen height will be produced

CUSTOMISATIONS

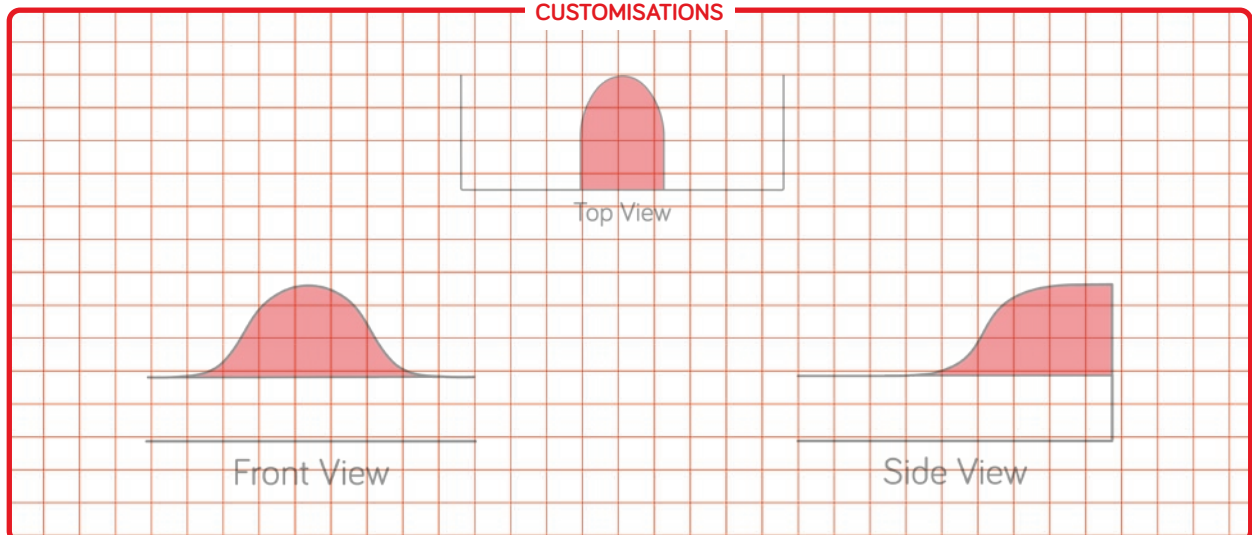

Leg Length Discrepancy 111-0292-000

LEFT _____ mm	RIGHT _____ mm
-------------------------	--------------------------

Note: Can only select left OR right.

DIAGRAM

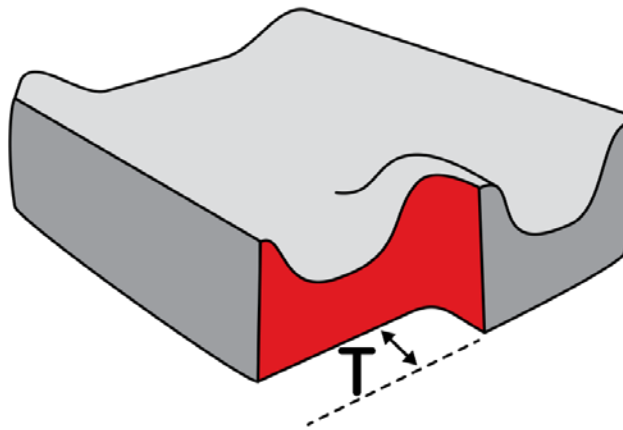

CUSTOMISATIONS

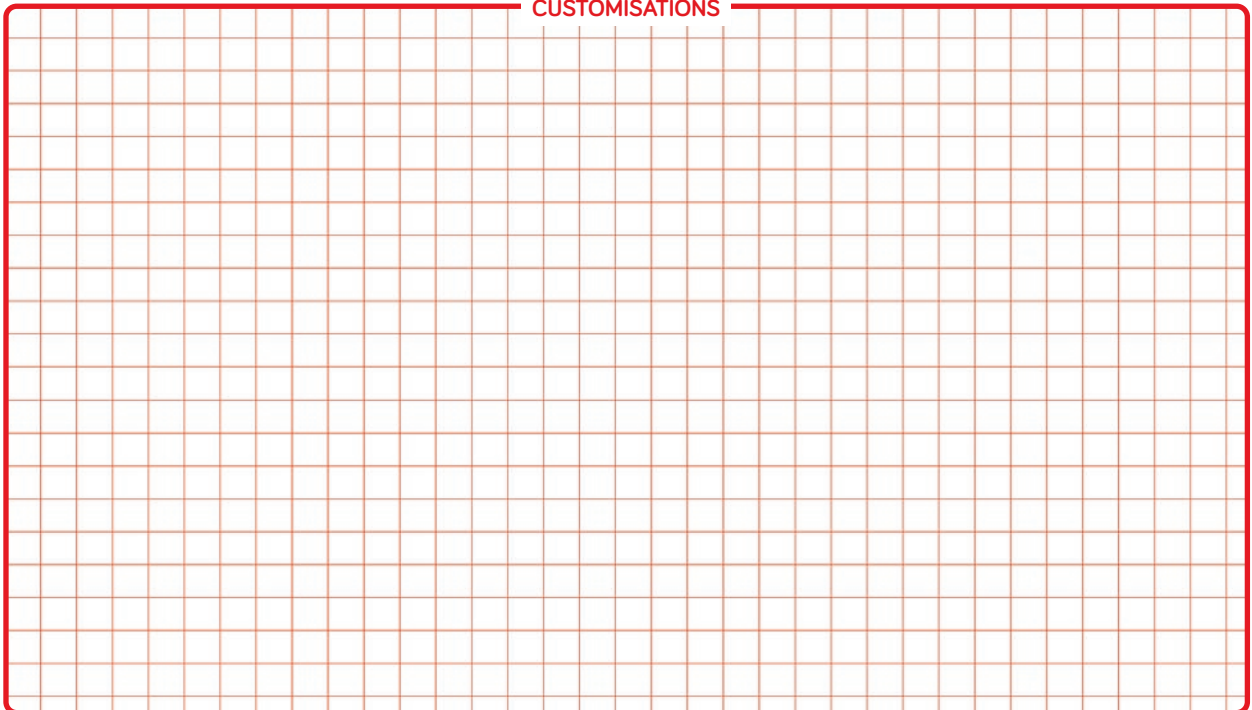

Thigh Angle 1111-0285-000

Note: Depending on the angles required, the cushion may need to be made higher or lower to ensure correct padding under the legs.

LEFT	
<input type="radio"/> UP <input type="radio"/> DOWN	_____ mm or _____degrees
RIGHT	
<input type="radio"/> UP <input type="radio"/> DOWN	_____ mm or _____degrees

Note: Cannot apply thigh elevation and drop to the same leg.

DIAGRAM

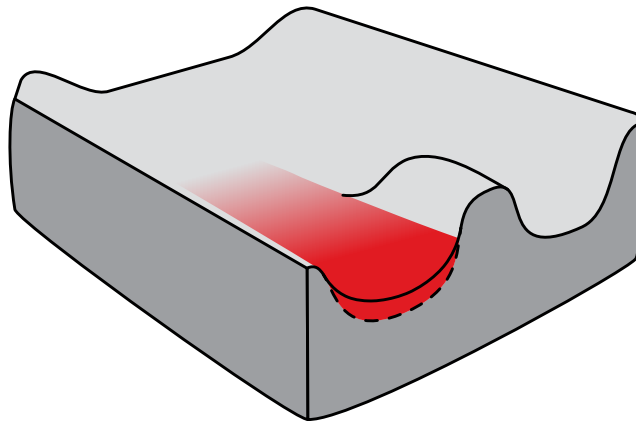

CUSTOMISATIONS

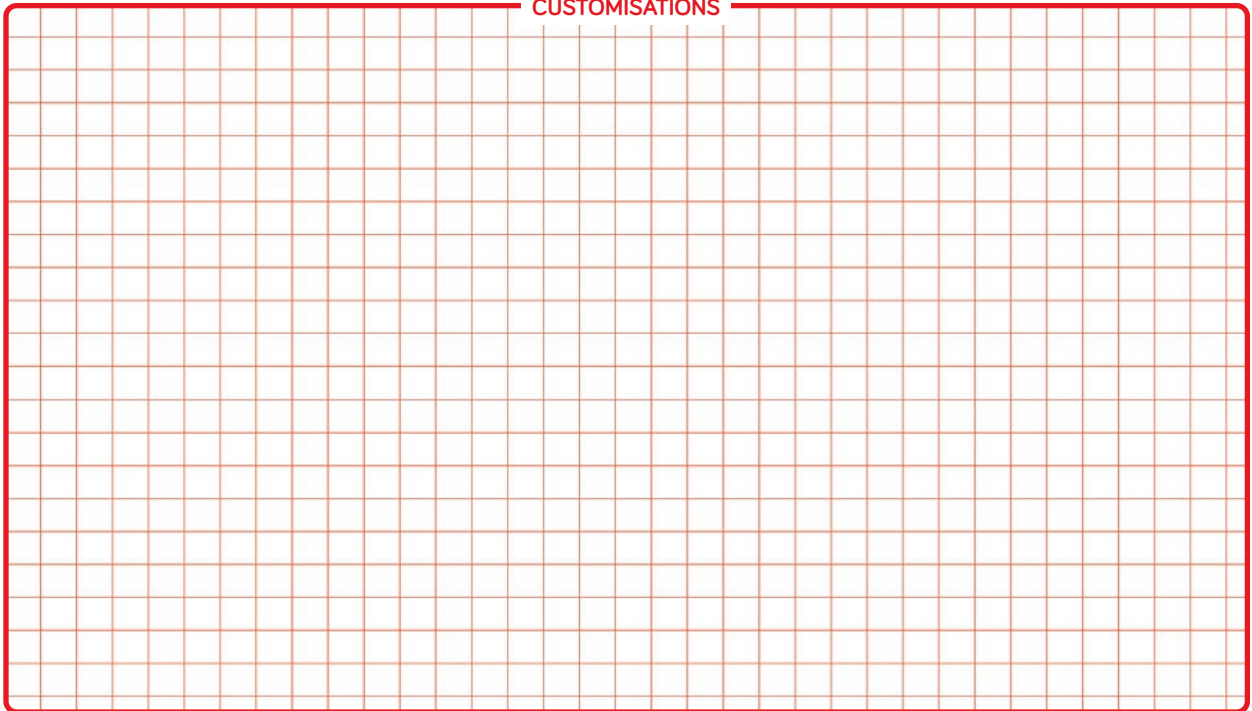

Contracture Cut-back 1111-0281-000

LEFT
_____ mm or _____degrees cutback

RIGHT
_____ mm or _____degrees cutback

Note: If adding to leg length discrepancy, start measurement from 'new front'

DIAGRAM

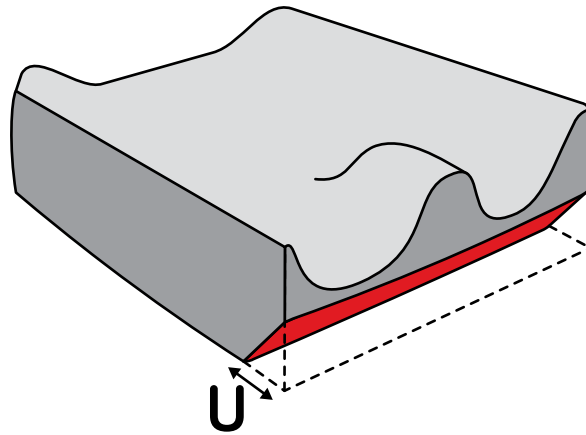

CUSTOMISATIONS

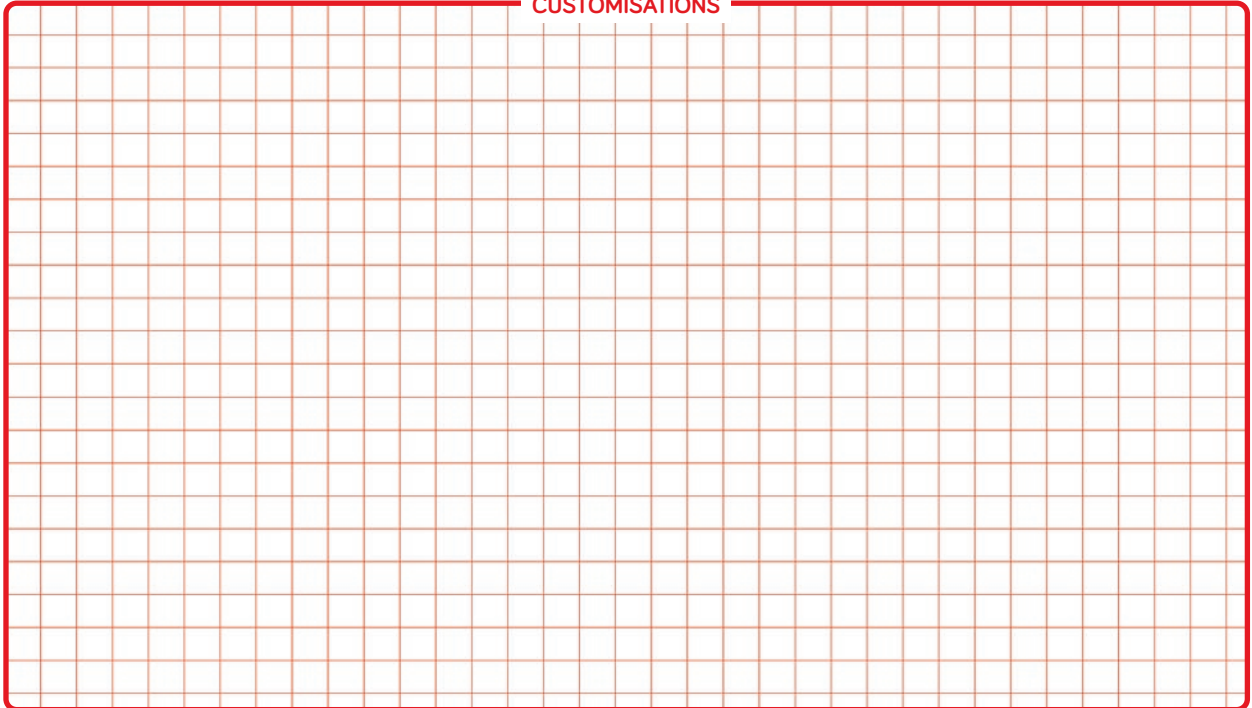

Create Thigh Laterals

USER'S RIGHT SIDE

1111-0261-000

REAR CONTOURING

HEIGHT

XX = ____ cm

LENGTH

XX = ____ cm

THICKNESS

XX = ____ cm

FRONT CONTOURING

HEIGHT

XX = ____ cm

LENGTH

XX = ____ cm

THICKNESS

XX = ____ cm

DIAGRAM

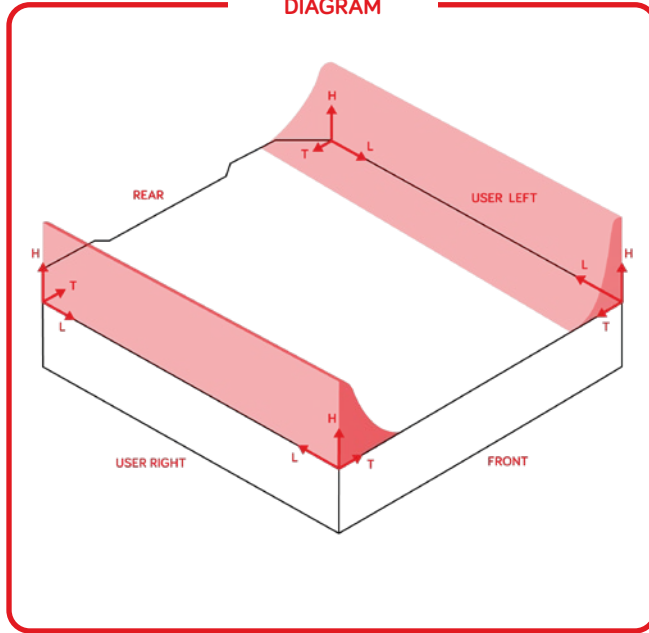

USER'S LEFT SIDE

1111-0262-000

REAR CONTOURING

HEIGHT

XX = ____ cm

LENGTH

XX = ____ cm

THICKNESS

XX = ____ cm

FRONT CONTOURING

HEIGHT

XX = ____ cm

LENGTH

XX = ____ cm

THICKNESS

XX = ____ cm

NORMAL THIGH LATERAL SUPPORT HEIGHTS

STANDARD CONTOUR	30mm
HIGH CONTOUR	50mm
SUPERHIGH CONTOUR	Cushions < 14" 80mm
SUPERHIGH CONTOUR	Cushions > 14" 100mm

CUSTOMISATIONS

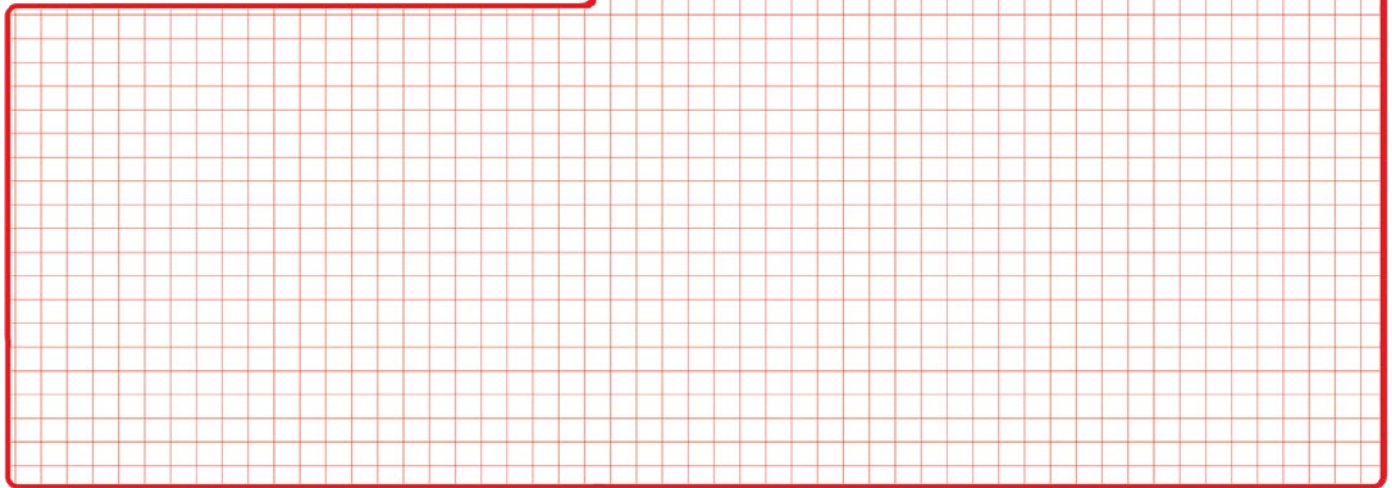

EXAMPLES

WINDSWEPT CONTOURS

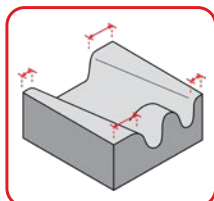

ABDUCTION CONTOURING

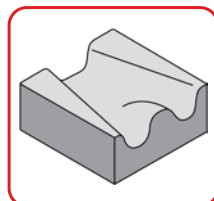

FRONT OR REAR CONTOURING ONLY

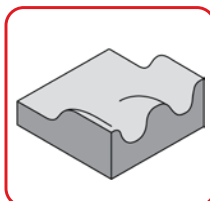

ASYMMETRIC LATERAL CONTOURS

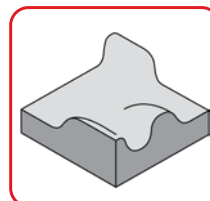

LATERAL THIGH SUPPORT EXTENSIONS

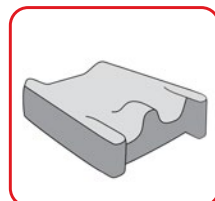

Hip-Belt Slot 1111-0296-000

SIDE OF CUSHION
Ⓐ | Ⓑ

CUSTOM GAP (G)
_____mm

CUSTOM LENGTH (L)
_____mm

SIDE OF CUSHION
Ⓐ | Ⓑ

CUSTOM GAP (G)
_____mm

CUSTOM LENGTH (L)
_____mm

DIAGRAM

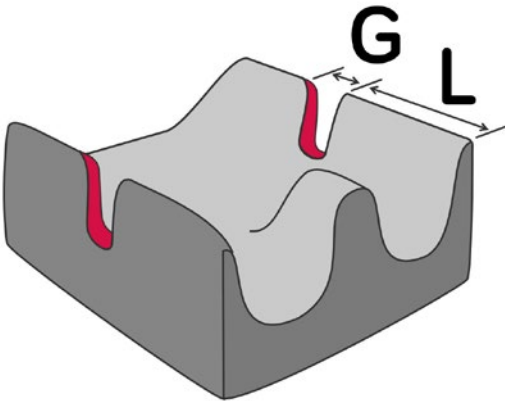

CUSTOMISATIONS

A large rectangular area filled with a red grid pattern, intended for drawing or writing customisation details.

Pelvis/Ischial Area 1111-0351-000

SIZE
AUTOMATIC
 (size changes proportionate to cushion size)

POSITION
CENTRAL

OBLIQUITY BUILD UP

L BUILD-UP **R BUILD-UP**

Using Spex Strategic Base Pads (complete diagram on page 13)

Custom Support Build-Up (complete diagram below)

CUSTOM WIDTH (W)
 _____ mm

CUSTOM LENGTH (L)
 _____ mm

OFFSET POSITION
L | R by _____ mm

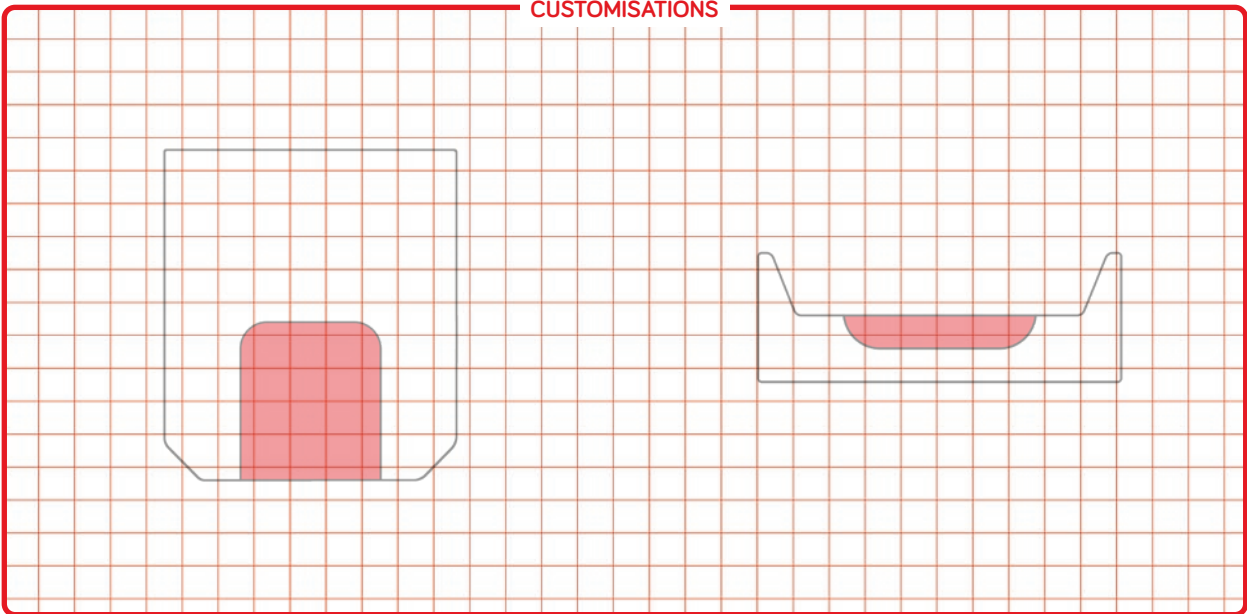
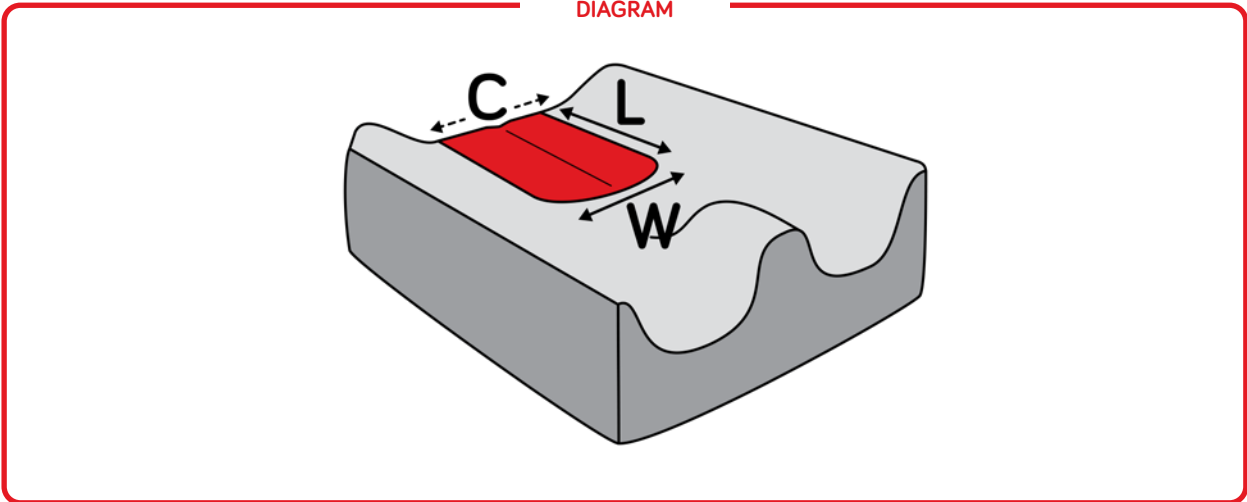

PADDING INSERT OPTIONS



*Air insert to be sourced by customer and supplied to Medifab to be fitted within cushion at time of manufacture. Printed copies of customer's purchase order and Medifab's order confirmation must be enclosed with goods.

Outer Cover Material

Custom Build Your Own Cushions include one incontinence cover and two outer covers



DUAL FABRIC

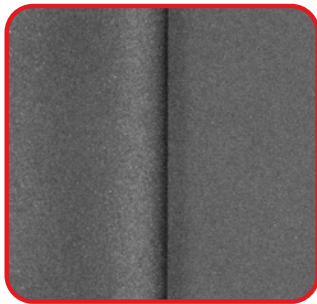

Extremely pliable fabric layers on both sides that stretch well and retain their shape over time. Breathable fabric option.

SPEXTEX WATERPROOF PU

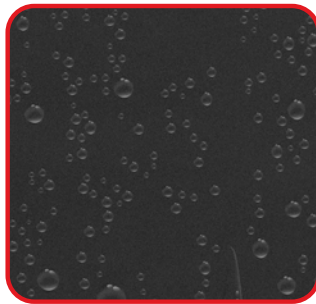

Extremely pliable and will stretch well. Synthetic polyurethane on one side and knitted layer on the other. Non-breathable fabric option.

SPEXTEX KNITTED FABRIC

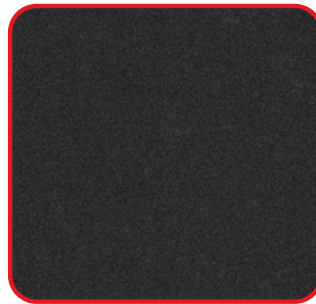

Extremely pliable and will stretch well. Synthetic polyurethane on one side and knitted layer on the other. Non-breathable fabric option.

MERINO



A superior insulator and temperature regulator. Breathable allowing heat and moisture to flow meaning a drier and more comfortable fabric.

USER CONTACT SURFACE (TOP OF CUSHION)

DUAL FABRIC
(default)

SPEXTEX WATERPROOF PU
(1111-0399-209)

SPEXTEX KNITTED FABRIC
(1111-0399-219)

MERINO
(1111-0399-330)

BORDER FABRIC (SIDE PANELS)

DUAL FABRIC
(1111-0491-286)

SPEXTEX WATERPROOF PU
(1111-0491-209)

SPEXTEX KNITTED FABRIC
(1111-0491-219)

AIR MESH
(default)

Select Air Mesh Colour

Black
(default)

Chilli
-022

Mango
-030

Calypso
-028

Royal
-077

Bumblebee
-044

Ocean
-060

Leaf
-054

Granite
-090

Options

5-DEGREE CUSHION WEDGE (UNGLUED)

1209-2724-300

Made to fit specified cushion

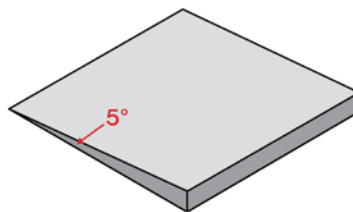

EXTRA CUSHION POSITIONING PADS KIT

1111-0273-000

Comes as a kit

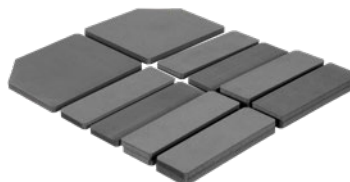

BARIATRIC CUSTOMISATION

Specify users weight

WEIGHT

----_kg



Additional Notes

Contouring Chart

PLEASE COMPLETE IF YOU WOULD LIKE YOUR CUSHION TO BE PRE-CONTOURED

User's right leg	Front of cushion	User's left leg
Enter number of contouring pads:		Enter number of contouring pads:
Enter number of contouring pads:		Enter number of contouring pads:
Enter number of contouring pads:		Enter number of contouring pads:
Enter number of contouring pads:		Enter number of contouring pads:
Enter number of contouring pads:		Enter number of contouring pads:
Enter number of contouring pads:		Enter number of contouring pads:
Enter number of contouring pads:		Enter number of contouring pads:
Enter number of contouring pads:		Enter number of contouring pads:

Back of cushion

spex

Spex Ltd

32 Detroit Drive
Rolleston 7675
New Zealand

+64 3 307 9790

solutions@spexseating.com

www.spexseating.com



DISTRIBUTED BY:

US	REP	EC	REP
Medicept 200 Homer Ave, Ashland MA 01721, United States Tel: +1-508-231-8842		BEO MedConsulting Berlin GmbH Helmholtzstr. 2 D-10587 Berlin, Germany Tel: +49-30-318045-30	



Script: Custom Cushion 20211006