

Assembly skills, screws are preferred. (X2 ▲▲) Means: assemble 2 and horizontally symmetrical.

(X2 ▲▲) Means: assemble 2 and the direction is the same.

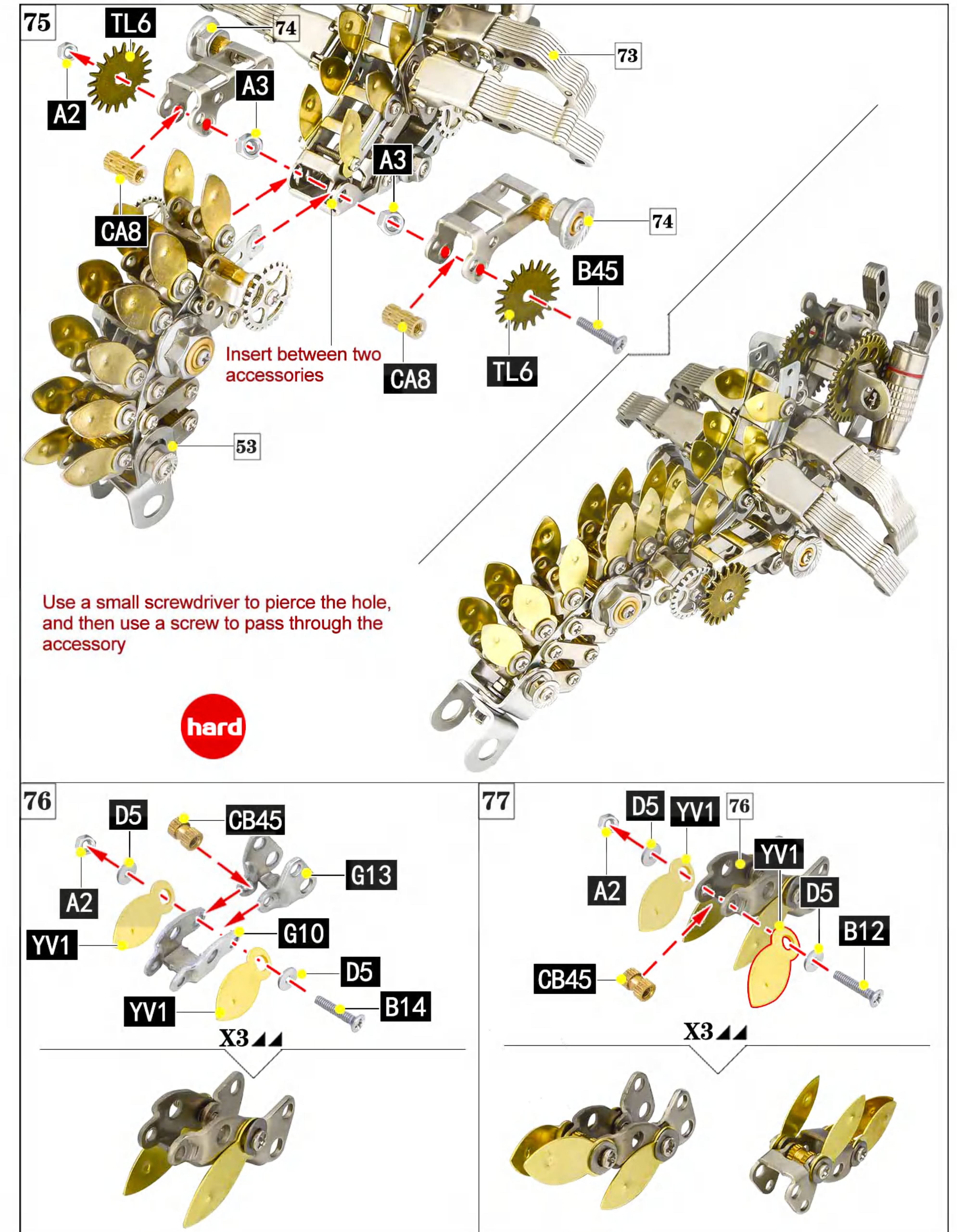

Assembly skills, screws are preferred. (X2 ▲▲) Means: assemble 2 and horizontally symmetrical.

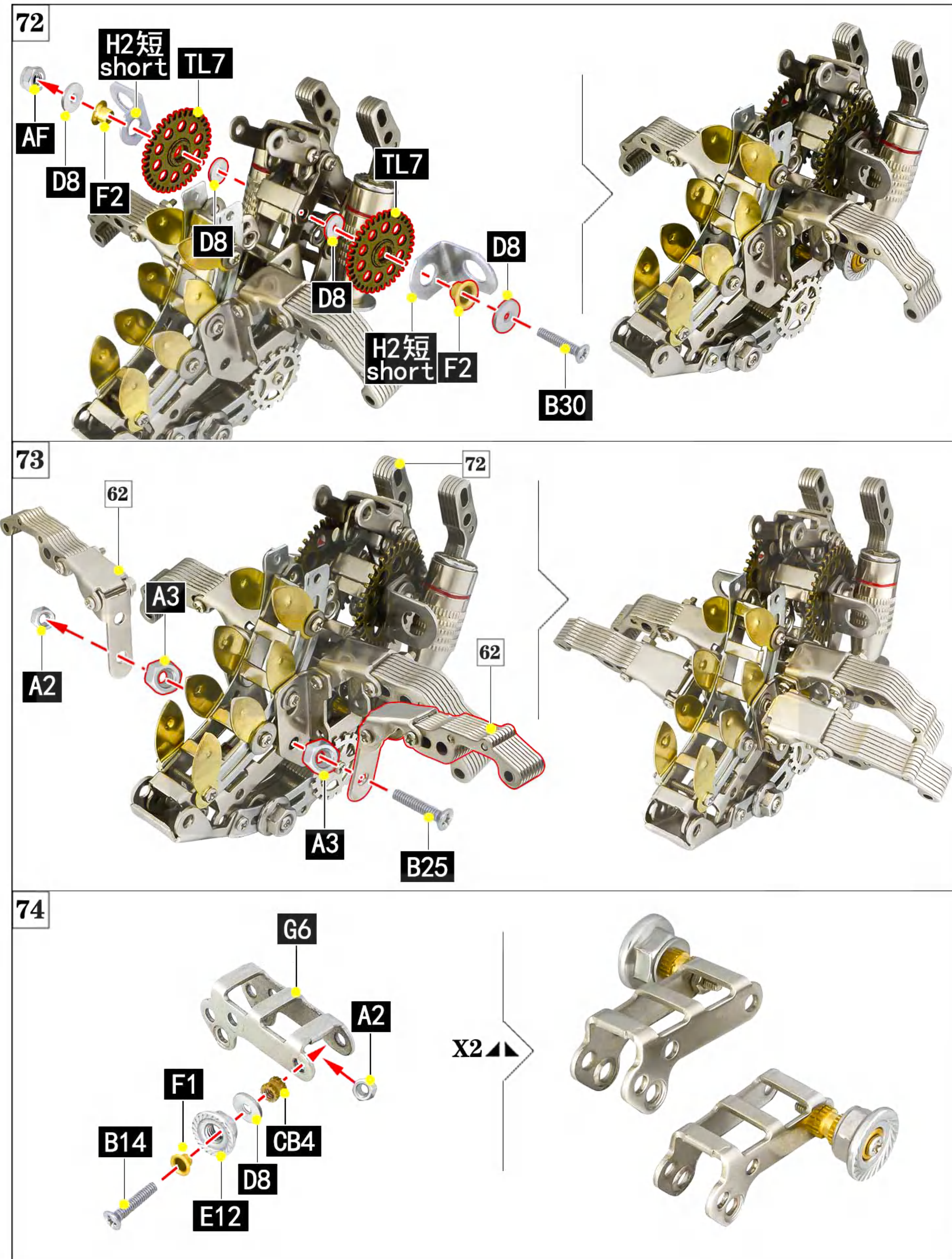
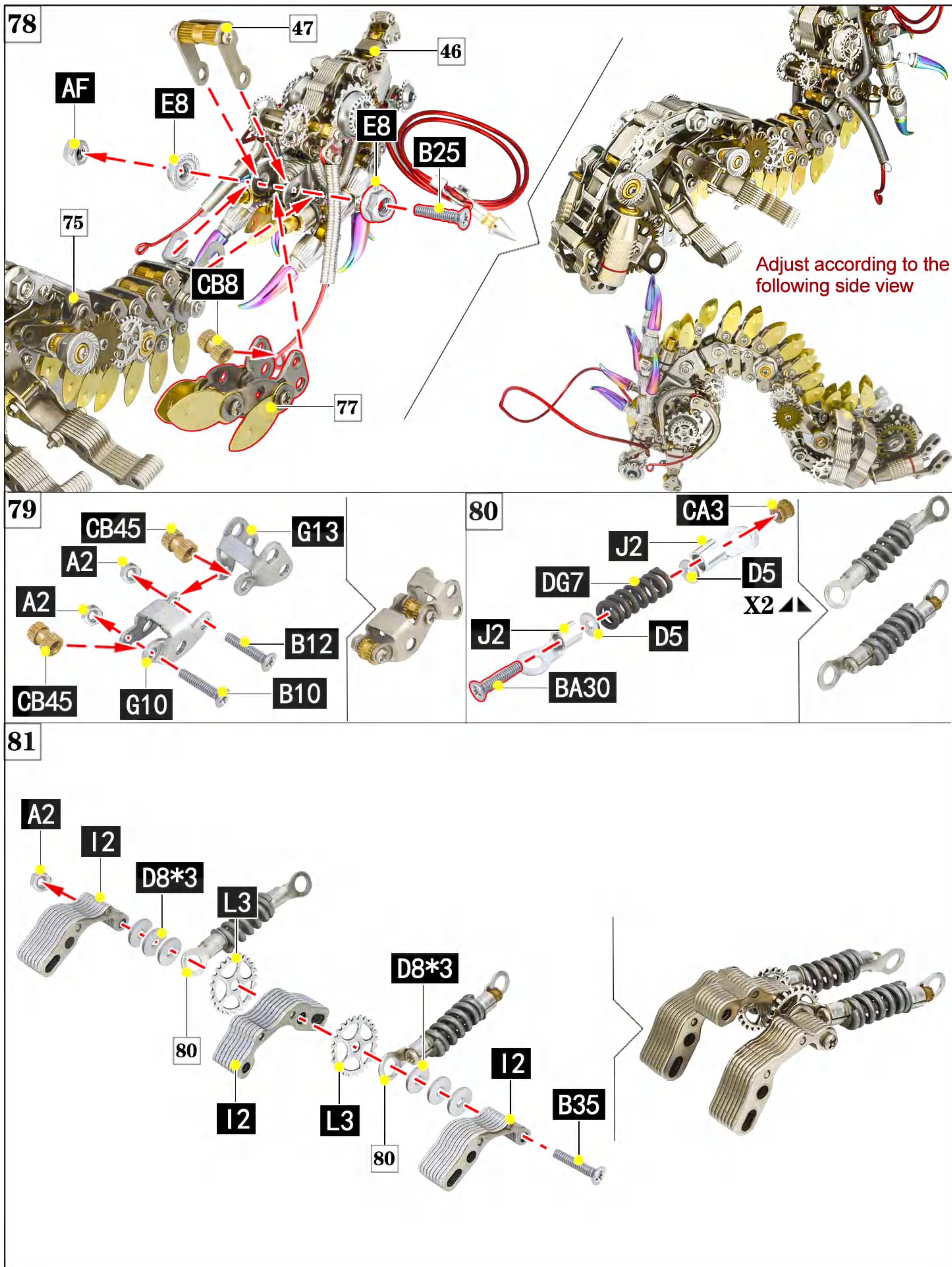

(X2 ▲▲) Means: assemble 2 and the direction is the same.

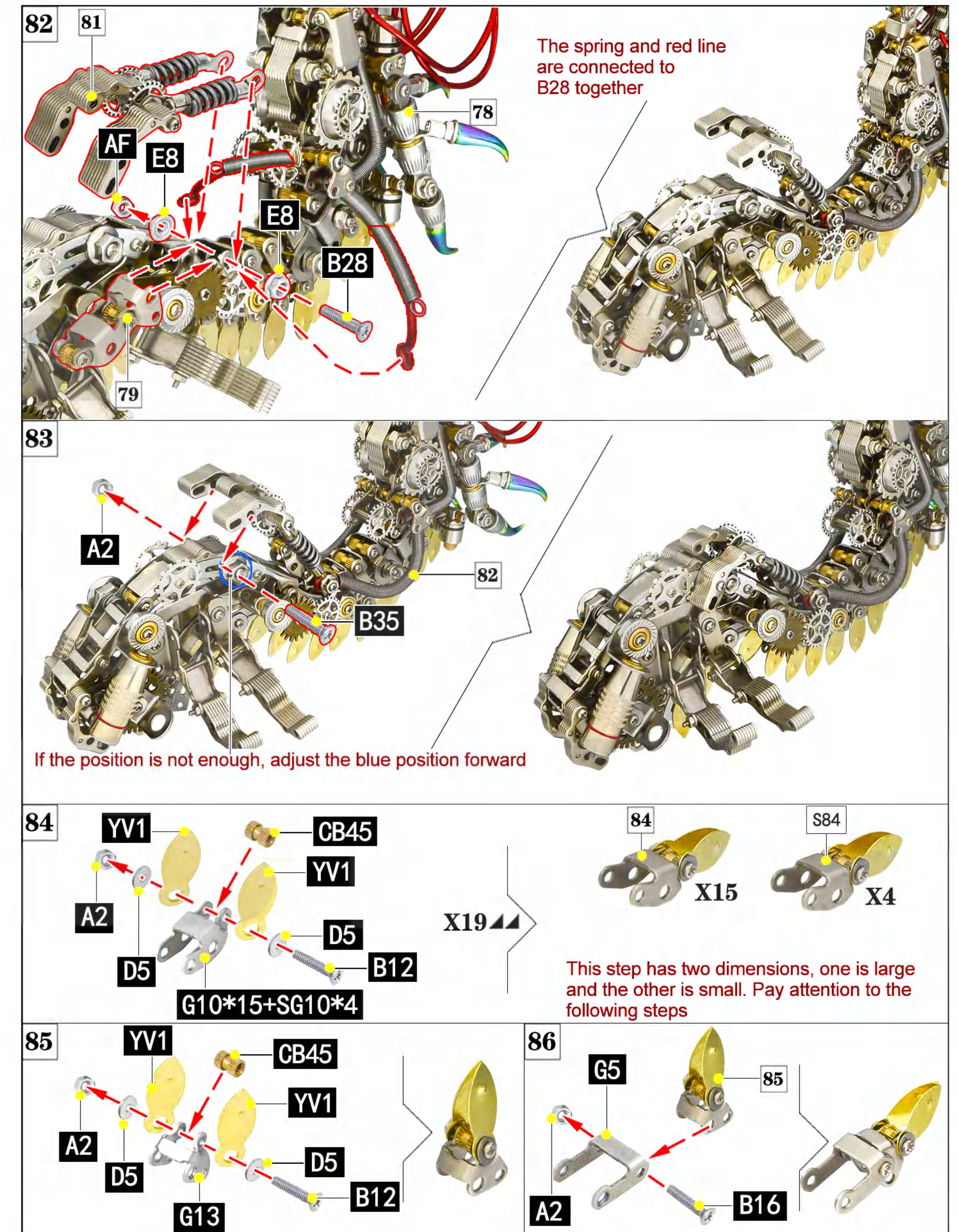

Assembly skills, screws are preferred. (X2 ▲▲) Means: assemble 2 and horizontally symmetrical.

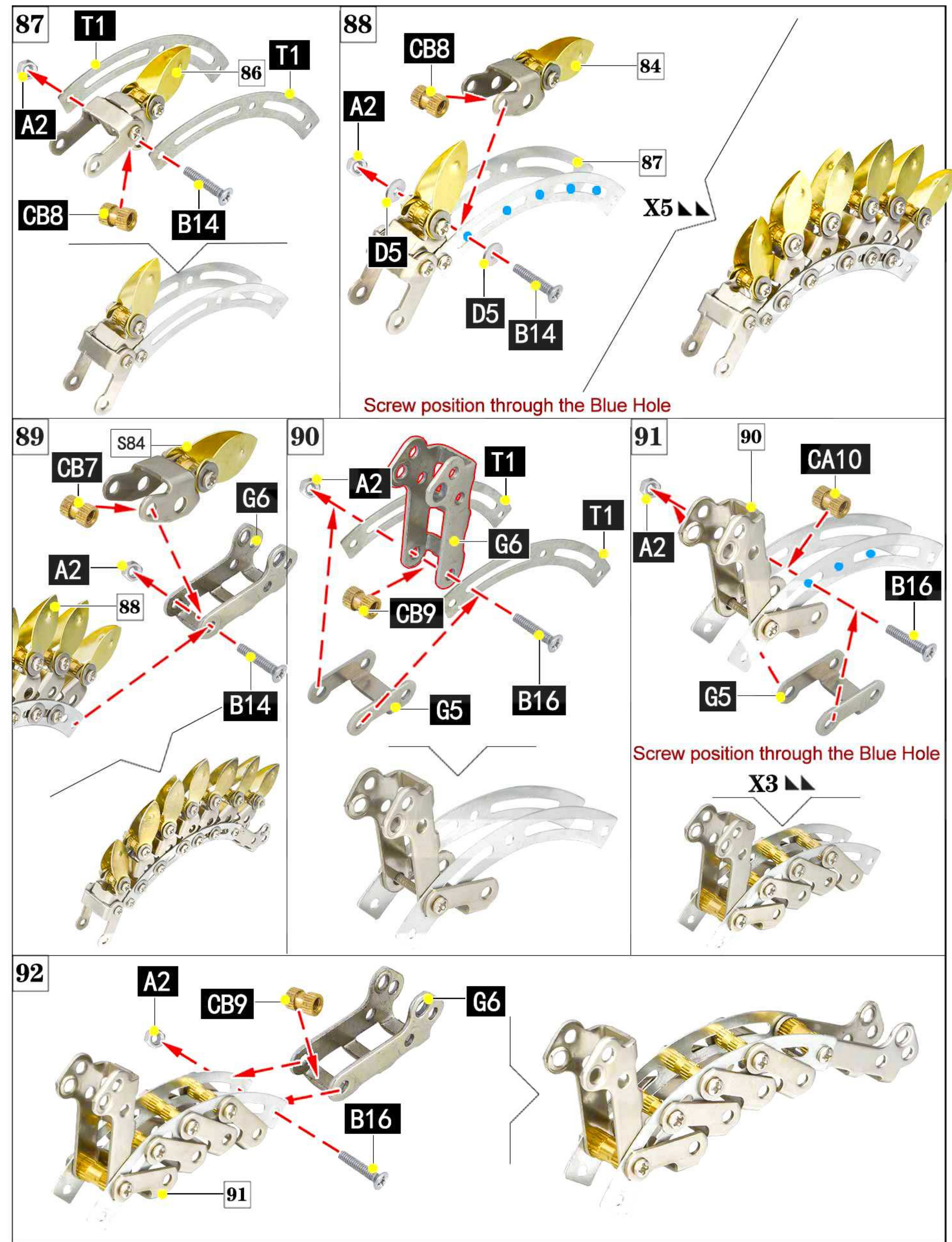

(X2 ▲▲) Means: assemble 2 and the direction is the same.

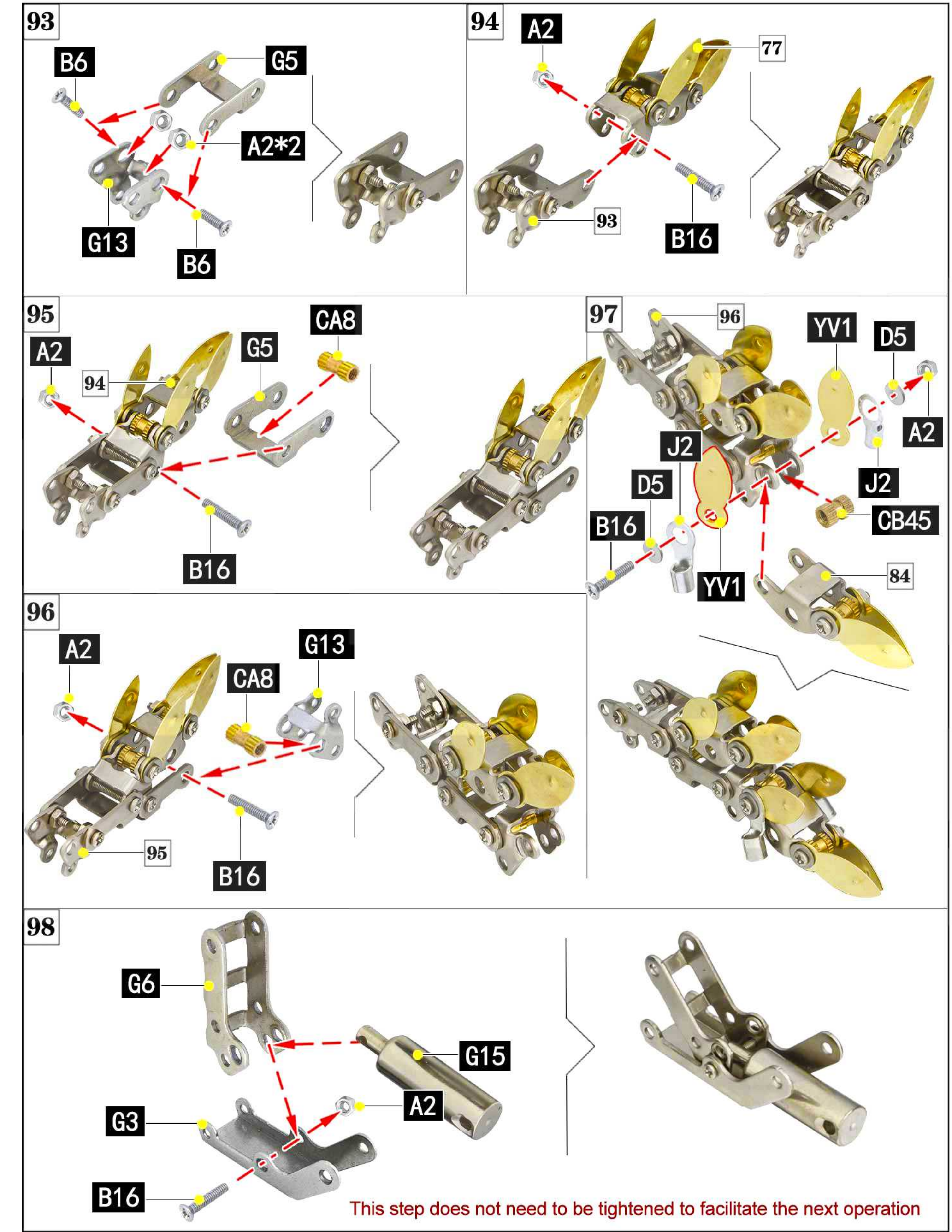

Assembly skills, screws are preferred. (X2 ▲▲) Means: assemble 2 and horizontally symmetrical.

(X2 ▲▲) Means: assemble 2 and the direction is the same.

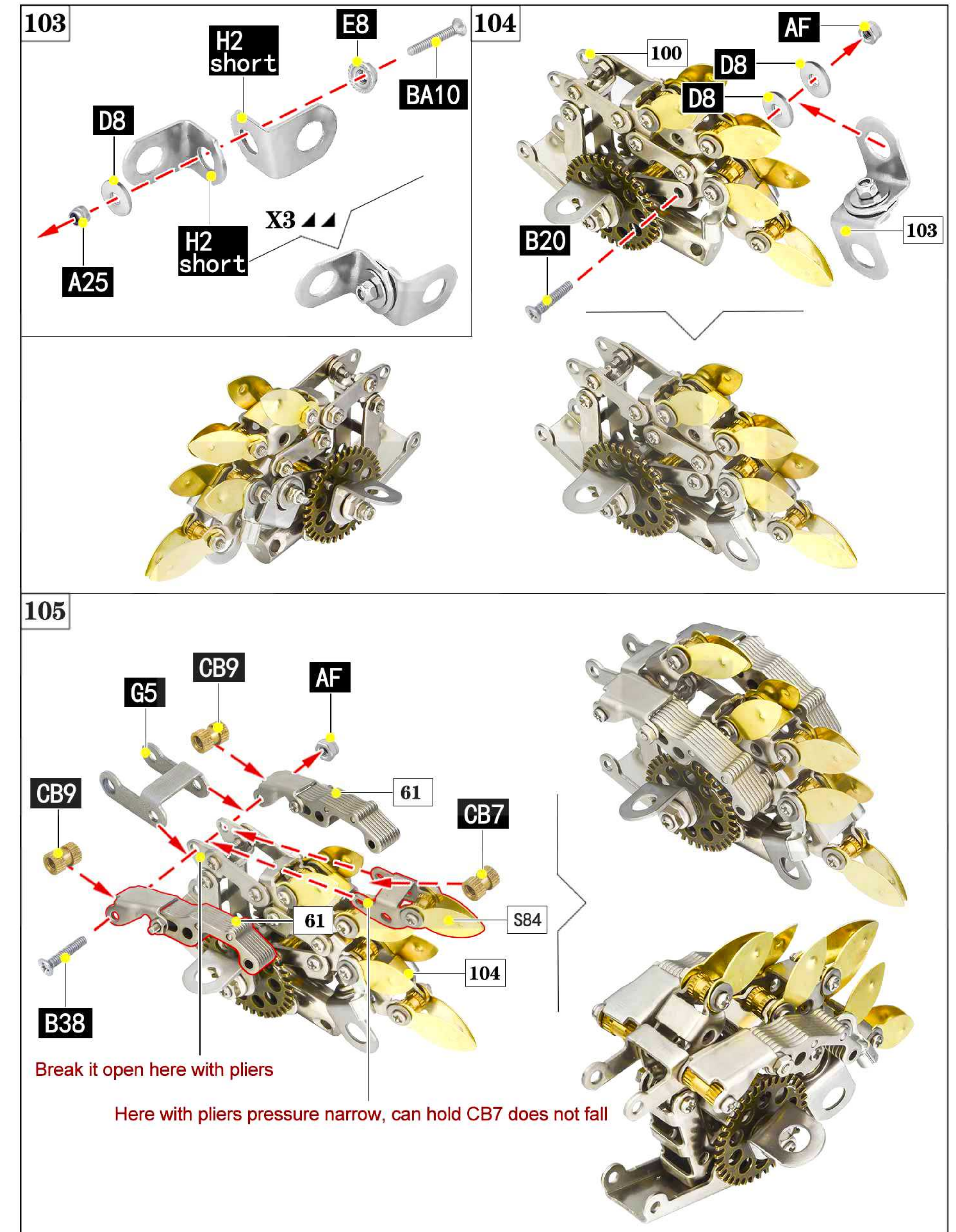
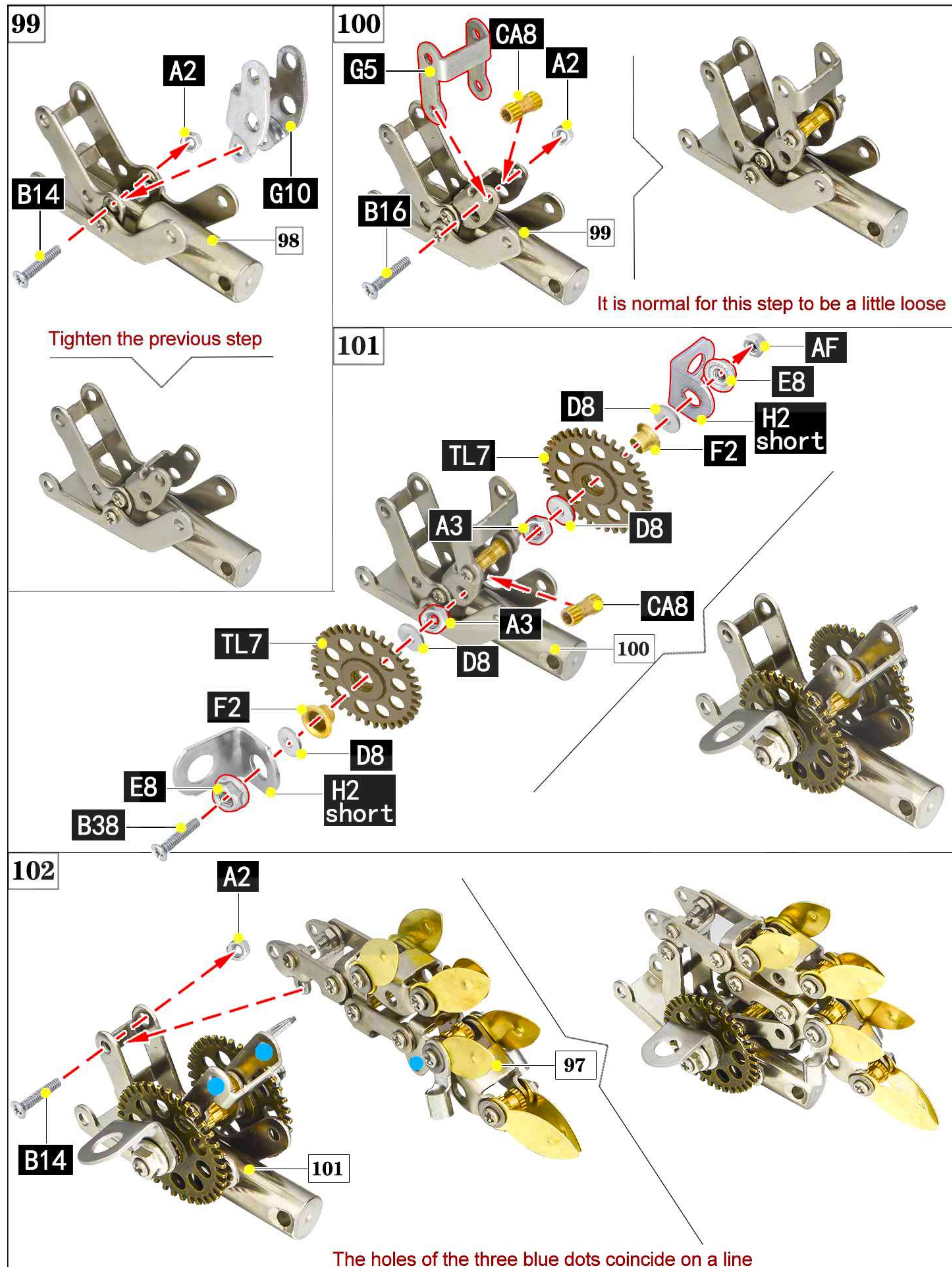

Assembly skills, screws are preferred. (X2 ▲▲) Means: assemble 2 and horizontally symmetrical.

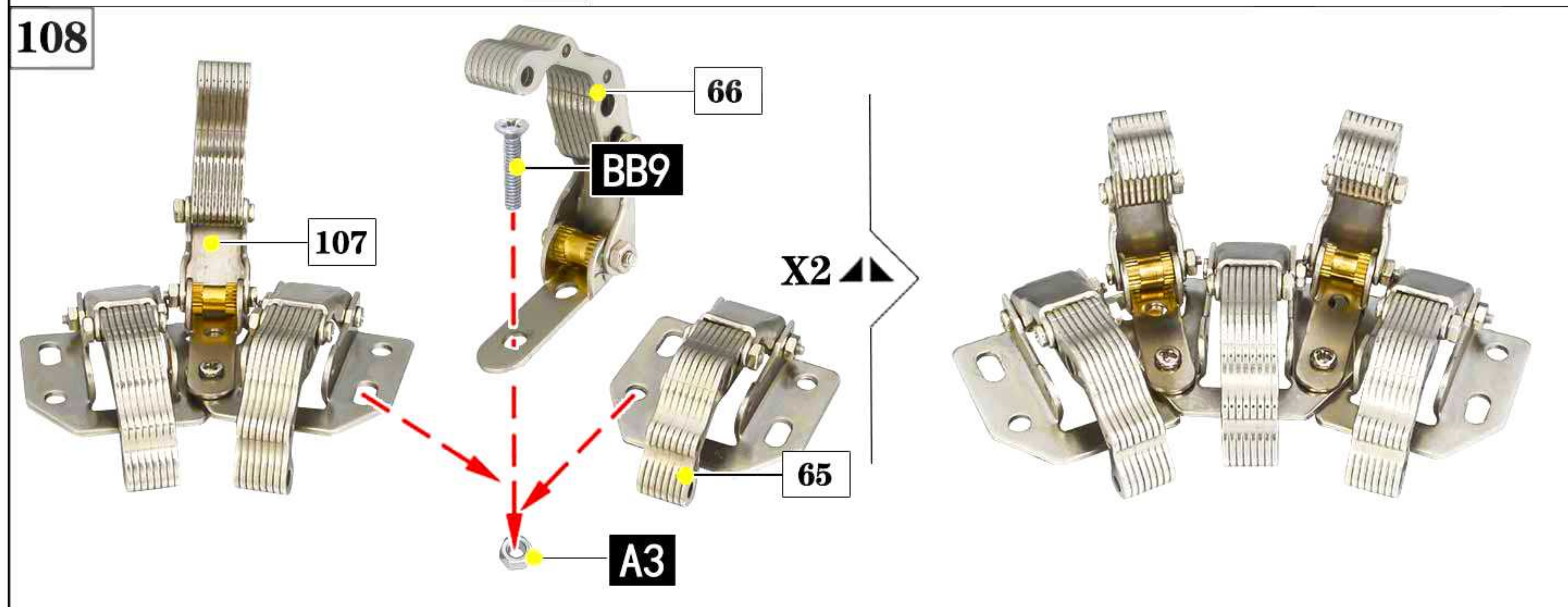
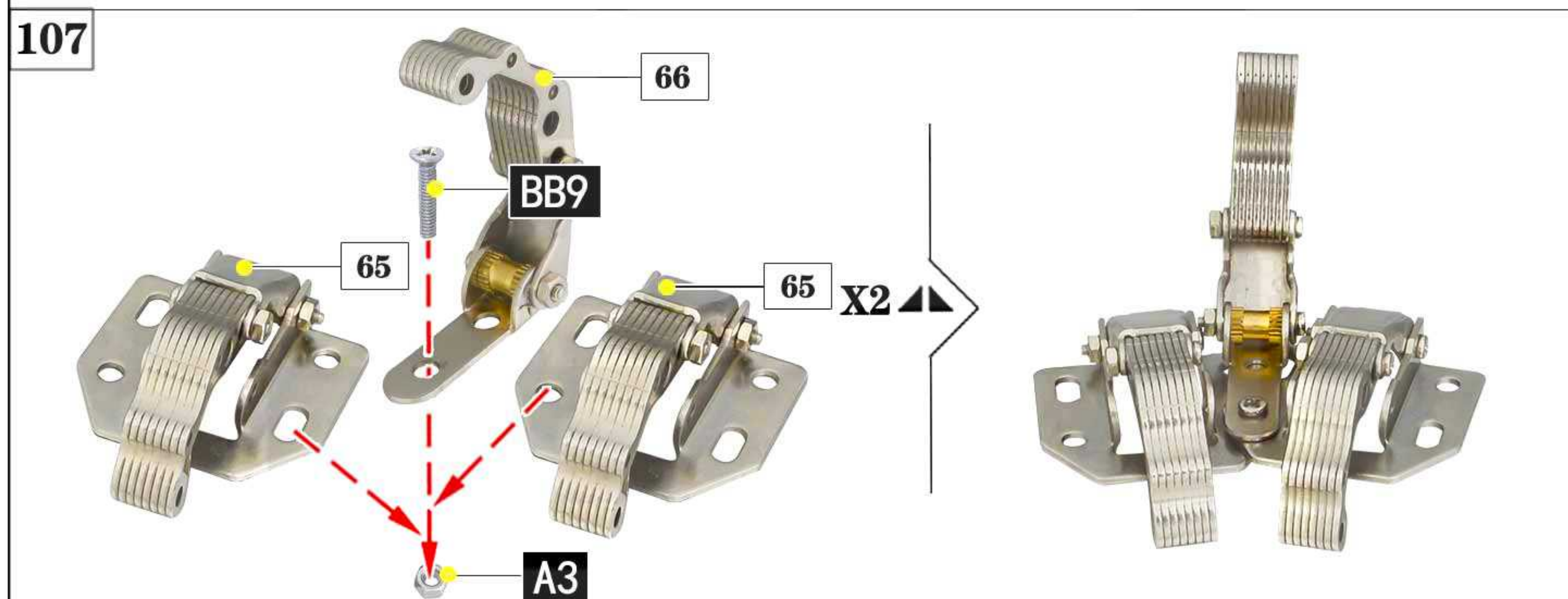
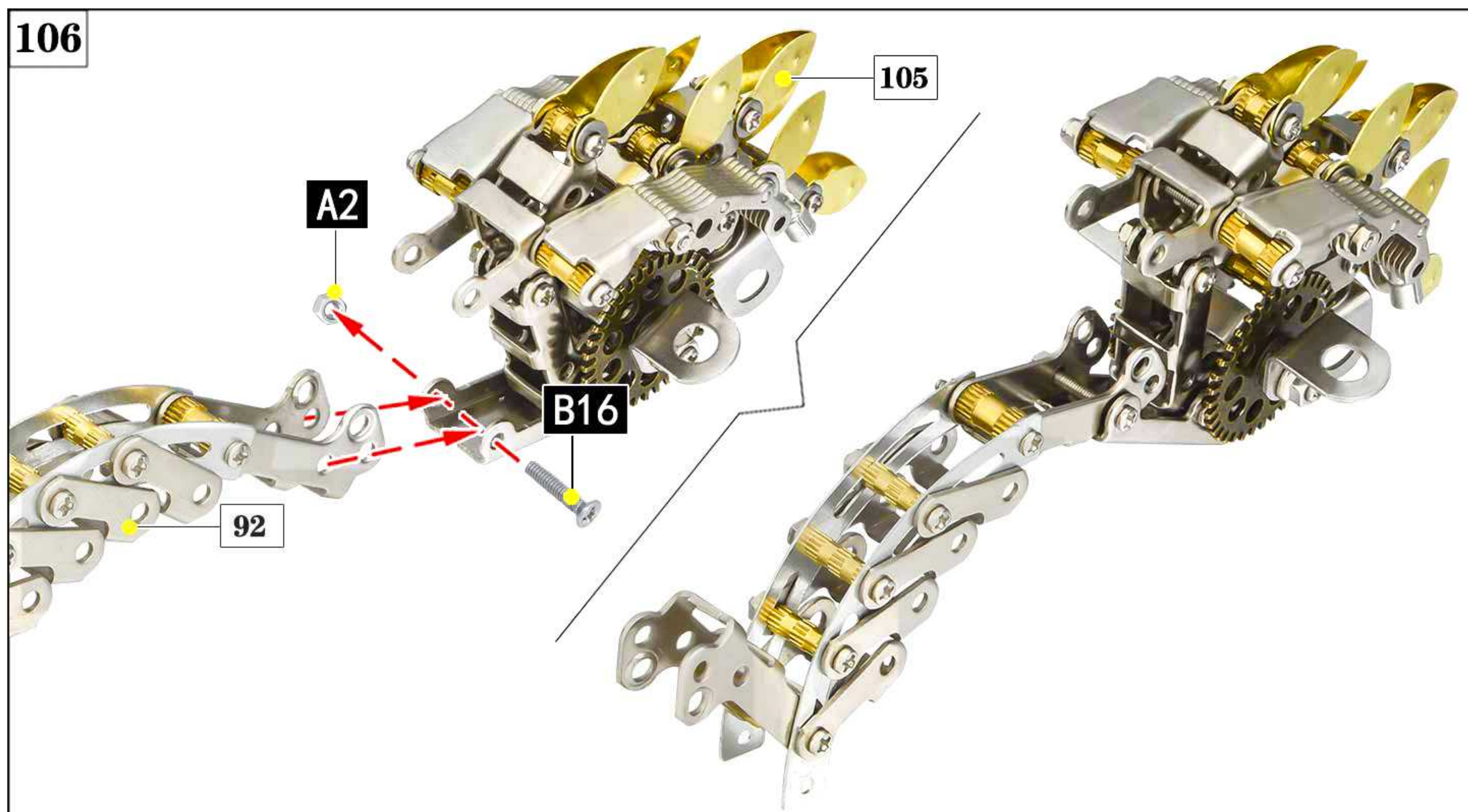

(X2 ▲▲) Means: assemble 2 and the direction is the same.

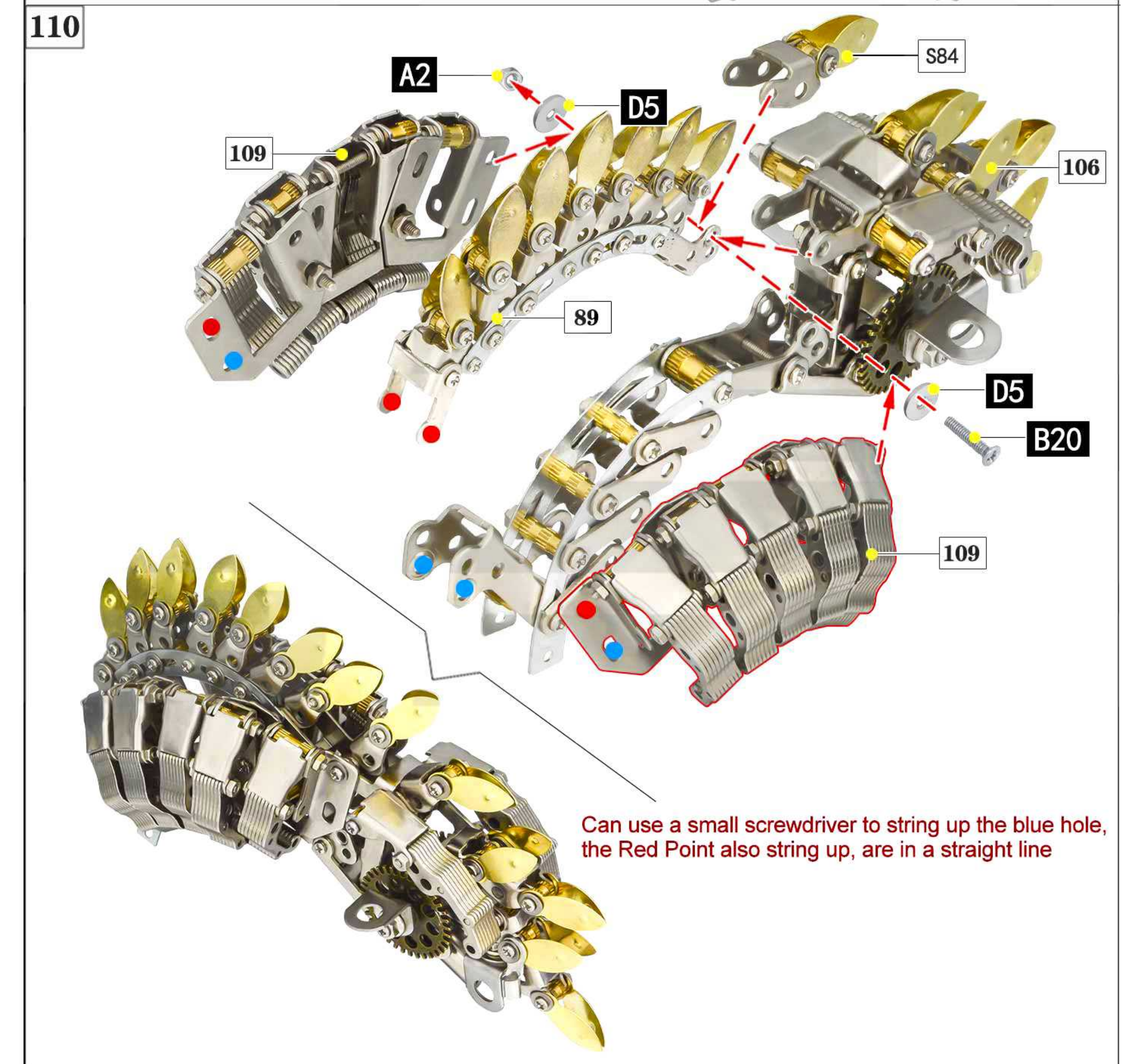
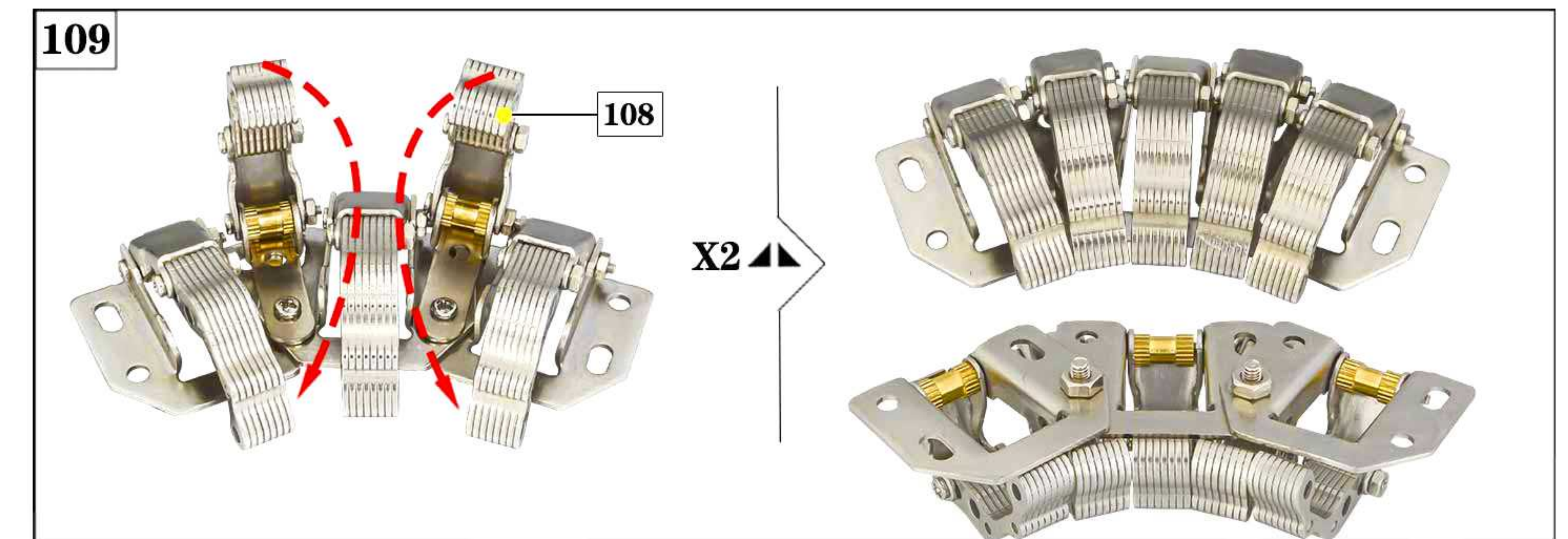

Assembly skills, screws are preferred. (X2 ▲▲)Means: assemble 2 and horizontally symmetrical.

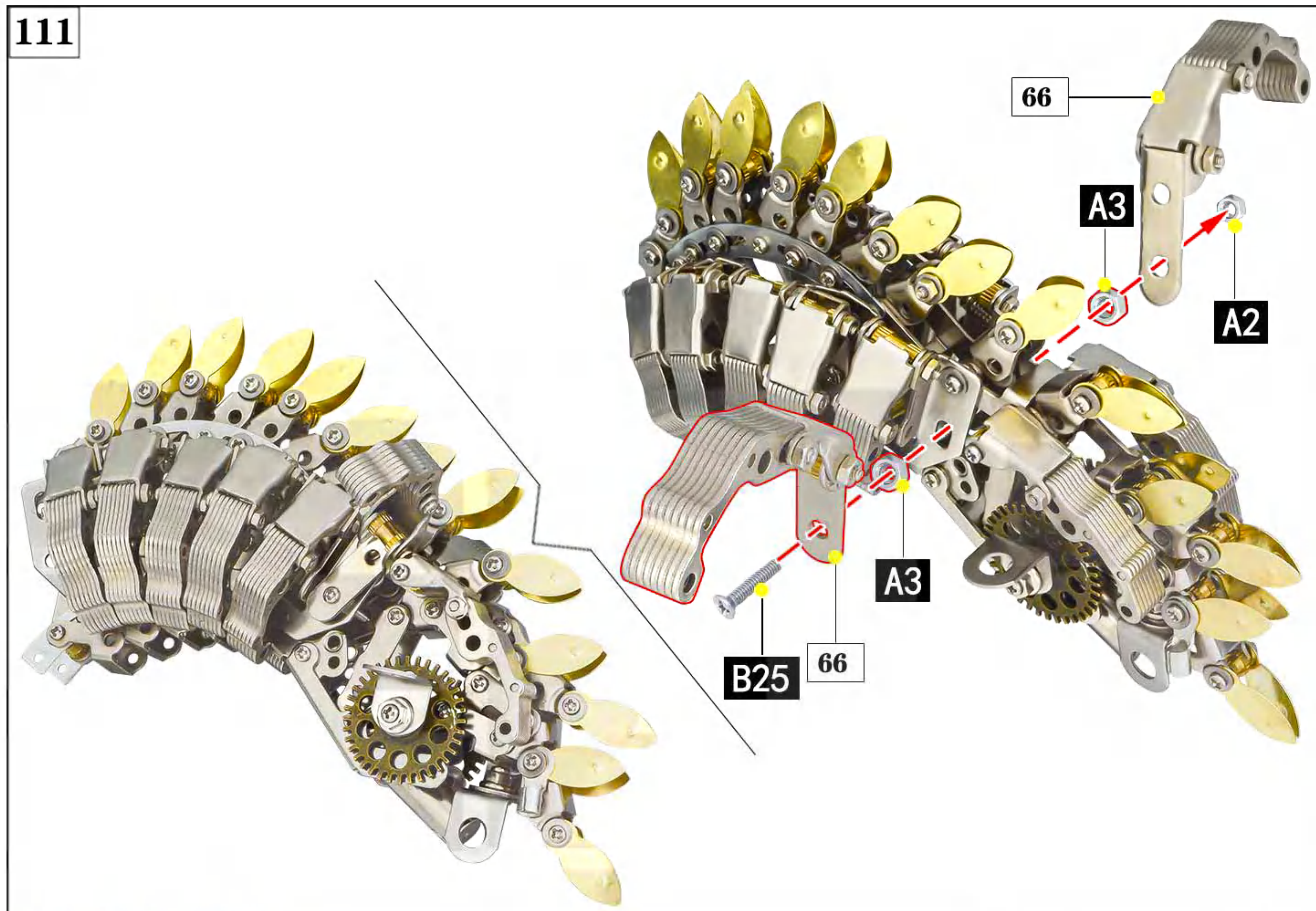

(X2 ▲▲)Means: assemble 2 and the direction is the same.

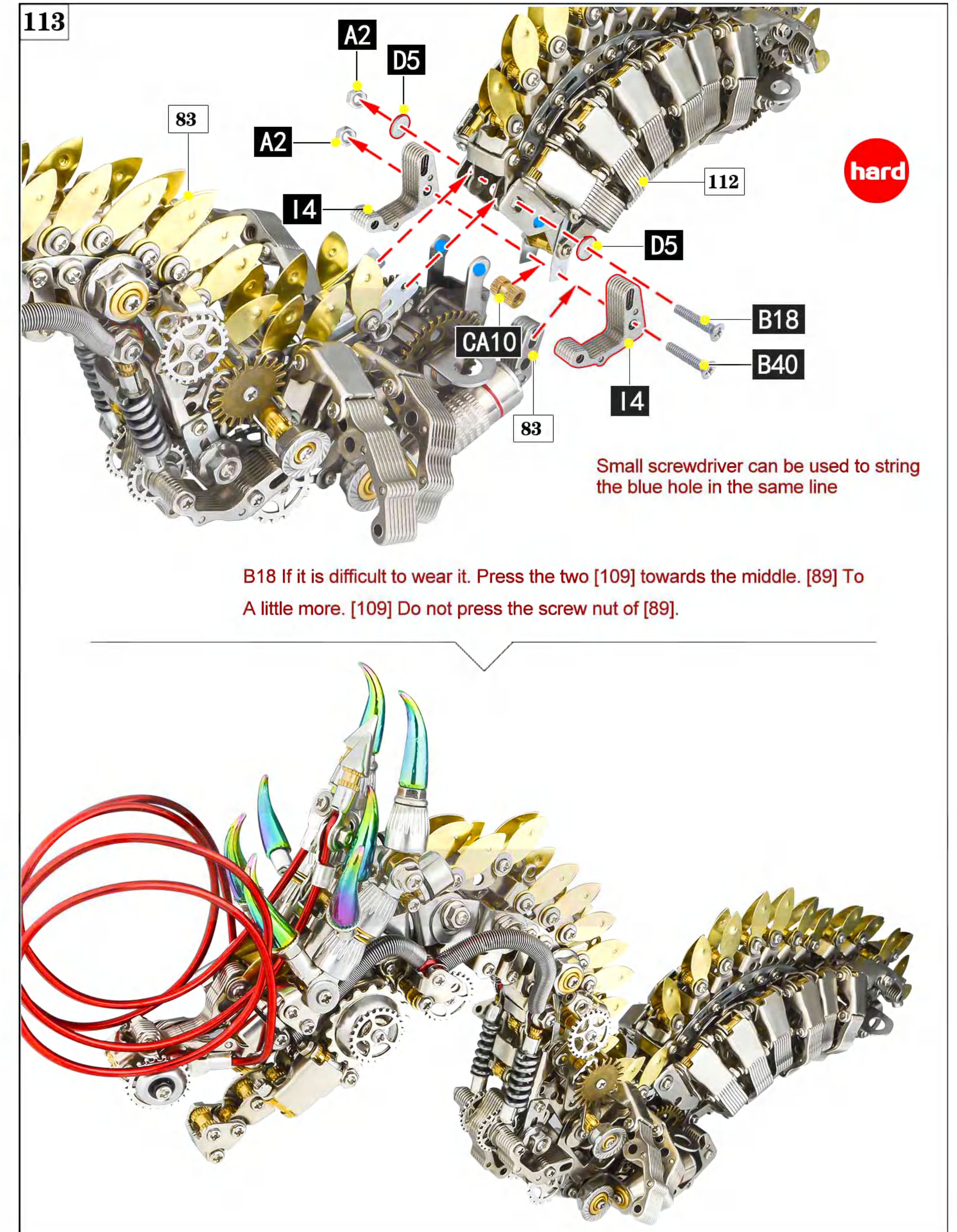

Assembly skills, screws are preferred. (X2 ▲▲) Means: assemble 2 and horizontally symmetrical.

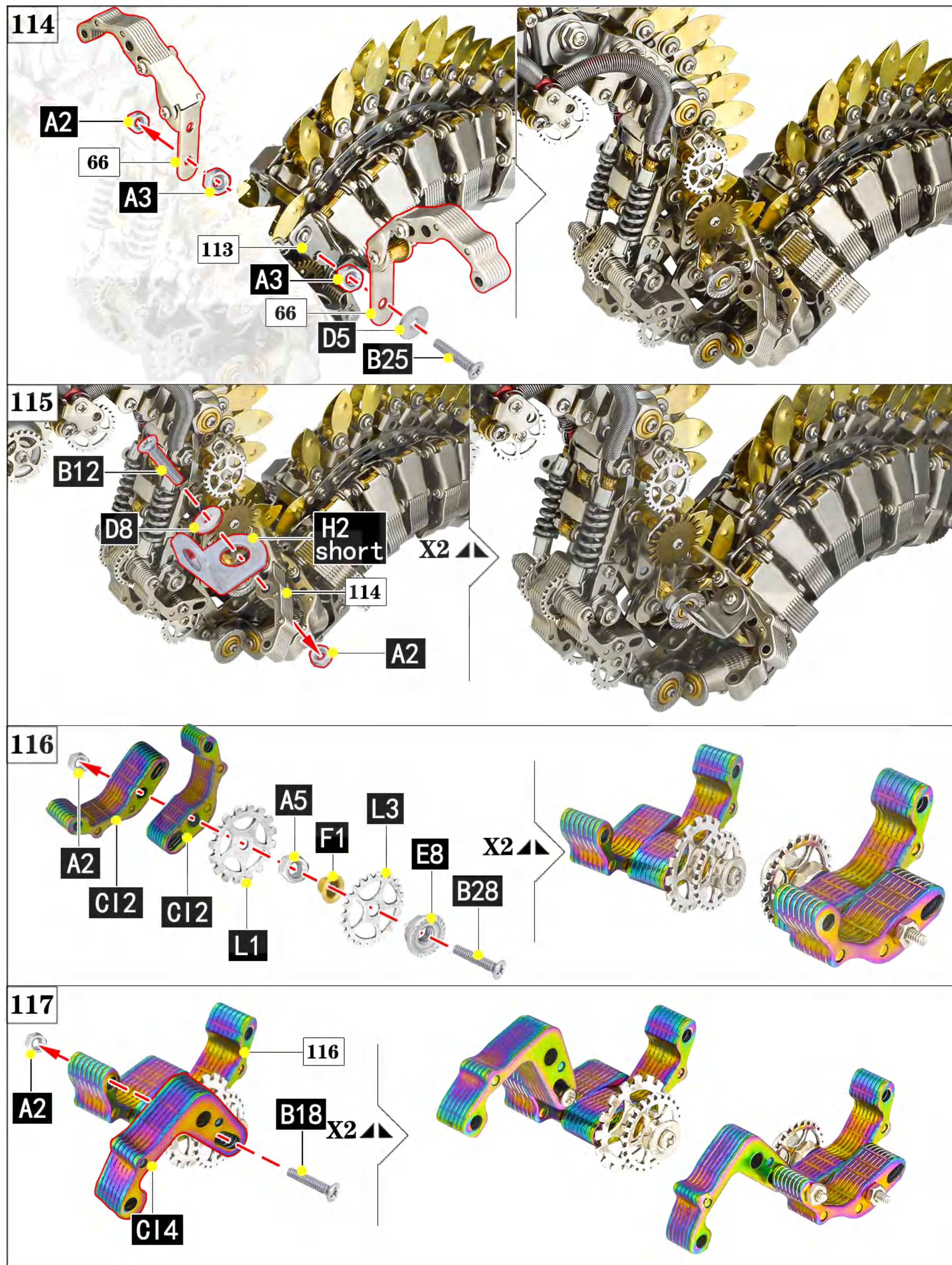

(X2 ▲▲) Means: assemble 2 and the direction is the same.

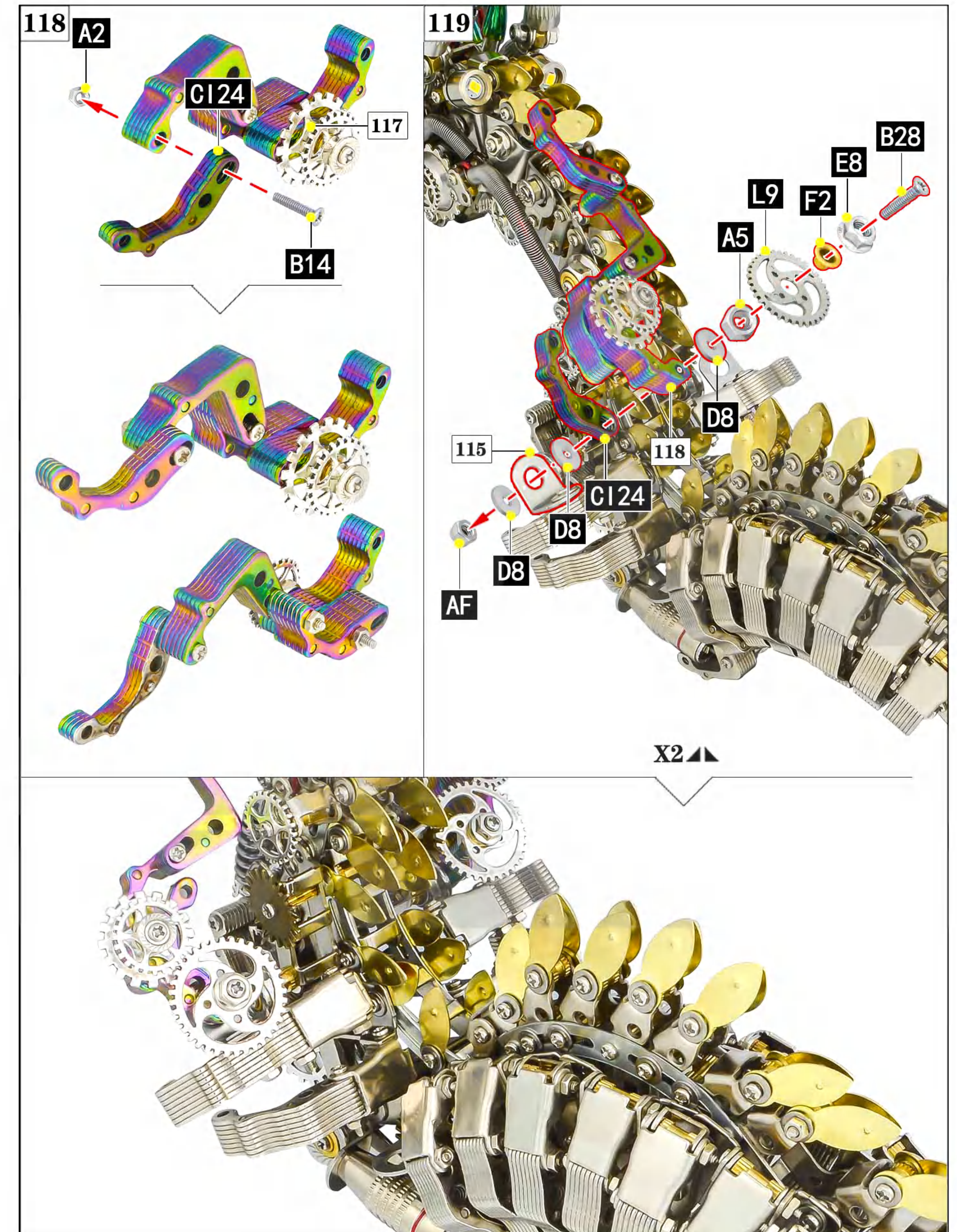

Assembly skills, screws are preferred. (X2 ▲▲) Means: assemble 2 and horizontally symmetrical.

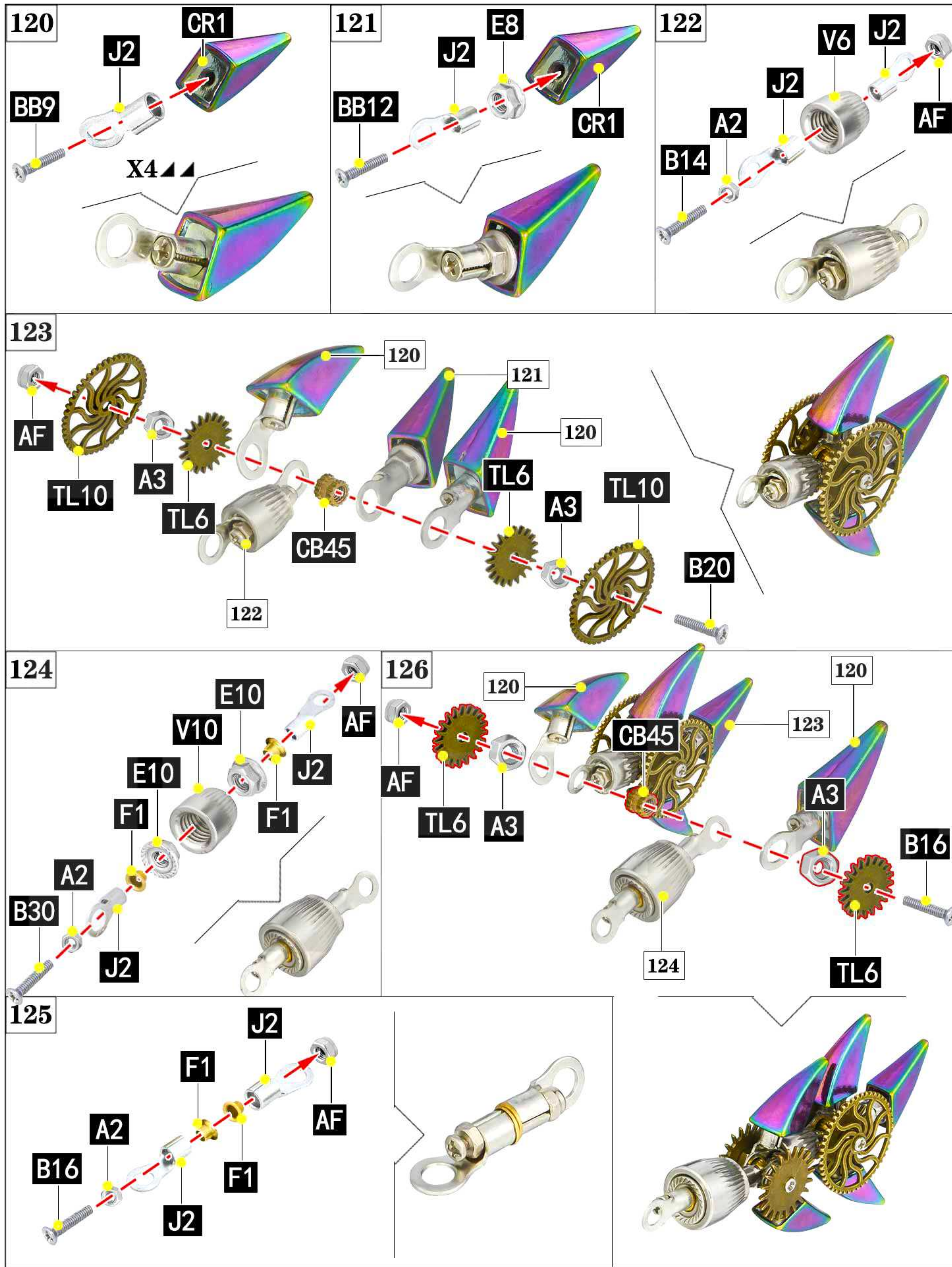

(X2 ▲▲) Means: assemble 2 and the direction is the same.

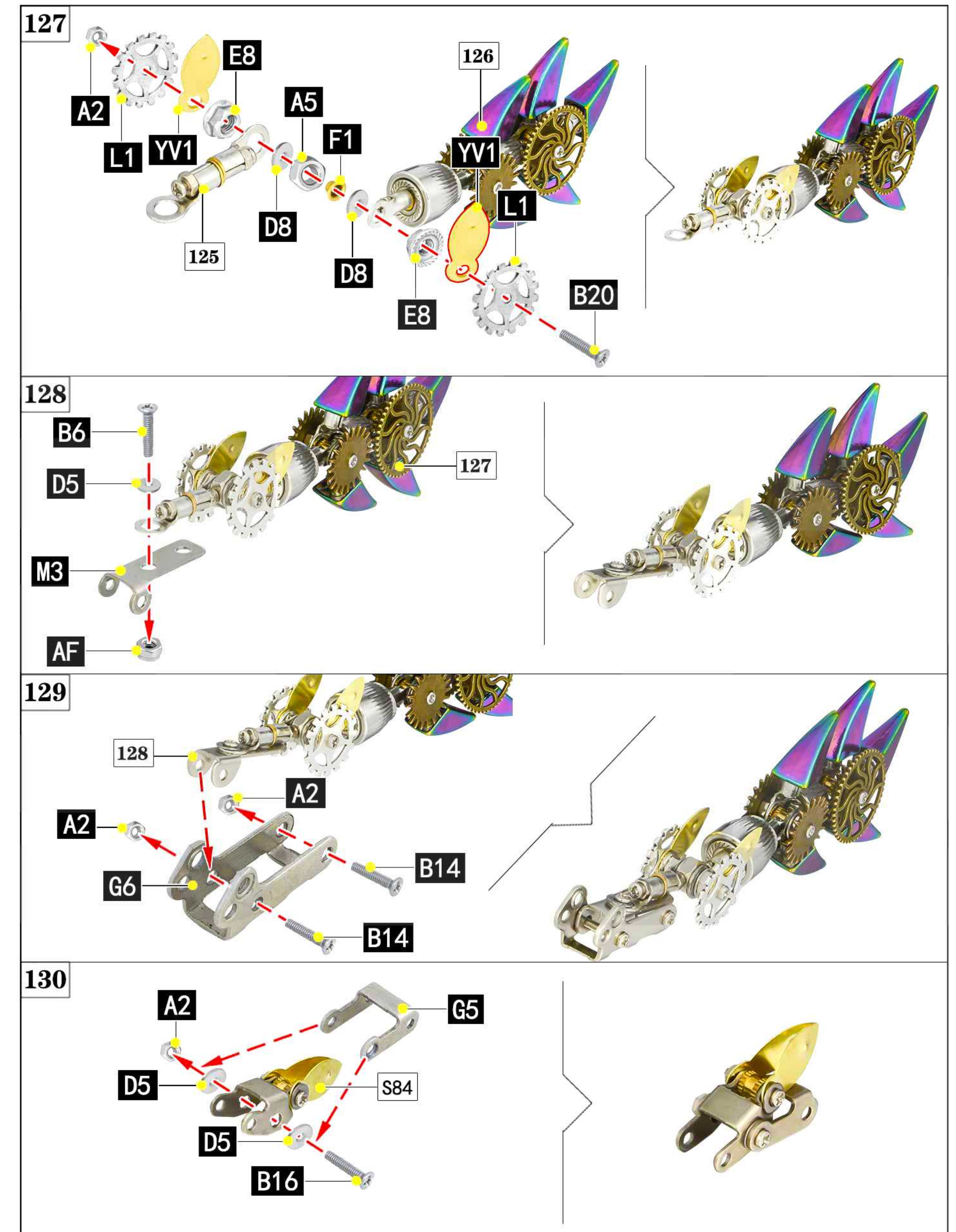



Assembly skills, screws are preferred. (X2 ▲▲) Means: assemble 2 and horizontally symmetrical.

(X2 ▲▲) Means: assemble 2 and the direction is the same.

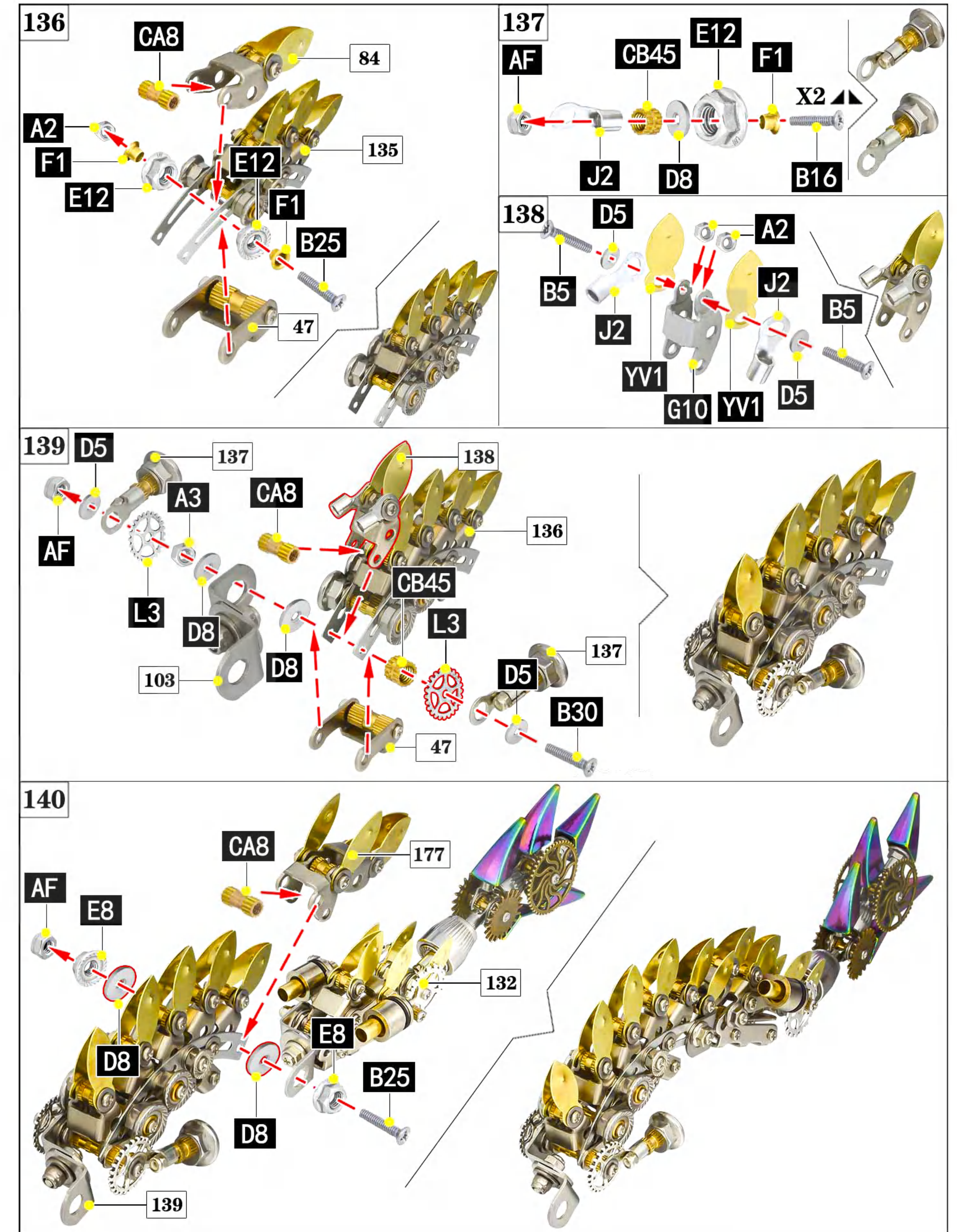
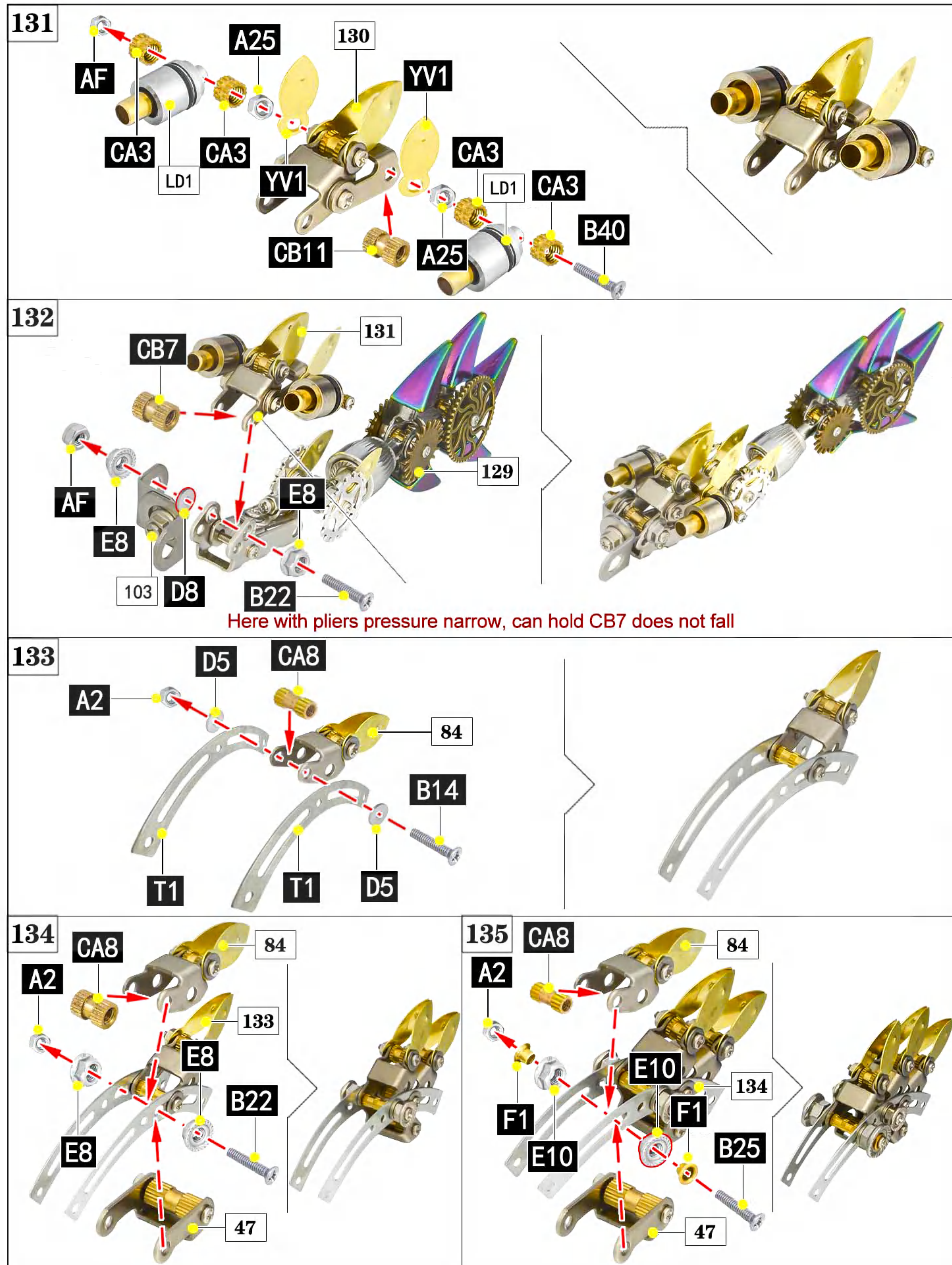

Assembly skills, screws are preferred. (X2 ▲▲) Means: assemble 2 and horizontally symmetrical.

(X2 ▲▲) Means: assemble 2 and the direction is the same.

