

Plasma 2040

USB-C connector

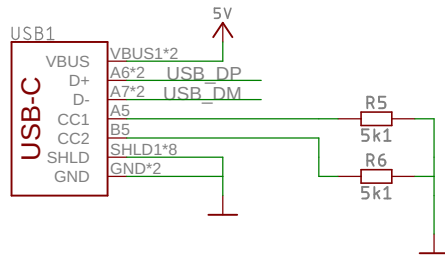

RGB LED

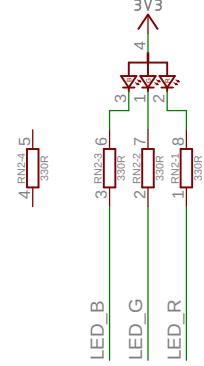

RP2040 MCU

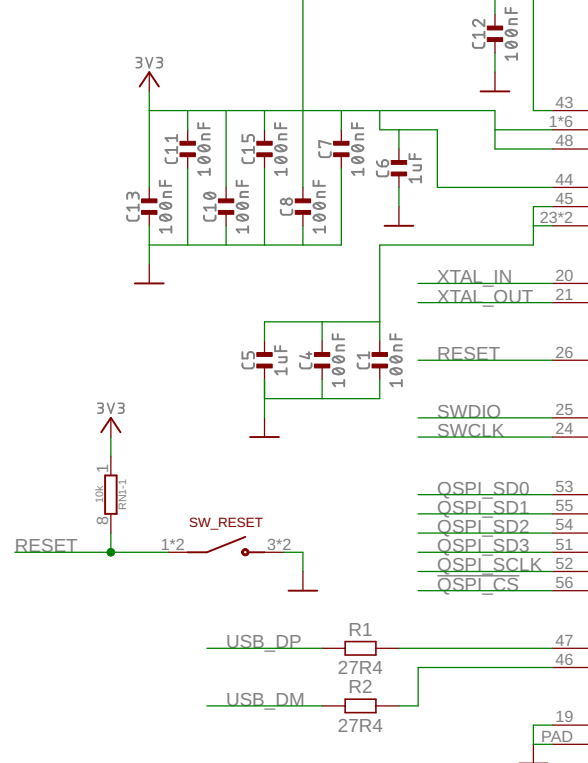

MCU1

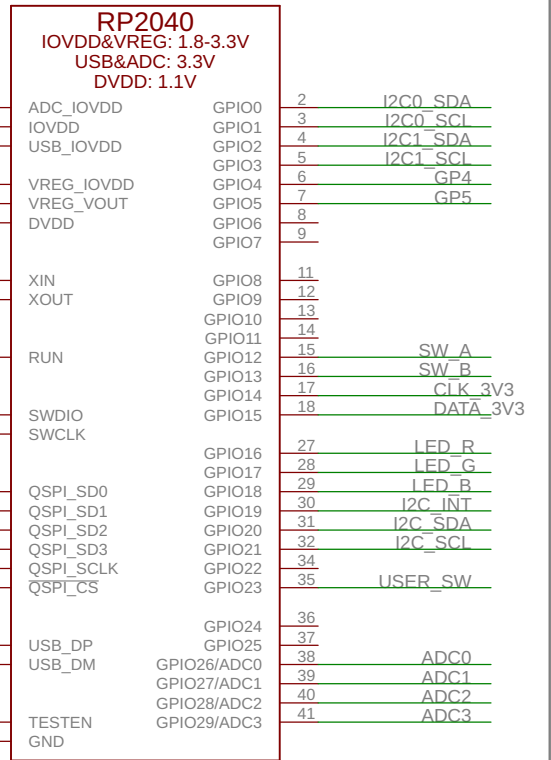

LDO

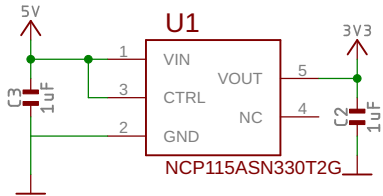

QW/ST connector

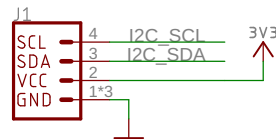

Output level shifting and screw terminal

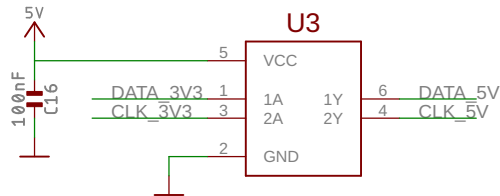

Crystal oscillator

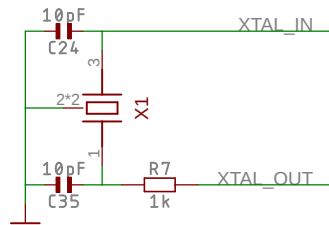

Flash memory

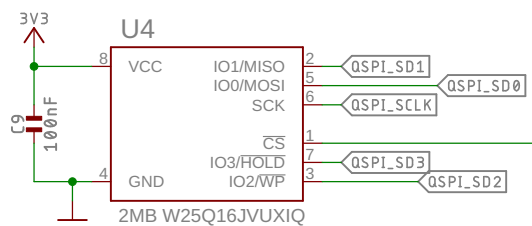

Combined USB boot & user switch

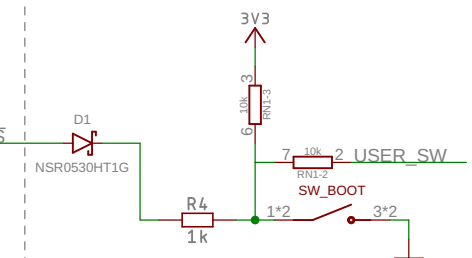

Output screw terminal

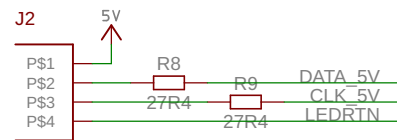

Plasma 2040

Extension header

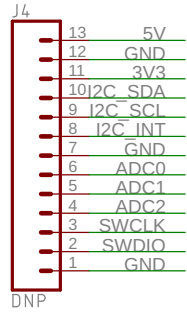

Switches

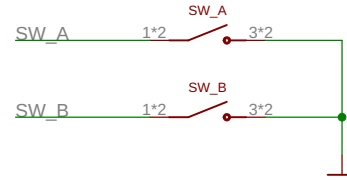

Current sense amplifier

