

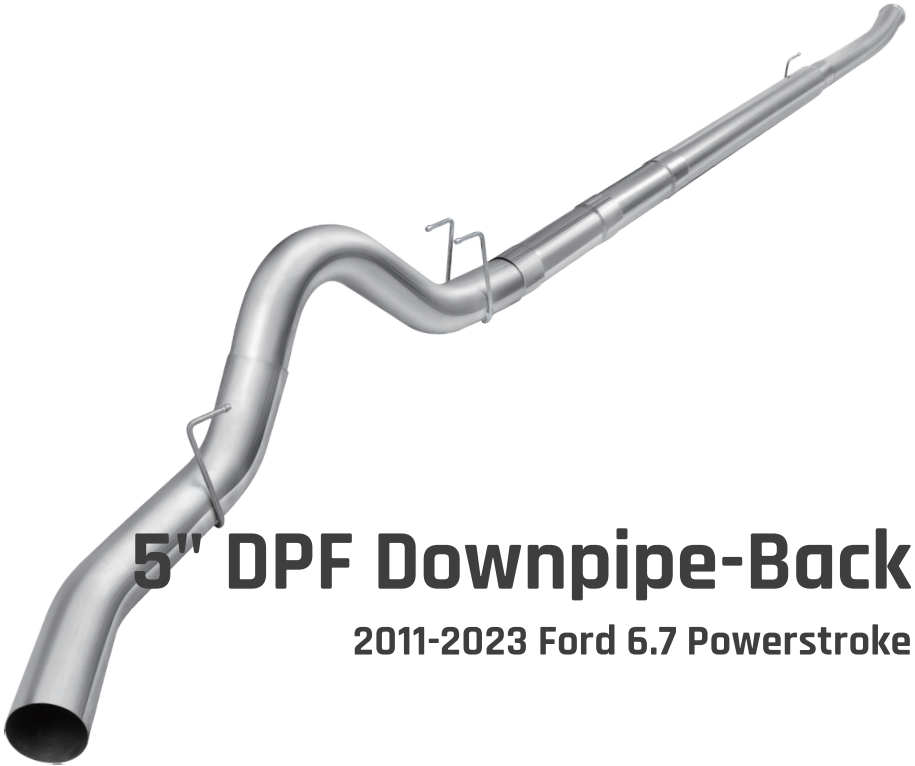





***SPELAB***



# **5" DPF Downpipe-Back**

**2011-2023 Ford 6.7 Powerstroke**

-  Spelab Racing
-  YouTube-SPELAB
-  [service@spelabautoparts.com](mailto:service@spelabautoparts.com)
-  [www.spelabautoparts.com](http://www.spelabautoparts.com)



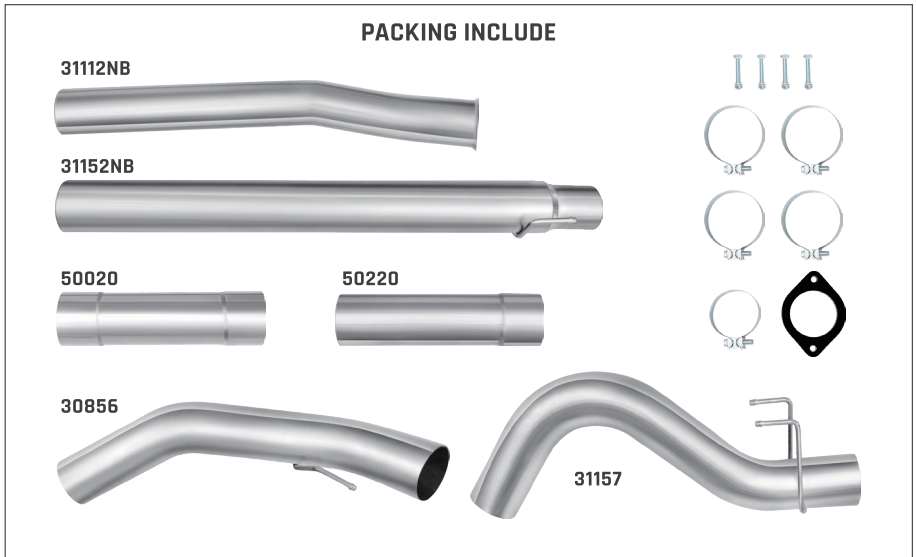

## WARNING

**Warning:** This system is designed for race use only & May also void manufacturer's warranty. Allow the truck's exhaust system to cool before removal. Always practice safe work habits, i.e. jackstands, gloves, safety glasses etc.

**Notes:** Performance Exhaust Systems are redesigned to fit stock trucks with OEM hitches, tires, wheels, and spare sizes. Any suspension lifts or other variations may require modification of the new exhaust system for proper fit and finish. Place clamps on connections before installing pipes. Do not tighten clamps until the complete system is in place. Snug clamp down so it will hold the pipe but pipe can still be moved. WD40 or equal will make removal of hanger easier. A small tack with a mig welder is recommended on all clamp connections.

## INSTALLATION NOTES

**Note:** Prior to installation, please compare the parts that you have received with the bill of materials listed above to ensure that you have all the necessary parts for installation.

## INSTALLATION STEPS

### Step 1:

Removal of OEM Exhaust Systems. Starting at the flanged end of down pipe unbolt the flange connection and all clamps from the rear of particulate filter to tail pipe. Remove the metal hangers from OE rubber hangers and all line/sensors from particulate filter. Remove the OE system from truck. Removal of tailpipe section will be easier with rear wheels hanging freely if cutting tailpipe is not wanted.

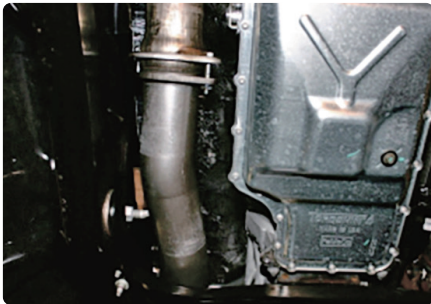

### Step 2:

Install 31112NB pipe by loosely tightening the flanges together at end of downpipe.



### Step 3:

Next, install 31152NB pipe and support with a stand.

### Step 4:

Install over the axle pipe and tailpipe placing metal hangers into OE rubber mounts. NOTE: Your tailpipe is made long for multiple applications and may require trimming for your truck.

### Step 5:

Install over the axle pipe and tailpipe placing metal hangers into OE rubber mounts. NOTE: Your tailpipe is made long for multiple applications and may require trimming for your truck.

---

**Step 6:**

Measure the gap between the muffler and the mid pipe. This will tell you how much of the extension pipe is needed. Trimming of the extension pipe may be required for a perfect fit. Install the extension pipe as required. With the pipes mounted loosely, adjust the new system for clearance and appearance. Evenly tighten all clamps starting with the front flange connection working your way to the back.