

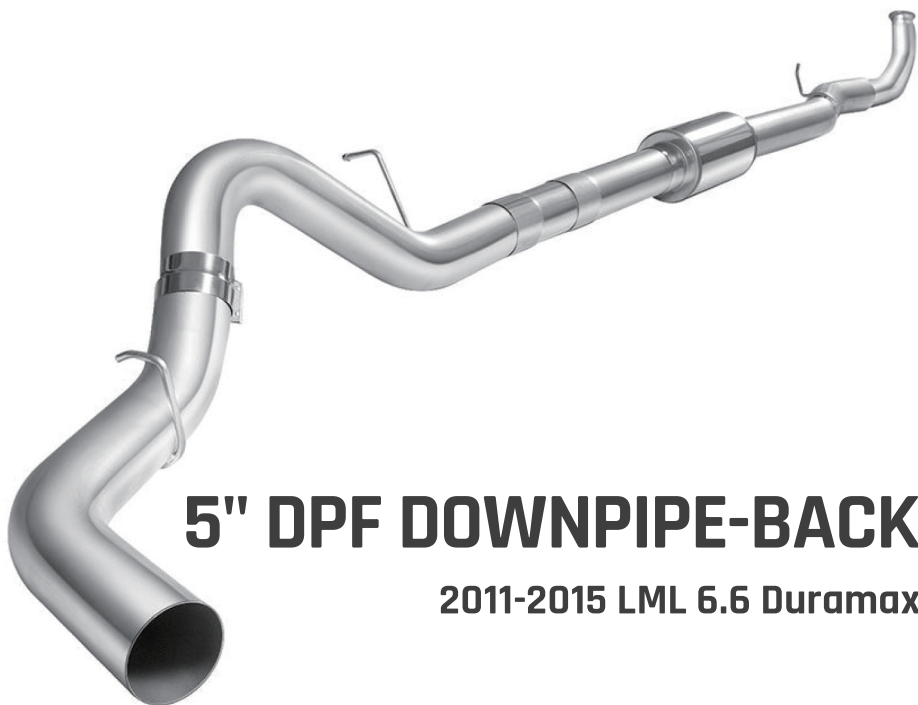





SPELAB



5" DPF DOWNPIPE-BACK

2011-2015 LML 6.6 Duramax

-  Spelab Racing
-  YouTube-SPELAB
-  service@spelabautoparts.com
-  www.spelabautoparts.com



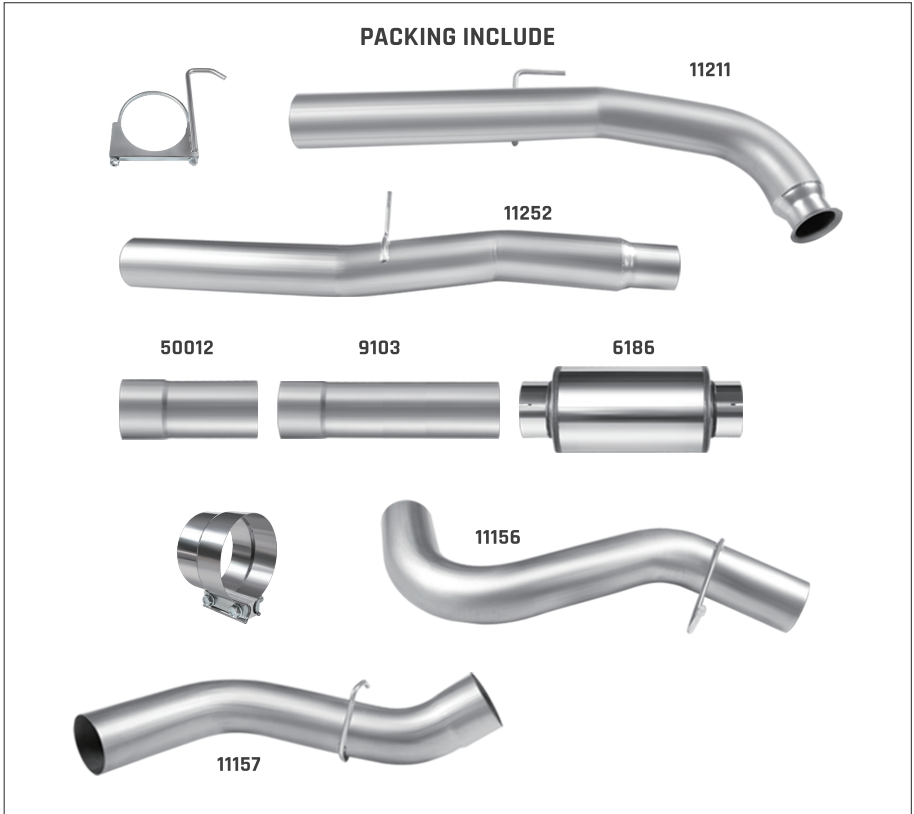

WARNING

Before you begin, verify that you received the right kit & each part listed is correct and in good condition.

Note: Always practice safe working standards using appropriate stands or having a second person on hand to help and allow for exhaust to completely cool before starting your.

INSTALLATION NOTES

Note: Prior to installation, please compare the parts that you have received with the bill of materials listed above to ensure that you have all the necessary parts for installation.

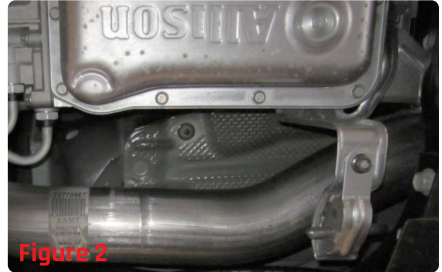
INSTALLATION STEPS**Figure 1****Figure 2**

Step 1: Unbolt the flanges fastening the downpipe and the DPF/tailpipe assembly. (See Figure 1)

Step 2: Remove all factory bungs and airlines on Diesel Particulate Filter, tie-strap them to the frame of the truck or take them off at the clip connection.

Step 3: Spray the hangers with WD-40 and then pry hangers from the rubber mounts and remove the DPF from truck.

Step 4: Remove the band clamp from the down pipe at the turbo. Loosen the bolt enough to unlatch the clamp, then pry the clamp away from the flange at three spots with a flat-headed screwdriver. Remove clamp. (Note: keep the stock band clamp, as it will be used with the new system).

Step 5: For easier removal of downpipe take the hanger bracket off bolted to the transmission, and cut pipe in half. (See Figure 2)

Notes: Make sure to put clamps on connections before connecting pipes.

**Figure 3****Figure 4**

Step 6: Put the metal hanger on the downpipe (part #11211) into the upper hole of the rubber insulator of the hanger bracket removed in step 5 above. (See Figure 3)

Step 7: Install the downpipe using the factory turbo band clamp. Snug the clamp down so it will hold the pipe but the pipe can still be moved. Bolt the hanger bracket back onto the transmission. (See Figure 3)

Step 8: Install pipe #11252 (See Figure 4) and extensions as needed depending on wheelbase length.



Step 9: Install muffler, clamp hanger (See Figure 5), over the axle pipe and tailpipe section inserting metal hangers on rubber insulators. (See Figure 6)

Step 10: Starting with pipe #11211, tighten turbo band clamp and work your way to the back connection, tightening as you go and checking for clearance.



Technical Support: email us service@spelabautoparts.com
www.spelabautoparts.com