

# Powered iPad Swivel Stand

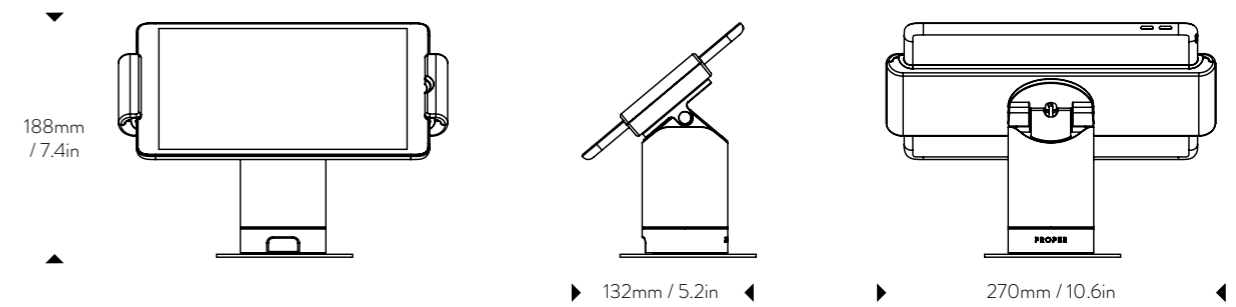





Built for business and designed with user experience in mind, the Swivel Stand encourages streamlined customer experiences and simplified interaction.



## MEASUREMENTS



## FEATURES

-  Embedded MFi Power to stay connected at all times.
-  One-time permanent installation keeps the iPad safely and securely in place.
-  Easily share the screen with 180° of swivel rotation allowing simplified customer interaction.
-  Ergonomically friendly with screen angle adjustment for all heights.
-  Positionable in either portrait or landscape orientations.
-  Compatible with iPad (6th Gen). Backwards compatible with iPad (5th Gen) and iPad Air 1.

## PRODUCT SPECIFICATIONS

Product	Compatibility	Colour	SKU	Barcode	MSRP (AUD / USD)
iPad Swivel Stand	iPad 9.7"	Silver	SPEIPASSK61	706502065997	\$299 / \$340

