

OPERATION MANUAL

MBM 508A

AUTOMATIC FOLDER



MBM
CORPORATION

1-800-223-2508

WWW.WHITAKERBROTHERS.COM
3 TAFT COURT
ROCKVILLE, MD 20850
800-243-9226

Rev. 1.01

Safety Instructions

Definition of Symbols and Notes

In this manual following names and signs stand for possible dangers.



Danger

This Symbol stands for immediate danger threatening the life and health of persons. Disregarding these instructions may cause severe damage to health and even serious injuries.



Caution

This symbol stands for an endangering situation that may occur. Disregarding these instructions may lead to slight injuries or damage to property.

Danger	
	Make sure that the machine is electrically grounded. This prevents an electric shock when there is a leak of electricity.
	Use the machine at 230VAC with a frequency of 50/60Hz. A fire may start or the machine may break down if a higher or lower voltage is used, or if an electric current with a frequency that is not within the range of frequency stated above.
	Do not place any object on this machine. A fire may start or electricity may leak if water or a foreign object enters inside the machine.
	Handle the power cable with care. A fire may start or an electric shock may be caused if the cable is damaged, broken, or processed, if a heavy object is placed on the cable, or if the cable is bent forcibly.
	Do not pull the power plug out of or put it in the electric outlet using a wet hand. Otherwise, an electric shock may be caused.
	Do not remove the cover of this machine. Otherwise, an electric shock or injury may be caused.
	Do not remodel this machine. Otherwise, a fire may break out or an electric shock may be caused.
	If the machine is used when it is in an abnormal condition, such as generating heat, emitting smoke, and giving out a strange smell, a fire may break out or an electric shock may be caused. Turn off the power switch immediately and then pull the power plug out of the electric outlet. Afterward, consult with your dealer.
	If abnormalities such as the power cable generating heat and giving out a strange smell are found, turn off the power switch immediately and then pull the power plug out of the electric outlet. Afterward, consult your dealer.
	If a foreign object enters into the machine, turn off the power switch first and then pull the power plug out of the electric outlet. Afterward, consult your dealer.
If thunder approaches, pull the power cable out of the electric outlet to prevent a fire or breakdown caused by the falling of a thunderbolt.	

Caution

	Do not let hairs, a necktie, or necklace hang above the drive of the machine. Doing so may cause an injury.
	Do not put the machine on an unstable place such as a shaky stand and a slant floor. Doing so may cause the machine to drop or fall down, causing an injury.
	Do not put the machine in a moist or dusty place. Doing so may start a fire or cause an electric shock.
	Be sure to pull out the power cable while holding the plug. If the power plug is pulled out while holding the cable, a fire may break out or an electric shock may be caused.
	Be sure to pull the power plug out of the electric outlet first when moving this machine. Otherwise, the cable may be damaged, causing a fire or an electric shock.
	Be sure to pull the power plug out of the electric outlet for safety purposes when this machine is not in use for prolonged period such as consecutive holidays or for other reasons.

Warning

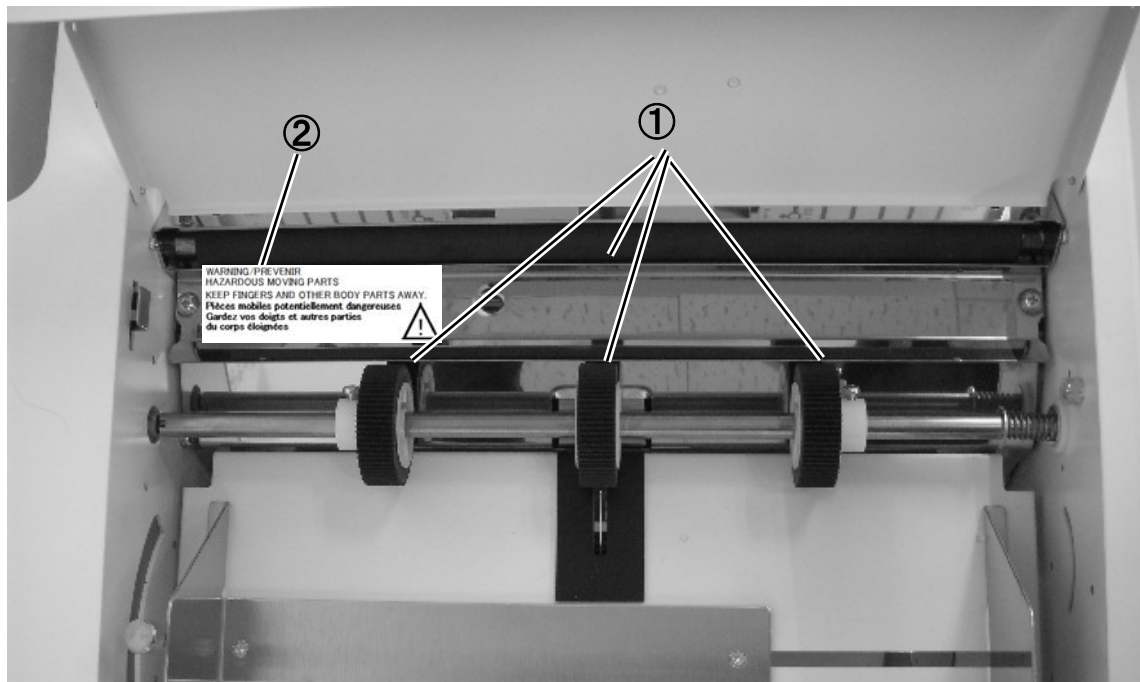

- ① Moving Parts
- ② Warning Label

**WARNING/PREVENIR
HAZARDOUS MOVING PARTS
KEEP FINGERS AND OTHER BODY PARTS AWAY.
Pièces mobiles potentiellement dangereuses
Gardez vos doigts et autres parties
du corps éloignées**



Introduction

Please read this Operation Manual carefully before using this machine. Store the Operation Manual in a safe place so that it can be easily retrieved and referred to whenever required.

Since the specifications of this product are subject to change for the purpose of further improvement, the descriptions in the Operation Manual may be different from unit to unit even for the same model. Be sure not to refer this manual for one of a different model. Use this manual only for originally delivered model. Some components are omitted in the illustrations in this manual.

Content

1. Precautions on Installation

1-1 Installation location	7
1-2 Precautions in moving in	7
1-3 Check the content and quantity of accessories	8

2. Part Name

2-1 Appearance	9
2.2 Control panel	10

3. Matters That Require Particular Attention

3-1 Definition of terms	
3-1-1 Explanation of mark	10
3-1-2 Term/Fold type description	10
3-2 Characteristics and intended purpose of use	11
3-3 When not in use	11
3-4 Precautions for use	11

4. Preparation

12

5. How to Use

5-1 Standard Folding of Standard-size Paper	14
5-2 To manually input paper length	16
5-3 Non-standard Folding	18
5-4 Cross Folding	20
5-5 How to fold art paper/coated paper	
5-5-1 Replace with the separator for coated paper	21
5-5-2 Pressure adjustment for paper feed and paper separator	22
5-6 Adjustment	
5-6-1 Slant adjustment	23
5-6-2 Fine adjustment of fold position	24
5-6-3 Adjustment of paper ejection roller position	27
5-7 Memorization/deletion of fold position of standard-size paper	
5-7-1 Memorization of finely-adjusted fold position	28
5-7-2 Deletion of individual memory of fine adjustment	29

5-8	Memorization/deletion of fold position of non-standard fold and non-standard-size paper	
5-8-1	Memorization of fold position	30
5-8-2	Calling up fold pattern memory	31
5-8-3	Deletion of entire fold pattern memory.....	32
5-9	Counter setting	
5-9-1	Addition mode	33
5-9-2	Subtraction mode	34
5-9-3	Interval mode	35
5-10	Speed adjustment	36
5-11	Double feed detection function	
5-11-1	What is double feed detection	37
5-11-2	Activation of double feed detection	37
5-11-3	Use of double feed detection.....	38
5-11-4	When the machine stops based on double feed detection error (E-52).....	38
6.	Maintenance Service, Inspection, Expendables	
6-1	Cautions for maintenance service and inspection	39
6-2	Usual maintenance service	39
6-3	Expendable supplies	39
6-4	Removal and installation, and cleaning of folder roller	40
6-5	Cleaning of the paper feed, double feed detection, paper ejection photo sensors	41
6-6	Removal and installation of paper separator, paper feed rubber roller, brake rubber	42
7.	Trouble shooting and correction	
7-1	Error display	
7-1-1	Error display screen	43
7-1-2	List of Error Codes.....	44
7-2	Troubleshooting	45
8.	Relocation or Disposal	
8-1	Relocation	
8-1-1	Removal of the machine from its present location	47
8-1-2	Transport	47
8-1-3	Installation.....	47
8-2	Disposal	47
9.	Specifications	48

1. Precautions on Installation

1-1 : Installation location

Install this product where the following conditions can be fulfilled.

- Do not install it in a place exposed to direct sunlight.
- Avoid a location near a window.
- Do not install it in a dusty place or a place of high humidity.
- Do not install it in a place exposed to a direct wind or a location near a heating equipment.
- Install it on a sturdy and horizontally-located flat stand or table.

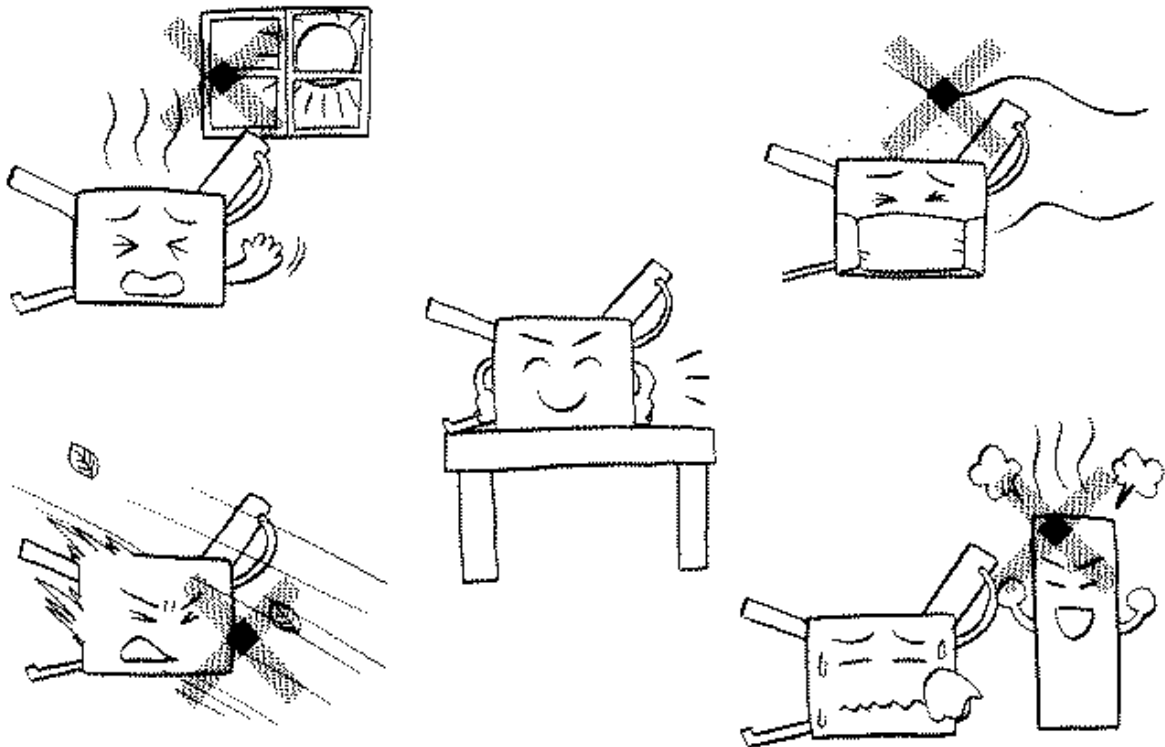

1-2 : Precautions in moving in





- Handle with care and do not subject the unit to shock or strong vibration.
- Ensure that the machine is carried by two persons wearing protective gloves, holding the four corners of the base firmly.

1-3 : Check the content and quantity of accessories

Check accessories immediately upon unpacking.

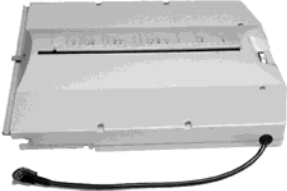
Should there be anything short, contact your distributor.

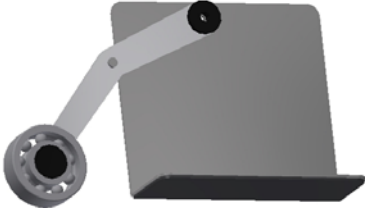
Also, fill out the warranty documents.

Accessories	Qty	Illustration
Folding Table 1	1	
Folding Table 2	1	
Power cable	1	
Auxiliary paper guide (right and left)	One(1) each	
Operation Manual	1	
Handy Manual (1 page/A3 size)	1	

2. Part Name

2-1 : Appearance

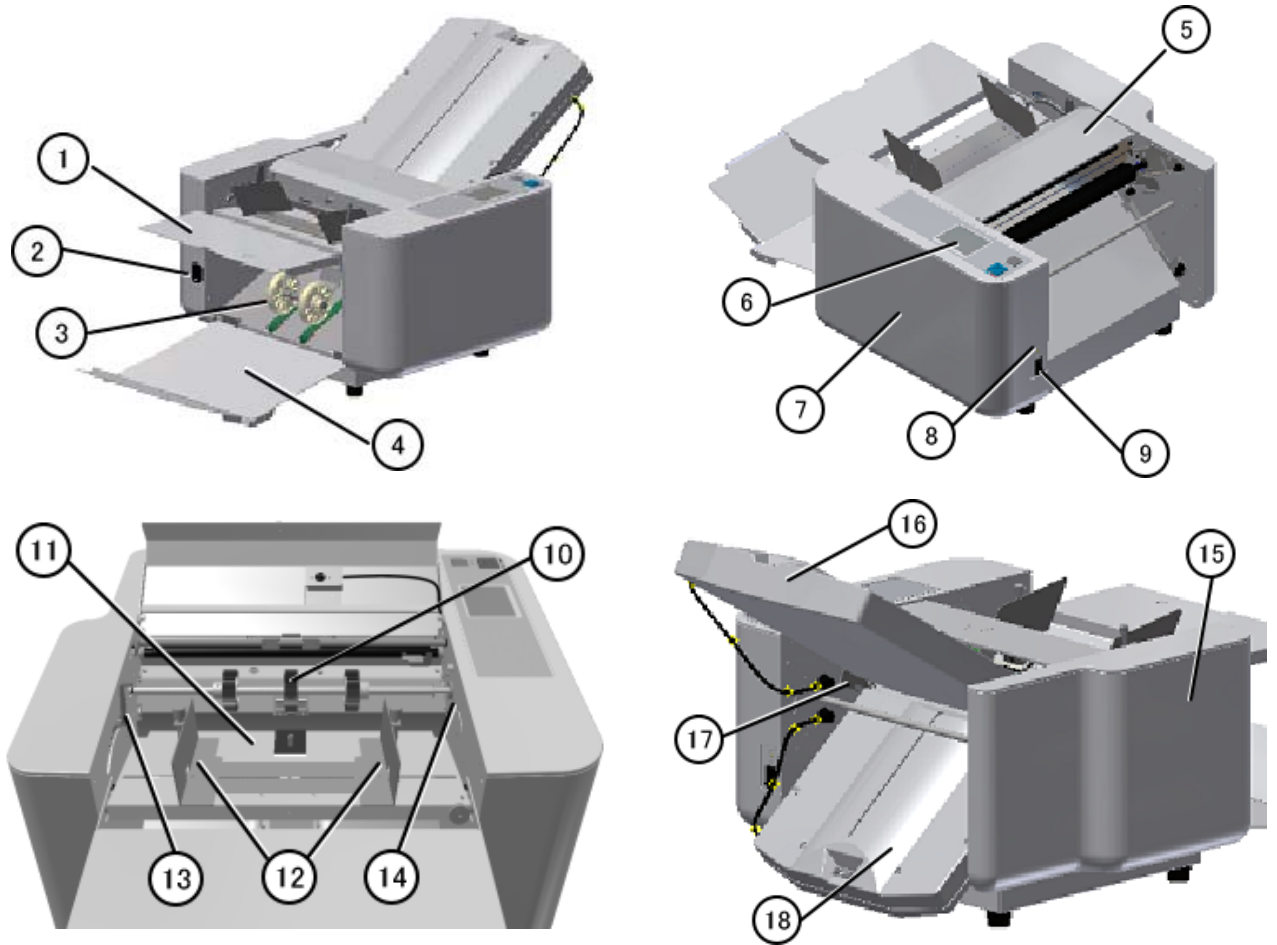

No.	Name	Function	No.	Name	Function
1	Auxiliary table	For supporting larger paper	11	Paper feed table	For loading paper
2	Inlet	For connecting the power cable	12	Paper guide	For prevent slant paper feeding
3	Paper ejection roller	Arranges and ejects folded paper	13	Paper feed pressure lever	For adjusting paper feed pressure
4	Paper ejection table	For stacking folded paper	14	Separator pressure lever	For adjusting separator pressure level
5	Safety cover	The machine stops when this cover is opened.	15	Left side cover	For protecting mechanical parts
6	Control panel	For setting operation of machine	16	Folding table 1	For performing the first fold
7	Right side cover	For protecting against mechanical/electrical parts	17	Folder roller setting lever	For removing and setting the folder roller
8	Breaker	For protecting against overcurrent	18	Folding table 2	For performing the second fold
9	Power switch	For turning on/off the power			
10	Paper feed roller	Feeds one sheet of paper			

2-2 : Control panel

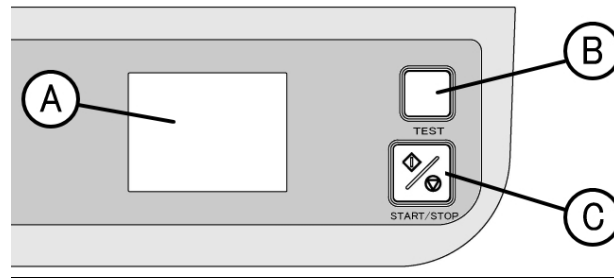

Number	Name	Function
A	Color LCD Touch panel	To enter operation command and display
B	“TEST” key	To perform test folding (two sheet without count)
C	“START/STOP” key	To start and stop the machine

3. Matters That Require Particular Attention

3-1 : Definition of terms

3-1-1 : Explanation of mark

Caution ! Matters that require attention

Hint ! Matters that are good to know

3-1-2 : Term/Fold type description

Term	Description
Jam	Paper is stuck inside the machine.
Double feed	Two or more sheets of paper are fed together.
Slip	Paper is not fed due to slippage.
Fan out	Separate stuck sheets of paper by letting air in between them

Chart						
Fold type	Single fold	Double parallel fold	Fold-out fold	Letter fold	Zigzag fold	Gate fold

The shaded parts in the illustrations show the upper side of the paper placed on the paper feed table.

3-2 : Characteristics and intended purpose of use

- Easy-to-read LCD color touch panel.
- High-speed paper folding.
- Automatic paper size detection, fold position setting, paper feed table adjustment (up-down), and paper ejection roller movement.
- For non-standard-paper or non-standard-fold, simply input paper length and fold type to automatically calculate fold position – no time-consuming manual calculation required.
- Memorizes up to 20 non-standard fold patterns.
Three parameters – fold position, speed, and paper ejection roller position – can be memorized.
- Interval mode
- Double feed detection function
- Cross folding

3-3 : When not in use

- Remove the power plug from the power outlet.
- Place the machine cover over the machine.

3-4 : Precautions for use

- Hold the center of the roller cover when opening or closing to prevent any danger of getting caught in the roller.
- Always conduct a test folding to check the fold position for particularly important documents.
- Regardless of the reasons, we will not be responsible or liable for folding misalignment and damage.

4. Preparation

1. Install fold table 1 and 2 at the machine.

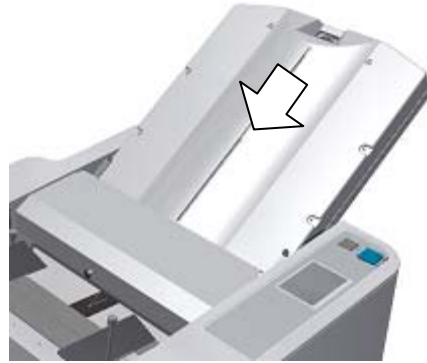

2. Insert the plug into the connector.



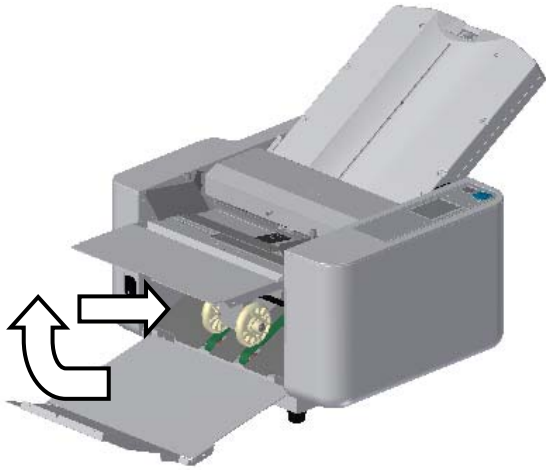

Pull out and extend the paper ejection table.
Then, lift up and set flat the auxiliary table.



Insert the power cable into the outlet.
(The shape of plug may differ from the one shown
in the illustration.)

Caution!

Be sure to unwind folded power cable before use.
Do not use any power cable other than provided as an accessory.
Be sure to ground the earth wire of the power cable.



When the power switch is on, the touch panel lights and the machine is ready to operation.

	Danger
	Do not insert or remove the power plug with a wet hand. It may cause an electric shock.
	Do not insert the ground (earth) wire of the power cable into the outlet or bring it into contact with the outlet. It may cause a fire or electric shock.

5. How to Use

5-1 : Standard Folding of Standard-size Paper

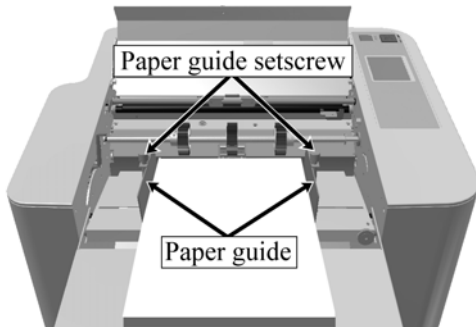

- [1] Set the standard –size-paper.
- [2] Loosen the paper guide setscrew and set the paper guide to fit the width of the paper.
- [3] Stack the paper on the paper feed table after neatly arranging it.
- [4] Make the paper guide closely contact the paper and tighten the paper guide setscrew.

Caution!

Be sure to ensure that ink has dried completely on printed materials. In case of immediately after printed documents, they may cause jamming, double feeding, paper slippage or wrinkles.

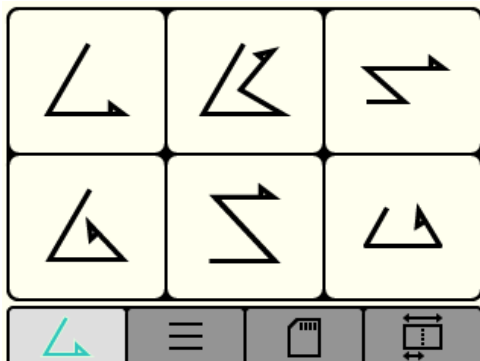

- [5] Select the fold type.
Select from among the six fold types (Single, Double, parallel, Fold-out, Letter, Zigzag, Gate).
Press the desired fold type key.

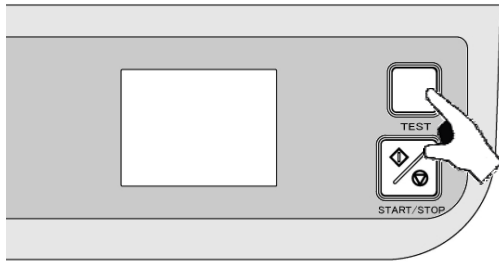

[7] Test folding

Press the “TEST” key, and one sheet will be folded.
 (The counter display will remain to display [0].)
 Check the folding result with the folded paper.

Hint!

<Causes of folding misalignment>

- Stains on the roller
- The paper guide is set askew, or it is not in close contact with the paper.
- The paper feed table is set askew.
- The paper is cut at a slant.

<To correct folding misalignment>

→ Refer to “5 - 6 Adjustment” on pages 23 to 27.

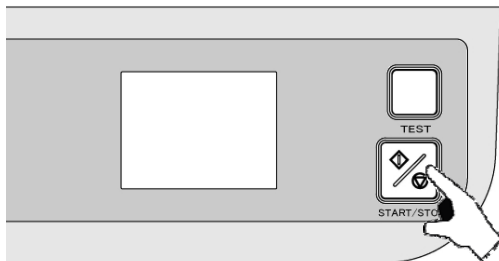

[8] Continuous folding

Press the “START/STOP” key, and the paper feed table will move up and the machine will continuously fold the paper.

When the “START/STOP” key is pressed while the machine is in operation, the machine will stop the operation, but the addition on the counter will continue.

If you wish to fold only the number of sheets desired, refer to “5-9-2 Subtraction Mode” on page 34.

If paper is not ejected smoothly, refer to “5-6-3 Adjustment of Paper Ejection Roller Position” on page 27.

5-2 : To manually input paper length

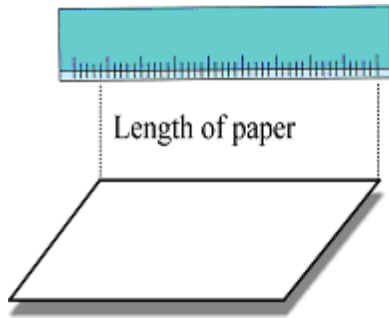

[1] Measure the length of paper in the direction of feeding paper.

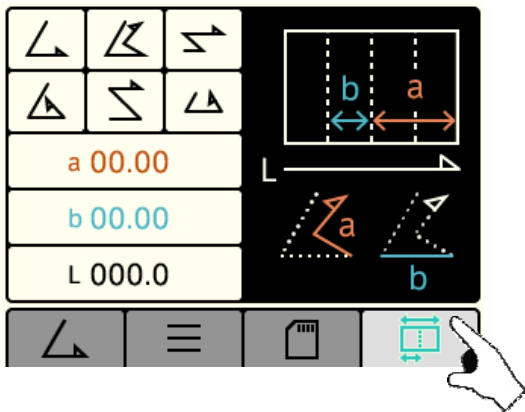

[2] Press the “Non-standard Fold” key

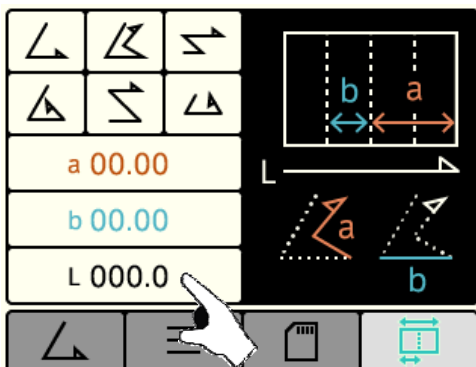

[3] Press the “Input Paper Length” key.

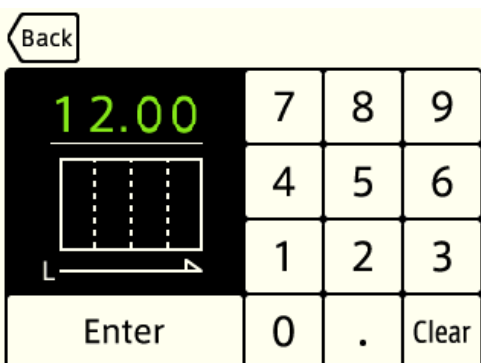

[4] Input the length of paper using numerical keys and press the “Enter” key.

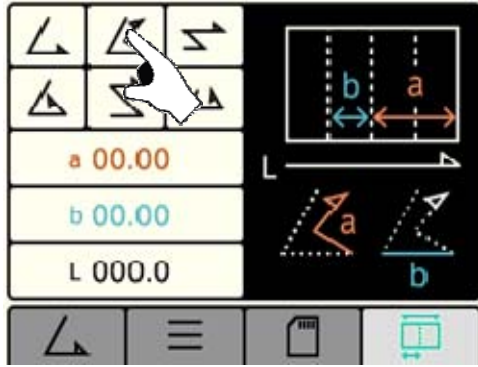

[5] Select the desired fold type from among the **six fold ty** keys.

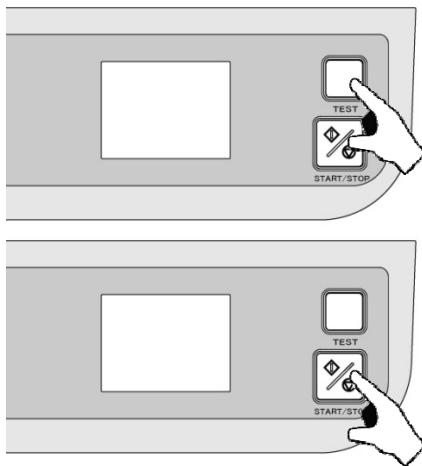

[6] Press the “TEST” key to perform test folding.

If test folding is satisfactory, proceed to step [7].

If it is not satisfactory, adjust folding misalignment.

=> Refer to “5.6 Adjustment” on pages 23 to 27.

[7] Press the “START/STOP” key to start continuous folding.

5-3 : Non-standard Fold

- Automatic settings cannot be used for non-standard fold. Individual setting of paper size and specifications is required.
- It can be set for both standard-size paper and non-standard paper based on the following procedure.

[1] Using the standard-size or non-standard-size paper you want to fold, create a sample by folding the paper manually.

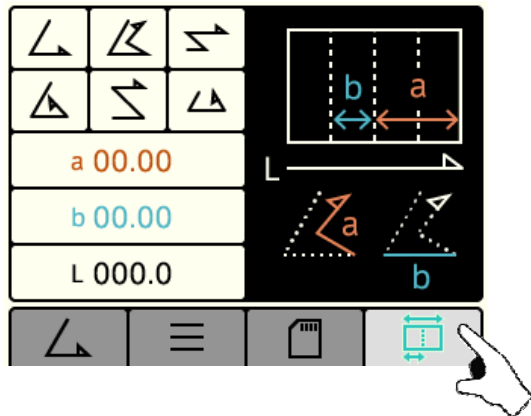

[2] Press the “Non-standard Fold” key

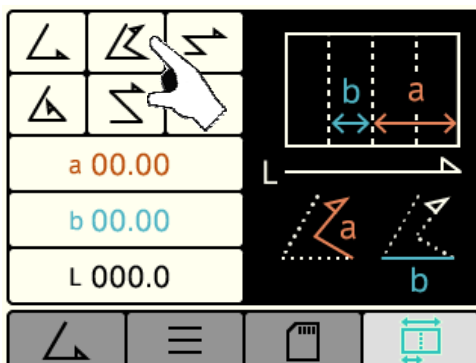

[3] Select the key of the fold type that is the nearest to the intended folding.

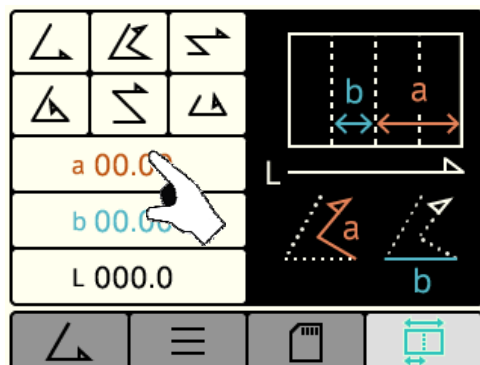

[4] Press the “a” key , and “b” key.

* In the case of single fold, there is no screen for inputting the length of “a” but only the length of “b” should be input.

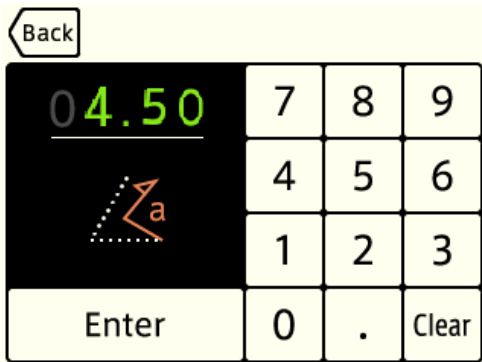

[5] Input the length of “a” using numerical keys and press the “Enter” key.

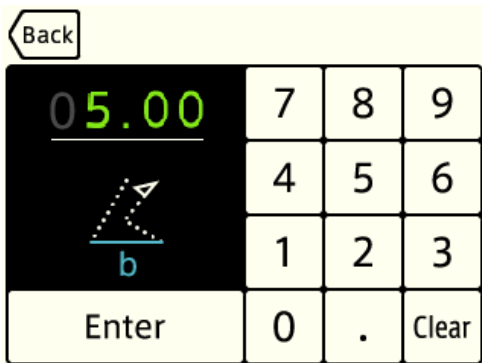

[6] Input the length of “b” using numerical keys and press the “Enter” button.

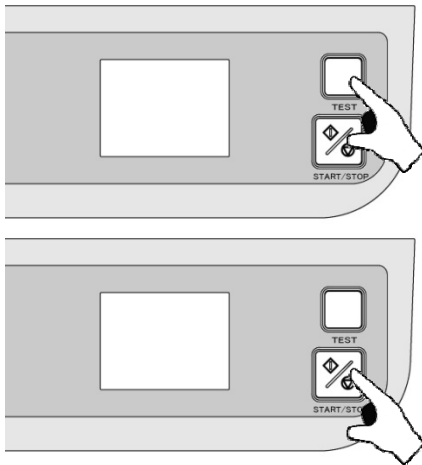

[7] Press the “TEST” key to perform test folding.

If test folding is satisfactory, proceed to step [8].

If it is not satisfactory, adjust folding misalignment.

= > Refer to “5.6 Adjustment” on pages 23 to 27.

[8] Press the “START/STOP” key to start continuous folding.

5-4 : Cross Folding

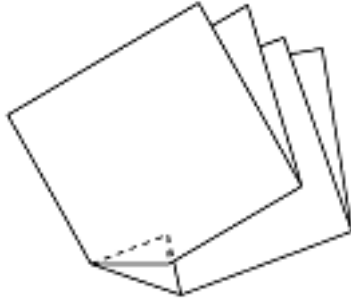
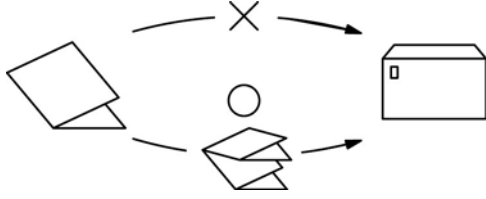

- Cross-folding is to further perform double parallel fold or letter fold on a sheet of paper folded already by single fold.
- This is good for folding A3 size stock which is already folded by double parallel fold but still will not fit into a standard size envelope.

* Paper that can be used for cross folding varies according to the conditions such as type of paper, paper size, paper with lateral grain, paper with vertical grain, temperature and humidity, printing conditions.

It may occur that lateral slanting is larger than normal folding or the corner of the crease is folded inward, but this is not caused by machine failure.

Caution!

Press along the single folded line of the paper with fingers.

The amount of paper loaded should be less than normal (30 sheets or fewer).

Auxiliary paper guides should be placed away from built-in paper guides, and the roller should hold down the single folded line by the first folding process.

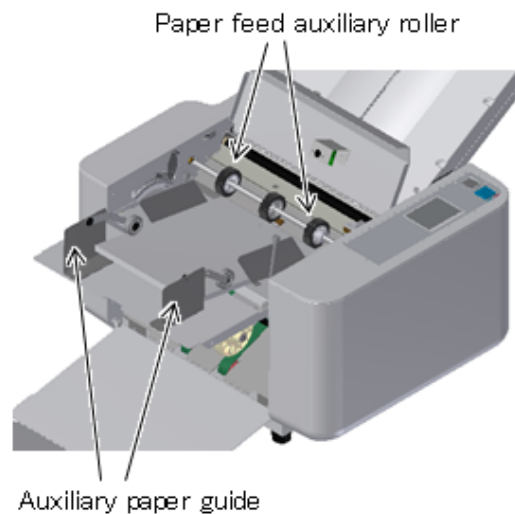

- (1) Load single-folded paper on the feed table and secure it with the built-in paper guides from both sides.
- (2) Slightly loosen the right and left screws of the paper feed auxiliary roller, and set them to where both ends of the paper are held down.
- (3) Set the right and left auxiliary paper guides where the bearing at the edge will accommodate the previously single folded paper edge.

Caution!

As the holder of the paper feed auxiliary roller is made of resin, take care not to damage the holder by tightening the screws too tightly.

5-5 : How to fold art paper/coated paper

5-5-1 : Replace with the separator for coated paper.

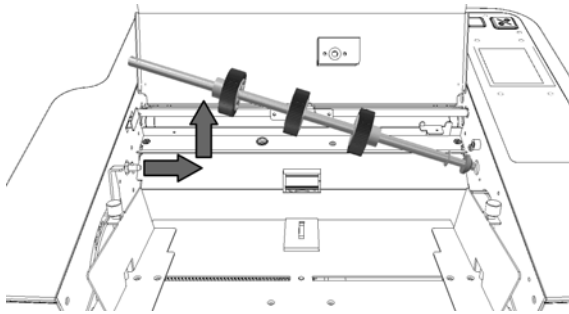

[1] Remove the paper feed roller shaft.

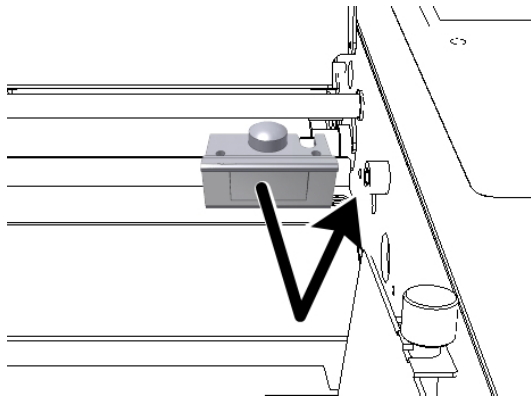

[2] Loosen the white knob screw and remove the special paper separator for the art paper/coated paper.

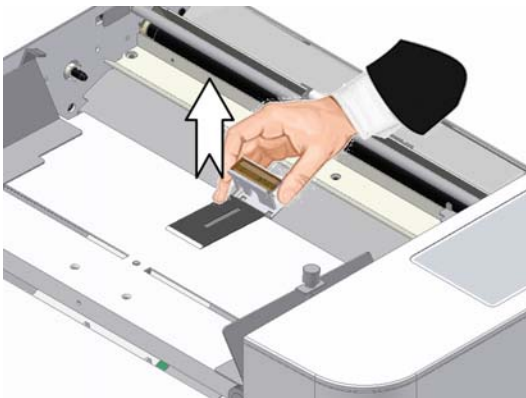

[3] Pull out the separator which is fitted as standard, and replace it with the special separator for coated paper.

The separator for coated paper has an indent in the center of its rubber part. Thus easily distinguishable from the standard separator.

Standard separator

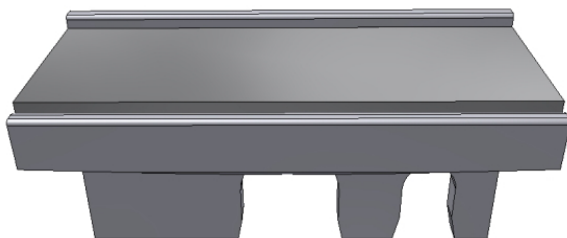

Special separator for coated paper

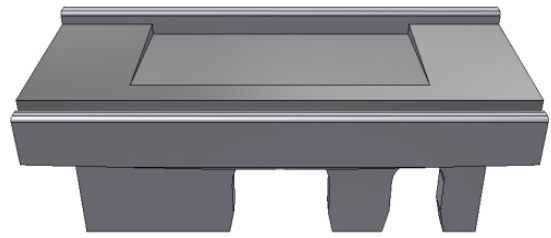

5-5-2 : Pressure adjustment

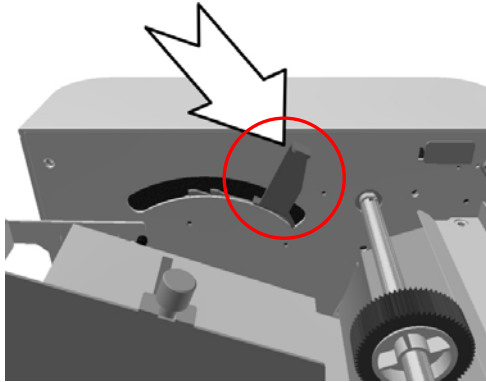

[1] Set the paper feed pressure adjustment lever at “0”

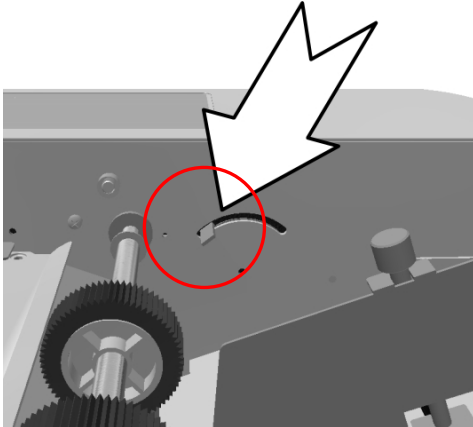

[2] Set the separator pressure adjustment lever at “2”.

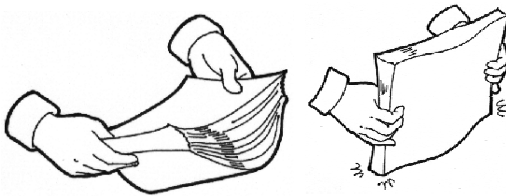

[3] Properly fan out the sheets of paper before loading them.

Fan out the sheets of paper, allowing air to come in between the sheets.

Caution!

In the case of printed art paper or coated paper, the degree of adhesion may be very strong, and paper feed errors are more likely to occur even after taking steps [2] and [3]. Therefore, be sure to fan out the sheets of paper sufficiently before setting the paper on the paper feed table.

Hint!

Fan out the sheets of paper a few times both vertically and horizontally. The paper will then be fed more smoothly.

If the volume of loaded paper is large, paper feed troubles are more likely to occur.

Both art paper and coated paper easily attract static electricity. If paper feed troubles frequently occur, remove tables 1 and 2, and spray anti-static spray near the edge where paper enters. It is recommended to spray frequently to remove static electricity.

< If double feed is frequently occur >

- Referring to the illustration on page 22, properly fan out the sheets of paper again.
- Ensure that the paper to be loaded on the paper feed table is no higher than 10 mm.
- Change the position of the separator pressure adjustment lever to “3” from “2”.
- The higher the setting of the separator pressure adjustment lever, the stronger the force of separating the sheets of paper.
- Lower the processing speed level by one.

Note: It is recommended that above adjustment is done at middle folding speed of 3. Then lower speed by one step at a time if necessary.

<If paper feed slip frequently occurs >

- Change the setting of the paper feed pressure adjustment lever from to “1” from “0”
- The higher the setting of the paper feed pressure adjustment lever, the stronger the force of feeding the paper.
- Increase the folding speed level by one.

Note: It is recommended that above adjustment is done at middle folding speed of 3. Then lower speed by one step at a time if necessary.

5-6 : Adjustment

5-6-1 : Slant adjustment

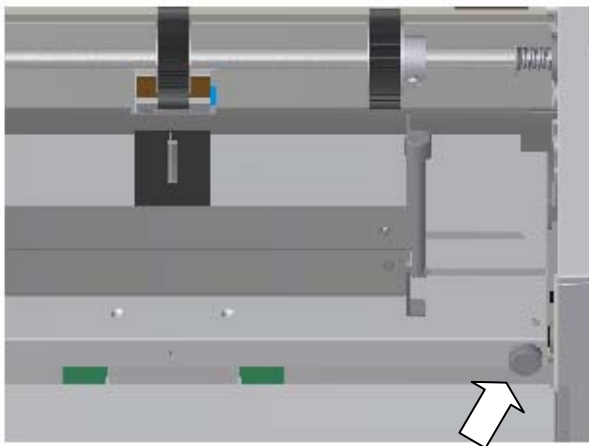

If the folding position is slanted because the paper is cut at a slant or for other reasons, it can be adjusted using the slant adjustment knob.

Turn the slant adjustment knob to the right direction 1, if the lower side of the folded paper slants to the right. Turn the knob to the left to the direction 2 if the lower side slants to the left.

(The basic position of the knob is the center where the pin is aligned with the slot.)

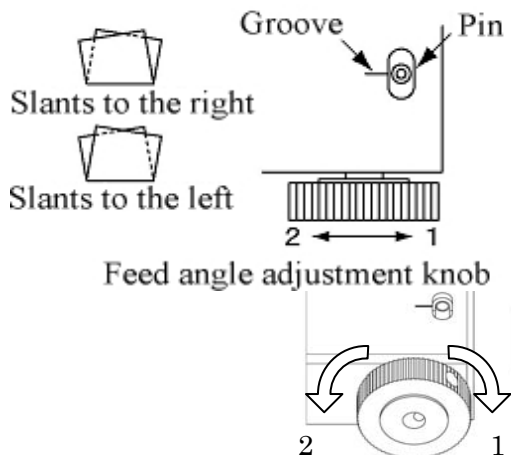

Caution !

Check if there is any space between the paper guides and the paper.

In cases other than single fold, put the folded paper at Table 1 face down to make a slant ejection adjustment.

If paper is reset at the paper feed table, start slant adjustment over again.

After specific job is completed, return the slant adjustment knob to its basic position, i.e., center in the slot.

5-6-2 : Fine adjustment of fold position

If by test folds any folding misalignment is found after standard folding or non-standard folding is set, fine adjustment of the fold position should be made according to the following procedure.



[1] In case of “a”

Press the “+/-“ key and move the stopper to the desired position.

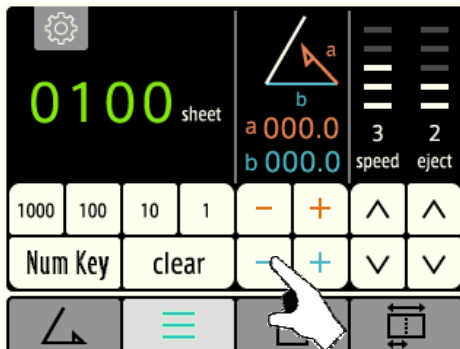

[2] In case of “b”

Press the “+/-“ key and move the stopper to the desired position.

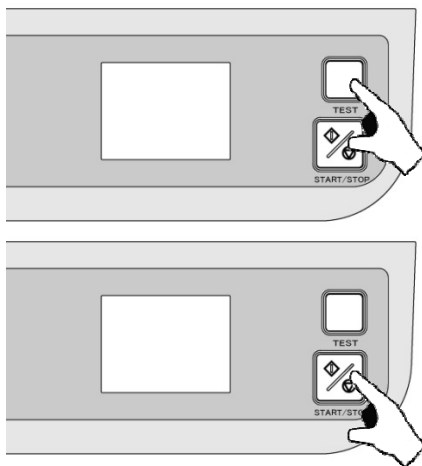

[3] Press the “TEST” key to perform test folding.

If test folding is satisfactory, proceed to step [6].

If it is not satisfactory, adjust folding misalignment.

When readjustment is required, repeat the above procedure [1] to [4].

[4] Press the “START/STOP” key to conduct continuous folding

Using fine adjustment knob







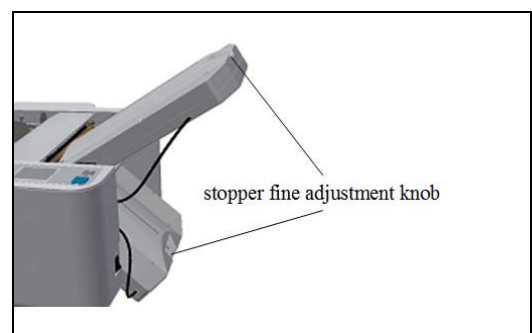



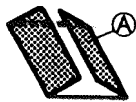



Move the stopper using the stopper fine adjustment knob.

Caution: (In case the stopper fine adjustment knob is moved)





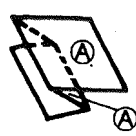





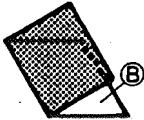

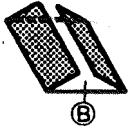

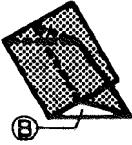
When the Test key is pressed, the machine will continue to fold, and when the Start/Stop key is pressed, the machine will start to fold after the stopper is returned to the previous position

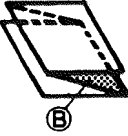

Fine Adjustment for Table 1

Fold type		Plane (A)	Direction to turn the Table 1 fine adjustment knob
Single folding	Table 1 is not used		
Gate folding		Long	
		Short	
Letter folding		Long	
		Short	
Zigzag folding		Long	
		Short	
Double parallel folding		Long	
		Short	
Fold-out folding		Long	
		Short	

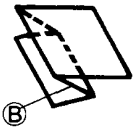
Fine Adjustment for Table 2

Fold type		Plane (B)	Direction to turn the Table 2 fine adjustment knob
Single folding		Long	
		Short	
Gate folding		Long	
		Short	
Letter folding		Long	
		Short	
Zigzag folding		Long	
		Short	
Double parallel folding		Long	
		Short	
Fold-out folding		Long	
		Short	

5-6-3 : Adjustment of paper ejection roller position

[1] Select the paper ejection roller position using “↑” and “↓” keys (5 levels).

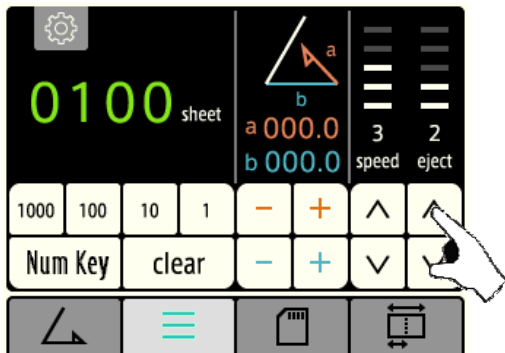

Hint !

For standard folding of standard-size paper, the paper ejection roller will be automatically set to the optimal position for the fold position, fold type and speed.

In the case of non-standard-size paper or non-standard fold, adjust the position of the paper ejection roller.

[Rough indication]

- For larger finished dimension Paper ejection roller => To the direction to 5
- For smaller finished dimension Paper ejection roller => To the direction to 1
- For higher processing speed Paper ejection roller => To the direction to 5
- For lower processing speed Paper ejection roller => To the direction to 1

5-7 : Memorization/deletion of fold position of STANDARD-SIZE-PAPER

In the case of standard folding of standard-size paper, after the fold position is finely adjusted, the fold position can be memorized.

5-7-1 : Memorization of finely-adjusted fold position

Complete adjustment in advance so that desired folding is performed.

[1] Press the “Gear” key.

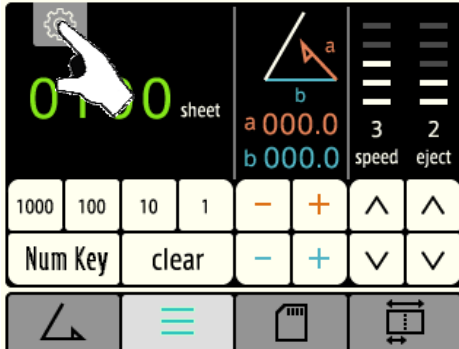

[2] Press the “Fold Pos. Adj. Memorize” key.

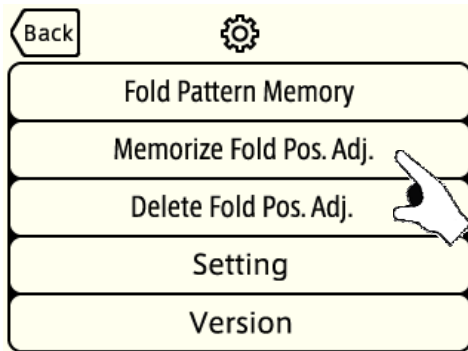

[3] Pressing the “YES” key, the finely-adjusted values will be memorized.

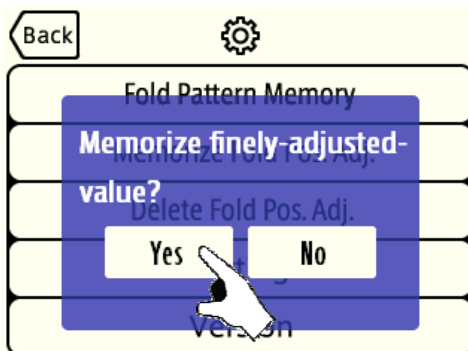

5-7-2 : Individual deletion of individual memory of fine adjustment

[1] Press the “Gear” key.

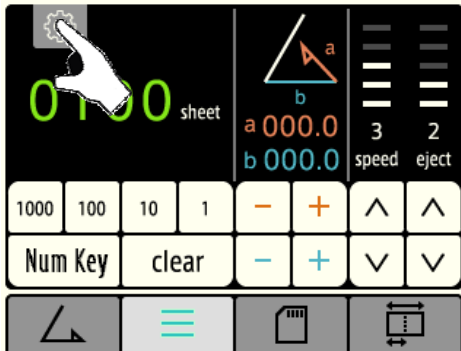

[2] Press the “Fold Pos. Adj. Delete ” key.

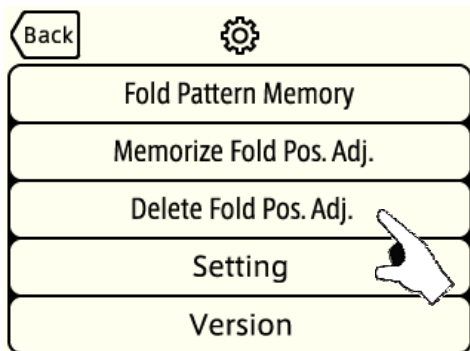

[3] Pressing the “Delete” key the finely-adjusted values will be deleted.

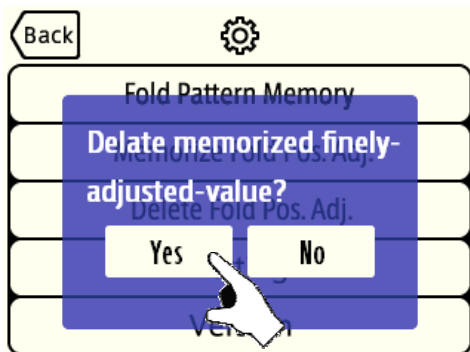

5-8 : Memorization/deletion of fold position of NON-STANDARD-FOLD and NON-STANDARD-SIZED PAPER

5-8-1 : Memorization of fold position

Complete in advance so that desired fold is performed.

[1] Press the “Gear” key.

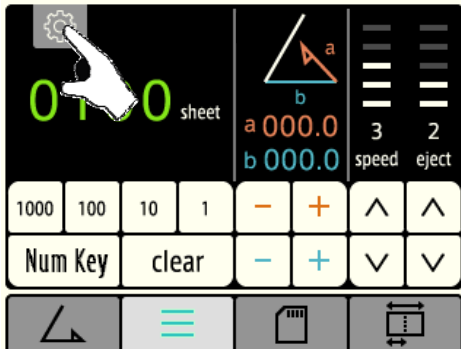

[2] Press the “Fold Pattern Memory” key.

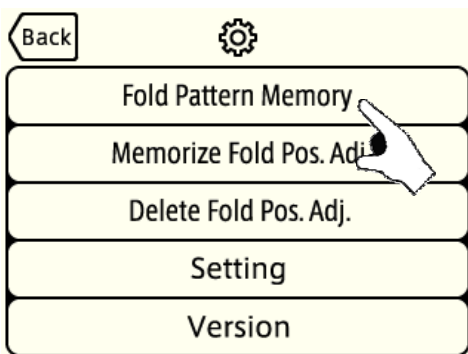

[3] Press the memory number window you want to memorize, and the present data will be memorized in the user memory.

Using “▲” and “▼”key, move the pages.

* As many as 24 pattern can be memorized.

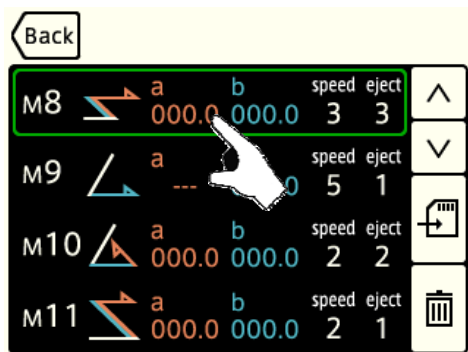

Keep pressing the “Memory” for three seconds, and all the fold pattern values will be memorized.

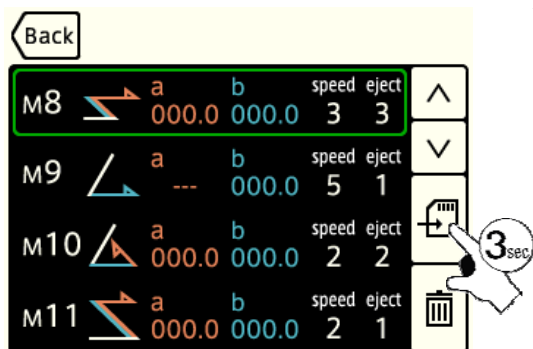

5-8-2 : Calling up fold pattern memory

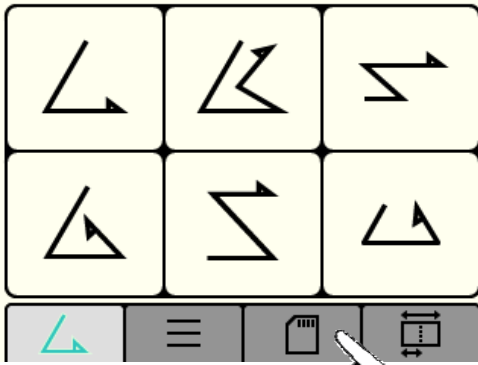

[1] Press the “Memory Fold” key .

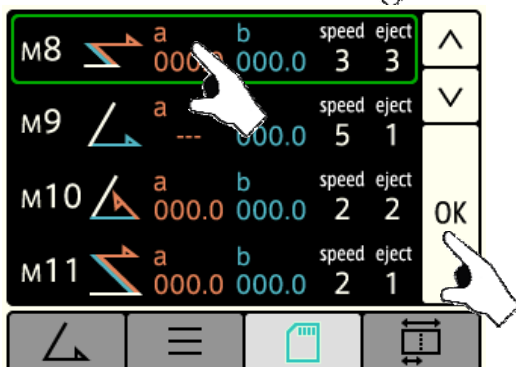

[2] Using “▲” and “▼”keys, select the memorized fold pattern and press the “OK” key.

Select desired memory number 01 thru 24 and press the window. Note, in case all factor are the same for paper size, folding pattern and speed, select by the register number.



[3]Once desired folding patten is retrieved, read and confirm that paper size, folding pattern, speed and register numbers are correct.

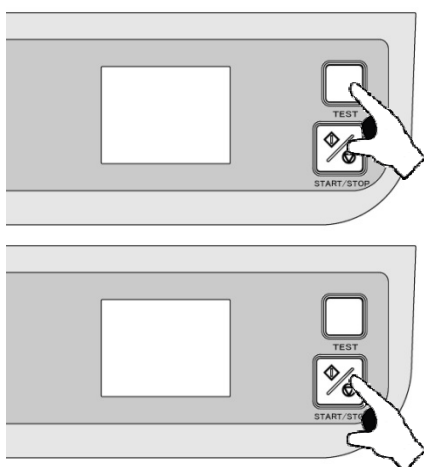

[4] Press the “TEST” key to perform test folding.

If test folding is satisfactory, proceed to step [5].

If it is not satisfactory, adjust folding misalignment.

When readjustment is required, repeat the above procedure [1] to [4].

[5] Press the “START/STOP” key to conduct continuous folding

5-8-3 : Deletion of fold pattern memory

[1] Press the “Gear” key.

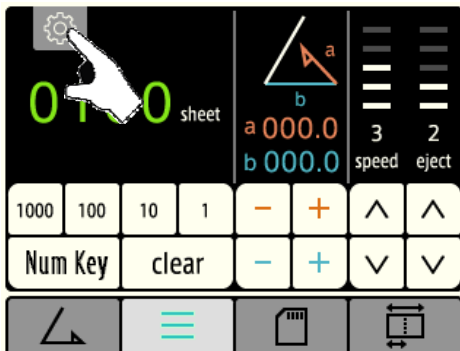

[2] Press the “Fold Pattern Memory” key.

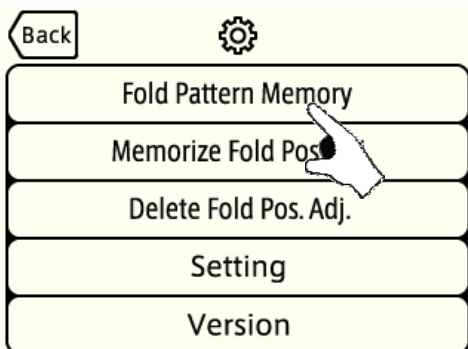

[3] Press the memory number window you want to memorize, and the present data will be memorized in the user memory.

Using “▲” and “▼”key, move the pages.

* As many as 24 pattern can be memorized.

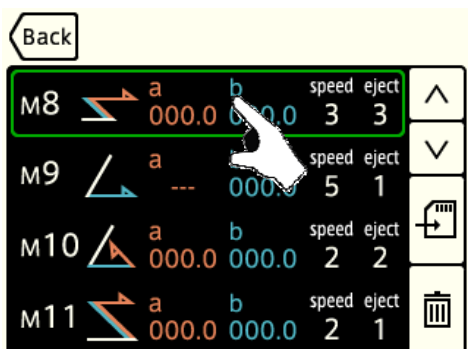

[4] Keep pressing the “Delete” for three seconds, and all the fold pattern values will be deleted.

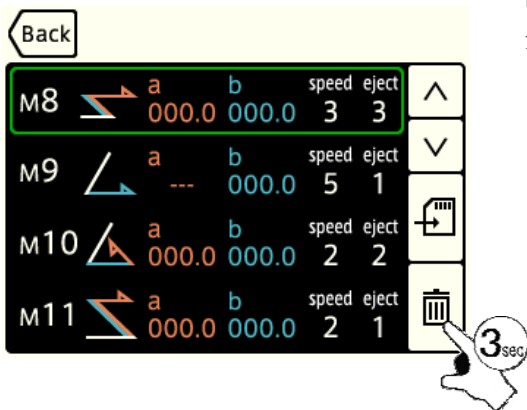

5-9 : Counter setting

5-9-1 : Addition mode

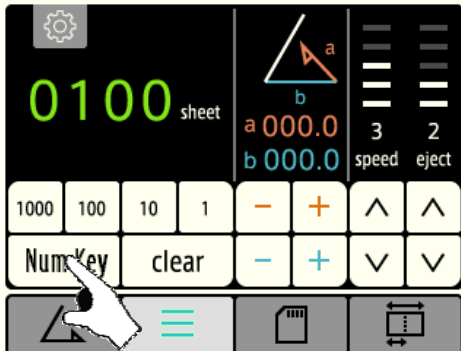

[1] Press the “Num Key” key

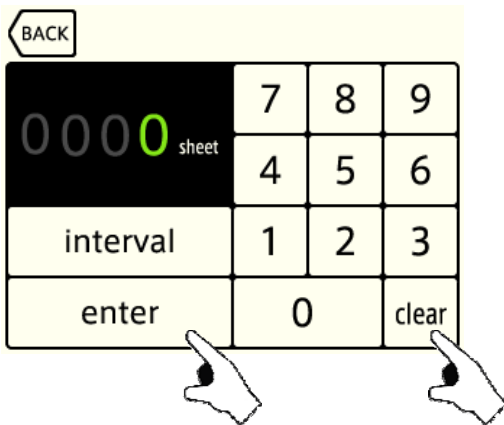

[2] Press the “clear” key to clear the counter, and press the “Enter” key.

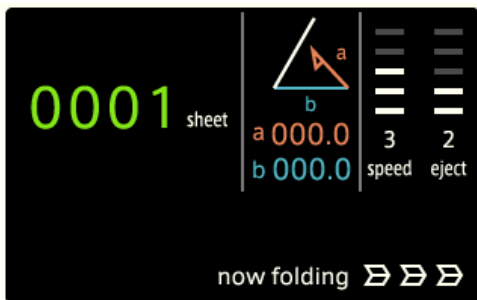

[3] When the Addition mode is selected, count only will be displayed on the counter display.

5-9-2 : Subtraction mode

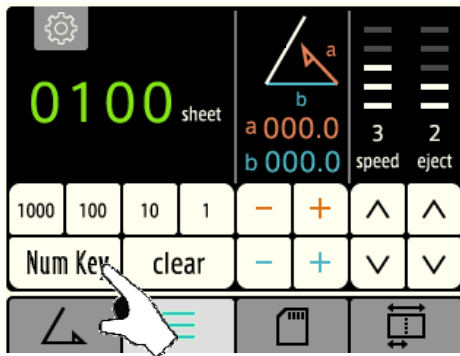

[1] Press the “Num Key” key

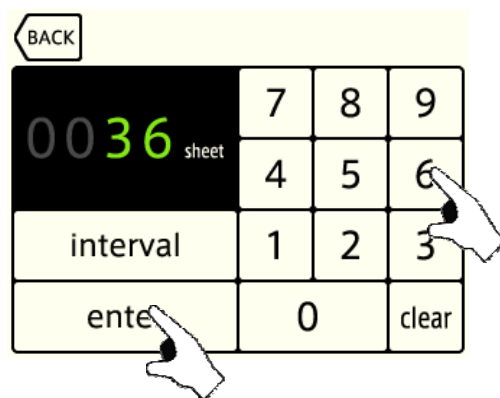

[2] Using numerical keys, input the number of sheets you want to fold in the counter and press the “Enter” key.

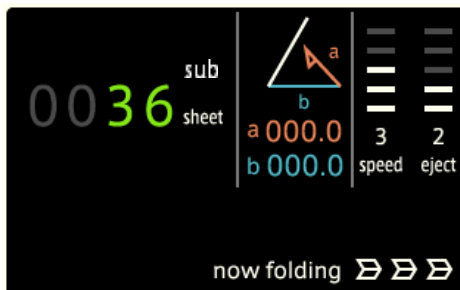

[3] While the Subtraction mode is activated, count and “SUB” will be displayed in the counter display.

5-9-3 : Interval mode

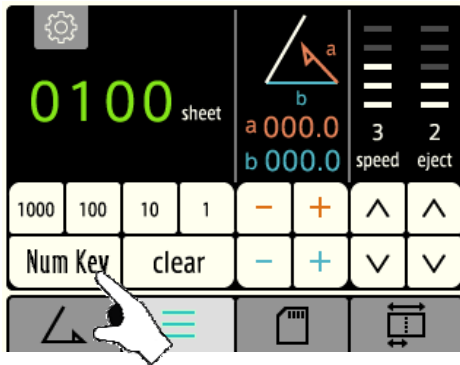

[1] Press the “Num Key” key

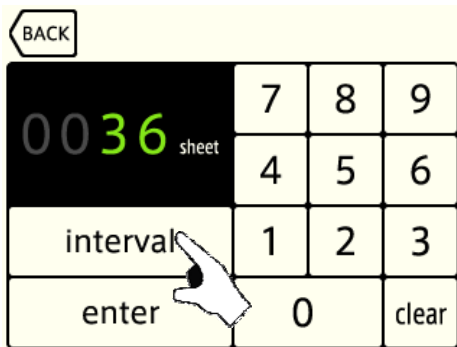

[2] Press the “Interval” key on the counter input screen, and the interval setting screen will be displayed.

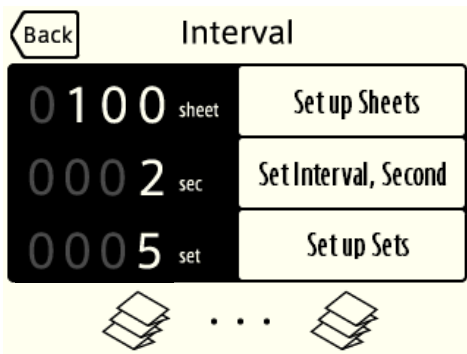

[3] Press the “Set up sheets” key. Input desired sheets quantity and press Enter.

By the same procedure, set up “Set Interval Second” and “Set up Sets”.

- When all the values are input, will be displayed again.

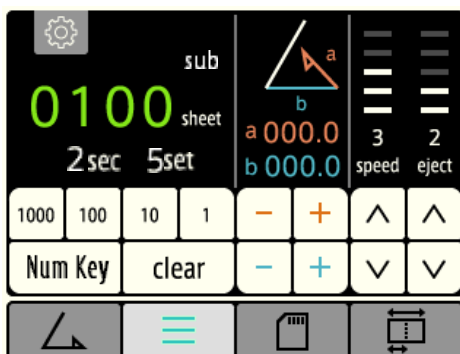

[4] When the Interval mode is activated, two values, namely, processed number of sheets and the number of sets will be displayed on the counter display.

5-10 : Speed adjustment

[1] Using “-” and “+” keys, set the speed (5 levels)

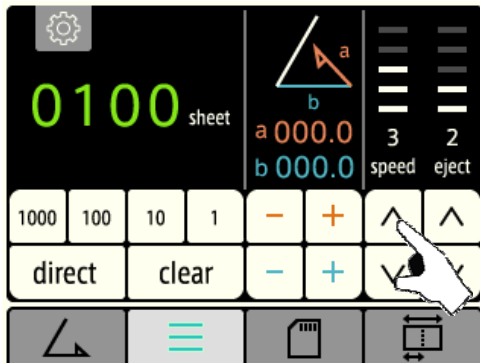

[2] Keep pressing the “speed” area for three seconds,
the machine enters SPECIAL mode.

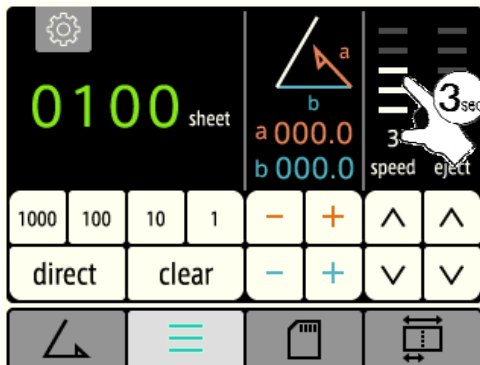

SP1: The machine operates in a silent manner. This mode
is not suitable for sheets of thick paper.

SP2: Dedicated mode for sheets of thick paper.

SP3: The machine can perform folding work at
high speed. Sheets of paper of A4 and smaller
sizes can be folded only in two, inward three,
and four.

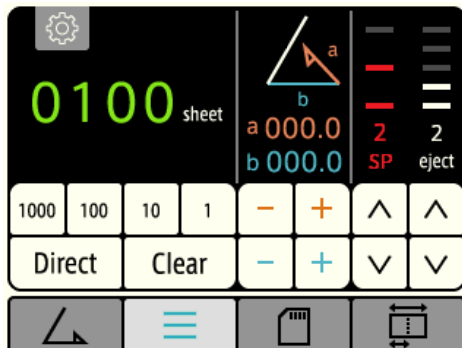

5-11 : Double feed detection function

5-11-1 : What is double feed detection?

Machine detects when two or more sheets are fed through together and the double-fed paper will be ejected on the folding table 1 which is located inside of rear cover without being folded.

* This function also detects differences in paper thickness and different print sheets, stopping the machine if such differences are detected. (Error Code E-52)

5-11-2 : Activation of double feed detection

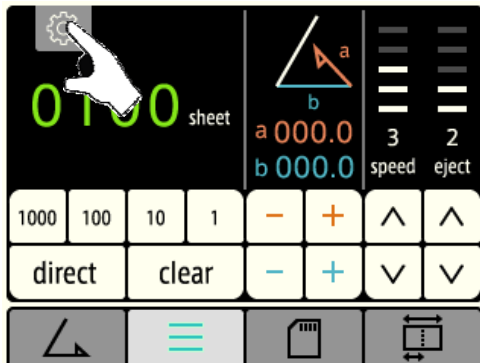

[1] Press the gear button and select the setting window.

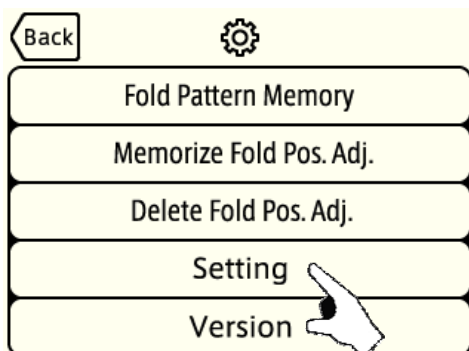

[2] Press the "Setting" key

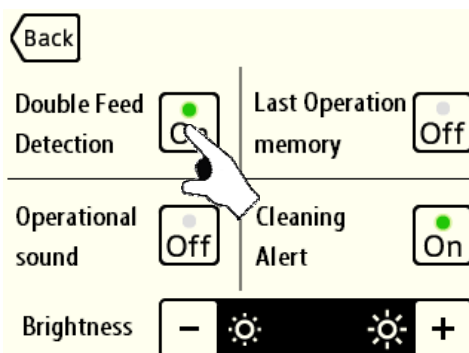

[3] Activating double feed function

Press the "Double Feed Detection" key to activate.

* When two or more sheets are fed together, or different prints are fed through, the machine will stop operating. (E-52)

[3] Canceling double feed detection function

Press the "Double Feed Detection" key to deactivate.

Cancel the double feed detection function in the situation such as:

* When performing cross folding

* When different prints, or paper of various thickness are being folded.

5-11-3 : Use of double feed detection

Notes: Make sure the double feed detection is activated.

It responds to all the fold types except cross folding.

[1] Perform test folding before starting actual operation.

* By the process of test fold, the machine memorizes paper thickness, print pattern, paper length. Based on the test fold data, it will detect double feed.

[2] Start folding operation as usual.

5-11-4 : When the machine stops based on double feed detection error (E-52)

[1] Open the rear cover and remove the paper ejected by double feed.

[2] Close the rear cover and press the error release button to release the error (E-52). Then, the machine will be able to restart its operation.

* Note: The paper will not be ejected automatically.

The double fed paper is not folded and held at Table 1 so that they can be reused.

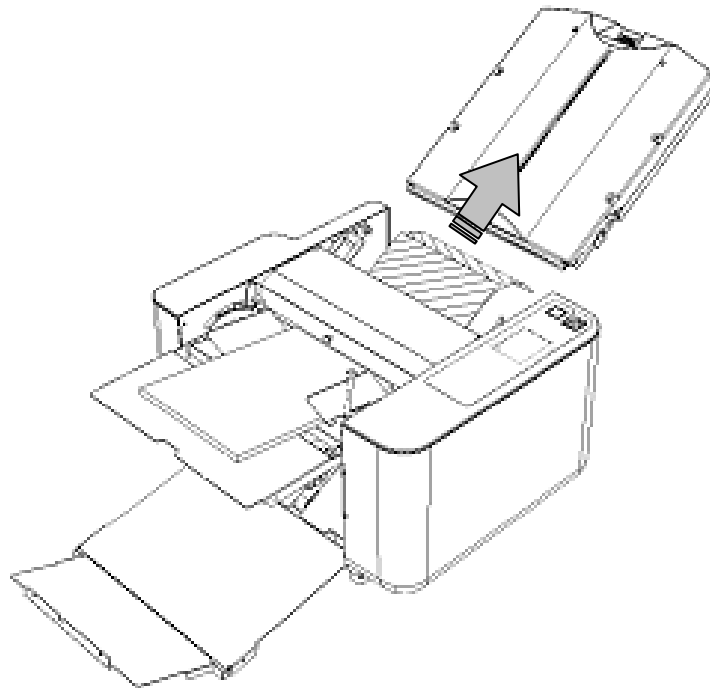

6. Maintenance Service, Inspection, Expendables

6-1 : Important points for maintenance service and inspection

6-2 : Usual maintenance service

Machine body

- If paper dust or dirt accumulates on the folding rollers, mechanical troubles may occur to the folding function. Therefore, place the machine cover over the machine when it is not in use.
- As for stains on the exterior parts, use dedicated cleaner.

Do not use solvent cleaning liquids as they may cause discoloration.

Folding roller

- If the folding rollers accumulate paper dust or ink from the printed material, it may make the paper wrinkled or cause troubles such as paper jam. To prevent this, clean the roller regularly using the dedicated cleaner and cloth.
- Using a cloth dampened with dedicated cleaner, strongly rub and wipe off the folding rollers one by one until the cloth no longer picks up any dirt.

Paper feed rubber roller

- If the paper feed rubber roller or the paper separator acquires paper dust or ink from the printed material, the paper folding function will deteriorate, and it may cause paper jam or slippage. To prevent this, clean them using the dedicated cleaner.

6-3 : Expendable supplies

The paper feed rubber rollers and paper separators are consumable products.

Contact your dealer when they need replacing.

	Warning
	When conducting inspections and maintenance service, be sure to remove the electric power plug from the outlet. If not, it may cause injuries or electric shock.

6-4 : Removal and installation, and cleaning of folder roller

Two rollers can be removed and installed without using any tool. Thus, cleaning of the rollers and paper ejection photo sensor can be done easily. As the other two rollers cannot be removed, they should be cleaned while manually revolving them little by little.

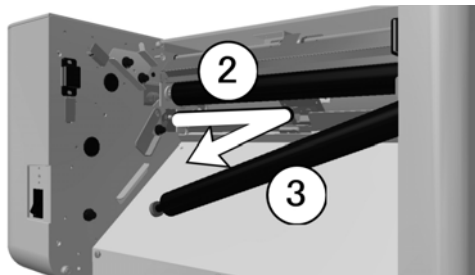
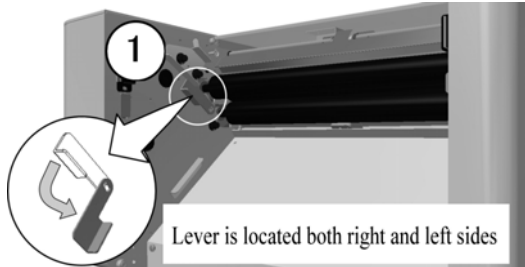

[How to remove the folder rollers]

Remove the rear cover and folding tables 1 and 2. Refer to the previous page.)

[1] Move down the roller setting lever to the OFF position.

The roller setting lever is located on both right and left sides.

[2] Slide the upper folder roller to the left.

(The shaft will come off from the left-side hole.)

[3] Remove the roller from the right-side hole.

By the same procedure, remove the lower folder roller.

- Clean the four rollers.

After the cleaning, in the reverse order of removal, set the lower roller first.

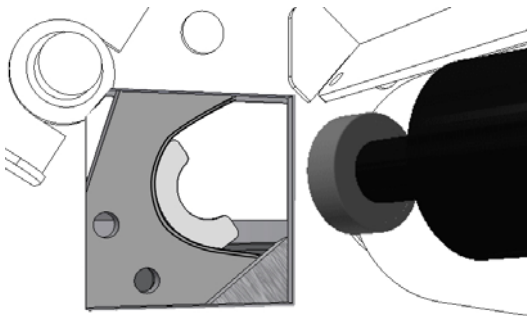

[How to set the folder roller]

[1] Insert the roller deep to the right.

[2] Slide the roller to the left.

[3] Move up the roller setting lever to the ON position.

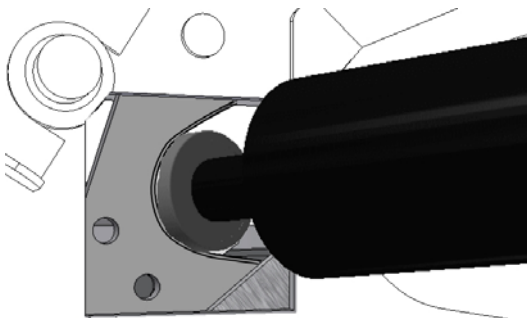

Caution !

If the roller is not firmly set, it may cause mechanical troubles. If it cannot be fixed, contact your dealer as shown on the back cover.

6-5 : Cleaning of the paper feed, double feed detection, paper ejection photo sensors

[Cleaning the paper ejection photo sensor]

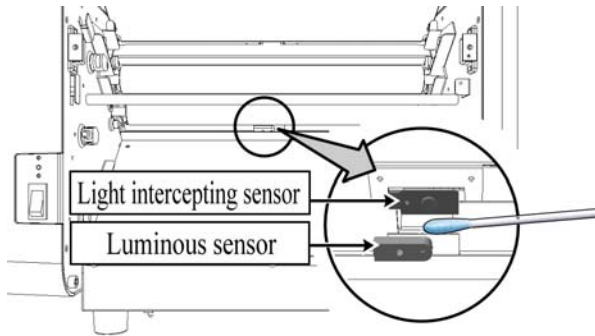
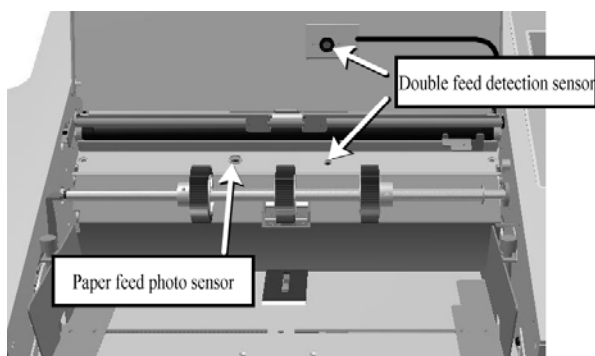

Diagram showing that the folder roller is removed (Refer to the figure on page 46.)

If only one sheet of paper is being fed, remove the paper dust on the part of the paper ejection photo sensor indicated by the arrow, using a soft cotton swab.

[Cleaning the paper feed and double feed detection photo sensors]]



Open the safety cover, and using an air duster, clean [1] the surface of the paper feed photo sensor (black resin face), and [2] the surface of the double feed detection sensor.

(Instead of an air duster, a damp, but not dripping, cotton swab or similar implement may be used.)

Caution !

**If using a cotton swab to clean the sensors, ensure that no cotton lint is left behind.
Insufficient cleaning may cause the paper feed to stop, or an error to occur after only the first sheet of paper is fed.
Only turn the machine on when the sensor has fully dried after cleaning.**

6-6 : Removal and installation of paper separator, paper feed rubber roller, brake rubber

When replacing the paper feed rubber roller and paper separator, remove them in the following manner.

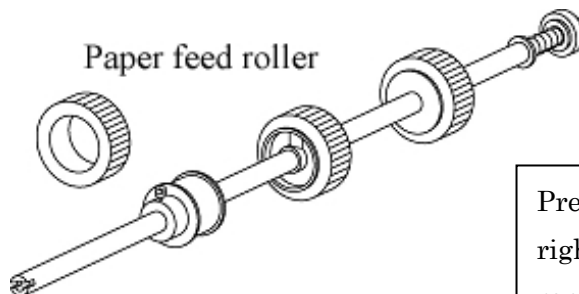
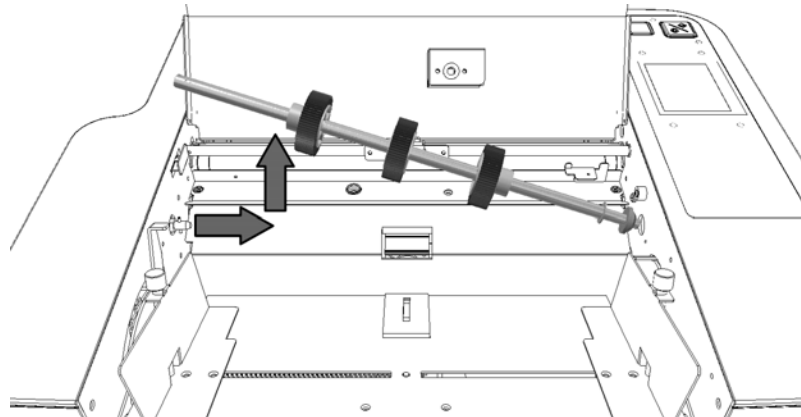

Press paper feed roller shaft to the right and spring loaded shaft will be removed without tools.

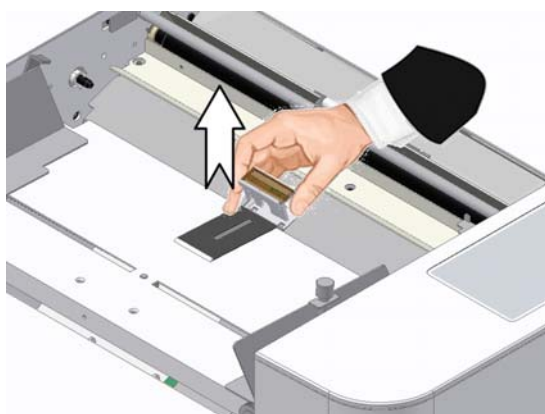

Hold both ends of the paper separator (covered with resin) and pull it out.

When fitting it, proceed in the reverse order to the removal process.

To purchase above parts, contact your dealer.

7. Trouble shooting and correction

7-1 : Error display

7-1-1 : Error display screen

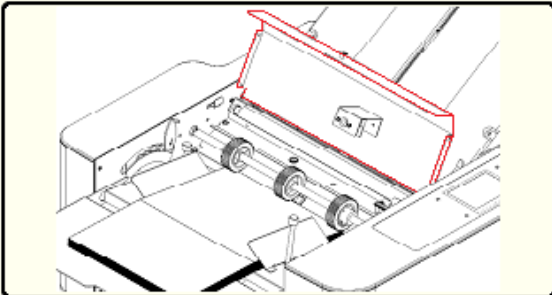

The Safety Upper Cover is open.
Close The Safety Cover.

OK

When an error occurs, location of trouble and error code will be shown in the display.

Remove the cause of error first and then press “OK” key and the specific error display will be cleared.

[Typical error correction display screens]

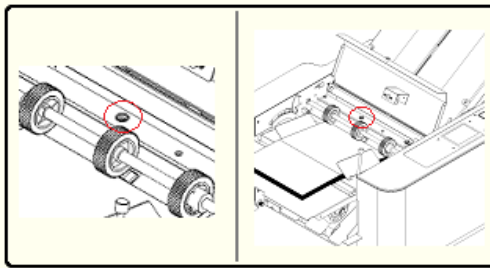

The Paper Feed Sensor is dirty.
Clean The Paper Feed Sensor.

OK

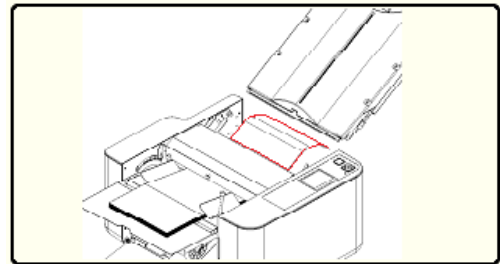

Paper jam occurred near The Folding Rollers.
Remove the jammed paper.

OK

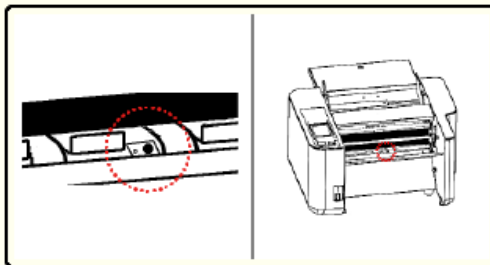

The Paper Ejection Sensor is dirty.
Clean The Paper Ejection Sensor.

OK

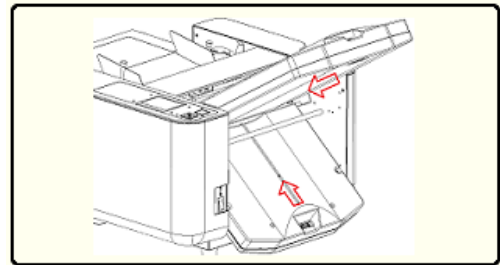

Reset the Folding Table 1 or Table 2.

OK

7-1-2 : List of Error Codes

Error Code	Symptom	Countermeasures.
E-02	There is no paper, or the paper is not activating paper detection switch due to light weight.	Reset the paper or add some sheets of paper. When there are only a few sheets of paper, the paper detection switch may not be able to detect it.
E-03	The paper did not reach as far as the paper feed sensor.	Paper feed slip occurred. Reset the paper and restart the operation.
E-04	The paper feed sensor is dirty.	Clean the paper feed sensor. (Refer to “6-5” on page 42)
E-05	Paper jam occurred near the paper feed sensor.	Remove the paper and restart the operation.
E-20	Paper jam occurred near the paper ejection sensor.	Remove the jammed paper.
E-21	The paper ejection sensor is dirty.	Clean the paper ejection sensor. (Refer to “6-5 on page 42)
E-30	The safety cover (upper or rear cover) is open.	Close the safety cover.
E-31	The Folding Table 1 or Table 2 didn't move right.	Reset the Folding Table 1 or Table 2.
E-32	The Folding Table 1 didn't move right.	Insert the plug into the Table 1 Connector.
E-33	The Folding Table 2 didn't move right.	Insert the plug into the Table 2 Connector.
E-52	Double feed.	Two or more sheets were fed. Check the ejected paper. Also, fan out the loaded paper sufficiently and restart the operation.
E-53	The first sheet was double fed.	Two or more sheets were fed. Check the ejected paper. Also, fan out the loaded paper sufficiently and restart the operation.
E-70	Motor has stopped.	Paper jam occurred near the Folding Rollers. Remove the jammed paper.
E-90	EEPROM Error.	Turn off power and turn on power again.. If it is not resolved, contact your dealer.
E-91	Touch panel communication error	Reload the power. If it is not resolved, contact your dealer.

7-2 : Troubleshooting

Problem	Possible Cause	Countermeasure	Reference
Folding misalignment occurs.	Fine adjustment is not made.	Correct the misalignment using the fine adjustment knob.	5.6 Adjustment
	The processing speed was changed during operation.	Do not change the speed during specified folding operation.	
	The folding roller is dirty.	Clean the folding roller.	6. Maintenance, Inspection, Expendables
	The paper guides are fixed in the right angle or not in close contact with the paper.	Make the paper guide in close contact with the paper.	
	The paper feed table is not set in the right angle.	Straighten the paper feed table using the slant adjustment knob	5.6.1 Slant adjustment
	The paper is cut at a slant.	Correct it using the slant adjustment knob.	
	Paper is thin or curled paper is used.	Replace the paper or (if possible) turn it over.	
Paper jam frequently occurs.	The folding roller is dirty.	Clean the folding roller	6. Maintenance, Inspection, Expendables
	Folding roller is not properly set.	Set the folding roller properly.	
	Paper out of specification is used.	Use a designated paper.	
	Thicker paper is folded at a slower speed.	Increase the speed.	5.10 Speed adjustment
	The folding tables 1 and 2 are not properly set.	Set the folding tables 1 and 2 properly.	
	Some torn paper is stuck at location where paper passes.	Check where the part is and remove the foreign paper.	
	The paper feed roller is dirty.	Clean the paper feed roller.	6. Maintenance, Inspection, Expendables
	Extreme static electricity	Spray commercially available antistatic spray.	
Paper is not fed even when the "START" key is pressed.	There is no paper or only a few sheets on the paper feed table.	Load the paper on the paper feed table.	
	The upper roller or rear cover is open.	Close the cover.	
	The paper ejection photo sensor is dirty.	Clean the paper ejection photo sensor.	6.6 Cleaning of the photo sensor
Folded paper is wrinkled.	Paper is coiled around the folder roller.	Remove the tables 1 and 2 and remove the paper from the folding roller.	6.5 Removal and installation of folder roller
	The folding roller is dirty.	Clean the folding roller.	6. Maintenance, Inspection, Expendables
	Short grain paper is used or paper is not enough stiffness.	Slow the processing speed.	5.10 Speed adjustment
	Paper out of specification is used.	Use a designated paper.	
	Paper is thin or curled paper is used.	Replace the paper or (if possible) turn it over(up side down).	

Problem	Possible Cause	Countermeasure	Reference
The power is not applied even when the power switch is turned on.	The power cable plug is not connected to the outlet.	Insert the power cable plug firmly into the outlet.	
	The circuit breaker is actuated.	Remove the cause (such as paper jam) and press the breaker button.	2.1 Appearance
Only about 3/4 inches of the front edge of the paper is folded	The brake in the folding tables 1 and 2 is locked.	Raise the brake rubber and release the lock.	6.9 Releasing the lock
Paper jam occurs frequently at ejection area.	The position of paper ejection roller is not suitable for the paper size and fold.	Set the paper ejection roller in the optimal position.	5.6.3 Adjustment of paper ejection roller
	Full of ejected paper.	Remove the paper.	
Paper feed slippage occurs frequently.	The paper feed roller is worn out.	Replace the paper feed roller.	
	The paper feed roller is stained or dirty with ink or paper dust.	Clean the paper feed roller.	6. Maintenance, Inspection, Expendables
	Paper out of specification is used.	Use a designated paper.	
	The paper separator is dirty.	Clean the paper separator.	6. Maintenance, Inspection, Expendables
Double feed frequently occurs.	The paper separator is worn out.	Replace the paper separator.	6. Maintenance, Inspection, Expendables
	The paper separator is dirty.	Clean the paper separator.	6. Maintenance, Inspection, Expendables
	Sheets of printed paper is sticking each other.	Reset the paper after fanning them out sufficiently.	
	Paper out of specification is used.	Use a designated paper.	
A paper corner is folded.	Extremely paper is curled.	Correct the curl.	
	Fine adjustment is not set properly.	Set the fine adjustment properly one again.	5.6.2 Fine adjustment
	The folding tables 1 and 2 are not set properly.	Set the folding tables 1 and 2 properly.	

Caution !

Even paper quality is within the specifications, if it has already been folded, or is curled or wavy due to the heat of a printing machine, copier, printer, etc., the machine may not be able to fold it properly.

8. Relocation or Disposal

8-1 : Relocation

8-1-1 : Removal of the machine from its present location

- Turn off the power switch.
- Remove the power plug from the wall outlet.
- Lower the auxiliary table.
- Raise the paper ejection table and put it on the paper feed table, and hang it on the pin.

8-1-2 : Transport

- Transport the removed parts, attachments and Operation Manual together with the machine.
- Do not to expose the machine to strong vibration or shock.
- Ensure that the machine is carried by two persons wearing protective gloves, holding the four corners of the machine base firmly.

8-1-3 : Installation

When installing the machine at its new location, observe the same procedure as when first installing it. (Refer to “4. Preparation.”)

8-2 : Disposal

When disposing of the machine, ask a contractor specialized in industrial waste disposal to handle it in accordance with the local regulations.

9. Specifications

Model:	408A
Paper Size	3.5" x 5.0" to 11" x 17" 3.5" X 5.0" size is for SINGLE fold only. 5" x 7.2" size cannot be folded into GATE.
Paper Weight	46.5g/ m ² ~ 160g/ m ² (160g/ m ² depends on paper size and quality.) 230g/ m ² only for single fold (230g/ m ² depends on paper size and quality.)
Paper Quality	High-quality paper, high-quality paper for stencil printing, medium-quality paper, woody paper, art/coated paper Even if paper is of the quality as recommended above, if it has already been folded, or is curled due to the heat of a printing machine, copier, printer, etc., the machine may not be able to fold it properly.
Folding Type	Single fold, double parallel fold, fold-out fold, letter fold, zigzag fold, gate fold, other non-standard fold patterns, cross fold using single fold
Fold dimension	Maximum fold dimensions Table 1: 12.6" (zigzag, double parallel, and fold-out) Table 2: 8.5" (single, gate, and letter)
	Minimum fold dimensions Table 1: 2.0" (gate and letter) Table 2: 1.6" (single, zigzag, double parallel, and fold-out)
Paper Feed System	Three-roller friction feed/separation system
Paper Stacking Capacity	500 sheets (20 lb bond)
Processing Speed	2,400 to 14,400 sheets per hour (based on single fold using letter size paper) When it is operating at the maximum speed, it stops when one sheet has passed after error occurs. Subject to some limitations depending on the fold type
Operation Method	Color LCD touch panel, automatic setting (based on built-in microcomputer)
Additional Functions	<ul style="list-style-type: none"> ▪ Fold skew adjustment, paper jam detection •4-digit counter (Addition/Subtraction modes, auto repeat) ▪ Automatic paper size detection (letter, legal & ledger sizes) ▪ Double feed detection ▪ Auxiliary paper guide for cross folding ▪ Automatic elevation of paper feed table ▪ 5-level automatic position switchover of paper ejection roller ▪ Automatic fold position setting by inputting paper size ▪ Memory of 36 patterns of fine adjustment (6 types of paper size x 6 fold types) ▪ Memory of 24 patterns of special folding
Power Consumption	50W
Power Supply Used	100-240VAC, 50/60 Hz
Dimensions	W 40 1/2" x D 21 1/2" x H 20" (during use) W 18" x D 21 1/2" x H 13" (during storage)
Net Weight	68 lb

The specifications and appearance of this machine are subject to change without notice for further improvement.

MEMO

MEMO

MBM Corporation