

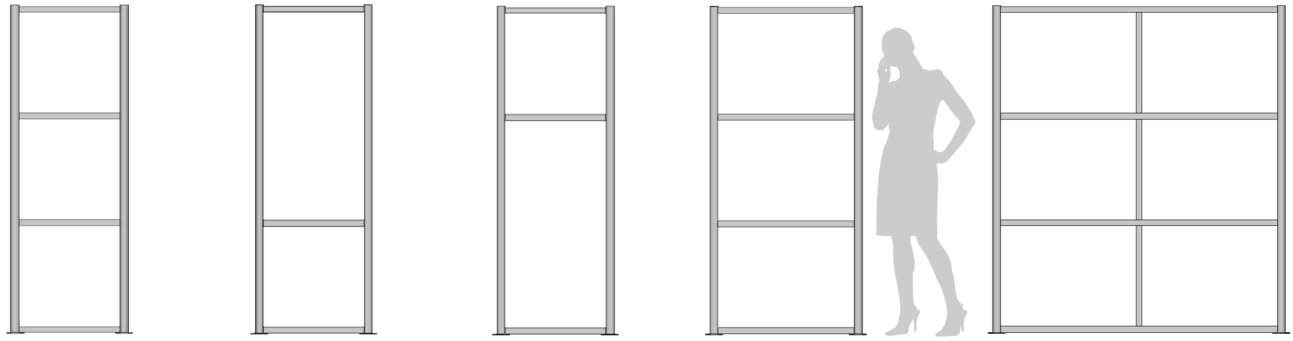

## 27", 35", 68" Wide Frame Diagrams

Assembly Instructions Start on Page 22

Width	27" w	27" w	27" w	35" w	68" w
Height	75" h	75" h	75" h	75" h	75" h



Model Number	<b>SW2775-1</b> FULL UNIT (2 SUPPORT POSTS)	<b>SW2775-2</b> FULL UNIT (2 SUPPORT POSTS)	<b>SW2775-3</b> FULL UNIT (2 SUPPORT POSTS)	<b>SW3575</b> FULL UNIT (2 SUPPORT POSTS)	<b>SW6875</b> FULL UNIT (2 SUPPORT POSTS)
--------------	---	---	---	---	---

Width	27" w	27" w	35" w	68" w
Height	51" h	51" h	51" h	51" h

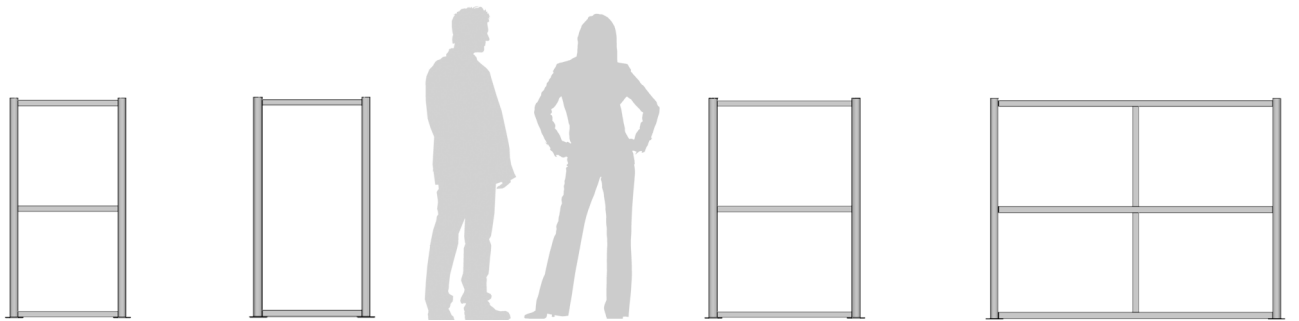

Model Number	<b>SW2751-1</b> FULL UNIT (2 SUPPORT POSTS)	<b>SW2751-2</b> FULL UNIT (2 SUPPORT POSTS)	<b>SW3551</b> FULL UNIT (2 SUPPORT POSTS)	<b>SW6851</b> FULL UNIT (2 SUPPORT POSTS)
--------------	---	---	---	---

### Specifications

**Modular Sizes**  
Widths: 27", 35", 51", 60", 68", 75", 84", 92", 100", 118", 133", 148" or connect to create almost any length desired.  
Heights: 51", 58", 75"

**Frame Finishes**  
Clear anodized satin aluminum finish. Custom powder coat paint finishes available.

**Panels**  
1/4" thick panels are available in a variety of translucent and opaque materials, wood grain laminate and colors.

**Support Bases**  
3/16" thick steel with satin aluminum color powder coat paint. Powder coat paint finishes available.

**Frames**  
2" diameter round vertical support post.  
3/4" thick by 1 3/8" high horizontal and vertical panel frames.

**NOTE:**  
iDivide partitions are to be only used as a visual screen. The iDivide StudioWall office partitions and room dividers are not to be used as structural walls and should not be leaned against, have anything hung upon, or be climbed upon for any reason.  
The partitions do not provide a raceway or space for electrical conduit or cabling. Please contact iDivide for specifications and clearance dimensions for IT cabling and Electrical power considerations.

## 51" Wide Frame Diagrams

Assembly Instructions Start on Page 22

Width	51" w	51" w	51" w	51" w
Height	75" h	75" h	75" h	75" h

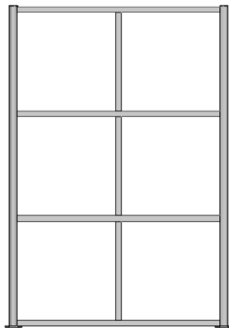

**SW5175-1**  
FULL UNIT  
(2 SUPPORT POSTS)

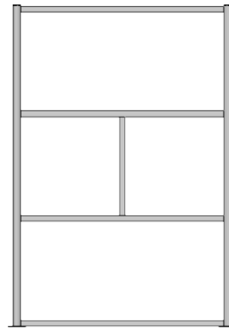

**SW5175-2**  
FULL UNIT  
(2 SUPPORT POSTS)

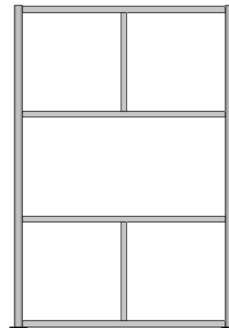

**SW5175-3**  
FULL UNIT  
(2 SUPPORT POSTS)

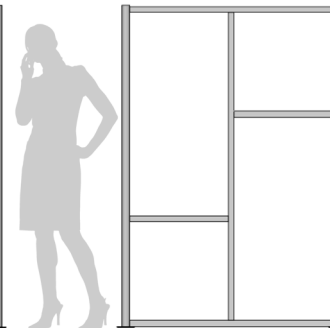

**SW5175-4**  
FULL UNIT  
(2 SUPPORT POSTS)

Width	51" w	51" w	51" w	51" w
Height	51" h	51" h	51" h	51" h

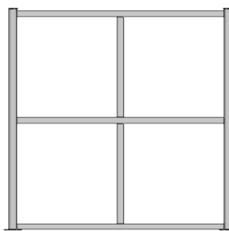

**SW5151-1**  
FULL UNIT  
(2 SUPPORT POSTS)

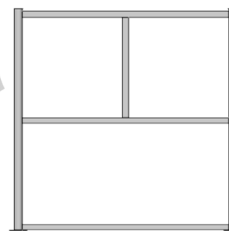

**SW5151-2**  
FULL UNIT  
(2 SUPPORT POSTS)

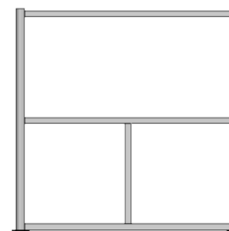

**SW5151-3**  
FULL UNIT  
(2 SUPPORT POSTS)

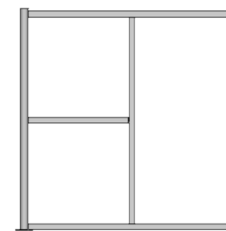

**SW5151-4**  
FULL UNIT  
(2 SUPPORT POSTS)

### Insert Panel Sizes



Small Square



Medium Rectangular

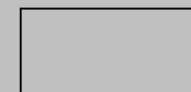

Large Rectangular



## 51" Wide Frame Diagrams

Assembly Instructions Start on Page 22

Width	51" w	51" w	51" w	51" w
Height	75" h	75" h	75" h	75" h

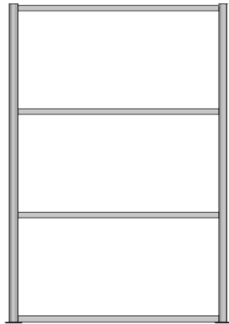

**Model Number**  
**SW5175-5**  
FULL UNIT  
(2 SUPPORT POSTS)

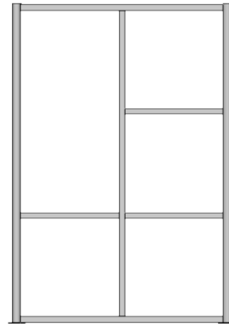

**Model Number**  
**SW5175-6**  
FULL UNIT  
(2 SUPPORT POSTS)

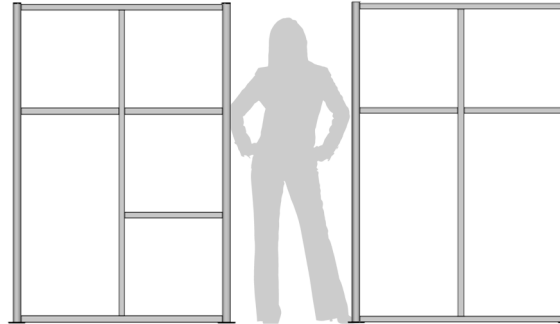

**Model Number**  
**SW5175-7**  
FULL UNIT  
(2 SUPPORT POSTS)

**Model Number**  
**SW5175-8**  
FULL UNIT  
(2 SUPPORT POSTS)

Width	51" w	51" w
Height	51" h	51" h

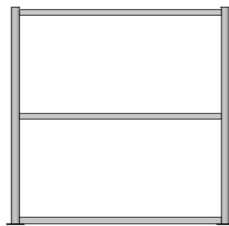

**Model Number**  
**SW5151-5**  
FULL UNIT  
(2 SUPPORT POSTS)

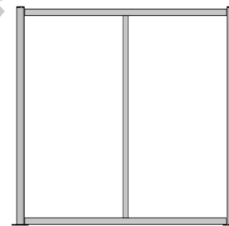

**Model Number**  
**SW5151-6**  
FULL UNIT  
(2 SUPPORT POSTS)

### Insert Panel Sizes



Small Square



Medium Rectangular

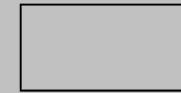

Large Rectangular



## 60" Wide Frame Diagrams

Assembly Instructions Start on Page 22

Width 60" w  
Height 75" h

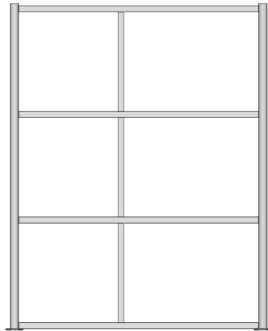

**Model Number** SW6075-1  
FULL UNIT  
(2 SUPPORT POSTS)

Width 60" w  
Height 75" h

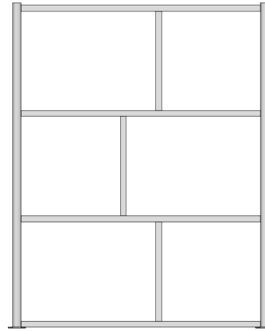

**Model Number** SW6075-2  
FULL UNIT  
(2 SUPPORT POSTS)

Width 60" w  
Height 75" h

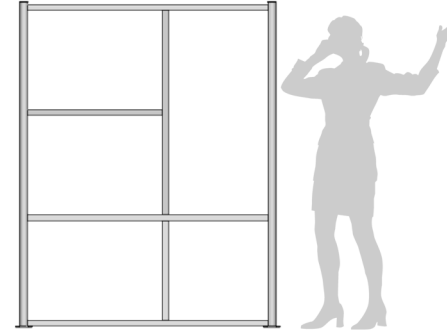

**Model Number** SW6075-3  
FULL UNIT  
(2 SUPPORT POSTS)

Width 60" w  
Height 51" h

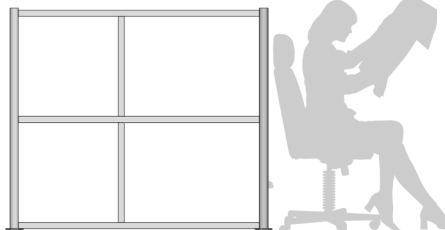

**Model Number** SW6051-1  
FULL UNIT  
(2 SUPPORT POSTS)

Width 60" w  
Height 51" h

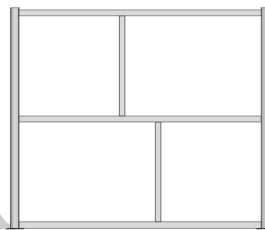

**Model Number** SW6051-2  
FULL UNIT  
(2 SUPPORT POSTS)

Width 60" w  
Height 51" h

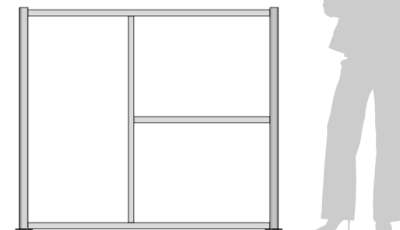

**Model Number** SW6051-3  
FULL UNIT  
(2 SUPPORT POSTS)

### Insert Panel Sizes



Small Square



Medium Rectangular



Large Rectangular



SW6075-3



## 60" Wide Frame Diagrams

Assembly Instructions Start on Page 22

Width	60" w	60" w	60" w
Height	75" h	75" h	75" h

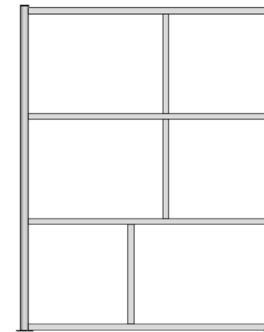
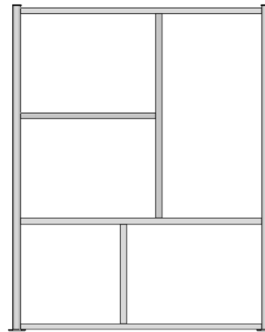
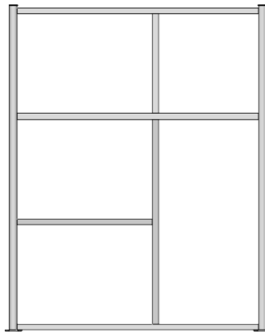

### Insert Panel Sizes



Small Square

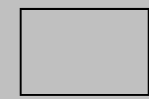

Medium Rectangular

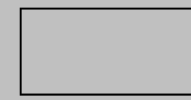

Large Rectangular

**Model Number** **SW6075-4**  
FULL UNIT  
(2 SUPPORT POSTS)

**Model Number** **SW6075-5**  
FULL UNIT  
(2 SUPPORT POSTS)

**Model Number** **SW6075-6**  
FULL UNIT  
(2 SUPPORT POSTS)

SW6075-2

SW6075-5

SW6075-3



## 75" Wide Frame Diagrams

Assembly Instructions Start on Page 22

Width	75" w	75" w	75" w
Height	75" h	75" h	75" h

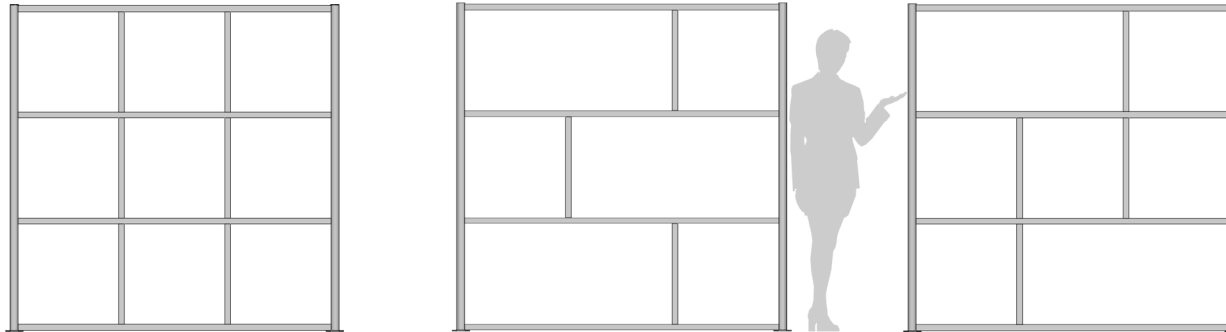

**Model Number** **SW7575-1**  
FULL UNIT  
(2 SUPPORT POSTS)

**Model Number** **SW7575-2**  
FULL UNIT  
(2 SUPPORT POSTS)

**Model Number** **SW7575-3**  
FULL UNIT  
(2 SUPPORT POSTS)

Width	75" w	75" w	75" w
Height	51" h	51" h	51" h

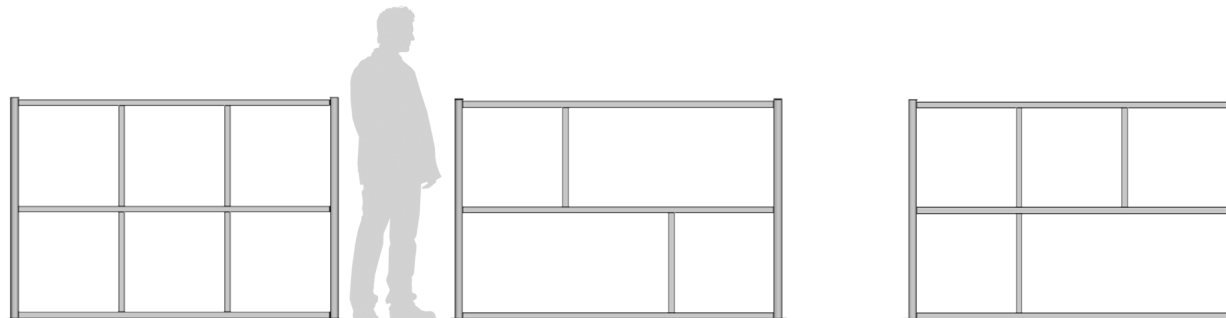

**Model Number** **SW7551-1**  
FULL UNIT  
(2 SUPPORT POSTS)

**Model Number** **SW7551-2**  
FULL UNIT  
(2 SUPPORT POSTS)

**Model Number** **SW7551-3**  
FULL UNIT  
(2 SUPPORT POSTS)

### Insert Panel Sizes



Small Square



Medium Rectangular

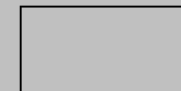

Large Rectangular

SW7575-2



SW7551-2



## 75" Wide Frame Diagrams

Assembly Instructions Start on Page 22

Width	75" w	75" w	75" w
Height	75" h	75" h	75" h

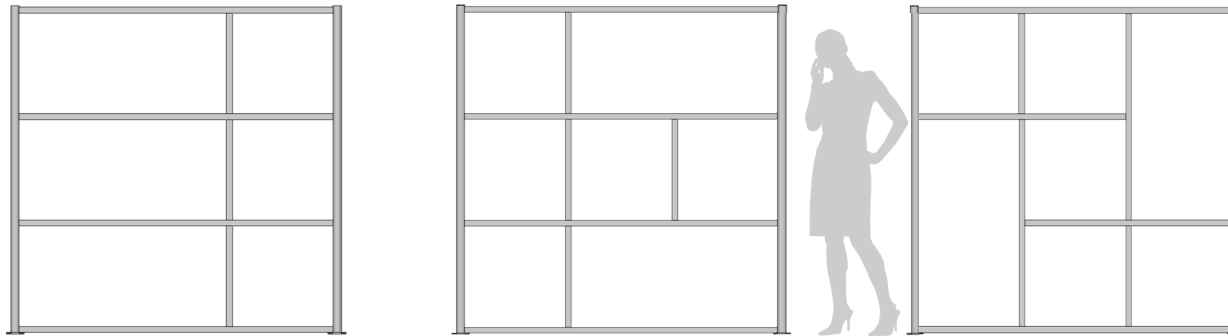

<b>Model Number</b>	<b>SW7575-4</b> FULL UNIT (2 SUPPORT POSTS)	<b>SW7575-5</b> FULL UNIT (2 SUPPORT POSTS)	<b>SW7575-6</b> FULL UNIT (2 SUPPORT POSTS)
---------------------	---	---	---

### Insert Panel Sizes

Small Square

Medium Rectangular

Large Rectangular

Width	75" w	75" w	75" w	75" w
Height	51" h	51" h	51" h	51" h

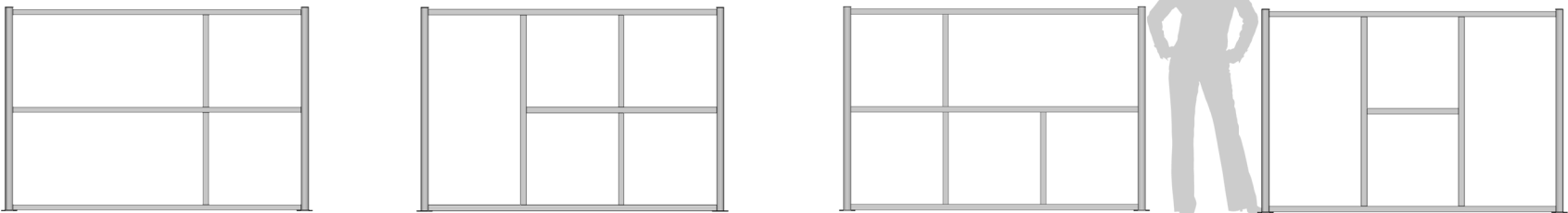

<b>Model Number</b>	<b>SW7551-4</b> FULL UNIT (2 SUPPORT POSTS)	<b>SW7551-5</b> FULL UNIT (2 SUPPORT POSTS)	<b>SW7551-6</b> FULL UNIT (2 SUPPORT POSTS)	<b>SW7551-7</b> FULL UNIT (2 SUPPORT POSTS)
---------------------	---	---	---	---

## 75" Wide Frame Diagrams

Assembly Instructions Start on Page 22

Width	75" w	75" w	75" w
Height	75" h	75" h	75" h

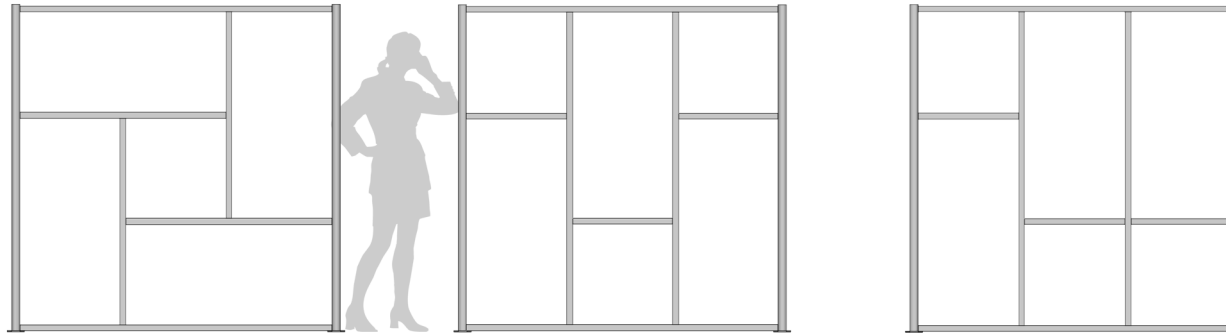

Model Number	<b>SW7575-7</b> FULL UNIT (2 SUPPORT POSTS)	<b>SW7575-8</b> FULL UNIT (2 SUPPORT POSTS)	<b>SW7575-9</b> FULL UNIT (2 SUPPORT POSTS)
--------------	---	---	---

Width	75" w	75" w	75" w
Height	75" h	75" h	75" h

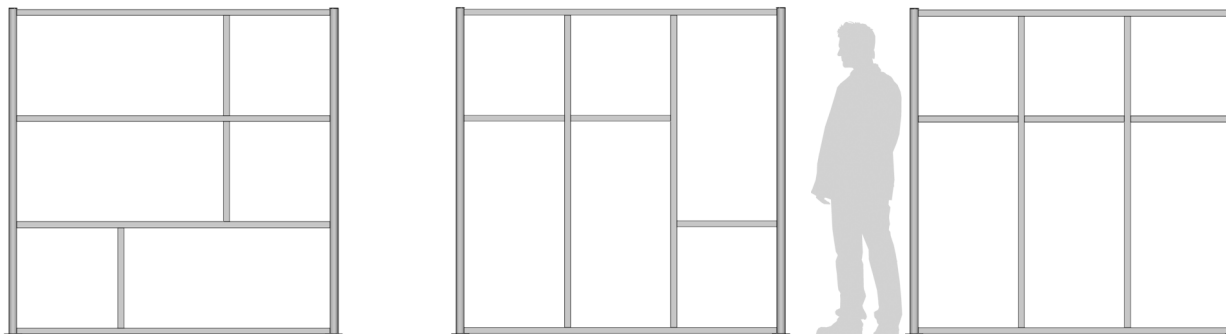

Model Number	<b>SW7575-10</b> FULL UNIT (2 SUPPORT POSTS)	<b>SW7551-11</b> FULL UNIT (2 SUPPORT POSTS)	<b>SW7551-12</b> FULL UNIT (2 SUPPORT POSTS)
--------------	--	--	--

### Insert Panel Sizes



Small Square



Medium Rectangular

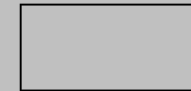

Large Rectangular





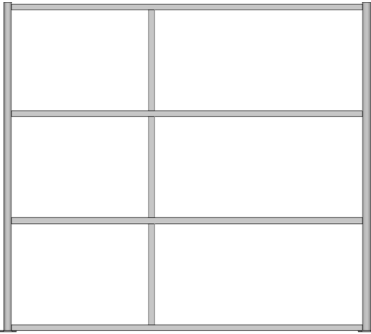
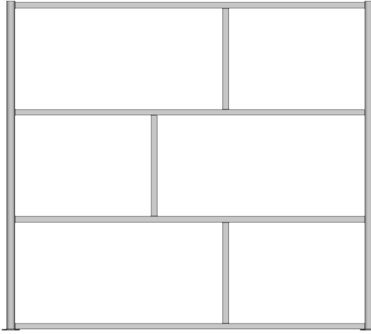
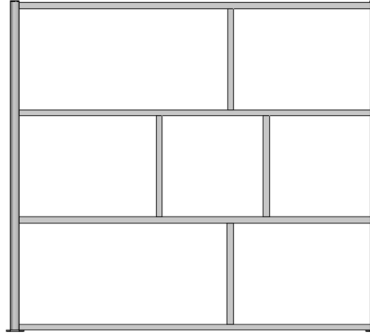
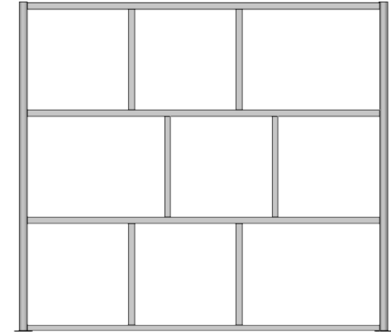

## 84" Wide Frame Diagrams

Assembly Instructions Start on Page 22

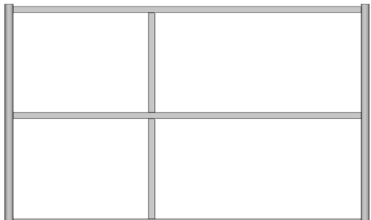
Width	84" w	84" w	84" w	84" w
Height	75" h	75" h	75" h	75" h
				
Model Number	<b>SW8475-1</b> FULL UNIT (2 SUPPORT POSTS)	<b>SW8475-2</b> FULL UNIT (2 SUPPORT POSTS)	<b>SW8475-3</b> FULL UNIT (2 SUPPORT POSTS)	<b>SW8475-4</b> FULL UNIT (2 SUPPORT POSTS)

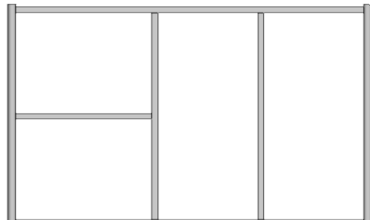
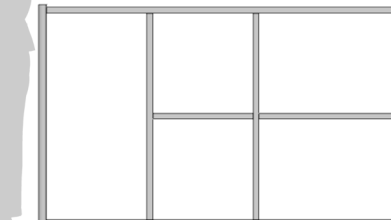
Width	84" w	84" w	84" w	84" w
Height	51" h	51" h	51" h	51" h
				
Model Number	<b>SW8451-1</b> FULL UNIT (2 SUPPORT POSTS)	<b>SW8475-2</b> FULL UNIT (2 SUPPORT POSTS)	<b>SW8475-3</b> FULL UNIT (2 SUPPORT POSTS)	<b>SW8475-4</b> FULL UNIT (2 SUPPORT POSTS)

## 84" Wide Frame Diagrams

Assembly Instructions Start on Page 22

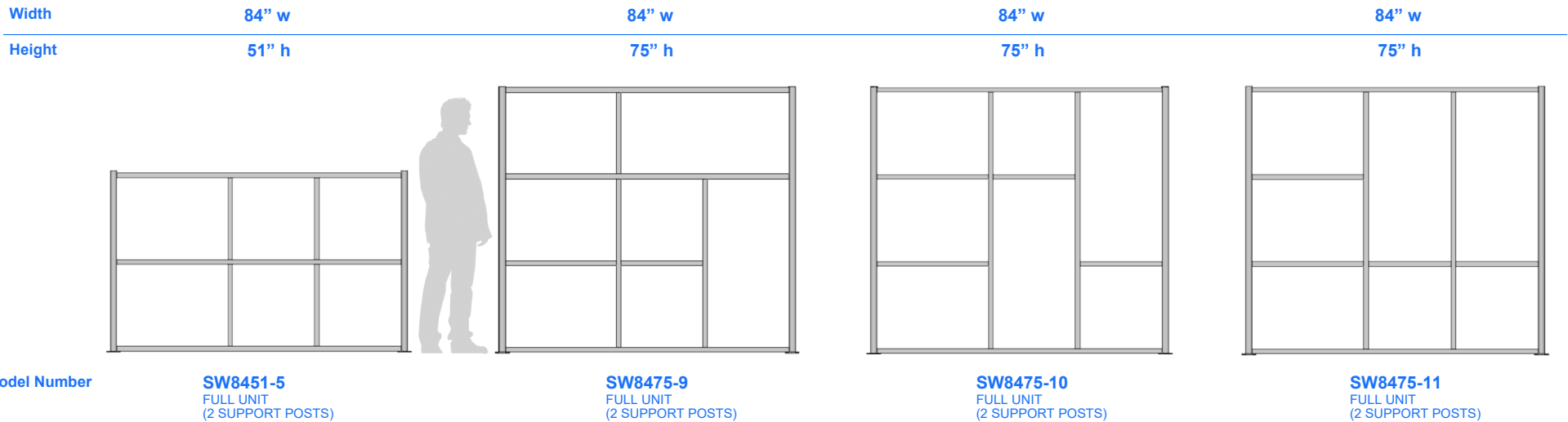
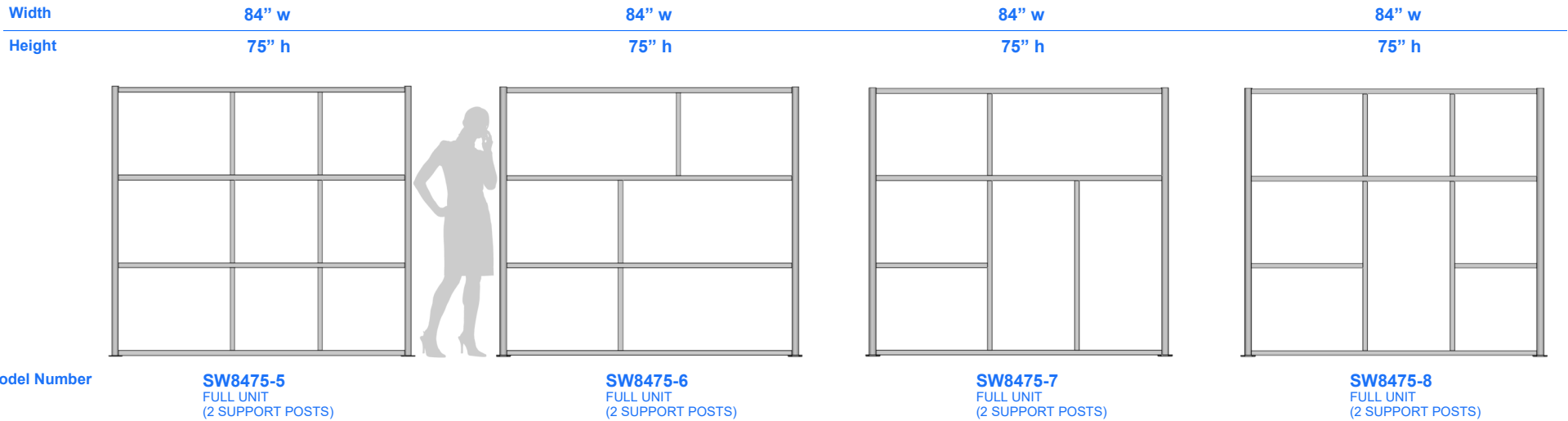

## 92" Wide Frame Diagrams

Assembly Instructions Start on Page 22

Width 92" w

Height 75" h

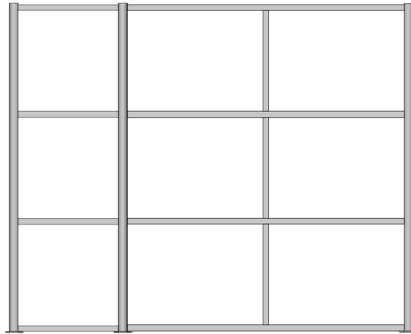

Model Number

**SW9275-1**  
FULL UNIT  
(3 SUPPORT POSTS)

92" w

75" h

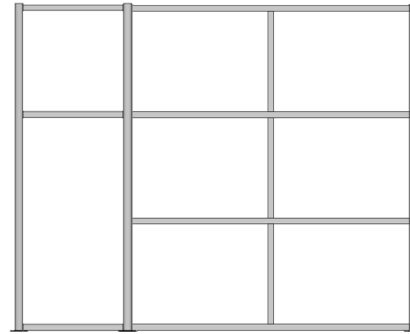

**SW9275-2**  
FULL UNIT  
(3 SUPPORT POSTS)



92" w

75" h

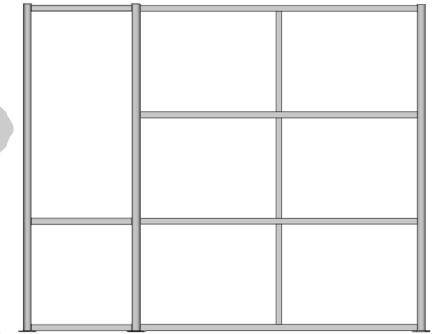

**SW9275-3**  
FULL UNIT  
(3 SUPPORT POSTS)

Width 92" w

Height 51" h



Model Number

**SW9251-1**  
FULL UNIT  
(3 SUPPORT POSTS)

92" w

51" h



**SW9251-2**  
FULL UNIT  
(3 SUPPORT POSTS)



92" w

75" h

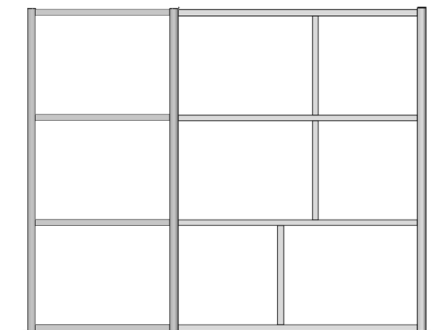

**SW9275-4**  
FULL UNIT  
(3 SUPPORT POSTS)

## 100" Wide Frame Diagrams

Assembly Instructions Start on Page 22

Width 100" w

Height 75" h

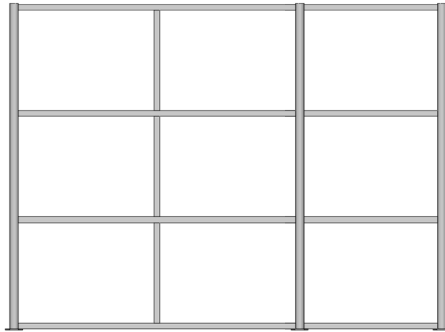

Model Number

**SW10075-1**  
FULL UNIT  
(3 SUPPORT POSTS)

100" w

75" h

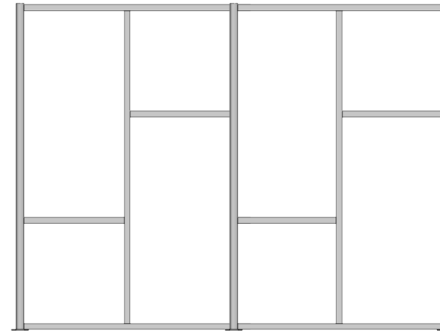

**SW10075-2**  
FULL UNIT  
(3 SUPPORT POSTS)

100" w

75" h

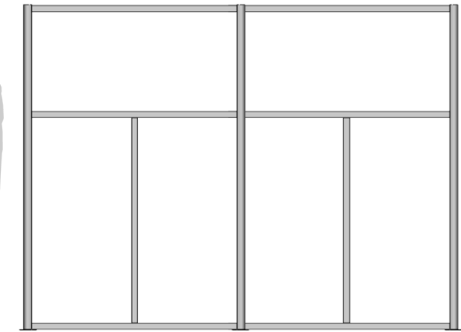

**SW10075-3**  
FULL UNIT  
(3 SUPPORT POSTS)

Width 100" w

Height 51" h

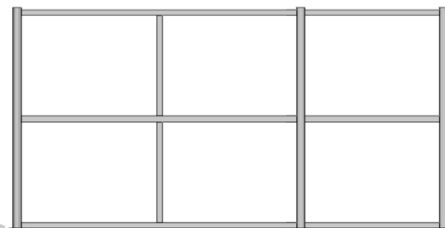

Model Number

**SW10051-1**  
FULL UNIT  
(3 SUPPORT POSTS)

100" w

51" h



**SW10051-2**  
FULL UNIT  
(3 SUPPORT POSTS)

100" w

51" h



**SW10051-3**  
FULL UNIT  
(3 SUPPORT POSTS)

## 100" Wide Frame Diagrams

Assembly Instructions Start on Page 22

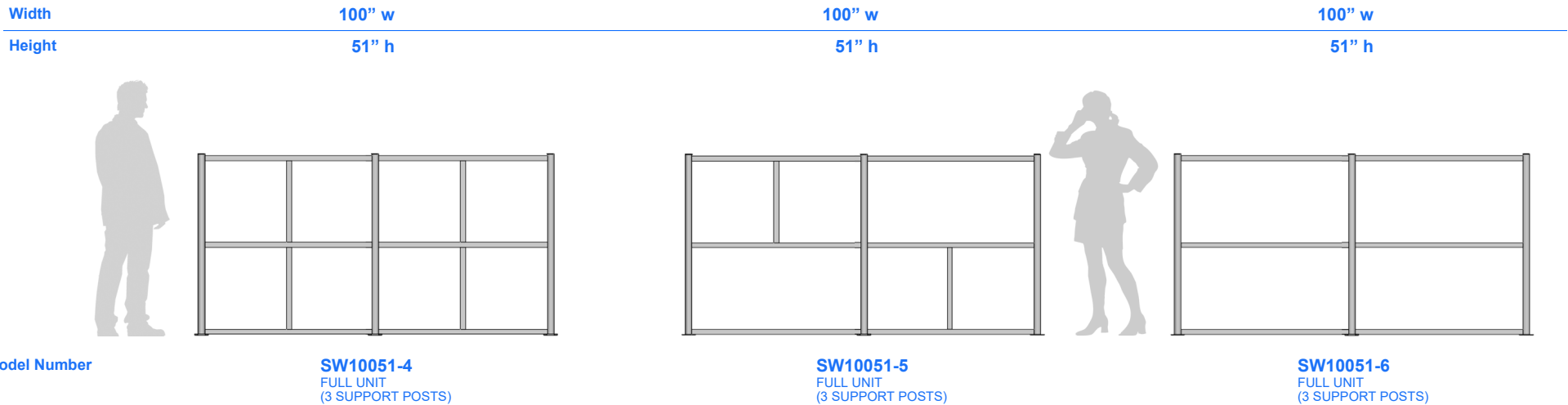
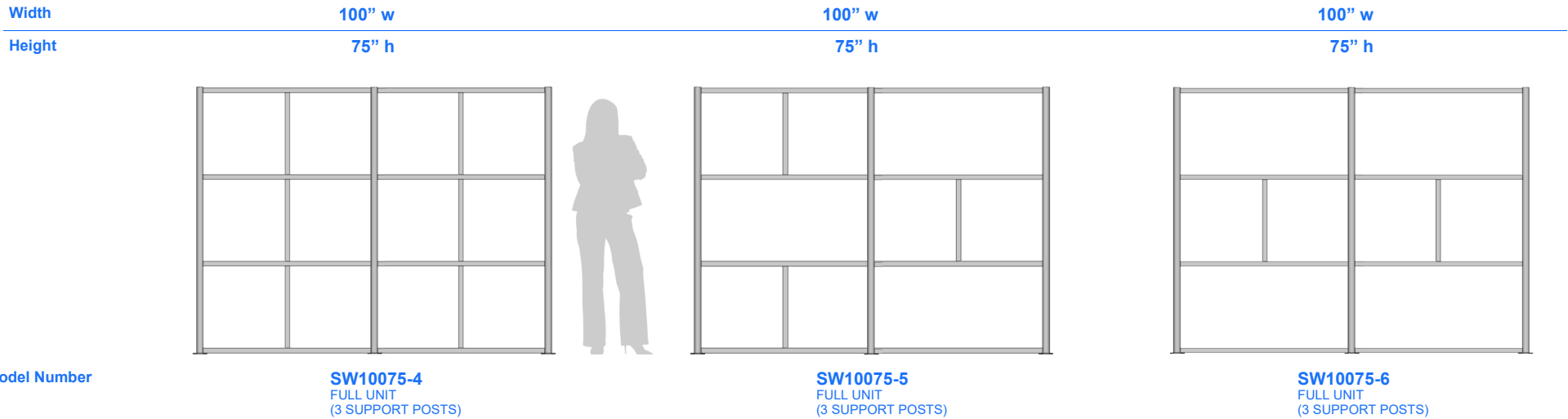



## 100" Wide Frame Diagrams

Assembly Instructions Start on Page 22

Width 100" w

Height 75" h



Model Number

**SW10075-7**  
FULL UNIT  
(3 SUPPORT POSTS)

100" w

75" h

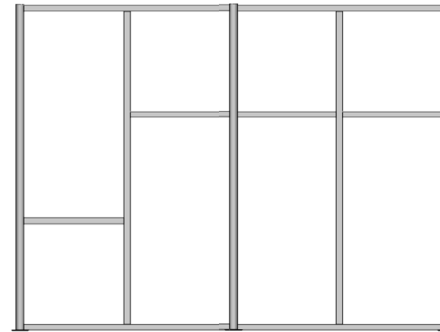

**SW10075-8**  
FULL UNIT  
(3 SUPPORT POSTS)

100" w

75" h

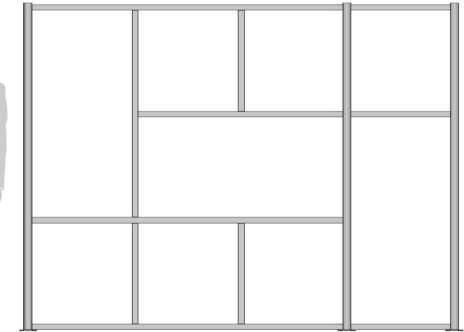

**SW10075-9**  
FULL UNIT  
(3 SUPPORT POSTS)

Width 100" w

Height 51" h



Model Number

**SW10051-7**  
FULL UNIT  
(3 SUPPORT POSTS)

100" w

51" h

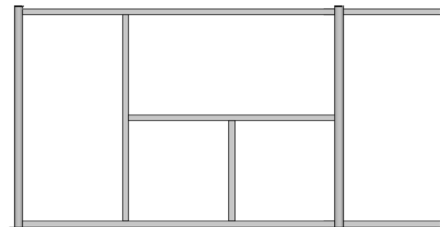

**SW10051-8**  
FULL UNIT  
(3 SUPPORT POSTS)

100" w

51" h

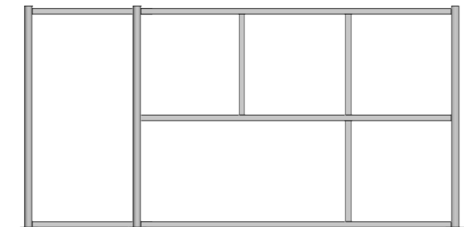

**SW10051-9**  
FULL UNIT  
(3 SUPPORT POSTS)

## 100" Wide Frame Diagrams

Assembly Instructions Start on Page 22

Width 100" w

Height 75" h

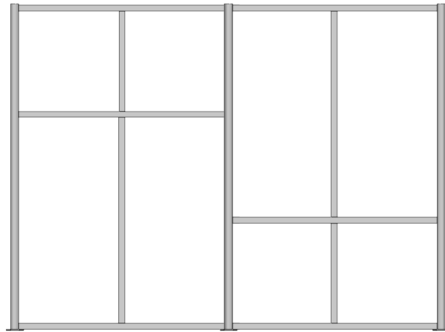

Model Number

**SW10075-10**  
FULL UNIT  
(3 SUPPORT POSTS)

100" w

75" h

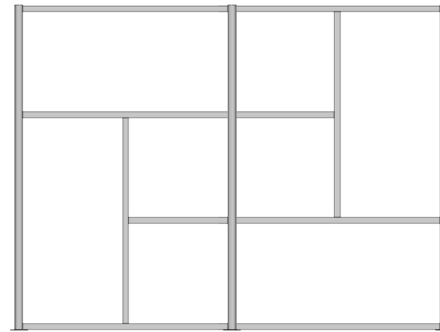

**SW10075-11**  
FULL UNIT  
(3 SUPPORT POSTS)

100" w

75" h

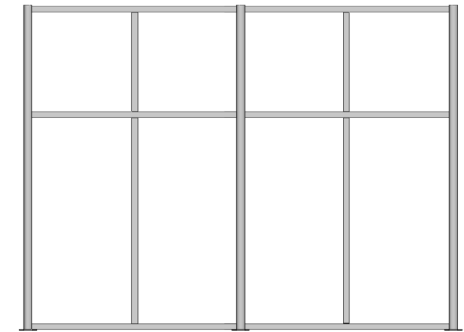

**SW10075-12**  
FULL UNIT  
(3 SUPPORT POSTS)

Width 100" w

Height 51" h



Model Number

**SW10051-10**  
FULL UNIT  
(3 SUPPORT POSTS)

100" w

51" h

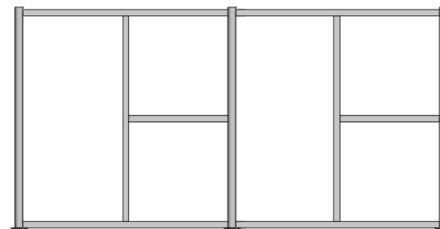

**SW10051-11**  
FULL UNIT  
(3 SUPPORT POSTS)

100" w

51" h

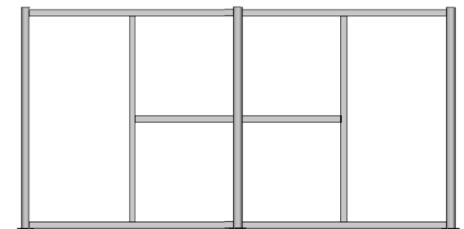

**SW10051-12**  
FULL UNIT  
(3 SUPPORT POSTS)



## 100" Wide Frame Diagrams

Assembly Instructions Start on Page 22

Width 118" w

Height 75" h

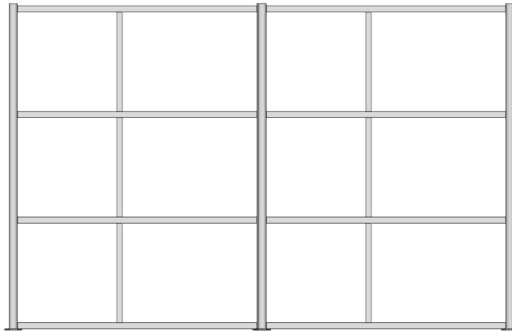

Model Number

**SW11875-1**  
FULL UNIT  
(3 SUPPORT POSTS)

Width 118" w

Height 75" h

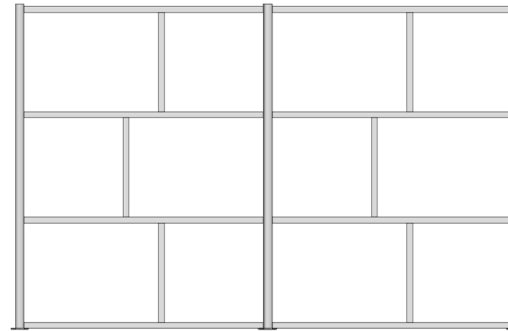

**SW11875-2**  
FULL UNIT  
(3 SUPPORT POSTS)

Width 118" w

Height 75" h

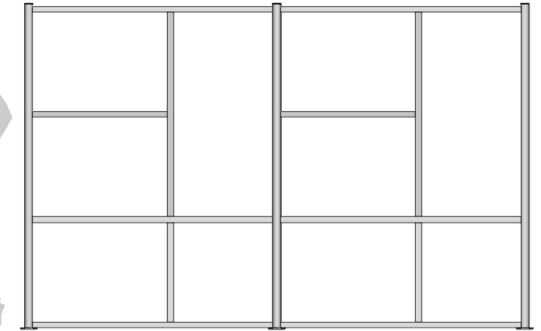

**SW11875-3**  
FULL UNIT  
(3 SUPPORT POSTS)

Width 100" w

Height 51" h



Model Number

**SW11851-1**  
FULL UNIT  
(3 SUPPORT POSTS)

Width 100" w

Height 51" h



**SW11851-2**  
FULL UNIT  
(3 SUPPORT POSTS)

Width 100" w

Height 51" h

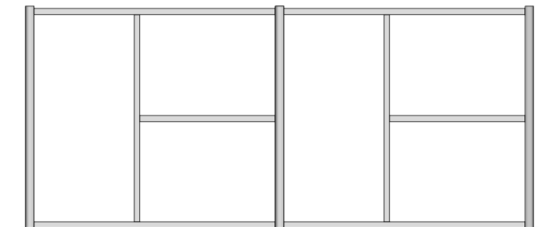

**SW11851-3**  
FULL UNIT  
(3 SUPPORT POSTS)



## 124" Wide Frame Diagrams

Assembly Instructions Start on Page 22

Width 124" w

Height 75" h

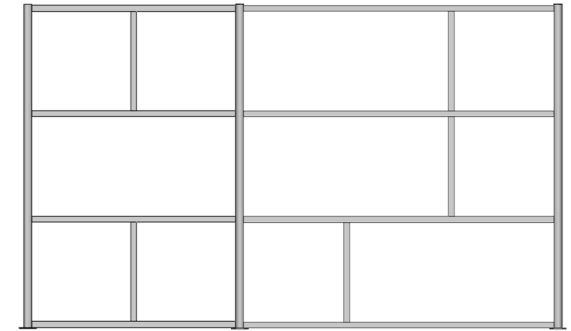
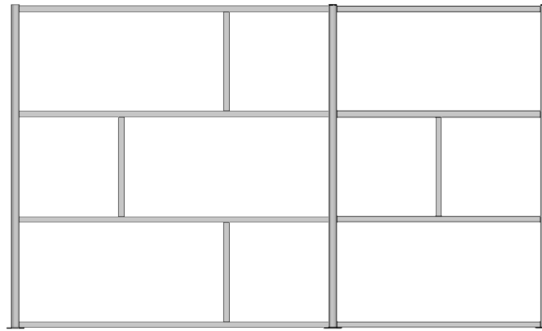
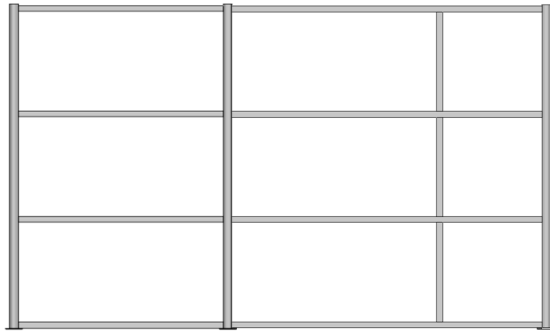

Model Number

**SW12475-1**  
FULL UNIT  
(3 SUPPORT POSTS)

**SW12475-2**  
FULL UNIT  
(3 SUPPORT POSTS)

**SW12475-3**  
FULL UNIT  
(3 SUPPORT POSTS)

Width 124" w

Height 51" h

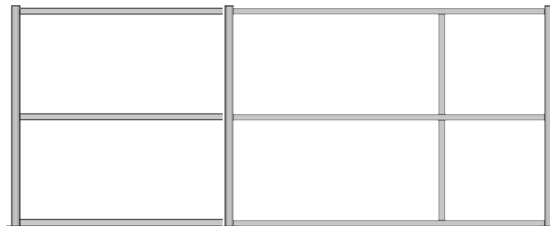

Model Number

**SW12451-1**  
FULL UNIT  
(3 SUPPORT POSTS)

**SW12451-2**  
FULL UNIT  
(3 SUPPORT POSTS)

**SW12451-3**  
FULL UNIT  
(3 SUPPORT POSTS)

## 133" Wide Frame Diagrams

Assembly Instructions Start on Page 22

Width 133" w  
Height 75" h

133" w  
75" h

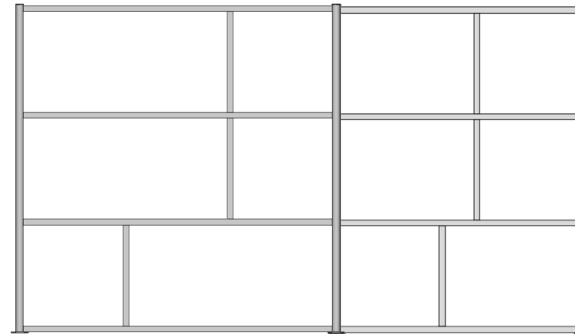
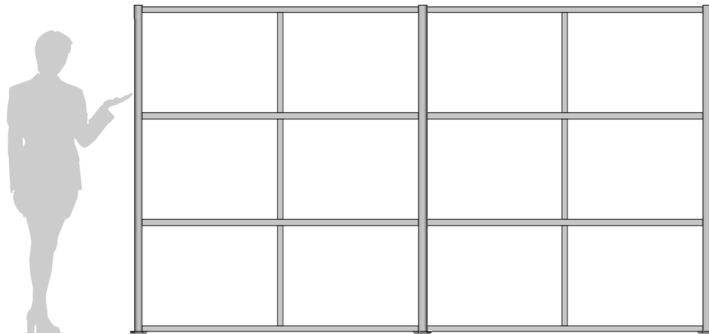

**Model Number** SW13375-1  
FULL UNIT  
(3 SUPPORT POSTS)

**Model Number** SW13375-2  
FULL UNIT  
(3 SUPPORT POSTS)

Width 133" w  
Height 51" h

133" w  
51" h

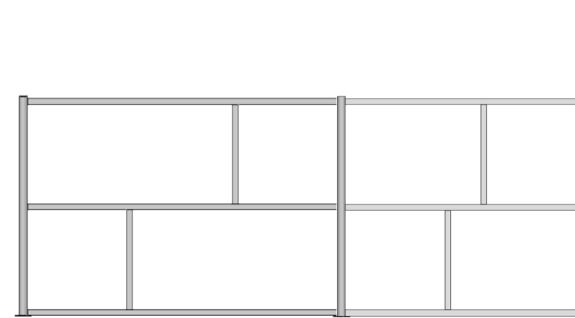
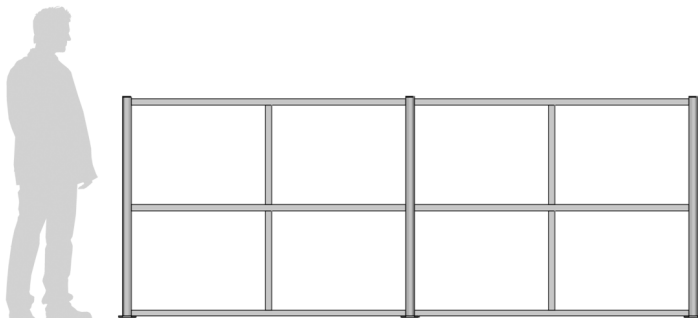

**Model Number** SW13351  
FULL UNIT  
(3 SUPPORT POSTS)

**Model Number** SW13351-2  
FULL UNIT  
(3 SUPPORT POSTS)

### Insert Panel Sizes



Small Square



Medium Rectangular

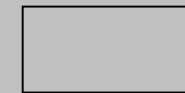

Large Rectangular



## 58" Height Frame Diagrams

Assembly Instructions Start on Page 22

Width	27" w	27" w	51" w	51" w	51" w
Height	58" h	58" h	58" h	58" h	58" h

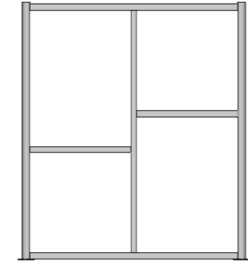
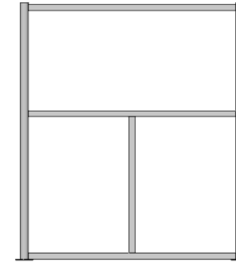
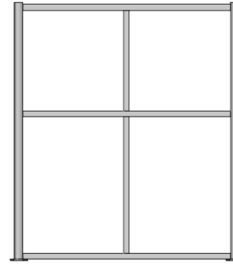
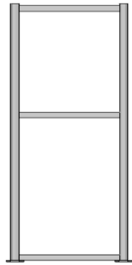

**Model Number** SW2758-1  
FULL UNIT  
(2 SUPPORT POSTS)

**Model Number** SW2758-2  
FULL UNIT  
(2 SUPPORT POSTS)

**Model Number** SW5158-1  
FULL UNIT  
(2 SUPPORT POSTS)

**Model Number** SW5158-2  
FULL UNIT  
(2 SUPPORT POSTS)

**Model Number** SW5158-3  
FULL UNIT  
(2 SUPPORT POSTS)

Width	75" w	75" w	75" w	75" w
Height	58" h	58" h	58" h	58" h

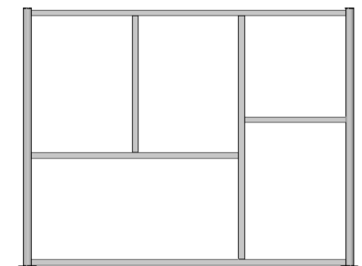
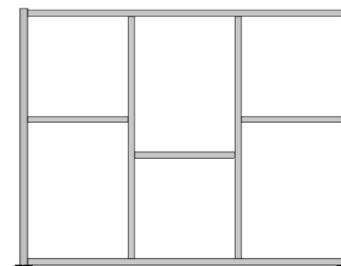
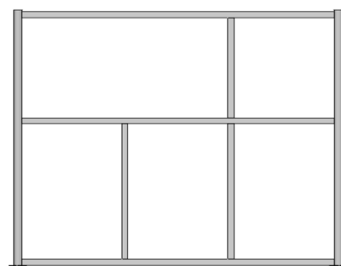
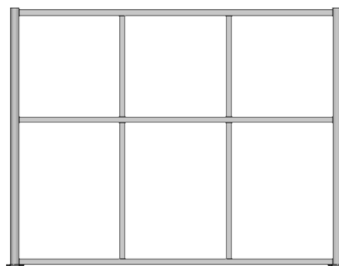

**Model Number** SW7558-1  
FULL UNIT  
(2 SUPPORT POSTS)

**Model Number** SW7558-2  
FULL UNIT  
(2 SUPPORT POSTS)

**Model Number** SW7558-3  
FULL UNIT  
(2 SUPPORT POSTS)

**Model Number** SW7558-4  
FULL UNIT  
(2 SUPPORT POSTS)

## 58" Height Frame Diagrams

Assembly Instructions Start on Page 22

Width 100" w  
Height 58" h

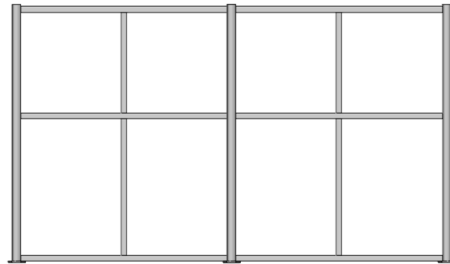

Model Number

**SW10058-1**  
FULL UNIT  
(3 SUPPORT POSTS)

Width 100" w  
Height 58" h

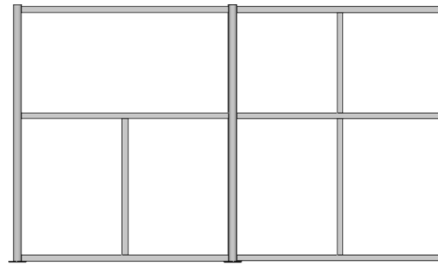

**SW10058-2**  
FULL UNIT  
(3 SUPPORT POSTS)

Width 100" w  
Height 58" h

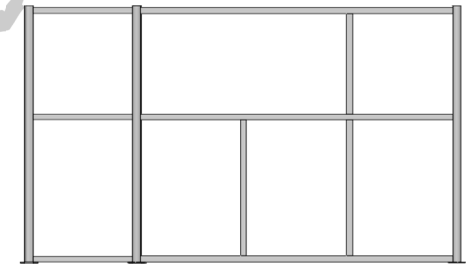

**SW10058-3**  
FULL UNIT  
(3 SUPPORT POSTS)

Width 100" w  
Height 58" h



Model Number

**SW10058-4**  
FULL UNIT  
(3 SUPPORT POSTS)

Width 100" w  
Height 58" h

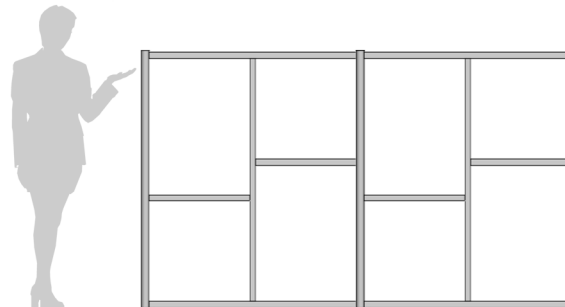

**SW10058-5**  
FULL UNIT  
(3 SUPPORT POSTS)

Width 100" w  
Height 58" h

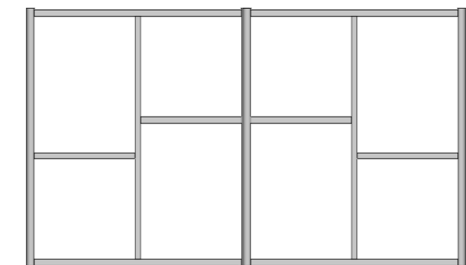

**SW10058-6**  
FULL UNIT  
(3 SUPPORT POSTS)



## 58" Height Frame Diagrams

Assembly Instructions Start on Page 22

Width	124" w	124" w
Height	58" h	58" h

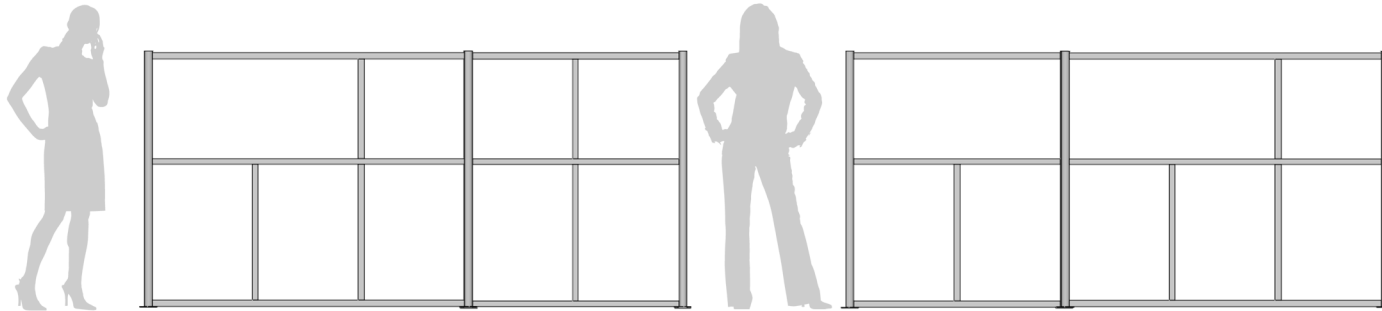

Model Number

**SW12458-1**  
FULL UNIT  
(3 SUPPORT POSTS)

**SW12458-2**  
FULL UNIT  
(3 SUPPORT POSTS)

### Insert Panel Sizes



Small Square



Medium Rectangular

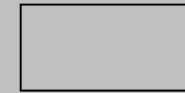

Large Rectangular

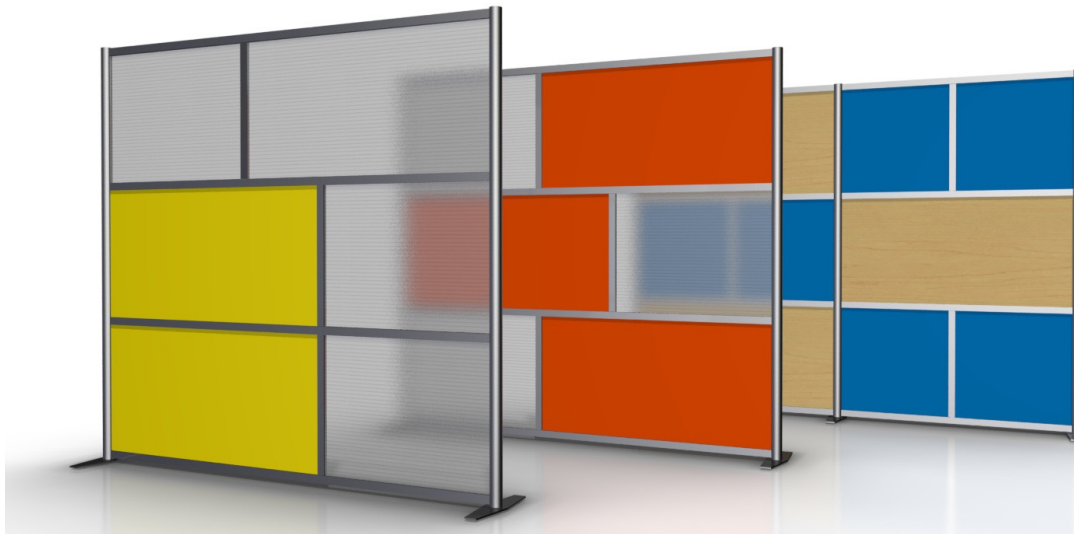

# StudioWall Parts

Quantities and size of each part varies according to model numbers.



Horizontal Frames (Double Slotted or Single Slotted to accept Insert Panels)

## Insert Panel Sizes

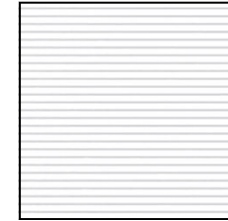

Small Square



Medium Rectangular



Large Rectangular

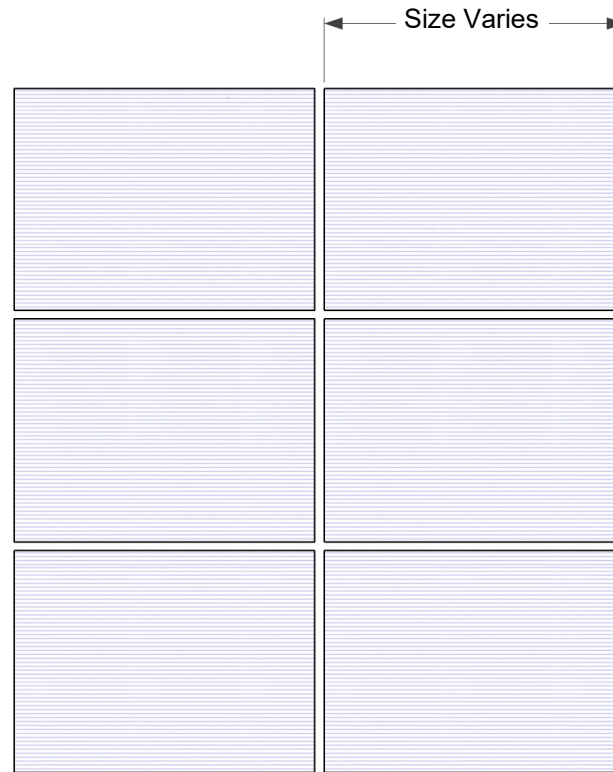

Insert Panels  
(Sizes & Quantities Vary According to Model)

○ ○  
Post Top Caps

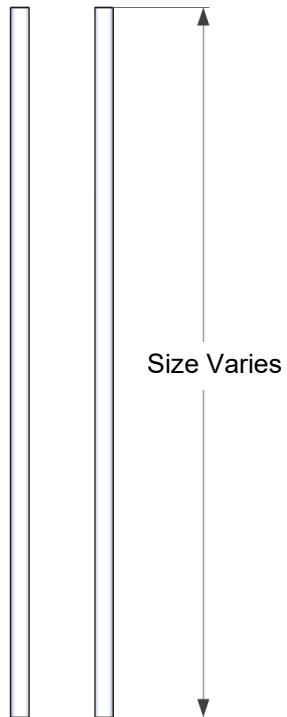

Support Posts with bottom  
Base screw pre-installed

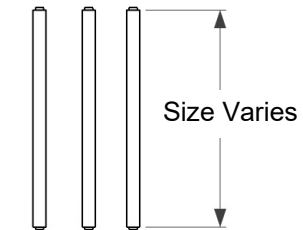

Vertical Frames  
(Double Slotted)



Hex Key Wrenches

Post Support Bases  
Base Screw Pre-Installed  
In bottom of Posts



Bases

# Base & Post Assembly:

Turn clockwise to tighten screw

Pre-Installed Base Stem & screw. Remove screw with Hex Wrench and re-install with base.

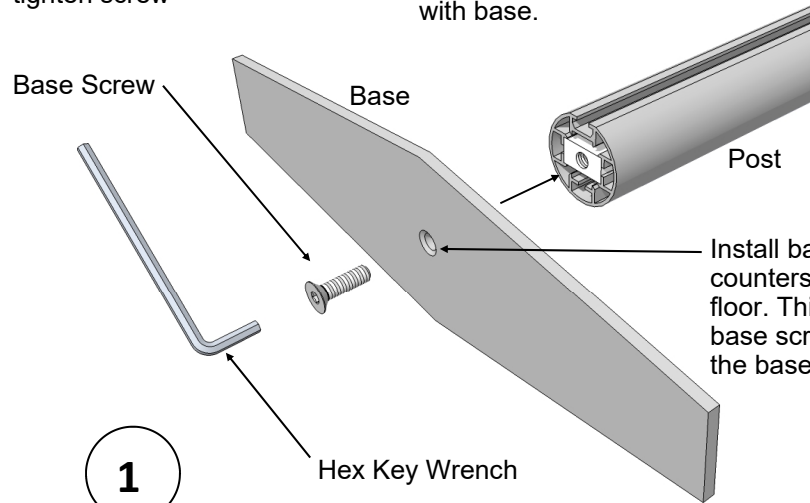

1

Install base with beveled countersunk hole facing the floor. This allows the tapered base screw to be flush with the base bottom

Align orientation of the base with post slot or as needed for specific configuration.

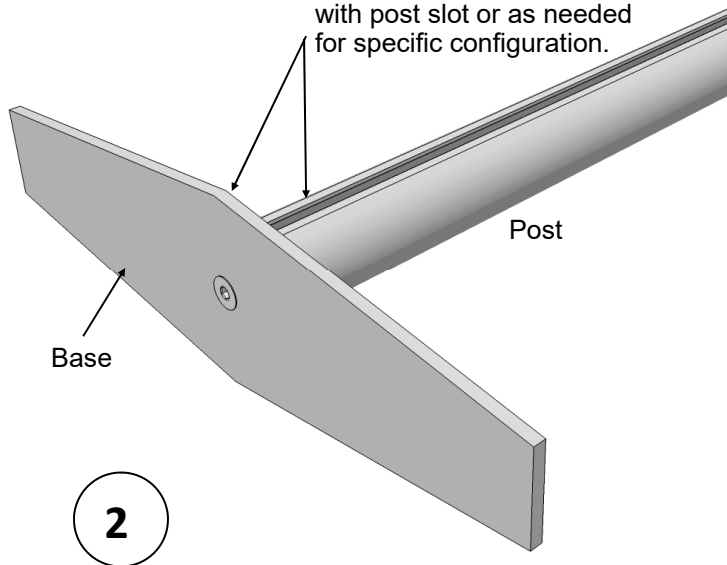

2

3

Align orientation of the base with post slot or as needed for specific configuration.

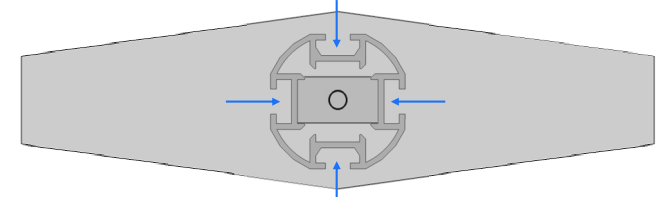
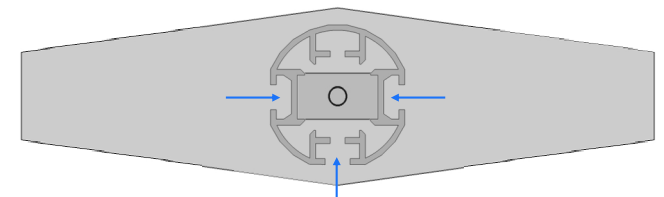
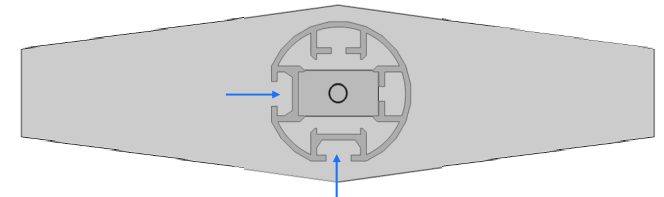
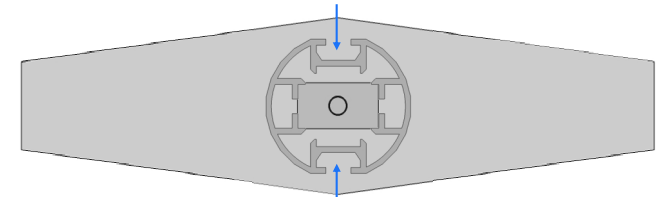
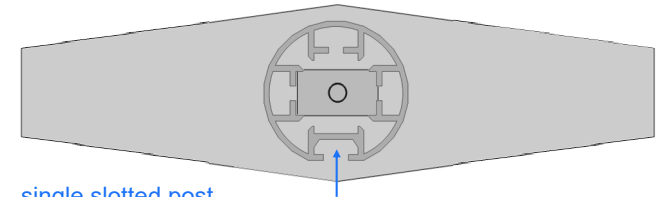

4

REPEAT STEPS FOR THE NEXT POST.

## Frame & Panel Assembly:

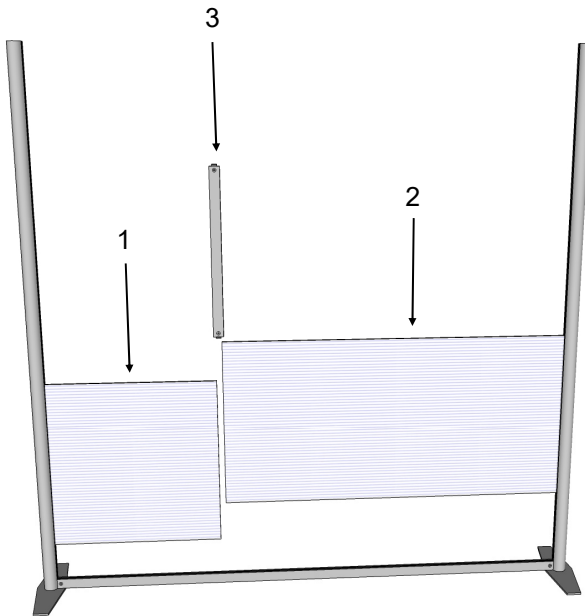
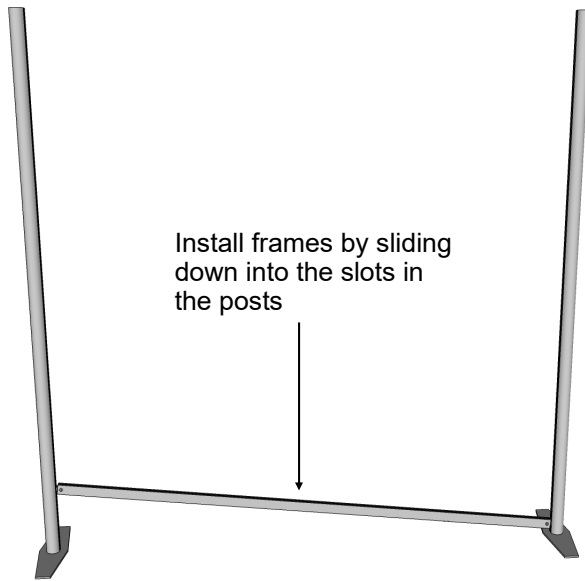

5

Slide panels down with edge inside vertical slots in posts and down into the slots of the horizontal frames.

Remember to peel off the protective film from each side of the panels prior to installation.

Slide vertical frame down between insert panels after panels are in slots.

Repeat steps as described above.

6



Use the supplied hex key wrench to tighten the connector screw at the end of each horizontal & vertical frame

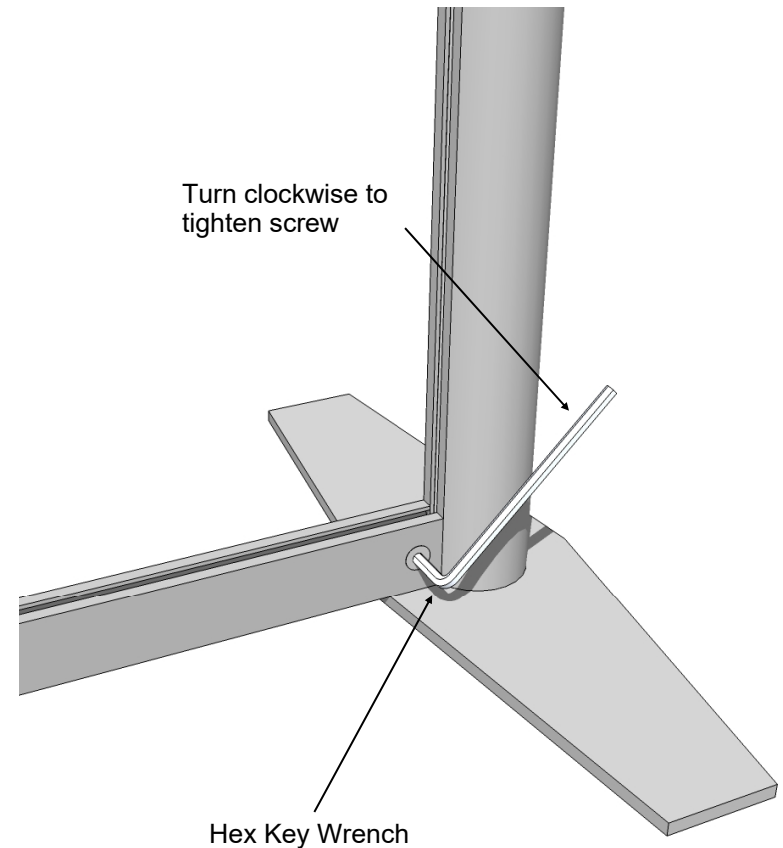



## Frame & Panel Assembly:

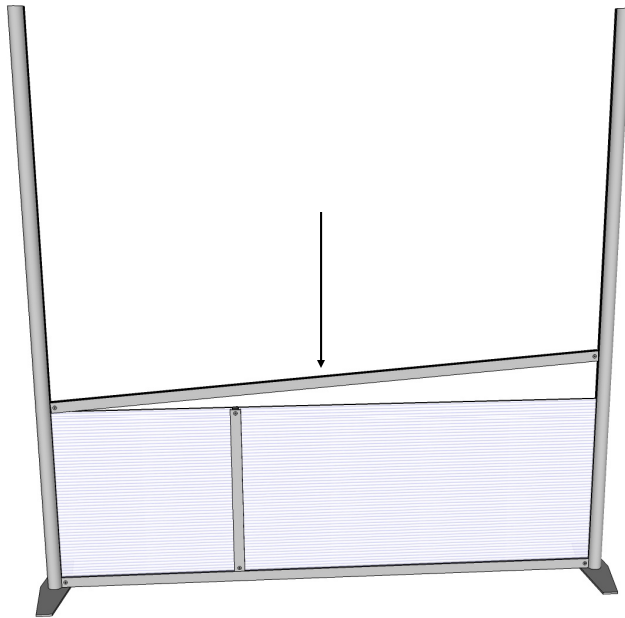

Install vertical frames into the slots of the horizontal frames and tighten the connector screw at each end. See page 24.

Tighten after adjacent panel has been installed.

7

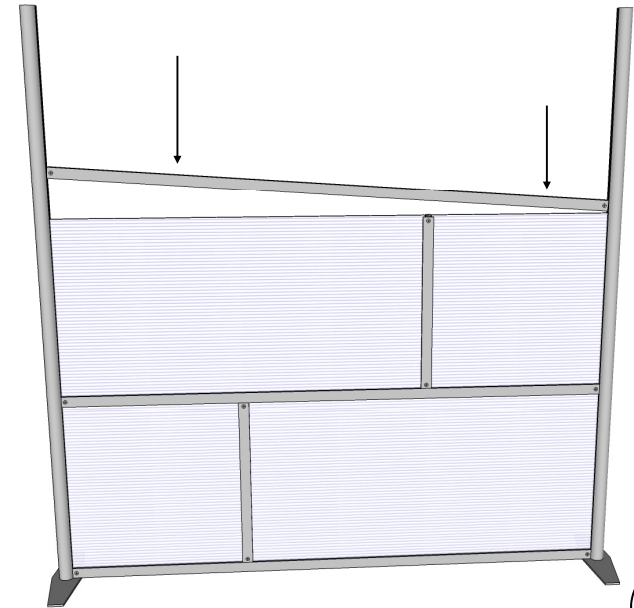

9

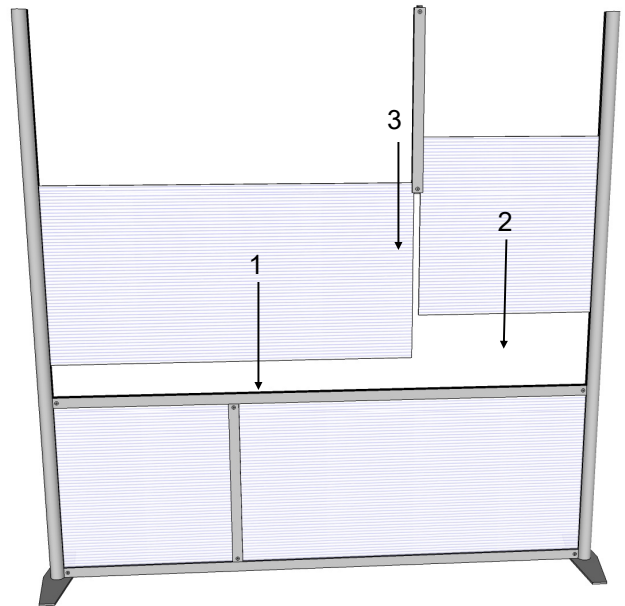

Refer to connection diagram on page 6.

Repeat the process until all the panels and frames are installed.

Press down on horizontal frames to ensure that the panels fit snugly and tighten the connector screws using the hex wrench.

8

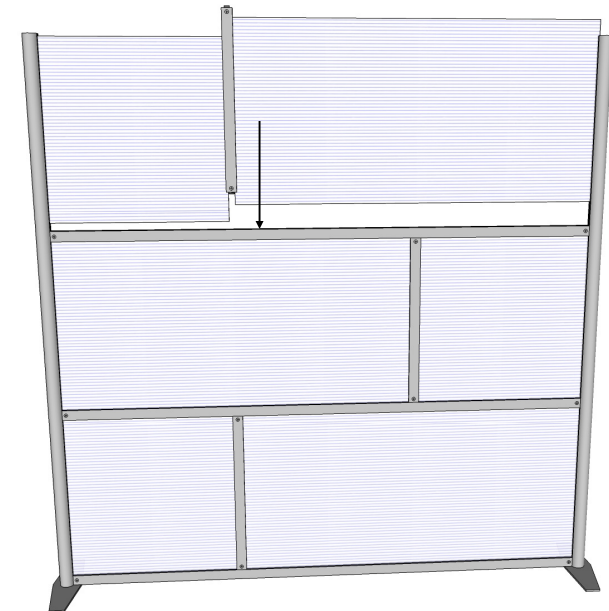

10

## Frame & Panel Assembly:

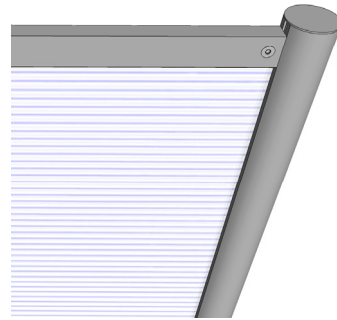
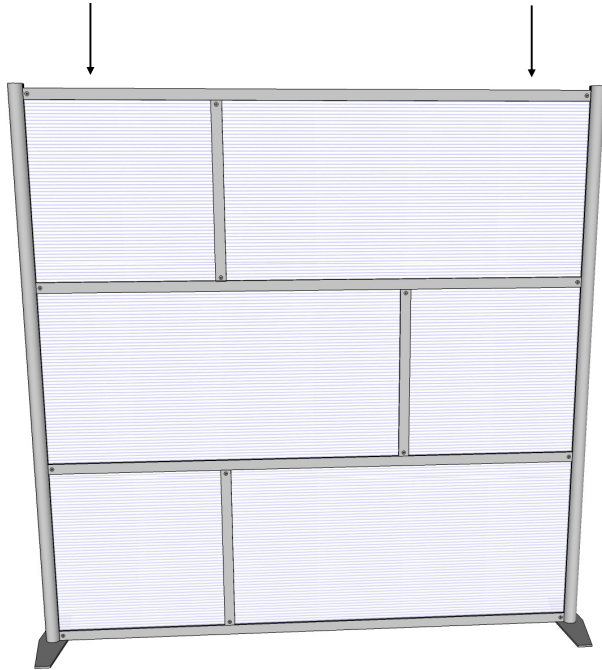

Use Single Slotted Horizontal Frame For Top of all 51" & 58" High Models.

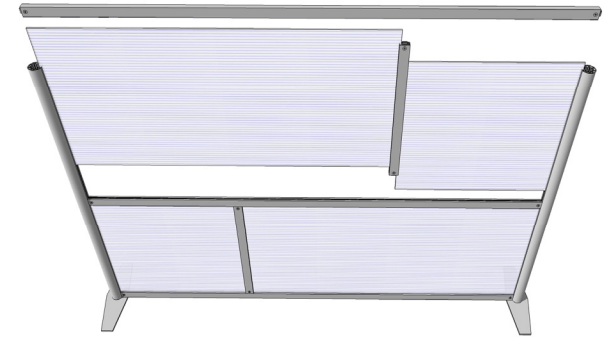

Similar Assembly for 51" & 58" High Models

11

Install Post Caps

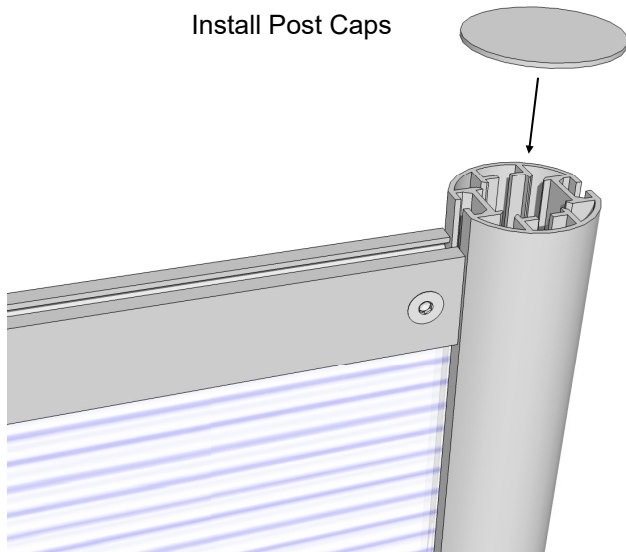

12

Note: Be sure that you spaced the vertical frames exactly as shown in the model configuration diagram(s). Adjustments can be made by loosening the connector screws, measuring, and re-spacing the vertical frames as needed.

Install self-adhesive aluminum post caps last at the top of each post

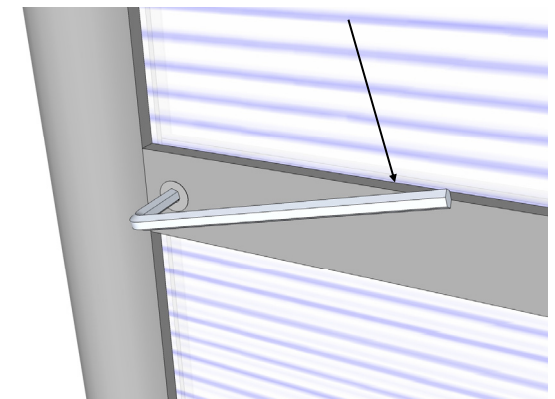
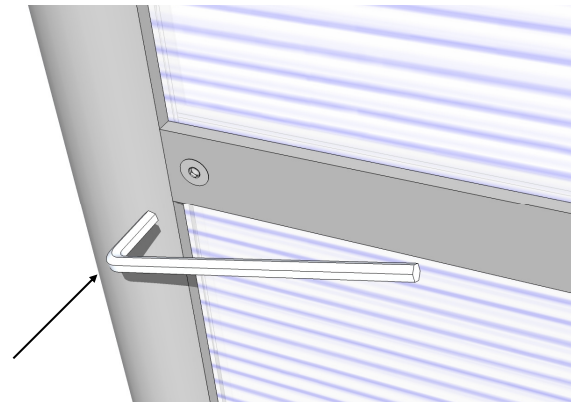

## Frame & Panel Assembly: Add on units and corner returns

Note:

Add on and corner return units assemble using the same method as the straight wall models.

Follow the steps outlined on the previous pages.

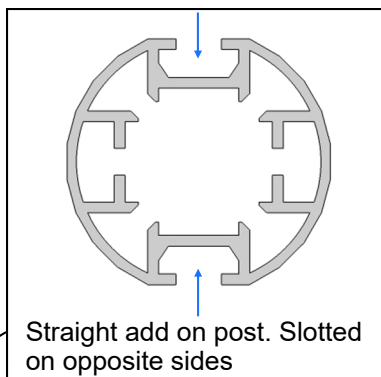
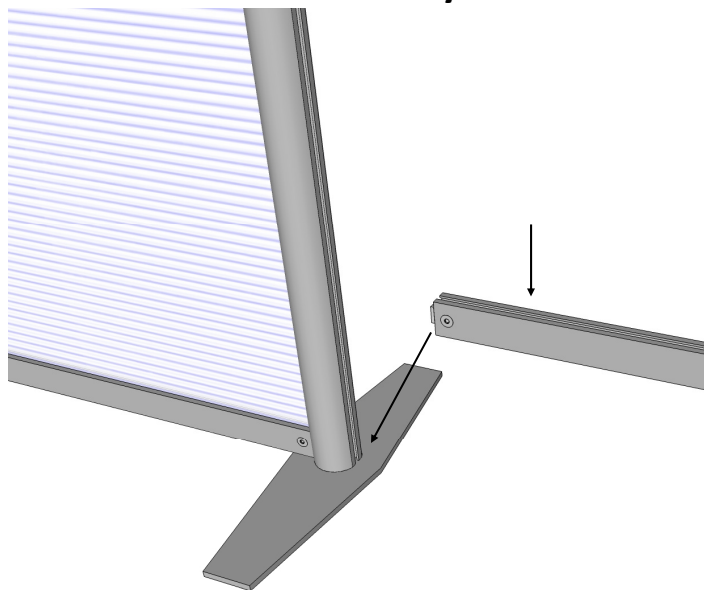

**13**

Use the hex wrench and turn hex screw counter clockwise to tighten connector into the slots.

**14**

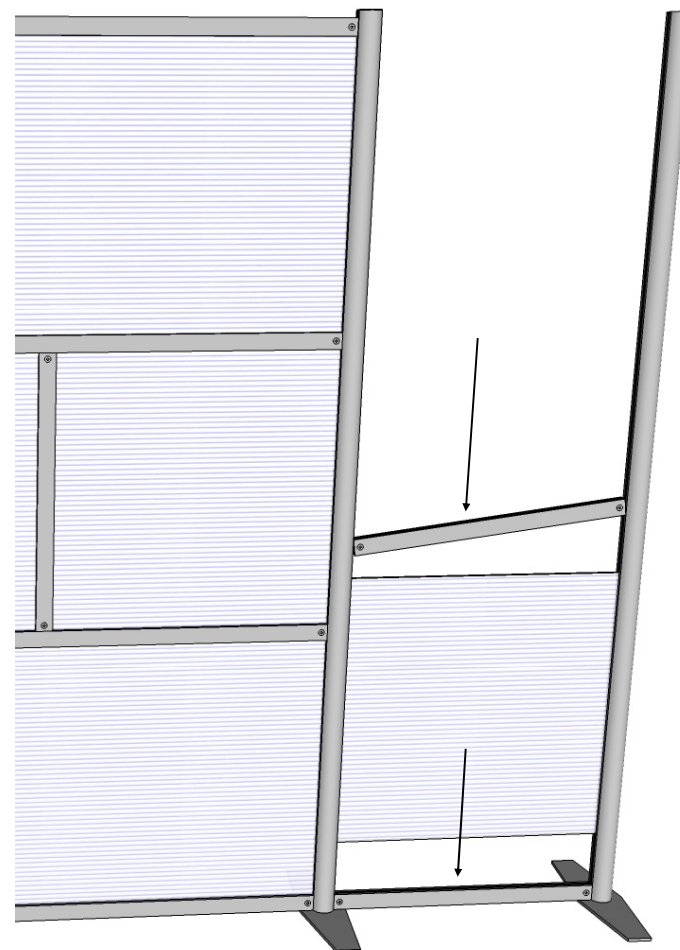
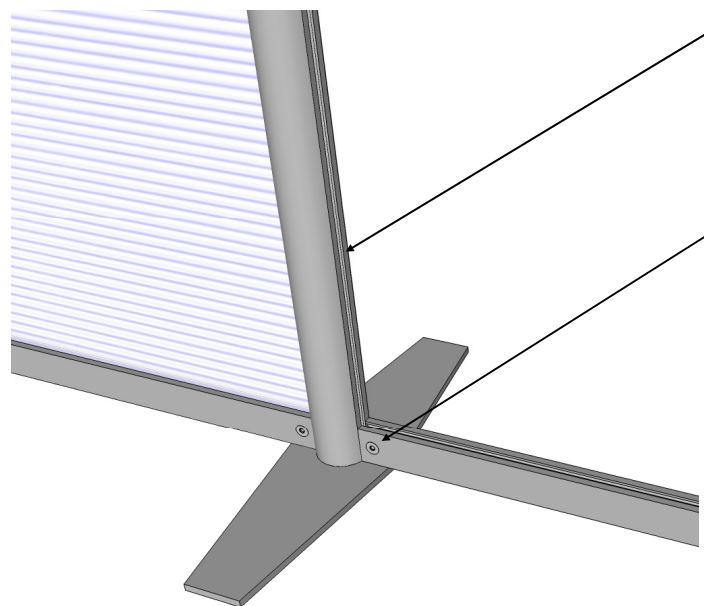

Slide panels down into slots and Install horizontal frames.

## Frame & Panel Assembly: Add on units and corner returns

Note:

Add on and corner return units assemble using the same method as the straight wall models. Follow the steps outlined on the previous pages.

Use the hex wrench and turn hex screw counter clockwise to tighten connector into the slots.

15

90 degree double slotted corner return post.

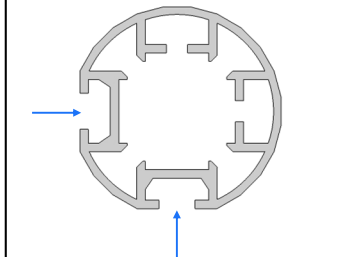

16

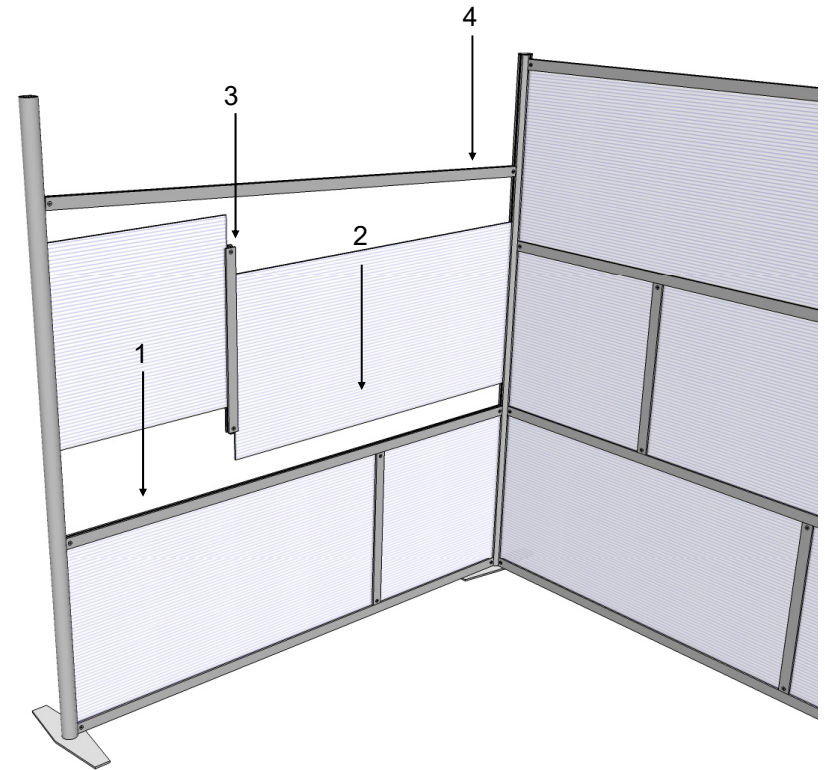

Slide panels down into slots and install horizontal frames.

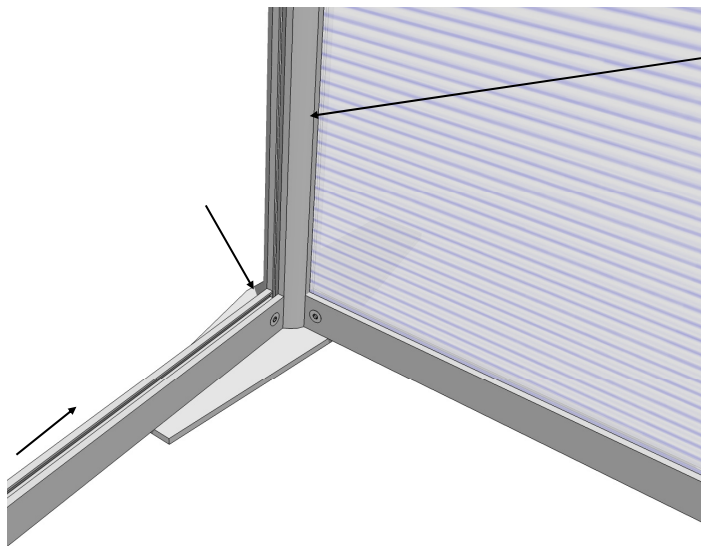

# Details

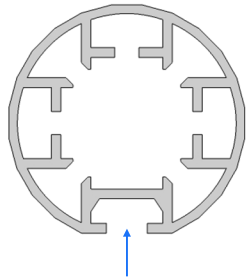

single slotted post

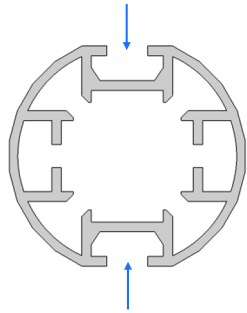

double slotted straight add-on post.

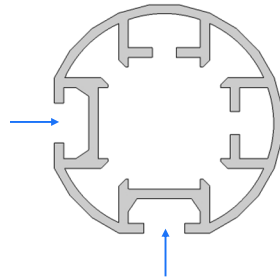

90 degree double slotted corner post.

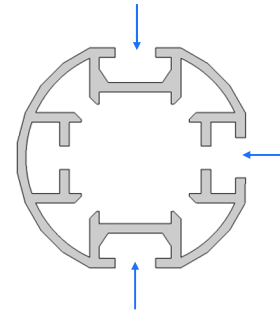

triple slotted corner post for a 3-way connection

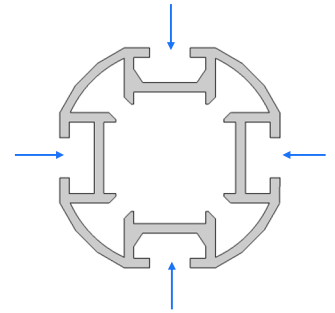

quad slotted corner post for a 4-way connection

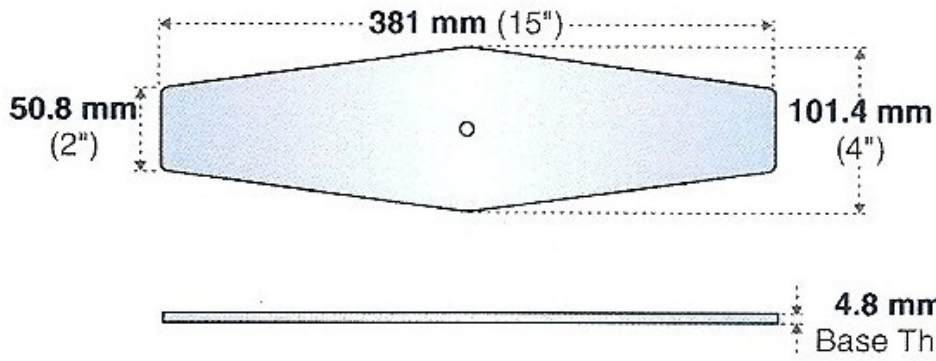

Support Base

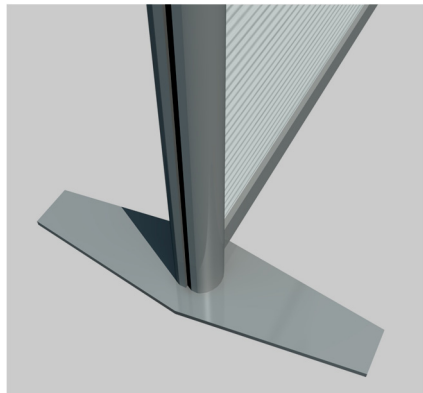

Support Base



Round Vertical Post



Single Slotted Frame



Double Slotted Frame

## Vertical Frame Filler Assembly:

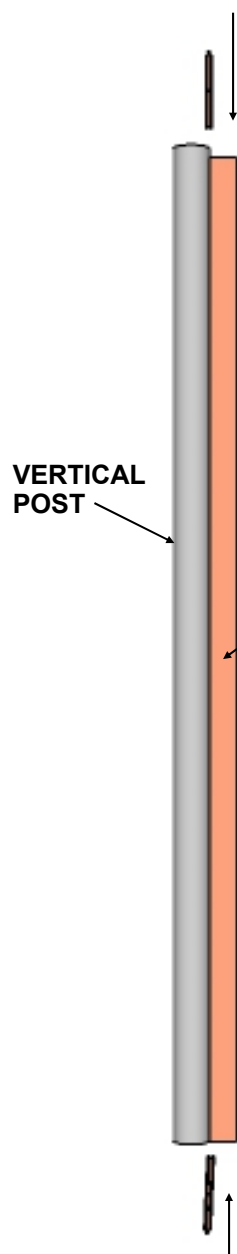

VERTICAL POST

Remove the small washer under the screw in the connector, so that the top can be recessed into the post & frame slots.

Install frame filler connectors by sliding down into the slots in the post and filler frame.

Slide the connector down so it catches the slots in both the post and filler.

VERTICAL FILLER FRAME

Remove the small washer under the screw in the connector, so that the top can be recessed into the post & frame slots.

Install frame filler connectors by sliding down into the slots in the post and filler frame.

Install filler frame flush to bottom of vertical post.

1

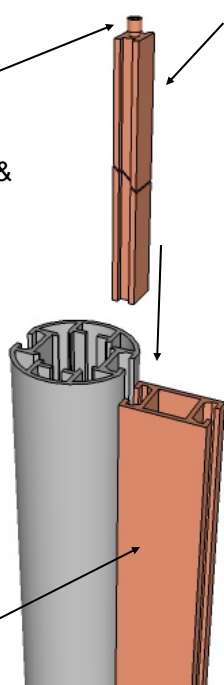

FILLER FRAME CONNECTOR

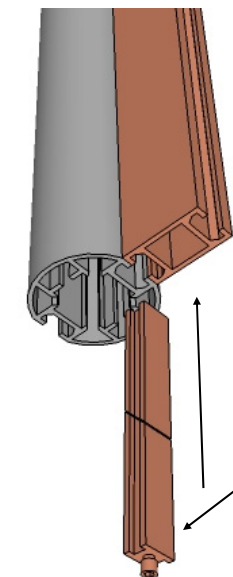

FILLER FRAME CONNECTOR

2

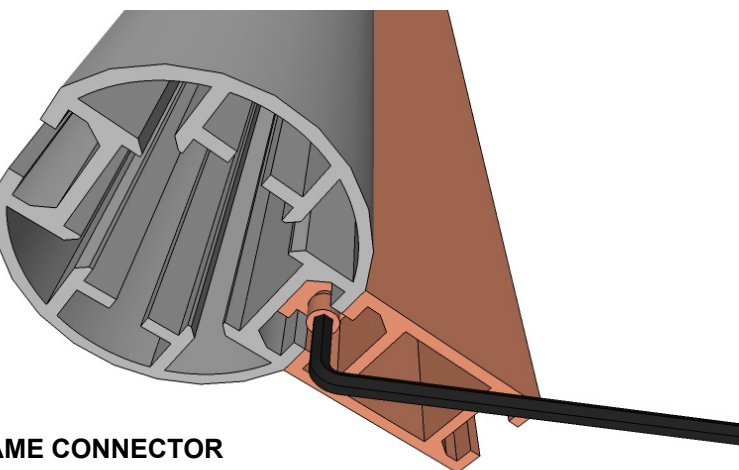

HEX KEY WRENCH

3

Use the supplied hex key wrench to tighten the connector screw at the end of each frame filler connector.

Make sure you removed the washer that may be under the hex screw, so that the top can be recessed below the top and bottom surface of filler.

NOTE: Install rectangular aluminum adhesive caps at top of each filler to finish.

NOTE: Install Filler flush at bottom of vertical post. Connector must be recessed in slot by removing washer.