

Custom Chair Cover - Model 16

Measurement Instructions

- ✓ Provide the right measurements from edge to edge of the furniture
- ✓ Height furniture dimensions provided by you will remain the same

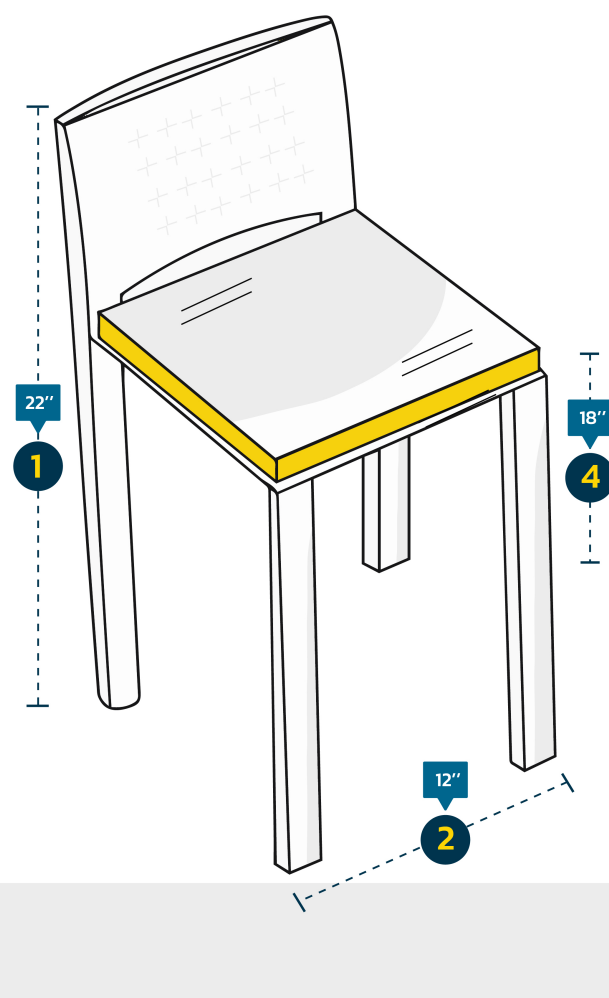

Measurement

(inches)

1. Height _____ 3.Total Depth _____

2. Width _____ 4.Front Height _____

1. Height

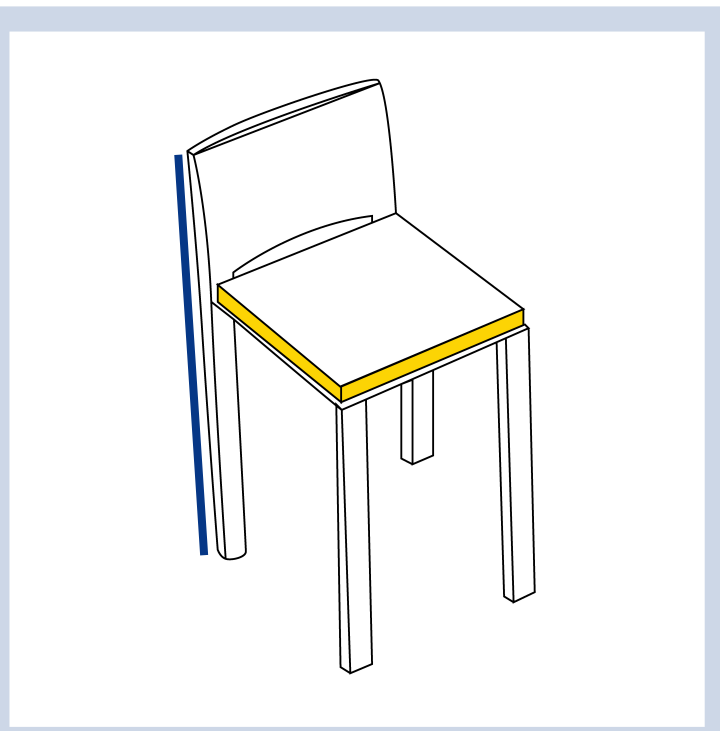

3.Total Depth

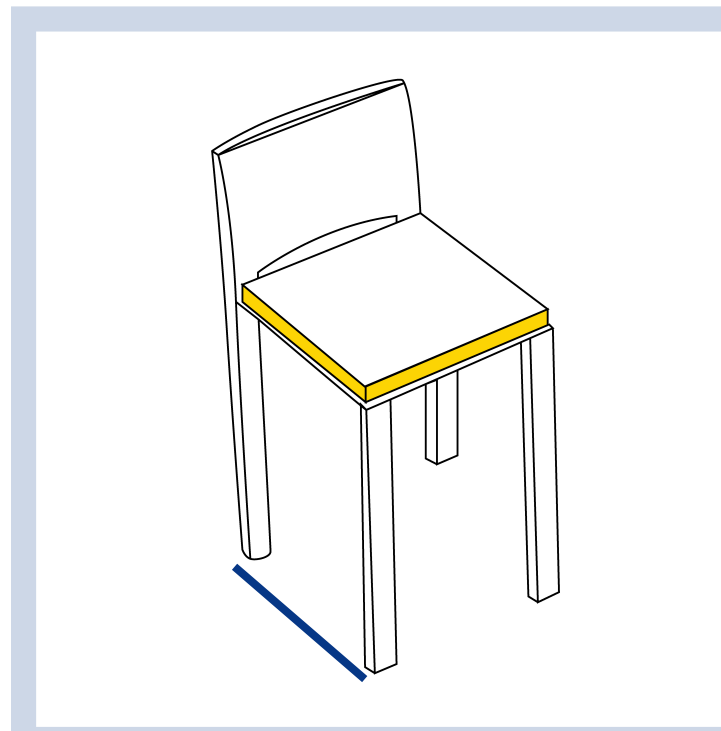

2. Width

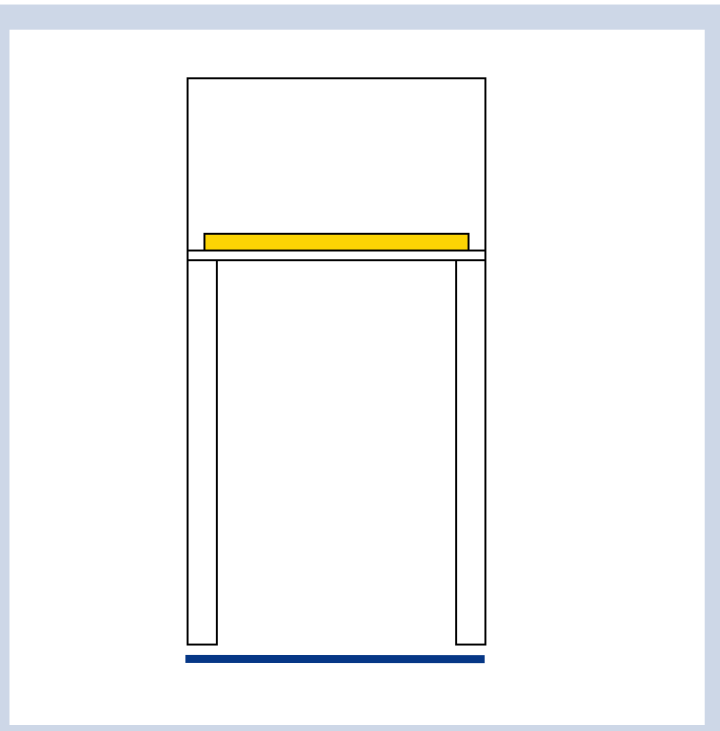

4.Front Height

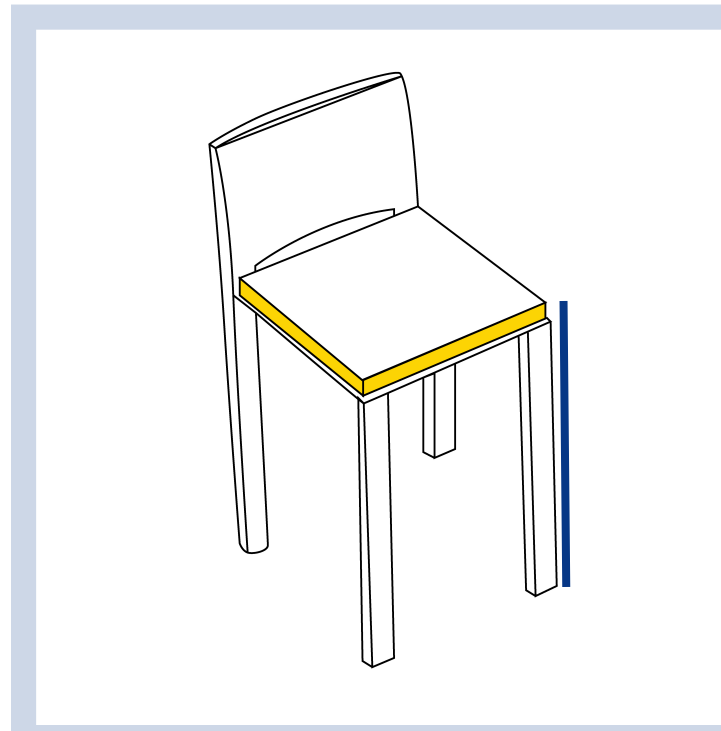

In order for you to get the most out of our extra cover features, we encourage you to upload the right image that you want the cover for, this ensures that our team design the cover that meets your needs!