



COMFORT
THEATRE
BY AMERICAN LEATHER

**YOUR GUIDE TO OPERATING THE
ULTIMATE IN POWER THEATRE SEATING**

AMERICANLEATHER.COM

Congratulations on your purchase of the power
Comfort Theatre[®] by American Leather[®].

Following are helpful hints and important safety
information regarding the use and care of your
Comfort Theatre[®].

Please review this instruction manual thoroughly
before using your power Comfort Theatre[®].

*This product is intended for household/
residential use only.*

IMPORTANT SAFETY INSTRUCTIONS

Read all instructions before using the power Comfort Theatre®.

When using an electrical appliance, basic precautions should always be followed, including the following:

DANGER! To Reduce the Risk of Electric Shock: Always unplug the power Comfort Theatre® from the electrical outlet before cleaning.

WARNING! Risk of Injury: Keep children away from the extended foot support and any moving parts.

CAUTION! Do not allow children to play on this power Comfort Theatre® or operate the power Comfort Theatre® mechanism. The leg rest folds down when closing and could possibly cause injury to a child. Always leave the power Comfort Theatre® in an upright and closed position when not in use. Keep hands and feet clear of mechanism. Only the occupant should operate it.

Safety or Recall Notices:

Register your Comfort Theatre® warranty at americanleather.com. This will ensure that American Leather® can contact you in the event of a safety notice or product recall. Please contact your American Leather® retailer if you did not receive warranty registration information with your power Comfort Theatre®.

POWER CORD SAFETY

WARNING!

UNPLUG AND REMOVE THE POWER CORD FROM THE WALL AND THE POWER SOCKET AT THE REAR OF THE POWER COMFORT THEATRE® WHEN NOT IN USE AND STORE THE CORD OUT OF REACH OF CHILDREN.

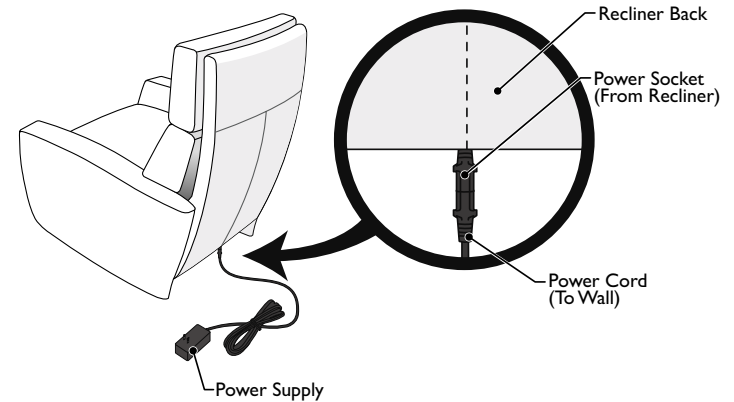

Figure 1

Take care when moving the power Comfort Theatre® that the power cord is not under the legs of the Comfort Theatre®, or it may get damaged. Never operate the power Comfort Theatre® if it has a damaged cord or plug.

IMPORTANT SAFETY INSTRUCTIONS

Footrest Entrapment:

The power Comfort Theatre® has a spring-loaded footrest to prevent entrapment when the power Comfort Theatre® is being closed. In the event that something obstructs the footrest, it will stay partially open via springs located on both sides of the power Comfort Theatre®, even if the motor continues to the fully closed position.

In the Event of an Obstruction:

- Immediately stop the power Comfort Theatre®.
- Carefully open the power Comfort Theatre® and free the obstruction. If necessary, manually pull outward on the spring-loaded footrest and then free the obstruction.

WARNING!

To reduce the risk of burns, fire, electric shock, or injury to persons:

- Use the power Comfort Theatre® only for its intended use as described in this manual.
- Only operate the power Comfort Theatre® when seated.
- Never press or activate the control switch if you are not actually sitting in the power Comfort Theatre®.
- Only the occupant should activate the switch.
- Operation is designed for one person only.
- Never operate the power Comfort Theatre® with more than one person sitting on an individual seat.
- Never sit or stand on the footrest.

- Each power Comfort Theatre® seat can accommodate an occupant of up to 300 pounds maximum.
- Do not race, play with, or abuse the power Comfort Theatre® mechanism.
- Never operate the power Comfort Theatre® if it has a damaged cord or plug, if it is not working properly, if it has been dropped or damaged, or dropped into water.
- Contact your local retailer for examination and repair.
- To unplug the power, return the power Comfort Theatre® to the upright and closed position and then remove plug from the wall outlet or power socket from the rear of the power Comfort Theatre®.
- Unplug from outlet before putting on or taking off parts.
- Close supervision is necessary when the power Comfort Theatre® is used by or near children or disabled persons.
- Keep cord away from heated surfaces.
- Never drop or insert any object into any opening.
- Do not use outdoors.
- Do not operate where aerosol (spray) products are being used or where oxygen is being administered.
- Never operate the power Comfort Theatre® with the air openings blocked. Keep the air openings free of lint, hair, and the like.

IMPORTANT SAFETY INSTRUCTIONS

POWER SUPPLY

Voltage in: 100-120V – 50/60 Hz Lin: 1.2A
Voltage out: 29Vdc Lout: 1.8A
Duty Cycle 2 min ON/20 min OFF
Class 2 Power Supply

Servicing of double-insulated products:

The power Comfort Theatre® is a double-insulated product. In a double-insulated product, two systems of insulation are provided instead of grounding. No grounding means is provided on a double-insulated product, nor is a means for grounding to be added to the product. Servicing a double-insulated product requires extreme care and knowledge of the system, and is to be done only by qualified service personnel. Replacement parts for a double-insulated product must be identical to the parts they replace. A double-insulated product is marked with the words “DOUBLE INSULATION” or “DOUBLE INSULATED.”

The symbol (Square within a square □) is also able to be marked on the product.

BATTERY SAFETY (OPTIONAL):

If battery operation was purchased as an optional accessory to your power Comfort Theatre® there are additional safety instructions to be followed.

DANGER! Risk of Physical Injury:

The power Comfort Theatre® has a control that is located remotely from the battery that must be secured before servicing.

(See Figure 2)

WARNING!

UNPLUG AND REMOVE POWER CORD FROM THE WALL AND FROM THE POWER SOCKET AT THE REAR OF THE POWER COMFORT THEATRE® WHEN NOT IN USE AND STORE OUT OF REACH OF CHILDREN. ALSO, UNPLUG THE MASTER POWER CORD FROM THE CONTROL BOX TO PREVENT USE WHEN A BATTERY IS MOUNTED IN THE COMFORT THEATRE® POWER SYSTEM.

(See Figure 2)

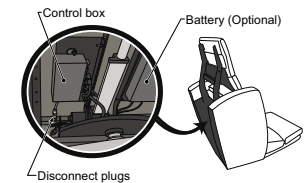

Figure 2

WARNING!

Only use an identical replacement battery supplied by your local American Leather® retailer. The battery is matched to the charging system in the power Comfort Theatre®. Use of a non-identical battery could cause risk of burns, fire, electric shock, or injury to persons.

Replacement batteries can be ordered from your local American Leather® retailer.

- **Do not** use a non-rechargeable battery
- **Do not** mix old and new batteries
- **Do not** mix non-rechargeable and rechargeable batteries
- Use only one battery – **Do not** chain batteries together

USER MAINTENANCE INSTRUCTIONS

Unplug the outlet cord before cleaning the power Comfort Theatre®.

If the power Comfort Theatre® is equipped with an optional battery, also unplug the master power cord from the control box before cleaning or performing maintenance.

(See Figure 2)

Do not use any liquids or spray cleaners on any electrical components.

Follow the cleaning code located on the swatch label under the footrest or in your warranty booklet to clean the upholstery cover.

It is not necessary to lubricate any components of the power Comfort Theatre®.

None of the electrical components are user-serviceable. Any other servicing should be performed by an authorized service representative.

If the power cables or transformer are ever damaged, they can be ordered from your American Leather® retailer.

OVERLOAD PROTECTION

The power Comfort Theatre® has both electronic and thermal overload protection. If the weight limit of the power Comfort Theatre® is substantially exceeded or an obstruction keeps

the power Comfort Theatre® from being able to open or close, an electronic overload sensor will prevent the motor from operating. In addition, the transformer is equipped with a thermal fuse. If the motor or transformer is overworked, this thermal fuse is tripped, which shuts off the motor and transformer. The thermal fuse will automatically reset in 10-15 minutes after the transformer has cooled down. The power Comfort Theatre® may then be used normally.

STORAGE

If the power Comfort Theatre® will not be used for an extended period of time, remove the power cord from the power socket and wall outlet and store the cord out of reach of children. If the power Comfort Theatre® is equipped with an optional battery, also unplug the master power cord from the control box.

Store the power Comfort Theatre® in a dry interior location.

SAVE THESE INSTRUCTIONS

Comfort Theatre®

by American Leather®

YOUR GUIDE TO OPERATING THE ULTIMATE POWER THEATRE

CONTROL PANEL ATTACHED TO SEATING

Operating Control Panel:

The control buttons are backlit with LED lights that turn on automatically when a button is touched, and will turn off automatically about 4-5 seconds later. (See Figure 3)

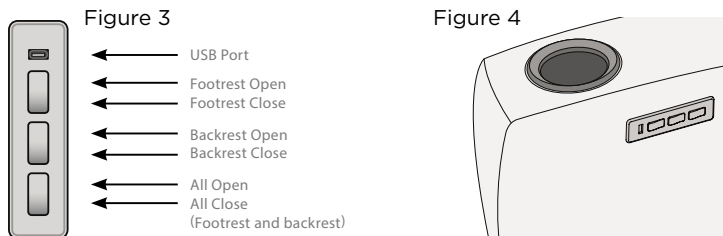

The optional LED lighted cup holder is operated by touching the metal cup twice to turn on or off. The light will shut off automatically after approximately 10 minutes. (See Figure 4)

FOOTREST & BACK RECLINE

The footrest has infinite stopping positions, independent from the power Comfort Theatre® back recline. To raise the footrest, press the raised area of the front toggle switch located next to the USB port. If you are sitting in the power Comfort Theatre®, this is the farthest button from the backrest. Simply release the button to stop the footrest in any position. To close, press the rear area of the same toggle switch. (See Figure 3)

The back recline also has infinite stopping positions, independent from the footrest. To recline the backrest, press the raised area of the middle toggle switch. When you have reached your desired position, simply release the button to stop the backrest in any position. To close, press the rear area of the same toggle switch.

To open both the footrest and the backrest at the same time, press the raised area of the third toggle switch. To close both footrest and backrest at the same time, press the rear area of the third button closest to the backrest. This button will close the footrest and return the backrest to the full upright position.

ADJUSTING HEADREST

The Comfort Theatre® headrest adjusts to provide back and neck support. The headrest articulates forward to create the perfect angle for watching television. When standing behind the power Comfort Theatre®, you can change the angle by pressing forward on the outside of the headrest. However, if you are already sitting and want to adjust the angle, place both hands on the back of the headrest and pull forward to your desired position. To return the articulating headrest to its normal position, simply push back with your hands.

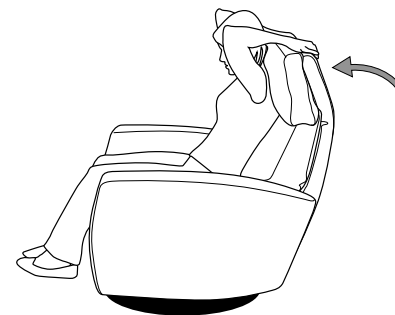

OPTIONAL BATTERY POWER

The purchase of the optional battery for use in the power Comfort Theatre® allows the power Comfort Theatre® to be operated either with the cord plugged into the wall, or with battery power only. This allows you to float the power Comfort Theatre® in the room without cords attached.

Battery Life:

The optional battery is a 1.8 Amp hour Lithium Ion (1.8 A/h Li-ion) battery in a fully enclosed case. The minimum life expectancy of the battery is 500 complete charge/ discharge cycles.

A fully charged battery will provide about 100 complete open/close cycles before it needs to be recharged.

When the battery needs charging the power Comfort Theatre® will begin to operate more slowly, indicating the battery is running out. If the battery gets to about 10% of capacity, a beeping tone will sound when any of the control buttons are pressed, indicating that the power Comfort Theatre® needs to be recharged immediately.

Please note that for optimal battery life, the battery should not be used to its capacity, or used until the power Comfort Theatre® stops working. It is recommended that the battery be charged once per month if it is not going to be used for an extended period of time.

Battery Recharging:

To recharge the battery in the power Comfort Theatre®, plug the cord from the power supply into the power socket at the rear of the power Comfort Theatre® and then plug the power supply into an electrical outlet as shown in *Figure 5*.

The power system has an automatic power selector system that chooses battery power or power from the wall outlet, depending on whether the power Comfort Theatre® is plugged in or not.

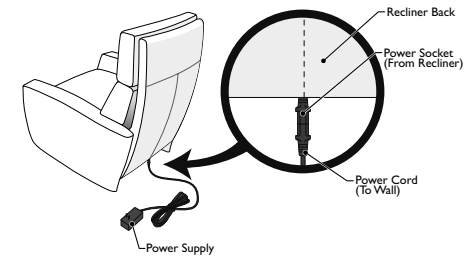

Figure 5

If the power Comfort Theatre® is plugged in for recharging, the automatic power selector system will provide power to charge the battery and operate the power Comfort Theatre® at the same time.

If the cord is plugged into the power Comfort Theatre® continuously, the system will not overcharge the battery.

The charging time for the battery is about eight hours.

To determine if the battery is done charging, open the footrest and look under the power Comfort Theatre® footrest at the battery. The **LED** light on the battery will be a solid **GREEN** if it is fully charged and flashing **AMBER** if it is still charging.

Battery Replacement Instructions (OPTIONAL):

*Your power Comfort Theatre® may be equipped with optional battery power. Follow the instructions below for the power Comfort Theatre® that are equipped with this feature.

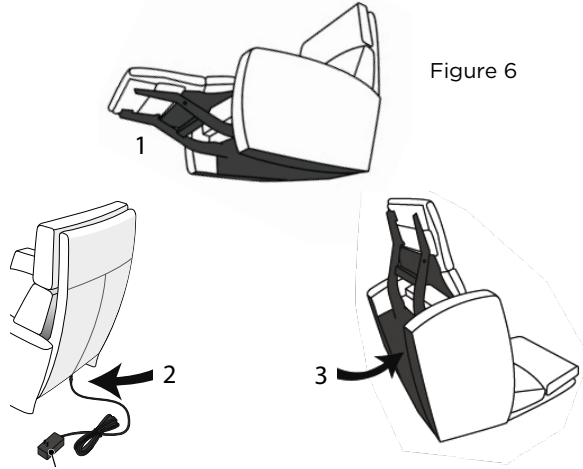

In the event that the battery needs to be replaced:
(See Figure 6)

1. Fully open (extend) the footrest and the backrest of the power Comfort Theatre®.
2. Unplug the power socket from the rear of the power Comfort Theatre®.
3. Tip the power Comfort Theatre® onto its back as shown in Figure 6. Because of the power Comfort Theatre® weight and size, a second person is recommended to assist in this task.

4. Locate the battery to the right of the motor.
(See Figure 7)

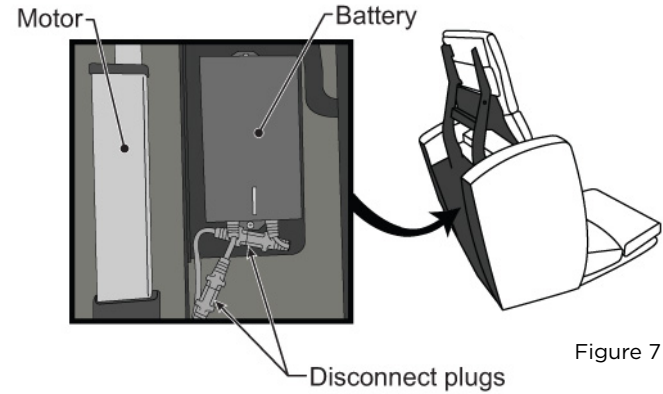

5. Disconnect both battery cord plugs. (See figure 7)
6. Remove the two screws holding the battery to the tray.
(See Figure 8)

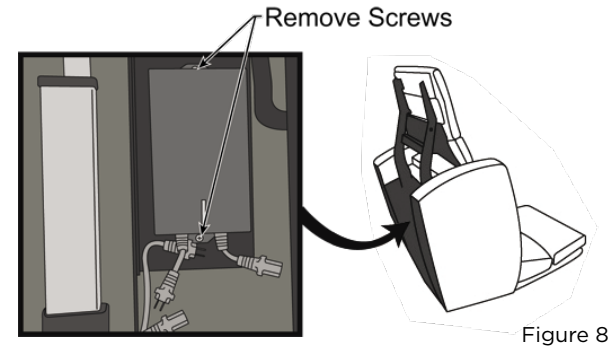

7. Remove battery from the power Comfort Theatre[®].
8. Install new battery with two screws, plug both cords into the connector cords.
(Assembly should look like Figure 7)
9. Place the power Comfort Theatre[®] in the upright position and plug the cord back into the power socket at the back of the power Comfort Theatre[®]. Then plug the other end of the power cord into the wall outlet.
10. Look under the footrest at the battery; the LED at the front of the battery will be flashing AMBER when it is charging and solid GREEN when it is fully charged. Let the new battery charge up overnight. The power Comfort Theatre[®] can be used normally when it is plugged in and the battery is charging.

We know you will enjoy your Comfort Theatre[®] by American Leather[®] and thank you for your purchase. Register your Comfort Theatre[®] warranty at americanleather.com.

**DESIGNED &
DELIVERED**
TO YOUR HOME IN
30 DAYS

**AMERICAN
LEATHER**

AMERICANLEATHER.COM

V12.2018