

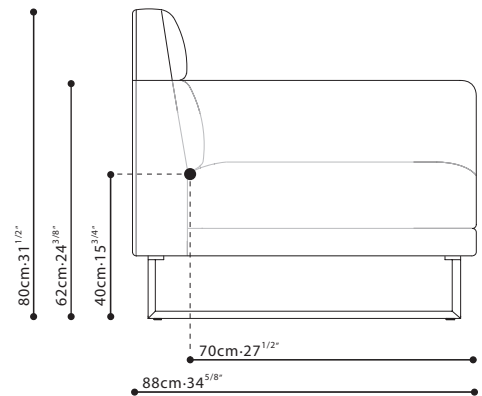

AMOR / FRAME: Solid Birch ,covered w/fabric lined polyurethane foam. SEAT: Cross-woven elastic webbing & sinuous springs supporting seat cushions consisting of high-resilient variable-density polyurethane foam. PILLOWS: Feather down filled. BASE: Black painted die-cast steel w/plastic glides. UPHOLSTERY: Non-removable fabric or leather

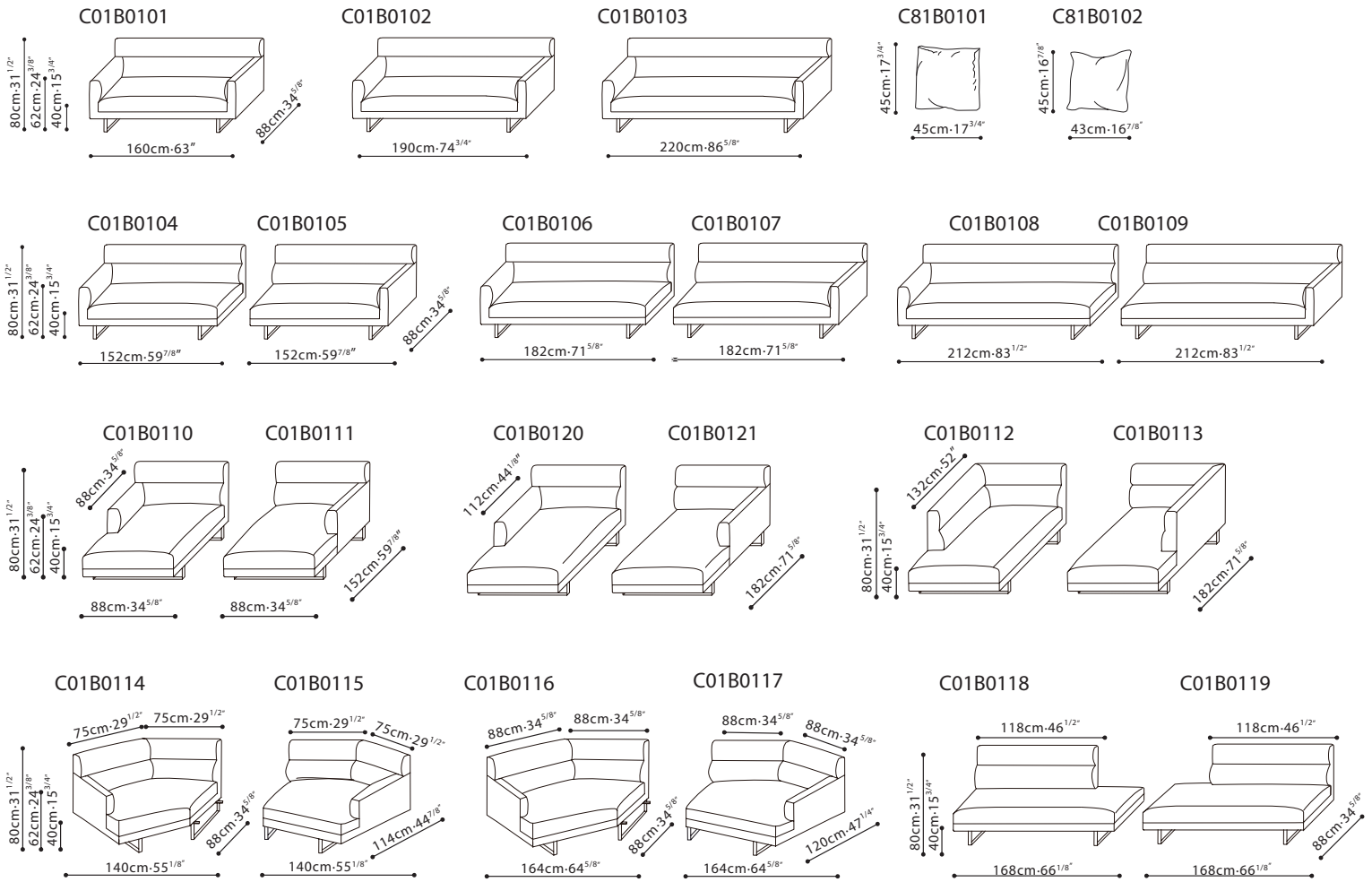

FABRIC VERSION



LEATHER VERSION

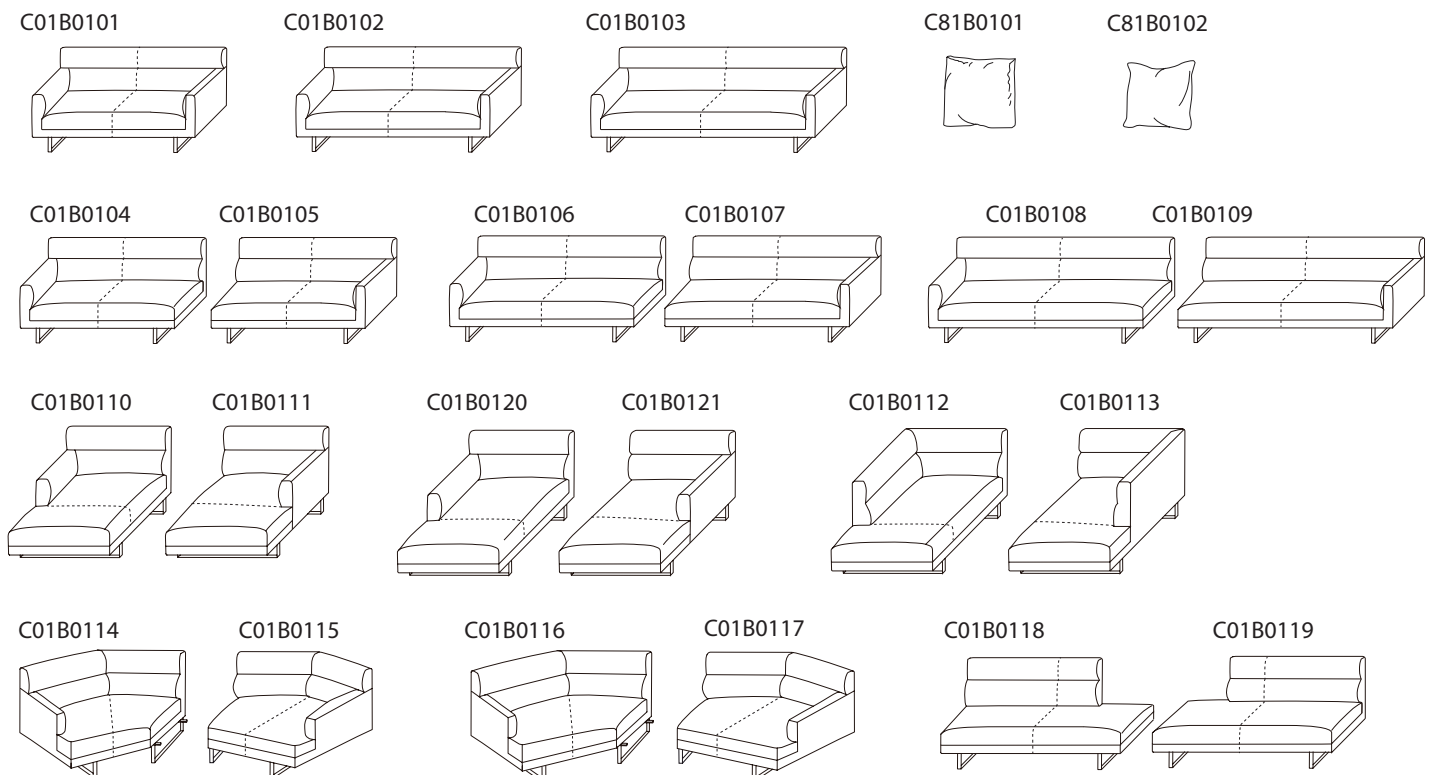

(dotted lines illustrate positioning of stitched seams on leather versions of this sofa)

RECOMMENDED CUSHIONS

Item Code	Recommended Cushions
C01B0101	C81B0101*2, and C81B0102*1
C01B0102	C81B0101*2, and C81B0102*1
C01B0103	C81B0101*2, and C81B0102*1
C01B0104/05	C81B0102*1, and C81B0101*1
C01B0106/07	C81B0101*2, and C81B0102*1
C01B0108/09	C81B0101*2, and C81B0102*1
C01B0110/11	C81B0101*1, and C81B0102*1
C01B0112/13	C81B0101*2, and C81B0102*1
C01B0114/15	C81B0101*1, and C81B0102*1
C01B0116/17	C81B0101*2, and C81B0102*1
C01B0118/19	C81B0101*1
C01B0120/21	C81B0101*1, and C81B0102*1

SAMPLE CONFIGURATION

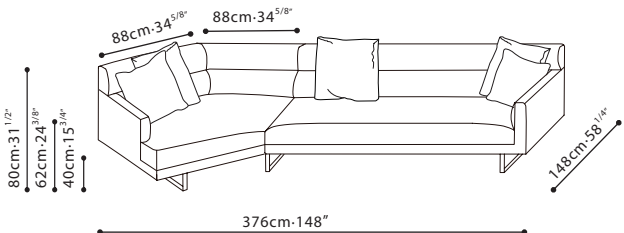

C01B0116+C01B0109+C81B0101×3+C81B0102×2

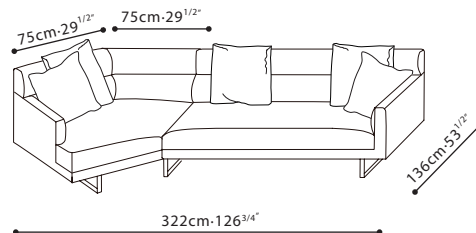

C01B0114+C01B0107+C81B0101×3+C81B0102×2

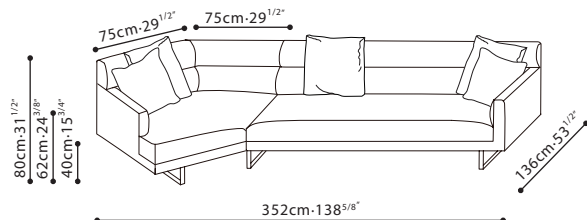

C01B0114+C01B0109+C81B0101×3+C81B0102×2

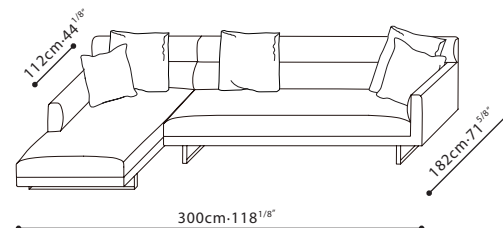

C01B0120+C01B0109+C81B0101×3+C81B0102×2

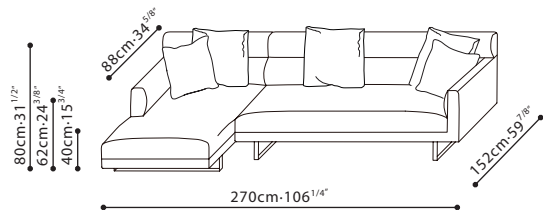

C01B0110+C01B0107+C81B0101×3+C81B0102×2

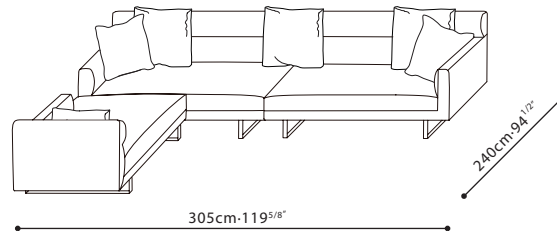

C01B0111+C01B0104+C01B0105+C81B0101×4+C81B0102×2

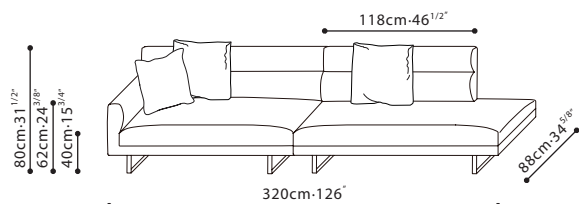

C01B0104+C01B0118+C81B0101×2+C81B0102