

## Visual Selection Guide

### **ROBOHAND** | Grippers, Slides, Rotaries



# ABOUT DESTACO

Built on a Strong Foundation

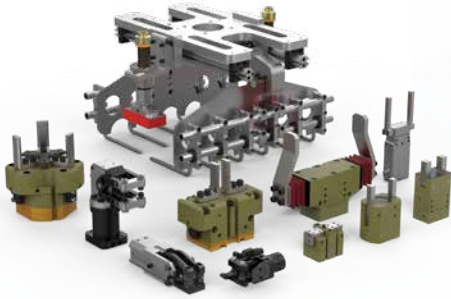

Gripping Solutions



Linear Positioning Solutions



Rotary Positioning Solutions



Clamping Solutions



CRL Remote Handling Solutions



Robotic Tooling Solutions

DESTACO, a Dover company, is a global leader in the design and manufacture of high-performance automation, workholding and remote-handling solutions. The company serves customers in a variety of end-markets, including the automotive, life sciences, consumer packaged goods, aerospace, industrial and nuclear sectors.

Built on a legacy of more than 100 years, DESTACO offers a comprehensive portfolio of products designed to engineer precise movement, placement and control solutions that drive productivity and uptime for manufacturers around the world. The DESTACO family of products consists of industry-leading brands such as DESTACO Manual Clamps, Power Clamps, and End Effectors; CAMCO™ and Ferguson™ Indexers; Robohand™ Grippers; and CRL™ Manipulators and Transfer Ports.

DESTACO is based in Auburn Hills, Michigan, U.S.A. The company has more than 800 employees with 13 locations, in 9 countries, across the Americas, Europe and Asia.

DESTACO is part of Dover Corporation, a diversified global manufacturer with annual revenues of \$7 billion. The company delivers innovative equipment and components, specialty systems and support services through four major operating segments: Energy, Engineered Systems, Fluids, and Refrigeration & Food Equipment. Headquartered in Downers Grove, IL, (NYSE: DOV)

More information is available at [destaco.com](http://destaco.com) and [dovercorporation.com](http://dovercorporation.com)



## Focusing all our Resources

### New Product Development

Destaco has dedicated resources to design and build the next generation of products and solutions

### Customer Service and Technical Support

Destaco has industry leading global support to address any product and application concerns you may have

### Design Tools

Destaco provides an extensive CAD library, sizing software, and online tools to support our global customers



## Our Insight Working for You

### Application Engineering

We utilize our expertise and complete portfolio of products to create solutions that fit our customers' needs and applications

### Custom Solutions

if our off-the-shelf solutions don't fit, we will partner with our customers to develop products that will



## Grippers, Rotaries, and Linear Slide Solutions

### Engineered Reliability

Destaco's Robohand products are engineered for reliability and long life to ensure maximum production uptime. These products are designed and machined for precise repeatability with minimal maintenance.

#### Markets



#### Applications

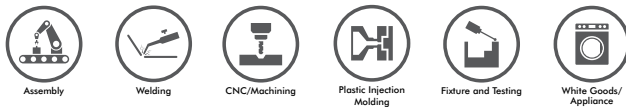

# GRIPPERS/SLIDES/ROTARIES

CLICK OR SCAN

To view the full  
PDF catalog on  
these products



## Table of Contents

### Introduction:

Clean Room Solutions.....	5
Modular Mounting Solutions/DirectConnect™ .....	6
North American Xpress Program .....	11
European Xpress Program .....	12
Product Sizing and Application Charts .....	14



OEM Machine Builder Products ..... 34



Electric Grippers ..... 40



Precision Grippers ..... 42



General Industrial Grippers ..... 54



Heavy Duty Grippers ..... 74



3-Jaw Parallel Grippers ..... 82



Angular Grippers..... 92



Specialty Grippers ..... 100



Rotary Actuators ..... 102



Linear Slides..... 112



Feed Escapements..... 128

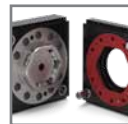

Robotic Tooling Solutions ..... 132

# CLEAN ROOM RATED SOLUTIONS

## Grippers/Slides/Rotaries | Product Overview

Destaco's Clean Room Rated Solutions are geared toward laboratory, semiconductor, medical, and food handling type environments. Many of our pneumatic products include a scavenge or purge port. These extra ports create internal vacuum or pressure to control contaminants escaping into the environment or prevent de-greaser or other chemicals penetrating our product.

### Solutions include:

- Diverse line-up of products for class 10/100 cleanroom environments
- Manufactured with corrosion-resistant materials for use with de-ionized water
- Customized solutions available with food and medical grade lubricants, stainless steel, and nickel-plated materials to meet your application requirements.

Rating	Electric Parallel Grippers		
	RPE-100	DPE-200	DPE-400
ISO 4 (Class10)	☉☉		
ISO 5 (Class100)	☉		☉
ISO 6 (Class1,000)	☉	☉	☉
ISO 7 (Class10,000)	☉	☉	☉
ISO 8 (Class100,000)	☉	☉	☉

Rating	Pneumatic 2-Jaw and 3-Jaw Grippers									
	RPMC	RPLC	DPDS	DPDL	DPG	DPP	RDH	RTH	DCT	
ISO 4 (Class10)	☉☉	☉☉	☉☉							
ISO 5 (Class100)	☉☉	☉☉	☉☉	☉☉	☉		☉☉	☉☉		☉
ISO 6 (Class1,000)	☉☉	☉☉	☉	☉	☉		☉	☉		☉
ISO 7 (Class10,000)	☉	☉	☉	☉	☉	☉	☉	☉	☉	☉
ISO 8 (Class100,000)	☉	☉	☉	☉	☉	☉	☉	☉	☉	☉

Rating	Rotary Actuators		
	DRG	DRF	RR
ISO 4 (Class10)			
ISO 5 (Class100)	☉	☉	
ISO 6 (Class1,000)	☉	☉	
ISO 7 (Class10,000)	☉	☉	
ISO 8 (Class100,000)	☉	☉	☉

Rating	Linear Slides		
	DLB	DLT	DLM
ISO 4 (Class10)			
ISO 5 (Class100)			
ISO 6 (Class1,000)	☉	☉	☉
ISO 7 (Class10,000)	☉	☉	☉
ISO 8 (Class100,000)	☉	☉	☉

☉	Standard Clean Room
☉☉	With use of Scavenge Port

**Note:** All products tested using Krytox™ Grease. Please contact factory for individual test results and additional clean room requirements.

# MODULAR MOUNTING SOLUTIONS

## Grippers/Slides/Rotaries | Product Overview

Destaco's modular automation systems feature DIRECTCONNECT™ technology, allowing all components of the system—base slides, block thrusters, thruster slides, grippers, and mounting stanchions—to be mounted together quickly and easily without any adapter plates.

- Reduces engineering design
- Saves \$\$\$ with modular solutions
- Change device orientations quickly
- Eliminates Adapter Plates

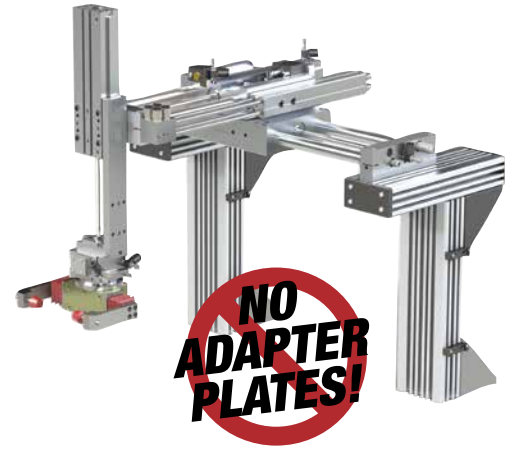

### Modular DIRECTCONNECT Mounting Style Examples:

Look for more examples of each main section of the catalog. This is a sample of configurations we offer. Custom solutions also available.

#### Grip & Rotate

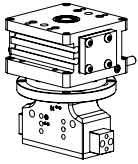

**DRF Rotary Actuator to DPDL Parallel Gripper**

#### Pick & Rotate

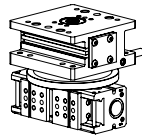

**DRF Rotary Actuator to DPP Parallel Gripper**

#### Place & Rotate

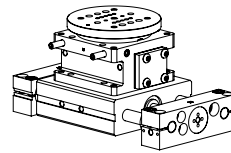

**DLB Base Slide to DRF Rotary Actuator**

#### Place & Rotate

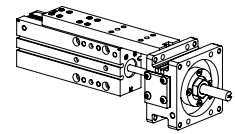

**DLM Linear Slide to DRG Rotary Actuator**

#### Rotate & Place

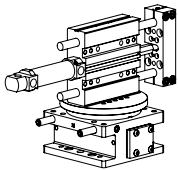

**DRF Rotary Actuator to DLT Linear Slide**

#### Pick & Place

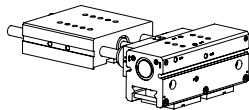

**DLT Base Slide to DPP Parallel Gripper**

#### Place & Place

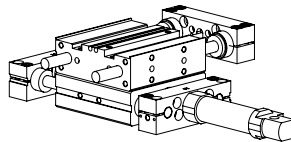

**DLB Base Slide to DLT Linear Slide**

#### Place & Place

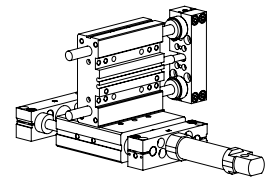

**DLB Base Slide to DLT Linear Slide**

### Connect Different Sizes & Styles

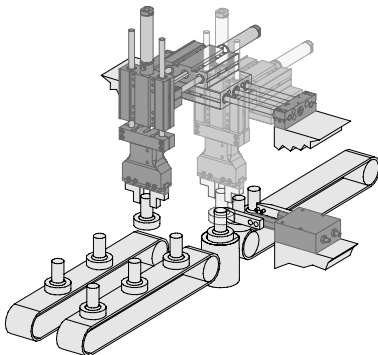

### Configure in Multiple Orientations

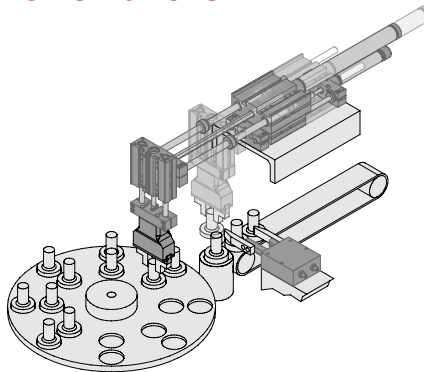

### Look for the DIRECTCONNECT Logo

Product Series beginning with the letter D have a DIRECTCONNECT option, with a few exceptions.

**DIRECTCONNECT™**

# HOW TO MAKE A DIRECTCONNECT™ MOUNT

## Grippers/Slides/Rotaries | Product Overview

The DIRECTCONNECT Modular Compatibility Chart (on the next page) shows all the products that can easily connect together without adapter plates. Simply locate your first product along the horizontal axis of the top of chart, then locate the second product along the vertical axis on the left side of the chart. If a connection can be made, a mounting pattern will be shown.

### DIRECTCONNECT Modular Compatibility Example:

Shown below, a DLB-10,12,16 Base Slide connecting to a DLT-10,12,16 Linear Thruster. Units may connect on different faces of the unit. Please refer to individual datasheets for DIRECTCONNECT mounting surfaces.

Catalog Models		Base Slides			Thruster Slides				
		DLB-06,08	DLB-10,12,16	DLB-20,25	DLT-06,08	DLT-10,12,16	DLT-20,25	DLM-07	DLM-09,12
Base Slides	DLB-06,08				3R,3S			3R,3S	
	DLB-10,12,16				3S	5R,5S		3S	5R,5S
	DLB-20,25					5S	10R,10S		5S
Thruster Slides	DLT-06,08	3R,3S	3S		3R	3R		3R	3R
	DLT-10,12,16		5R,5S	5S		5R	5R		5R
	DLT-20,25			10R,10S			10R		
	DLM-07	3R,3S	3S		3R	3R		3R	3R
	DLM-9,12		5S			5R	5R		5R
	DRF-075,094					5R	5R		5R

**Note:** The numbers in the cell represent the metric screw size and basic mounting pattern. S=Square, R=Rectangle. ie; 5S = M5 Screw with square mounting pattern.

### DirectConnect Mounting Surface Example:

Locate matching DIRECTCONNECT mounting pattern icons on the products dimensional drawings to determine what surface faces can be connected to. Corresponding mates equal a DIRECTCONNECT connection.

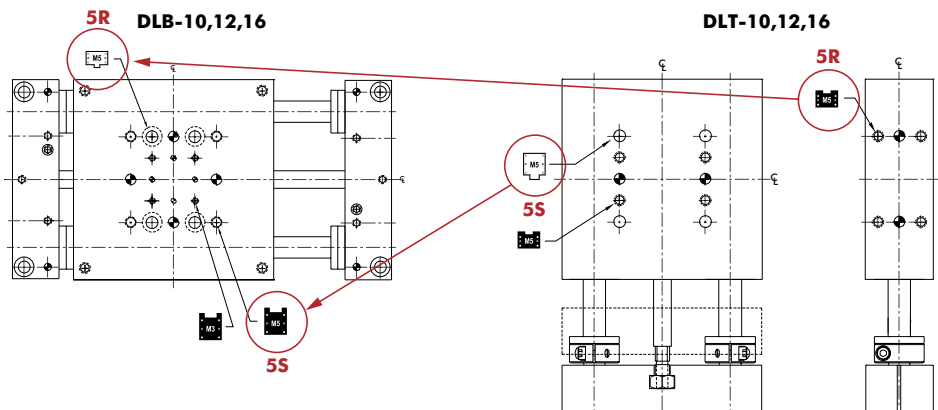

# DIRECTCONNECT™ MODULAR COMPATIBILITY CHART

## Grippers/Slides/Rotaries | Product Overview

Destaco's modular automation systems feature DirectConnect™ technology, allowing all components of the system—base slides, block thrusters, thruster slides, grippers, and rotaries—to be mounted together quickly & easily without any adapter plates. Look for matching icons on product datasheets for mounting compatibility.

Simply locate your first product along the horizontal axis of the top of chart, then locate the second product along the vertical axis on the left side of the chart. If a connection can be made, a mounting pattern will be shown.

**Note:** The numbers in the cell represent the metric screw size and basic mounting pattern. S=Square, R=Rectangle. ie; 5S = M5 Screw with square mounting pattern.

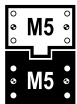
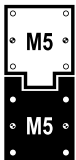

M5 (S)quare    M5 (R)ectangle

Catalog Models		Base Slides		
		DLB-06&08	DLB-10,12&16	DLB-20&25
Base Slides	DLB-06 & 08			
	DLB-10, 12 & 16			
	DLB-20 & 25			
Thruster Slides	DLT-06 & 08	3R,3S	3S	
	DLT-10, 12 & 16		5R,5S	5S
	DLT-20 & 25			10R,10S
	DLM-07	3R,3S	3S	
	DLM-9 & 12		5R,5S	5S
Rotary Actuators	DRF-075 & 094		5R	
	DRF-106		5R	10R
	DRF-131		5R	10R
	DRG-074 & 094		5R	
	DRG-106		5R	10R
	DRG-131		5R	10R
Grippers	DGC		5R	
	DPG		5R	
	DCT-12, 16 & 25	3R		
	DCT-25		5R	
	DPDL-047 & 056	3R		
	DPDL-088 & 125		5R	
	DPDL-175 & 250			10R
	DPDS-047 & 056	3R		
	DPDS-088 & 125		5R	
	DPDS-175 & 250			10R
	DPL-25xx		5R	
	DPL-32xx & 40xx			10R
	DPP-10 & 14	3R		
	DPP-20		5R	
	DPP-28		5R	10R
	DPW-250	3R		
	DPW-375 & 500		5R	
	G110-08 & 011	3R		
	G110-18 & 25		5R	
	DPE-200		5R	
DPE-400			10R	



# DIRECTCONNECT™ MODULAR COMPATIBILITY CHART

## Grippers/Slides/Rotaries | Product Overview

Thruster Slides					Rotary Actuators		
DLT-06&08	DLT-10,12&16	DLT-20&25	DLM-07	DLM-09&12	DRF-075&094	DRF-106	DRF-131
3R,3S			3R,3S				
3S	5R,5S		3S	5R,5S	5R	5R	5R
	5S	10R,10S		5S		10R	10R
3R	3R		3R	3R	3R,3S	3R,3S	
	5R	5R		5R	5R,5S	5R,5S	5R,5S
		10R					10R,10S
3R	3R		3R	3R	3R,3S	3R,3S	
	5R	5R		5R	5R,5S	5R,5S	5R,5S
	5R	5R		5R	5R	5R	5R
	5R	10R		5R	5R	5R	10R
	5R	10R		5R	5R	5R	10R
	5R	5R		5R	5R	5R	5R
	5R	10R		5R	5R	5R	10R
	5R	10R		5R	5R	5R	10R
	5R	5R		5R	5R	5R	5R
	5R	5R		5R	5R	5R	5R
3R	3R		3R	3R	3R	3R	
	5R	5R		5R	5R	5R	5R
3R	3R		3R	3R	3R	3R	
	5R	5R		5R	5R	5R	5R
		10R					10R
3R	3R		3R	3R	3R	3R	
	5R	5R		5R	5R	5R	5R
		10R					10R
	5R	5R		5R	5R	5R	5R
		10R					10R
3R	3R		3R	3R	3R	3R	
	5R	5R		5R	5R	5R	5R
	5R	10R		5R	5R	5R	10R
3R	3R		3R	3R	3R	3R	
	5R	5R		5R	5R	5R	5R
3R	3R		3R	3R	3R	3R	
	5R	5R		5R	5R	5R	5R
	5R	5R		5R	5R	5R	5R
		10R					10R

# NORTH AMERICAN XPRESS PROGRAM







A Full Line of Automation Products to Meet Your Application Needs Quickly



STANDARD LEAD TIME

Product listed below are for North American Market only.

## Parallel Grippers

		SIZE	STROKE [mm]	FORCE [N]
	<b>RP Series</b> Rugged Impact Resistant Gripper	5, 10, 11, 12, 15	4.0-12.7	156-311
	<b>RPL/RPLC Series</b> Zero Side Play, High Repeatability Gripper	1, 2, 3, 4 (C)=Clean Room Version	6.4-25.4	116-160
	<b>RPM/RPMC Series</b> Low Friction Micro Gripper	1, 2, 3, (C)=Clean Room Version	4.1-6.3	36
	<b>DPG Series</b> Modular Multi-Part Sensing Gripper	10M-2	12.7	222
	<b>HEAVY DUTY</b> <b>DPW Series</b> Wide Parts/ Long Finger Gripper	250, 375, 500	19.05-63.5	222-800
	<b>HEAVY DUTY</b> <b>RPW Series</b> Wide Parts/ Long Finger Gripper	625	50.8-88.9	1068

## Angular Grippers

		SIZE	ANGLE	FORCE [N]
	<b>RA Series</b> Low Cost Small Size Angular Gripper	RA-5	15° (per finger)	89

## Rotary Actuators

		SIZE	ANGLE	PAYLOAD [Kg]
	<b>RR Series</b> High Torque Compact Rotary Actuators	18, 28, 36	0-180°	0.45-3.6

To choose the best and most cost-effective automation solution for your application please contact your Destaco sales representative or Destaco customer service.

# EUROPEAN XPRESS PROGRAM

A Full Line of Automation Products to Meet Your Application Needs Quickly



STANDARD LEAD TIME

Product listed below are for European Market only.



SIZE











STROKE [mm]



FORCE [N]

## Parallel Grippers

	<b>RTH Series</b> 3 Jaw Centering Gripper	1, 2, 3, 4, 5, 6	4-70	445-44353
	<b>RP Series</b> Rugged Impact Resistant Gripper	5, 10, 11, 12, 15	4.0-12.7	156-311
	<b>RPL/RPLC Series</b> Zero Side Play, High Repeatability Gripper	RPL: 1, 2, 3, 4 RPLC: 1, 3 (C)=Clean Room	6.4-25.4	116-160
	<b>RPM Series</b> Low Friction Micro Gripper	1, 3	4.1-6.3	36
	<b>DGC Series</b> Precision Spring Gripper	25, 45, 65	20-40	432-11475
	<b>RDH Series</b> Shielded Gripper	1, 2, 3, 4, 5, 6 with Options -C, -L	4-70	361-28002
	<b>HEAVY DUTY</b> <b>DPW Series</b> Wide Parts/ Long Finger Gripper	250, 375, 500	19.05-63.5	222-800
	<b>HEAVY DUTY</b> <b>RPW Series</b> Wide Parts/ Long Finger Gripper	625, 750	19.1-114.3	222-2091

To choose the best and most cost-effective automation solution for your application please contact your Destaco sales representative or Destaco customer service.

# EUROPEAN XPRESS PROGRAM

A Full Line of Automation Products to Meet Your Application Needs Quickly



STANDARD LEAD TIME

Product listed below are for European Market only.



## Rotary Actuators

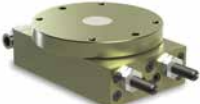

		SIZE	ANGLE	PAYLOAD [Kg]
	<b>RR Series</b> High Torque Compact Rotary Actuators	18, 28	0-180°	0.45-1.3
	<b>HEAVY DUTY</b> <b>RR Series</b> High Torque Compact Rotary Actuators	36, 45, 56, 66	0-180°	3.6-91

## Tool Changers

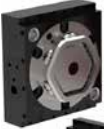

		SIZE	PORTS	PAYLOAD [Kg]
	<b>HEAVY DUTY</b> <b>RQC Series</b> Robot Side	200, 400, 800, 1200 Options E19, G19	19 pin Electrical and 6 Pneumatic Ports	90-550
	<b>HEAVY DUTY</b> <b>RTP Series</b> Tool Side			
	<b>QC Series</b> Robot Side	30, 60, 150 Options E12, E15	12-15 pin Electrical and 4 Pneumatic Ports	30-150
	<b>TP Series</b> Tool Side			

To choose the best and most cost-effective automation solution for your application please contact your Destaco sales representative or Destaco customer service.

# PARALLEL GRIPPERS

## Sizing and Application Chart

CLICK OR SCAN

To view full  
catalog pages  
on this product



	Series	Page #	Jaws		Basic Unit Dimensions mm [in]			Stroke mm [in]														
			2 Jaws	3 Jaws	Length	Width	Height	0-6.3 [0-0.25]	6.3-12.7 [0.25-0.50]	12.7-19.1 [0.50-0.75]	19.1-25.4 [0.75-1.00]	25.4-31.8 [1.00-1.25]	31.8-38.1 [1.25-1.50]	38.1-44.5 [1.50-1.75]	44.5-50.8 [1.75-2.00]	50.8-57.1 [2.00-2.25]	57.1-63.5 [2.25-2.50]	63.5-69.8 [2.50-2.75]	69.8-76.2 [2.75-3.00]	76.2+ [3.00+]		
<b>OEM Grippers</b>																						
	G110-08M	34	●		[1.69-4.06] 43-103	20 [0.79]	28 [1.10]	●	●													
	G110-11M	34	●		[1.69-4.06] 43-103	24 [0.94]	36.5 [1.44]	●	●													
	G110-18M	34	●		[2.13-4.92] 54-125	30 [1.18]	43 [1.69]	●	●	●												
	G110-25M	34	●		[2.87-7.60] 73-193	40 [1.57]	61 [2.40]	●	●	●	●											
<b>Electric Grippers</b>																						
	DPE-200	41	●		67.9 [2.67]	28 [1.10]	128 [5.04]	●	●													
	DPE-400	40	●		159.6 [6.28]	60 [2.36]	129.5 [5.10]	●	●													
	RPE-100	41	●		32 [1.26]	40 [1.57]	94 [3.70]	●														
<b>Precision Grippers</b>																						
	6002P	42	●		72 [2.83]	60 [2.36]	77 [3.03]	●	●													
	6002P-C	42	●		78 [3.07]	60 [2.36]	77 [3.03]	●	●													
	8002P	42	●		91.6 [3.61]	80 [3.15]	78 [3.07]	●	●													
	8002P-C	42	●		98.4 [3.87]	80 [3.15]	78 [3.07]	●	●	●												
	11002P	42	●		126 [4.96]	110 [4.33]	106 [4.17]	●	●													
	11002P-C	42	●		136 [5.35]	110 [4.33]	106 [4.17]	●	●	●												
	1400P	42	●		165 [6.50]	140 [5.51]	137 [5.39]	●	●	●	●											
	14002P-C	42	●		179 [7.05]	140 [5.51]	137 [5.39]	●	●	●	●	●										
	16002P	42	●		194 [7.64]	165 [6.50]	169 [6.65]	●	●	●	●											
	16002P-C	42	●		204 [8.03]	165 [6.50]	169 [6.65]	●	●	●	●	●										
16502PGR	42	●		210 [8.27]	165 [6.50]	262 [10.31]	●	●	●	●												
	DGC-25	44	●		75 [2.95]	38 [1.50]	55 [2.17]	●	●	●												
	DGC-45	44	●		95 [3.74]	42 [1.65]	70 [2.76]	●	●	●												
	DGC-65	44	●		125 [4.92]	53 [2.09]	90 [3.54]	●	●	●	●											
	GC-85	44	●		155 [6.10]	67.5 [2.66]	120 [4.72]	●	●	●	●	●										
	GC-105	44	●		190 [7.48]	85.5 [3.37]	145 [5.71]	●	●	●	●	●	●									
	DPL-2520	46	●		152 [5.98]	75 [2.95]	65 [2.56]	●	●	●	●											
	DPL-2535	46	●		197 [7.76]	75 [2.95]	65 [2.56]	●	●	●	●	●										
	DPL-3230	46	●		186 [7.32]	93 [3.66]	74 [2.91]	●	●	●	●	●										
	DPL-3250	46	●		246 [9.69]	93 [3.66]	74 [2.91]	●	●	●	●	●	●									
	DPL-4040	46	●		238 [9.37]	112 [4.41]	91 [3.58]	●	●	●	●	●	●	●								
	DPL-4070	46	●		328 [12.91]	112 [4.41]	91 [3.58]	●	●	●	●	●	●	●	●							
	DPP-10M-06	48	●		62.9 [2.48]	25 [0.98]	34.67 [1.36]	●														
	DPP-10M-12	48	●		73.7 [2.90]	25 [0.98]	34.67 [1.36]	●	●													
	DPP-14M-15	48	●		90.2 [3.55]	34 [1.34]	42.21 [1.66]	●	●													
	DPP-14M-25	48	●		118.7 [4.67]	34 [1.34]	42.21 [1.66]	●	●	●												
	DPP-20M-25	48	●		129 [5.08]	46 [1.81]	55.63 [2.19]	●	●	●												
	DPP-20M-38	48	●		175.5 [6.91]	46 [1.81]	55.63 [2.19]	●	●	●	●											
	DPP-28M-31	48	●		162.3 [6.39]	58 [2.28]	72.54 [2.86]	●	●	●	●	●										
	DPP-28M-50	48	●		221.5 [8.72]	58 [2.28]	72.54 [2.86]	●	●	●	●	●	●									



# PARALLEL GRIPPERS

## Sizing and Application Chart

CLICK OR SCAN

To view full catalog pages on this product



	Series	Page #	Jaws		Basic Unit Dimensions mm [in]			Stroke mm [in]														
			2 Jaws	3 Jaws	Length	Width	Height	0-6.3 [0-0.25]	6.3-12.7 [0.25-0.50]	12.7-19.1 [0.50-0.75]	19.1-25.4 [0.75-1.00]	25.4-31.8 [1.00-1.25]	31.8-38.1 [1.25-1.50]	38.1-44.5 [1.50-1.75]	44.5-50.8 [1.75-2.00]	50.8-57.1 [2.00-2.25]	57.1-63.5 [2.25-2.50]	63.5-69.8 [2.50-2.75]	69.8-76.2 [2.75-3.00]	76.2+ [3.00+]		
<b>Precision Grippers (cont.)</b>																						
	RP-50P	50	●		57 [2.24]	25.4 [1.00]	46.7 [1.84]	●														
	RP-100P	50	●		83 [3.27]	25.4 [1.00]	59.4 [2.34]	●														
	RP-25P	50	●		108 [4.25]	31.8 [1.25]	81.1 [3.19]	●														
	RP-35P	50	●		143 [5.63]	50.8 [2.00]	103.2 [4.06]	●														
	RP-40P	50	●		178 [7.01]	[2.25] 57.2	125 [4.92]	●														
	RP-43P	50	●		292 [11.50]	74.7 [2.94]	175 [6.89]	●														
	RPL/RPLC-1	52	●		44.5 [1.75]	19.1 [0.75]	29.5 [1.16]	●														
	RPL/RPLC-2	52	●		59.5 [2.34]	19.1 [0.75]	29.5 [1.16]	●														
	RPL/RPLC-3	52	●		80 [3.15]	22.2 [0.87]	32.6 [1.28]	●														
	RPL/RPLC-4	52	●		98.1 [3.86]	22.2 [0.87]	32.6 [1.28]	●														
<b>General Industrial Grippers</b>																						
	CP-1	54	●		37.6 [1.48]	30 [1.18]	39.2 [1.54]	●														
	CP-1-C	54	●		42 [1.65]	30 [1.18]	39.2 [1.54]	●														
	CP-2	54	●		51.4 [2.02]	40 [1.57]	51.5 [2.03]	●														
	CP-2-C	54	●		58.2 [2.29]	40 [1.57]	51.5 [2.03]	●														
	CP-3	54	●		70 [2.76]	55 [2.17]	67 [2.64]	●														
	CP-3-C	54	●		81.2 [3.20]	55 [2.17]	67 [2.64]	●														
	CP-4	54	●		85 [3.35]	65 [2.56]	74 [2.91]	●														
	CP-4-C	54	●		96 [3.78]	65 [2.56]	74 [2.91]	●														
	CP-5	54	●		102 [4.02]	80 [3.15]	91 [3.58]	●														
	CP-5-C	54	●		120 [4.72]	80 [3.15]	91 [3.58]	●														
	CP-6	54	●		125 [4.92]	100 [3.94]	114 [4.49]	●														
CP-6-C	54	●		141 [5.55]	100 [3.94]	114 [4.49]	●															
	DPDL-047	56	●		54.5 [2.16]	22.2 [0.875]	32.2 [1.27]	●														
	DPDL-056	56	●		68.7 [2.70]	24.1 [0.950]	37.7 [1.48]	●														
	DPDL-088	56	●		101.1 [3.98]	36.1 [1.420]	56 [2.20]	●														
	DPDL-125	56	●		128.4 [5.06]	43.2 [1.700]	68.5 [2.70]	●														
	DPDL-175	56	●		183.1 [7.21]	64.8 [2.550]	100.2 [3.94]	●														
	DPDL-250	56	●		243.8 [9.60]	79.3 [3.125]	123.3 [4.85]	●														
	DPDS-047	58	●		31.2 [1.23]	22.2 [0.87]	25.9 [1.02]	●														
	DPDS-056	58	●		39.8 [1.57]	24.1 [0.95]	28.9 [1.14]	●														
	DPDS-088	58	●		57.4 [2.26]	36.1 [1.42]	43.4 [1.71]	●														
	DPDS-125	58	●		73.5 [2.89]	43.2 [1.70]	52.7 [2.07]	●														
	DPDS-175	58	●		114.7 [4.52]	64.8 [2.55]	80.4 [3.17]	●														
	DPDS-250	58	●		133.1 [5.24]	79.3 [3.12]	95.5 [3.76]	●														
	DPG-10M-1	60	●		62 [2.44]	34.9 [1.37]	44.9 [1.77]	●														
	DPG-10M-2	60	●		86 [3.39]	34.9 [1.37]	44.9 [1.77]	●														
	DPG-10M-3	60	●		113 [4.45]	34.9 [1.37]	44.9 [1.77]	●														
	DPG-10M-4	60	●		137 [5.39]	34.9 [1.37]	44.9 [1.77]	●														



CLICK OR SCAN

To view full catalog pages on this product

# PARALLEL GRIPPERS

## Sizing and Application Chart

Total Gripforce N [lbs]	Maximum Finger Length @ 60psi mm [in]	Actuation Time	Operating Pressure bar [psi]	Environ- ment	Features
0.45-45 [1-10] 45-111 [10-25] 111-223 [25-50] 223-445 [50-100] 445-2225 [100-500] 2225-13350 [500-3000]	0-50.8 [0-2] 50.8-102 [2-4] 102-152 [4-6] 152-203 [6-8] 203-254 [8-10] 254-305 [10-12] 305-356 [12-14] 356-406 [14-16] 406-457 [16-18] 457-508 [18-20] 508+ [20 +]	0.05-0.1 sec. 0.1-0.5 sec. 0.5-0.75 sec. 0.75-1 sec.	5-100 [0.3-7] 20-100 [1.5-7] 29-145 [2-10] 36-145 [2.5-10] 40-100 [3-7] 50-100 [3.5-7] 70-150 [5-7]	Clean Room Environment Normal Environment Harsh/Dirty Environment	Fail-safe Operation Inductive Sensors Magneto Resistive Sensors Double Acting Cylinder Single Acting/Spring Return Double Acting/Spring Assist Non-Synchronous Option
Precision Grippers (cont.)					
General Industrial Grippers					





# PARALLEL GRIPPERS

## Sizing and Application Chart

CLICK OR SCAN

To view full  
catalog pages  
on this product

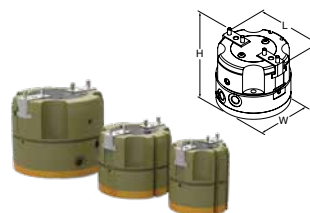

	Series	Page #	Jaws		Basic Unit Dimensions mm [in]			Stroke mm [in]														
			2 Jaws	3 Jaws	Length	Width	Height	0-6.3 [0-0.25]	6.3-12.7 [0.25-0.50]	12.7-19.1 [0.50-0.75]	19.1-25.4 [0.75-1.00]	25.4-31.8 [1.00-1.25]	31.8-38.1 [1.25-1.50]	38.1-44.5 [1.50-1.75]	44.5-50.8 [1.75-2.00]	50.8-57.1 [2.00-2.25]	57.1-63.5 [2.25-2.50]	63.5-69.8 [2.50-2.75]	69.8-76.2 [2.75-3.00]	76.2+ [3.00+]		
<b>General Industrial Grippers (cont.)</b>																						
	RDH-1	62	●		63 [2.48]	33 [1.30]	38.5 [1.52]	●														
	RDH-1-L	62	●		63 [2.48]	33 [1.30]	38.5 [1.52]	●●														
	RDH-2	62	●		83 [3.27]	40 [1.57]	58 [2.28]	●														
	RDH-2-L	62	●		83 [3.27]	40 [1.57]	58 [2.28]	●●														
	RDH-3	62	●		104 [4.09]	50 [1.97]	66 [2.60]	●●														
	RDH-3-L	62	●		104 [4.09]	50 [1.97]	66 [2.60]	●●●														
	RDH-4	62	●		129 [5.08]	60 [2.36]	74.5 [2.93]	●●														
	RDH-4-L	62	●		129 [5.08]	60 [2.36]	74.5 [2.93]	●●●														
	RDH-5	62	●		162 [6.38]	76 [2.99]	90.5 [3.56]	●●●														
	RDH-5-L	62	●		162 [6.38]	76 [2.99]	90.5 [3.56]	●●●●														
	RDH-6	62	●		205 [8.07]	100 [3.94]	113 [4.45]	●●●														
	RDH-6-L	62	●		205 [8.07]	100 [3.94]	113 [4.45]	●●●●														
	RDH-7	62	●		258 [10.16]	120 [4.72]	147 [5.79]	●●●●														
	RDH-7-L	62	●		258 [10.16]	120 [4.72]	147 [5.79]	●●●●●														
RDH-8	62	●		355 [13.98]	180 [7.09]	201 [7.91]	●●●●●															
RDH-8-L	62	●		355 [13.98]	180 [7.09]	201 [7.91]	●●●●●●															
	REP-62	64	●		70 [2.76]	60 [2.36]	72 [2.83]	●●														
	REP-62-C	64	●		82 [3.23]	60 [2.36]	72 [2.83]	●●●														
	REP-82	64	●		94 [3.70]	80 [3.15]	74 [2.91]	●●														
	REP-82-C	64	●		108 [4.25]	80 [3.15]	74 [2.91]	●●●														
	REP-112	64	●		138 [5.43]	110 [4.33]	98 [3.86]	●●														
	REP-112-C	64	●		158 [6.22]	110 [4.33]	98 [3.86]	●●●														
	RP-5	66	●		29 [1.14]	25.4 [1.00]	36.5 [1.44]	●														
	RP-10	66	●		38.1 [1.50]	31.7 [1.25]	37.3 [1.47]	●														
	RP-11	68	●		48 [1.89]	31.8 [1.25]	28.6 [1.13]	●														
	RP-11-D	68	●		45 [1.77]	31.8 [1.25]	28.6 [1.13]	●														
	RP-12	68	●		63 [2.48]	31.8 [1.25]	35.6 [1.40]	●●														
	RP-12-D	68	●		60 [2.36]	31.8 [1.25]	35.6 [1.40]	●														
	RP-15	68	●		81 [3.19]	41.3 [1.63]	47.3 [1.86]	●●														
	RP-15-D	68	●		76 [2.99]	41.3 [1.63]	47.3 [1.86]	●●														
	RP-17	68	●		108 [4.25]	54 [2.13]	61.9 [2.44]	●●●														
	RP-17-D	68	●		117 [4.61]	54 [2.13]	61.9 [2.44]	●●●●														
	RP-18	68	●		177 [6.97]	74.9 [2.95]	92.8 [3.65]	●●●●														
	RP-18-D	68	●		190 [7.48]	74.9 [2.95]	92.8 [3.65]	●●●●●														
	RP-19	68	●		266 [10.47]	100.3 [3.95]	118.7 [4.67]	●●●●●														
RP-19-D	68	●		254 [10.00]	100.3 [3.95]	118.7 [4.67]	●●●●●															



**CLICK OR SCAN**

To view full catalog pages on this product

# PARALLEL GRIPPERS

## Sizing and Application Chart

Total Gripforce N [lbs]		Maximum Finger Length @ 60psi mm [in]		Actuation Time		Operating Pressure bar [psi]		Environ- ment		Features																													
0.45-45 [1-10]	45-111 [10-25]	111-223 [25-50]	223-445 [50-100]	445-2225 [100-500]	2225-13350 [500-3000]	0-50.8 [0-2]	50.8-102 [2-4]	102-152 [4-6]	152-203 [6-8]	203-254 [8-10]	254-305 [10-12]	305-356 [12-14]	356-406 [14-16]	406-457 [16-18]	457-508 [18-20]	508+ [20+]	0.05-0.1 sec.	0.1-0.5 sec.	0.5-0.75 sec.	0.75-1 sec.	5-100 [0.3-7]	20-100 [1.5-7]	30-100 [2-7]	40-100 [3-7]	45-100 [3.1-7]	50-100 [3.5-7]	60-100 [4-7]	70-150 [5-7]	Clean Room Environment	Normal Environment	Harsh/Dirty Environment	Failsafe Operation	Inductive Sensors	Magneto Resistive Sensors	Double Acting Cylinder	Single Acting/Spring Return	Double Acting/Spring Assist	Non-Synchronous Option	
												General Industrial Grippers (cont.)																											

Dimensions and technical information are subject to change without notice

# PARALLEL GRIPPERS

## Sizing and Application Chart

CLICK OR SCAN

To view full  
catalog pages  
on this product



	Series	Page #	Jaws			Basic Unit Dimensions mm [in]			Stroke mm [in]												
			2 Jaws	3 Jaws	Length	Width	Height	0-6.3 [0-0.25]	6.3-12.7 [0.25-0.50]	12.7-19.1 [0.50-0.75]	19.1-25.4 [0.75-1.00]	25.4-31.8 [1.00-1.25]	31.8-38.1 [1.25-1.50]	38.1-44.5 [1.50-1.75]	44.5-50.8 [1.75-2.00]	50.8-57.1 [2.00-2.25]	57.1-63.5 [2.25-2.50]	63.5-69.8 [2.50-2.75]	69.8-76.2 [2.75-3.00]	76.2+ [3.00+]	
<b>General Industrial Grippers (cont.)</b>																					
	RPM/RPMC-1	70	●		23 [0.91]	16 [0.63]	24 [0.94]	●													
	RPM/RPMC-2	70	●		24 [0.94]	16 [0.63]	25.5 [1.00]	●													
	RPM/RPMC-3	70	●		30 [1.18]	16 [0.63]	25.5 [1.00]	●													
	RPS-11	72	●		48 [1.88]	31.8 [1.25]	44.1 [1.74]	●													
	RPS-11-D	72	●		45 [1.79]	31.8 [1.25]	44.1 [1.74]	●													
	RPS-12	72	●		63 [2.50]	31.8 [1.25]	51.2 [2.02]	●●													
	RPS-12-D	72	●		60 [2.37]	31.8 [1.25]	51.2 [2.02]	●													
	RPS-15	72	●		81 [3.19]	41.3 [1.63]	71.6 [2.82]	●●													
	RPS-15-D	72	●		76 [3.00]	41.3 [1.63]	71.6 [2.82]	●●													
	RPS-17	72	●		107 [4.25]	54.0 [2.13]	98.7 [3.89]	●●●													
	RPS-17-D	72	●		117 [4.60]	54.0 [2.13]	98.7 [3.89]	●●●●													
	RPS-18	72	●		177 [7.00]	74.9 [2.95]	154.4 [6.08]	●●●●●													
	RPS-18-D	72	●		190 [7.45]	74.9 [2.95]	154.4 [6.08]	●●●●●●													
<b>Heavy-Duty Grippers</b>																					
	DPW-250-1	74	●		98 [3.86]	37.6 [1.48]	37.6 [1.48]	●●													
	DPW-250-2	74	●		136 [5.35]	37.6 [1.48]	37.6 [1.48]	●●●													
	DPW-375-1	74	●		122 [4.80]	54 [2.13]	54 [2.13]	●●●													
	DPW-375-2	74	●		198 [7.80]	54 [2.13]	54 [2.13]	●●●●													
	DPW-500-1	74	●		164 [6.46]	63 [2.48]	63 [2.48]	●●●●													
	DPW-500-2	74	●		240 [9.45]	63 [2.48]	63 [2.48]	●●●●●													
	RPB-24	76	●		438.2 [17.25]	88.9 [3.50]	129 [5.08]	●●●●●●													
	RPB-26	76	●		590.5 [23.25]	88.9 [3.50]	129 [5.08]	●●●●●●●													
	RPB-28	76	●		734 [28.90]	88.9 [3.50]	129 [5.08]	●●●●●●●●													
	RPR-63-150	78	●		489.8 [19.28]	88.9 [3.50]	161.9 [6.37]	●●●●●●●													
	RPR-63-200	78	●		539.8 [21.25]	88.9 [3.50]	161.9 [6.37]	●●●●●●●●													
	RPR-63-250	78	●		589.8 [23.22]	88.9 [3.50]	161.9 [6.37]	●●●●●●●●●													
	RPR-63-300	78	●		639.8 [25.19]	88.9 [3.50]	161.9 [6.37]	●●●●●●●●●●													
	RPR-63-350	78	●		689.8 [27.16]	88.9 [3.50]	161.9 [6.37]	●●●●●●●●●●●													
	RPW-250	80	●		93 [3.66]	31.5 [1.24]	40.9 [1.61]	●●													
	RPW-375-1	80	●		120 [4.72]	37.8 [1.49]	50.5 [1.99]	●●●													
	RPW-375-2	80	●		187 [7.36]	37.8 [1.49]	50.5 [1.99]	●●●●													
	RPW-500-1	80	●		171 [6.73]	56.9 [2.24]	66.4 [2.61]	●●●●													
	RPW-500-2	80	●		234 [9.21]	56.9 [2.24]	66.4 [2.61]	●●●●●													
	RPW-625-1	80	●		219 [8.62]	66.4 [2.61]	82.3 [3.24]	●●●●													
	RPW-625-2	80	●		321 [12.64]	66.4 [2.61]	82.3 [3.24]	●●●●●													
	RPW-750	80	●		410 [16.14]	75 [2.95]	99.8 [3.93]	●●●●●●													



# PARALLEL GRIPPERS

## Sizing and Application Chart

CLICK OR SCAN

To view full  
catalog pages  
on this product



	Series	Page #	Jaws		Basic Unit Dimensions mm [in]		Stroke mm [in]													
			2 Jaws	3 Jaws	Diameter	Height	0-6.3 [0-0.25]	6.3-12.7 [0.25-0.50]	12.7-19.1 [0.50-0.75]	19.1-25.4 [0.75-1.00]	25.4-31.8 [1.00-1.25]	31.8-38.1 [1.25-1.50]	38.1-44.5 [1.50-1.75]	44.5-50.8 [1.75-2.00]	50.8-57.1 [2.00-2.25]	57.1-63.5 [2.25-2.50]	63.5-69.8 [2.50-2.75]	69.8-76.2 [2.75-3.00]	76.2+ [3.00+]	
	6003P	82	●		72 [2.83]	77 [3.03]	●	●												
	6003P-C	82	●		78 [3.07]	77 [3.03]	●	●	●											
	8003P	82	●		91.6 [3.61]	78 [3.07]	●	●	●											
	8003P-C	82	●		98.4 [3.87]	78 [3.07]	●	●	●	●										
	11003P	82	●		126 [4.96]	106 [4.17]	●	●	●	●										
	11003P-C	82	●		136 [5.35]	106 [4.17]	●	●	●	●	●									
	14003P	82	●		165 [6.50]	137 [5.39]	●	●	●	●	●									
	14003P-C	82	●		179 [7.05]	137 [5.39]	●	●	●	●	●	●								
	16503P	82	●		194 [7.64]	169 [6.65]	●	●	●	●	●	●								
	16503P-C	82	●		204 [8.03]	169 [6.65]	●	●	●	●	●	●	●							
	RTH-1M	84	●		63 [2.48]	43 [1.69]	●													
	RTH-1M-L	84	●		63 [2.48]	43 [1.69]	●	●												
	RTH-2M	84	●		83 [3.27]	57 [2.24]	●													
	RTH-2M-L	84	●		83 [3.27]	57 [2.24]	●	●												
	RTH-3M	84	●		83 [3.27]	57 [2.24]	●	●												
	RTH-3M-L	84	●		83 [3.27]	57 [2.24]	●	●	●											
	RTH-4M	84	●		129 [5.08]	88.5 [3.48]	●	●												
	RTH-4M-L	84	●		129 [5.08]	88.5 [3.48]	●	●	●											
	RTH-5M	84	●		162 [6.38]	98.5 [3.88]	●	●	●											
	RTH-5M-L	84	●		162 [6.38]	98.5 [3.88]	●	●	●	●										
	RTH-6M	84	●		205 [8.07]	121 [4.76]	●	●	●											
	RTH-6M-L	84	●		205 [8.07]	121 [4.76]	●	●	●	●										
	RTH-7M	84	●		258 [10.16]	155 [6.10]	●	●	●	●										
	RTH-7M-L	84	●		258 [10.16]	155 [6.10]	●	●	●	●	●									
RTH-8M	84	●		355 [13.98]	209 [8.23]	●	●	●	●	●										
RTH-8M-L	84	●		355 [13.98]	209 [8.23]	●	●	●	●	●	●									
	PPC-12	86	●		43 [1.69]	74 [2.91]	●	●												
	PPC-12-C	86	●		49.03 [1.93]	78 [3.07]	●	●	●											
	PPC-25	86	●		61.5 [2.42]	87 [3.43]	●	●												
	PPC-25-C	86	●		68.5 [2.70]	92 [3.62]	●	●	●											
	PPC-34	86	●		82.5 [3.25]	112 [4.41]	●	●	●	●										
	PPC-34-C	86	●		92.5 [3.64]	117 [4.61]	●	●	●	●										
	REP-63	88	●		72 [2.83]	77 [3.03]	●	●												
	REP-63-C	88	●		78 [3.07]	77 [3.03]	●	●	●											
	REP-83	88	●		91.6 [3.61]	78 [3.07]	●	●												
	REP-83-C	88	●		98.4 [3.87]	78 [3.07]	●	●	●	●										
	REP-113	88	●		126 [4.96]	103 [4.06]	●	●	●	●										
	REP-113-C	88	●		136 [5.35]	103 [4.06]	●	●	●	●	●									
	RPC-315	90	●		62 [2.44]	41 [1.61]	●	●												
	RPC-320	90	●		82 [3.23]	50 [1.97]	●	●												
	RPC-331	90	●		118 [4.65]	75.1 [2.96]	●	●	●											
	RPC-344	90	●		140 [5.51]	82.2 [3.24]	●	●	●	●										
	RPC-356	90	●		184 [7.24]	101.1 [3.98]	●	●	●	●	●									
	RPC-368	90	●		206 [8.11]	118 [4.65]	●	●	●	●	●									



CLICK OR SCAN

To view full catalog pages on this product

# PARALLEL GRIPPERS

## Sizing and Application Chart

Total Gripforce N [lbs]	Maximum Finger Length @ 60psi mm [in]	Actuation Time	Operating Pressure bar [psi]	Environ- ment	Features
0.45-45 [1-10]	0-50.8 [0-2]	0.05-0.1 sec.	5-100 [0.3-7]	Clean Room Environment	Three Jaw Grippers
45-111 [10-25]	50.8-102 [2-4]	0.1-0.5 sec.	20-100 [1.5-7]	Normal Environment	✓
111-223 [25-50]	102-152 [4-6]	0.5-0.75 sec.	30-100 [2-7]	Harsh/Dirty Environment	✓
223-445 [50-100]	152-203 [6-8]	0.75-1 sec.	40-100 [3-7]	Failsafe Operation	✓
445-2225 [100-500]	203-254 [8-10]		45-100 [3.1-7]	Inductive Sensors	✓
2225-13350 [500-3000]	254-305 [10-12]		50-100 [3.5-7]	Magneto Resistive Sensors	✓
	305-356 [12-14]		55-100 [3.8-7]	Double Acting Cylinder	✓
	356-406 [14-16]		60-100 [4-7]	Single Acting/Spring Return	✓
	406-457 [16-18]		70-150 [5-7]	Double Acting/Spring Assist	✓
	457-508 [18-20]			Non-Synchronous Option	✓
	508+ [20+]				

# ANGULAR GRIPPERS

## Sizing and Application Chart

CLICK OR SCAN

To view full catalog pages on this product

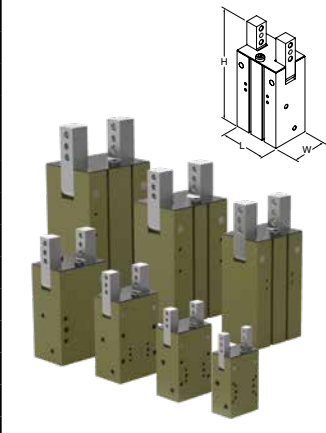
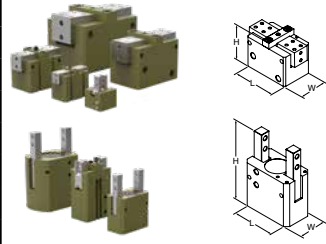
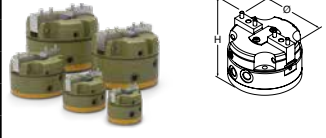
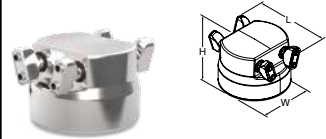

Series	Page #	Jaws		Basic Unit Dimensions mm [in]			Angle (Both Jaws)				Total Gripforce N [lbs]
		2 Jaws	3 Jaws	Length	Width	Height	12 Degrees	30 Degrees	70 Degrees	180 Degrees	0.45-45 [1-10] 45-111 [10-25] 111-223 [25-50] 223-445 [50-100] 445-2225 [100-500] 2225-13350 [500-3000]
<b>Angular Grippers</b>											
	CT-12M	92	●	30 [1.18]	20 [0.79]	48 [1.89]				●	●
	CT-12M-RE	92	●	30 [1.18]	20 [0.79]	64 [2.52]				●	●
	CT-16M	92	●	36 [1.42]	25 [0.98]	64 [2.52]				●	●
	CT-16M-RE	92	●	36 [1.42]	25 [0.98]	71 [2.80]				●	●
	CT-20M	92	●	42 [1.65]	30 [1.18]	79 [3.11]				●	●
	CT-20M-RE	92	●	42 [1.65]	30 [1.18]	83 [3.27]				●	●
	CT-25M	92	●	50 [1.97]	36 [1.42]	93.5 [3.68]				●	●
	CT-25M-RE	92	●	50 [1.97]	36 [1.42]	102 [4.02]				●	●
	CT-32M	92	●	56 [2.20]	42 [1.65]	95 [3.74]				●	●
	CT-32M-RE	92	●	56 [2.20]	42 [1.65]	116 [4.57]				●	●
	CT-40M	92	●	66 [2.60]	52 [2.05]	107.5 [4.23]				●	●
	CT-40M-RE	92	●	66 [2.60]	52 [2.05]	135 [5.31]				●	●
CT-50M	92	●	76 [2.99]	62 [2.44]	146 [5.75]				●	●	
CT-50M-RE	92	●	76 [2.99]	62 [2.44]	163 [6.42]				●	●	
	RA-5	94	●	25.4 [1.00]	38.1 [1.50]	35.0 [1.38]				●	●
	RA-6	94	●	38.1 [1.50]	50.8 [2.00]	49.6 [1.95]				●	●
	RA-7	94	●	50.8 [2.00]	76.2 [3.00]	60.8 [2.39]				●	●
	RA-8	94	●	76.2 [3.00]	101.6 [4.00]	76.2 [3.00]				●	●
	RA-10	94	●	25.4 [1.00]	25.4 [1.00]	20.7 [0.81]				●	●
	RA-15	96	●	25.4 [1.00]	44.5 [1.75]	38.9 [1.53]	●				●
RA-25	96	●	44.5 [1.75]	63.5 [2.50]	61.9 [2.44]	●				●	
RA-90	96	●	39 [1.54]	28 [1.10]	67.3 [2.65]			●		●	
	RUA-62M	98	●		Ø60 [Ø2.36]	53 [2.09]				●	●
	RUA-82M	98	●		Ø80 [Ø3.15]	57 [2.24]				●	●
	RUA-112M	98	●		Ø110 [Ø4.33]	175 [6.89]				●	●
	RUA-142M	98	●		Ø140 [Ø5.51]	107 [4.21]				●	●
	RUA-162M	98	●		Ø165 [Ø6.50]	119 [4.69]				●	●
	FUA-63M	100	●	100 [3.94]	90 [3.54]	62 [2.44]			●		●



**CLICK OR SCAN**

To view full catalog pages on this product

# ANGULAR GRIPPERS

## Sizing and Application Chart

Maximum Finger Length @ 60psi mm [in]	Actuation Time	Operating Pressure bar [psi]	Environment	Features																
				Angular Grippers																
0-50.8 [0-2]	0.05-0.1 sec.	30-100 [2-7]	Clean Room Environment																	
50.8-102 [2-4]	0.1-0.5 sec.	30-100 [2-7]	Normal Environment																	
102-152 [4-6]	0.5-0.75 sec.	45-100 [3.1-7]	Harsh/Dirty Environment																	
152-203 [6-8]	0.75-1 sec.	40-100 [3-7]	Failsafe Operation																	
203-254 [8-10]		50-100 [3.5-7]	Inductive Sensors																	
254-305 [10-12]		60-100 [4-7]	Magneto Resistive Sensors																	
305-356 [12-14]			Double Acting Cylinder																	
356-406 [14-16]			Single Acting/Spring Return																	
406-457 [16-18]			Double Acting/Spring Assist																	
457-508 [18-20]			Non-Synchronous Option																	
508+ [20+]																				



# ROTARY ACTUATORS

## Sizing and Application Chart

CLICK OR SCAN

To view full  
catalog pages  
on this product



Series	Page #	Ports/ Mounting		Rotary Type		Basic Unit Dimensions mm [in]			Maximum Torque Nm [in-lb]					
		Imperial	Metric	Flange Output	Shaft Output	Length	Width	Height	0-111 [0-25]	111-223 [25-50]	223-445 [50-100]	445-678 [100-150]	678-890 [150-200]	890-1335 [200-300]
<b>DRF- Flange Output</b>														
	<b>DRF-075M</b>	<b>102</b>		●	●	68 [2.69]	54 [2.13]	38.8 [1.52]	●					
	<b>DRF-094M</b>	<b>102</b>		●	●	85 [3.38]	71 [2.78]	44.8 [1.76]	●					
	<b>DRF-106M</b>	<b>102</b>		●	●	102 [4.54]	100 [3.94]	57.9 [2.28]	●					
	<b>DRF-131M</b>	<b>102</b>		●	●	153 [6.02]	133 [5.25]	71.7 [2.82]	●					
<b>DRG- Shaft Output</b>														
	<b>DRG-075M</b>	<b>104</b>		●	●	68 [2.69]	54 [2.13]	64 [2.51]	●					
	<b>DRG-094M</b>	<b>104</b>		●	●	85 [3.38]	71 [2.78]	76 [3.02]	●					
	<b>DRG-106M</b>	<b>104</b>		●	●	102 [4.54]	100 [3.94]	102 [4.01]	●					
	<b>DRG-131M</b>	<b>104</b>		●	●	153 [6.02]	133 [5.25]	128 [5.02]	●					
<b>RR-Light Duty</b>														
	<b>RR-18/-18M</b>	<b>106</b>	●	●	●	61 [2.42]	57.1 [2.25]	24.6 [.969]	●					
	<b>RR-28/-28M</b>	<b>106</b>	●	●	●	83.1 [3.28]	85.7 [3.375]	33.1 [1.313]	●					
<b>RR-Medium Duty</b>														
	<b>RR-36/-36M</b>	<b>108</b>	●	●	●	170.9 [6.73]	101.6 [4.00]	43.7 [1.72]	●					
	<b>RR-46/-46M</b>	<b>108</b>	●	●	●	203.2 [8.00]	113.5 [4.47]	54.1 [2.13]	●	●				
<b>RR-Heavy Duty</b>														
	<b>RR-56/-56M</b>	<b>110</b>	●	●	●	[8.50] 215.9	117.5 [4.63]	70.2 [2.77]	●	●				
	<b>RR-66/-66M</b>	<b>110</b>	●	●	●	[10.35] 262.8	158.8 [6.25]	96.8 [3.81]	●	●	●			
	<b>RR-76/-76M</b>	<b>110</b>	●	●	●	[13.19] 334.9	222.3 [8.75]	136.5 [5.38]	●	●	●	●		



**CLICK OR SCAN**

To view full catalog pages on this product

# ROTARY ACTUATORS

## Sizing and Application Chart

Degrees of Rotation	Maximum Payload Kg [lbs]	Maximum Inertia Nm sec <sup>2</sup> x 10 <sup>3</sup> [in-lbs sec <sup>2</sup> ]	Actuation Time 180°	Operating Pressure bar [psi]	Features
45°	0-10 [0-5]	0.0-0.1 [0.000-0.001]	0.05-0.1 sec.	2-7 [20-100]	Inductive Sensors
90°	10-25 [5-11]	0.1-0.6 [0.001-0.005]	0.1-0.5 sec.	3-7 [40-100]	Magneto Resistive Sensors
135°	25-50 [11-23]	0.6-1.1 [0.005-0.010]	0.5-0.75 sec.		Shock Absorbers
180°	50-100 [23-45]	1.1-2.8 [0.010-0.025]	0.75+ sec.		Mid-Stop
	100-150 [45-68]	2.8-5.7 [0.025-0.050]			Air Manifold
	150+ [68+]	5.7-11.3 [0.050-0.100]			High Temperature
		11.3-56.5 [0.100-0.500]			
		56.5-282.5 [0.500-2.500]			
		282.5-565 [2.500-5.000]			
<b>DRF- Flange Output</b>					
•	•	•	•	•	✓
•	•	•	•	•	✓
•	•	•	•	•	✓
•	•	•	•	•	✓
<b>DRG- Shaft Output</b>					
•	•	•	•	•	✓
•	•	•	•	•	✓
•	•	•	•	•	✓
•	•	•	•	•	✓
<b>RR-Light Duty</b>					
•	•	•	•	•	✓
•	•	•	•	•	✓
<b>RR-Medium Duty</b>					
•	•	•	•	•	✓
•	•	•	•	•	✓
<b>RR-Heavy Duty</b>					
•	•	•	•	•	✓
•	•	•	•	•	✓
•	•	•	•	•	✓

# LINEAR SLIDES

## Sizing and Application Chart

CLICK OR SCAN

To view full  
catalog pages  
on this product



	Series	Page #	Slide Type			Basic Unit Dimensions mm [in]			Maximum Thrust Force N [lbs]								
			Base Slide	Thru-ster Slide	Lift/Block Thru-ster	Length + Stroke	Width	Height	0-111 [0-25]	111-223 [25-50]	223-445 [50-100]	445-678 [100-150]	678-890 [150-200]	890-1335 [200-300]	1335+ [300+]		
<b>OEM Linear Slide</b>																	
	<b>T110-06M</b>	<b>37</b>	●	●		[224-6.10] 57-155	30 [1.18]	20 [0.79]	●								
	<b>T110-08M</b>	<b>37</b>	●	●		[2.56-9.13] 65-232	40 [1.57]	24 [0.94]	●								
	<b>T110-12M</b>	<b>37</b>	●	●		[3.50-12.24] 89-311	50 [1.97]	32 [1.26]	●	●							
	<b>T110-16M</b>	<b>37</b>	●	●		[3.78-15.12] 96-384	60 [2.36]	40 [1.57]	●	●	●						
	<b>T110-20M</b>	<b>37</b>	●	●		[4.17-18.46] 106-469	70 [2.76]	50 [1.97]	●	●	●						
	<b>T110-25M</b>	<b>37</b>	●	●		[4.61-18.11] 117-460	80 [3.15]	62 [2.44]	●	●	●						
<b>Base Slide-Internal Air Cylinder</b>																	
	<b>DLB-06M-B</b>	<b>112</b>	●			81 [3.19]	50.3 [1.98]	23.7 [0.93]	●								
	<b>DLB-08M-B</b>	<b>112</b>	●			93.7 [3.69]	62.7 [2.47]	23.7 [0.93]	●								
	<b>DLB-10M-B</b>	<b>112</b>	●			143 [5.63]	88.6 [3.49]	31.6 [1.24]	●	●							
	<b>DLB-12M-B</b>	<b>112</b>	●			155.7 [6.13]	101.2 [3.98]	42.1 [1.66]	●	●	●						
	<b>DLB-16M-B</b>	<b>112</b>	●			174.8 [6.88]	120.3 [4.74]	42.1 [1.66]	●	●	●						
	<b>DLB-20M-B</b>	<b>112</b>	●			239.3 [9.42]	164.6 [6.48]	55.4 [2.18]	●	●	●	●					
<b>DLB-25M-B</b>	<b>112</b>	●			275.3 [10.84]	190 [7.48]	55.4 [2.18]	●	●	●	●						
<b>Base Slide-Internal Air Cylinder-Long Stroke</b>																	
	<b>DLB-06M-L</b>	<b>112</b>	●			125.5 [4.94]	50.3 [1.98]	23.7 [0.93]	●								
	<b>DLB-08M-L</b>	<b>112</b>	●			138.2 [5.44]	62.7 [2.47]	23.7 [0.93]	●								
	<b>DLB-10M-L</b>	<b>112</b>	●			193.8 [7.63]	88.6 [3.49]	31.6 [1.24]	●	●							
	<b>DLB-12M-L</b>	<b>112</b>	●			219.2 [8.63]	101.2 [3.98]	42.1 [1.66]	●	●	●						
	<b>DLB-16M-L</b>	<b>112</b>	●			244.6 [9.63]	120.3 [4.74]	42.1 [1.66]	●	●	●						
	<b>DLB-20M-L</b>	<b>112</b>	●			290.1 [11.42]	164.6 [6.48]	55.4 [2.18]	●	●	●	●					
<b>DLB-25M-L</b>	<b>112</b>	●			326.1 [12.84]	190 [7.48]	55.4 [2.18]	●	●	●	●						
<b>Linear Thruster Slide-External Air Cylinder</b>																	
	<b>DLB-06M-T, U</b>	<b>115</b>	●			129.4 [5.09]	50.3 [1.98]	23.7 [0.93]	●								
	<b>DLB-08M-T, U</b>	<b>115</b>	●			142.1 [5.59]	62.7 [2.47]	23.7 [0.93]	●								
	<b>DLB-10M-A, U</b>	<b>115</b>	●			237.4 [9.35]	88.6 [3.49]	31.6 [1.24]	●	●							
	<b>DLB-12M-A, U</b>	<b>115</b>	●			253.6 [9.98]	101.2 [3.98]	42.1 [1.66]	●	●	●						
	<b>DLB-16M-A, U</b>	<b>115</b>	●			272.6 [10.73]	120.3 [4.74]	42.1 [1.66]	●	●	●						
	<b>DLB-20M-N, U</b>	<b>115</b>	●			337.3 [13.28]	164.6 [6.48]	56.8 [2.24]	●	●	●	●					
	<b>DLB-25M-N, U</b>	<b>115</b>	●			373.3 [14.70]	190 [7.48]	56.8 [2.24]	●	●	●	●					
	<b>DLB-20M-R, U</b>	<b>115</b>	●			377.9 [14.88]	164.6 [6.48]	56.8 [2.24]	●	●	●	●					
<b>DLB-25M-R, U</b>	<b>115</b>	●			413.9 [16.30]	190 [7.48]	56.8 [2.24]	●	●	●	●						



**CLICK OR SCAN**

To view full catalog pages on this product

# LINEAR SLIDES

## Sizing and Application Chart

Maximum Stroke mm [in]	Maximum Payload Kg [lbs]	Operating Pressure bar [psi]	Cylinder Type	Bearings	Features
0-50.8 [0-2]	0-10 [0-5]	100 [7]	Internal (Repairable)	Preloaded Ball Bushing	Telescopic Airlines
50.8-102 [2-4]	10-25 [5-11]	20-100 [1.4-7]	External (Replaceable)	Composite Bushing	Independent End Stops
102-152 [4-6]	25-50 [11-23]	22-100 [1.7-7]	External (Replaceable) with Air Cushions	Roller Bearing	Bumpers and Collars
152-203 [6-8]	50-100 [23-45]		External (VDMMA) Repairable with Air Cushions	Bronze Bushing	Shock Absorbers
203-254 [8-10]	100-150 [45-68]		External Locking (VDMMA) Repairable with Air Cushions	Inductive Sensors	Magneto Resistive Sensors
254-305 [10-12]	150+ [68+]		-U Non-powered		
305-356 [12-14]					
356-406 [14-16]					
406-457 [16-18]					
457-508 [18-20]					
508-558 [20-22]					
558-610 [22-24]					
610+ [24+]					
<b>OEM Linear Slide</b>					
•	•			•	✓
••	•			•	✓
••	•			•	✓
•••	•			•	✓
•••	••			•	✓
••••	••			•	✓
••••	•••			•	✓
•••••	•••			•	✓
•••••	••••			•	✓
•••••	••••			•	✓
<b>Base Slide-Internal Air Cylinder</b>					
•	•	•	•	•	✓
•	•	•	•	•	✓
•	••	•	•	•	✓
••	•••	•	•	•	✓
••	•••	•	•	•	✓
•••	••••	•	•	•	✓
•••	••••	•	•	•	✓
••••	•••••	•	•	•	✓
••••	•••••	•	•	•	✓
•••••	•••••	•	•	•	✓
•••••	•••••	•	•	•	✓
<b>Base Slide-Internal Air Cylinder-Long Stroke</b>					
••	•	•	•	•	✓
••	•	•	•	•	✓
••	••	•	•	•	✓
•••	•••	•	•	•	✓
•••	•••	•	•	•	✓
••••	••••	•	•	•	✓
••••	••••	•	•	•	✓
•••••	•••••	•	•	•	✓
•••••	•••••	•	•	•	✓
<b>Linear Thruster Slide-External Air Cylinder</b>					
•••	•	•	•	•	✓
•••	•	•	•	•	✓
••••	••	•	•	•	✓
••••	••	•	•	•	✓
•••••	•••	•	•	•	✓
•••••	•••	•	•	•	✓
•••••	••••	•	•	•	✓
•••••	••••	•	•	•	✓
•••••	•••••	•	•	•	✓
•••••	•••••	•	•	•	✓
•••••	•••••	•	•	•	✓
•••••	•••••	•	•	•	✓

# LINEAR SLIDES

## Sizing and Application Chart

CLICK OR SCAN

To view full  
catalog pages  
on this product



Series	Page #	Slide Type	Basic Unit Dimensions mm [in]			Maximum Thrust Force N [lbs]									
			Base Slide	Thruster Slide	Lift/Block Thruster	Length + Stroke	Width	Height	0-111 [0-25]	111-223 [25-50]	223-445 [50-100]	445-678 [100-150]	678-890 [150-200]	890-1335 [200-300]	1335+ [300+]
<b>Linear Thruster Slide—Internal Air Cylinder—Block Style</b>															
	<b>DLT-06M-B</b>	<b>118</b>	●	●	70.7 [2.78]	50.8 [2.00]	22.4 [0.88]	●							
	<b>DLT-08M-B</b>	<b>118</b>	●	●	83.4 [3.28]	63.5 [2.50]	22.4 [0.88]	●							
	<b>DLT-10M-B</b>	<b>118</b>	●	●	122.3 [4.81]	88.9 [3.50]	30.2 [1.19]	●	●						
	<b>DLT-12M-B</b>	<b>118</b>	●	●	135 [5.31]	101.6 [4.00]	41.4 [1.63]	●	●	●					
	<b>DLT-16M-B</b>	<b>118</b>	●	●	155.6 [6.13]	120.7 [4.75]	41.4 [1.63]	●	●	●	●				
	<b>DLT-20M-B</b>	<b>118</b>	●	●	214.9 [8.46]	165.1 [6.50]	55.9 [2.20]	●	●	●	●	●			
	<b>DLT-25M-B</b>	<b>118</b>	●	●	245.6 [9.67]	190.5 [7.50]	55.9 [2.20]	●	●	●	●	●	●		
<b>Linear Thruster Slide—Internal Air Cylinder—Extended Stroke</b>															
	<b>DLT-06M-E</b>	<b>118</b>	●		87.5 [3.44]	50.8 [2.00]	22.4 [0.88]	●							
	<b>DLT-08M-E</b>	<b>118</b>	●		93.8 [3.69]	63.5 [2.50]	22.4 [0.88]	●							
	<b>DLT-10M-E</b>	<b>118</b>	●		143.1 [5.63]	88.9 [3.50]	30.2 [1.19]	●	●						
	<b>DLT-12M-E</b>	<b>118</b>	●		155.8 [6.13]	101.6 [4.00]	41.4 [1.63]	●	●	●					
	<b>DLT-16M-E</b>	<b>118</b>	●		174.9 [6.89]	120.7 [4.75]	41.4 [1.63]	●	●	●	●				
	<b>DLT-20M-E</b>	<b>118</b>	●		239.3 [9.42]	165.1 [6.50]	55.9 [2.20]	●	●	●	●	●			
	<b>DLT-25M-E</b>	<b>118</b>	●		275.3 [10.84]	190.5 [7.50]	55.9 [2.20]	●	●	●	●	●	●		
<b>Linear Thruster Slide—Internal Air Cylinder—Long Body</b>															
	<b>DLT-06M-L</b>	<b>118</b>	●		115.1 [4.53]	50.8 [2.00]	22.4 [0.88]	●							
	<b>DLT-08M-L</b>	<b>118</b>	●		127.8 [5.03]	63.5 [2.50]	22.4 [0.88]	●							
	<b>DLT-10M-L</b>	<b>118</b>	●		173.1 [6.81]	88.9 [3.50]	30.2 [1.19]	●	●						
	<b>DLT-12M-L</b>	<b>118</b>	●		198.5 [7.81]	101.6 [4.00]	41.4 [1.63]	●	●	●					
	<b>DLT-16M-L</b>	<b>118</b>	●		225.5 [8.88]	120.7 [4.75]	41.4 [1.63]	●	●	●	●				
	<b>DLT-20M-L</b>	<b>118</b>	●		271.8 [10.70]	165.1 [6.50]	55.9 [2.20]	●	●	●	●	●			
	<b>DLT-25M-L</b>	<b>118</b>	●		297.2 [11.70]	190.5 [7.50]	55.9 [2.20]	●	●	●	●	●	●		
<b>Linear Thruster Slide—External Air Cylinder</b>															
	<b>DLT-06M-T, U</b>	<b>121</b>	●		125.6 [4.94]	50.8 [2.00]	22.4 [0.88]	●							
	<b>DLT-08M-T, U</b>	<b>121</b>	●		138.3 [5.44]	63.5 [2.50]	22.4 [0.88]	●							
	<b>DLT-10M-A, U</b>	<b>121</b>	●		210.3 [8.28]	88.9 [3.50]	30.2 [1.19]	●	●						
	<b>DLT-12M-A, U</b>	<b>121</b>	●		226.5 [8.92]	101.6 [4.00]	41.4 [1.63]	●	●	●					
	<b>DLT-16M-A, U</b>	<b>121</b>	●		247.1 [9.73]	120.7 [4.75]	41.4 [1.63]	●	●	●	●				
	<b>DLT-20M-N, U</b>	<b>121</b>	●		322.6 [12.70]	165.1 [6.50]	55.9 [2.20]	●	●	●	●	●			
	<b>DLT-25M-N, U</b>	<b>121</b>	●		353.3 [13.91]	190.5 [7.50]	55.9 [2.20]	●	●	●	●	●	●		
	<b>DLT-20M-R, U</b>	<b>121</b>	●		363.2 [14.30]	165.1 [6.50]	55.9 [2.20]	●	●	●	●	●	●		
	<b>DLT-25M-R, U</b>	<b>121</b>	●		393.9 [15.51]	190.5 [7.50]	55.9 [2.20]	●	●	●	●	●	●	●	



CLICK OR SCAN

To view full catalog pages on this product

# LINEAR SLIDES

## Sizing and Application Chart

Maximum Stroke mm [in]	Maximum Payload Kg [lbs]	Operating Pressure bar [psi]	Cylinder Type	Bearings	Features
0-50.8 [0-2] 50.8-102 [2-4] 102-152 [4-6] 152-203 [6-8] 203-254 [8-10] 254-305 [10-12] 305-356 [12-14] 356-406 [14-16] 406-457 [16-18] 457-508 [18-20] 508-558 [20-22] 558-610 [22-24] 610+ [24+]	0-10 [0-5] 10-25 [5-11] 25-50 [11-23] 50-100 [23-45] 100-150 [45-68] 150+ [68+]	100 [7] 20-100 [1.4-7] 22-100 [1.7-7]	Internal (Repairable) External (Replaceable) External (Replaceable) with Air Cushions External (VDMA) Repairable with Air Cushions External Locking (VDMA) Repairable with Air Cushions -U Non-powered	Preloaded Ball Bushing Composite Bushing Roller Bearing Bronze Bushing	Inductive Sensors Magneto Resistive Sensors Shock Absorbers Bumpers and Collars Independent End Stops Telescopic Airlines
<b>Linear Thruster Slide-Internal Air Cylinder-Block Style</b>					
<b>Linear Thruster Slide-Internal Air Cylinder-Extended Stroke</b>					
<b>Linear Thruster Slide-Internal Air Cylinder-Long Body</b>					
<b>Linear Thruster Slide-External Air Cylinder</b>					

# LINEAR SLIDES

## Sizing and Application Chart

CLICK OR SCAN

To view full catalog pages on this product



	Series	Page #	Slide Type			Basic Unit Dimensions mm [in]			Maximum Thrust Force N [lbs]									
			Base Slide	Thruster Slide	Lift/Block Thruster	Length	Width	Height	0-111 [0-25]	111-223 [25-50]	223-445 [50-100]	445-678 [100-150]	678-890 [150-200]	890-1335 [200-300]	1335+ [300+]			
<b>Miniature Rail Thruster Slide</b>																		
	DLM-07M-12	124	●			78 [3.07]	21 [0.83]	35.5 [1.40]	●									
	DLM-07M-25	124	●			102 [4.02]	21 [0.83]	35.5 [1.40]	●									
	DLM-07M-38	124	●			115 [4.53]	21 [0.83]	35.5 [1.40]	●									
	DLM-07M-50	124	●			127 [5.00]	21 [0.83]	35.5 [1.40]	●									
	DLM-09M-25	124	●			113 [4.45]	32 [1.26]	62 [2.44]	●	●								
	DLM-09M-50	124	●			159 [6.26]	32 [1.26]	62 [2.44]	●	●								
	DLM-09M-75	124	●			184 [7.24]	32 [1.26]	62 [2.44]	●	●								
	DLM-09M-100	124	●			209 [8.23]	32 [1.26]	62 [2.44]	●	●								
	DLM-12M-50	124	●			126 [4.96]	32 [1.26]	65 [2.56]	●	●	●							
	DLM-12M-75	124	●			166 [6.54]	32 [1.26]	65 [2.56]	●	●	●							
DLM-12M-50	124	●			193 [7.60]	32 [1.26]	65 [2.56]	●	●	●								
DLM-12M-100	124	●			218 [8.58]	32 [1.26]	65 [2.56]	●	●	●								
	MPS-1M-1	126	●			46 [1.81]	20.6 [0.81]	31.8 [1.25]	●									
	MPS-1M-2	126	●			63.4 [2.50]	20.6 [0.81]	31.8 [1.25]	●									
	MPS-1M-3	126	●			88.9 [3.50]	20.6 [0.81]	31.8 [1.25]	●									
	MPS-1M-4	126	●			113 [4.45]	20.6 [0.81]	31.8 [1.25]	●									
	MPS-2M-1	126	●			46 [1.81]	27 [1.06]	39.7 [1.56]	●	●								
	MPS-2M-2	126	●			64.4 [2.54]	27 [1.06]	39.7 [1.56]	●	●								
	MPS-2M-3	126	●			88.9 [3.50]	27 [1.06]	39.7 [1.56]	●	●								
	MPS-2M-4	126	●			113 [4.45]	27 [1.06]	39.7 [1.56]	●	●								

# FEED ESCAPEMENTS

CLICK OR SCAN

To view full catalog pages on this product



	Series	Page #	Shaft	Basic Unit Dimensions mm [in]			Max. Thrust Force N [lbs]	Maximum Stroke mm [in]	Operating Pressure bar [psi]	Cylinder Type	Features			
				Dual Shaft	Single Shaft	Length					Width	Height	Internal (Repairable)	Hall Effect Sensors
<b>Vereinzeler</b>														
	RFE-1	128	●		117 [4.59]	38.1 [1.50]	19.1 [0.75]	●		●	●	✓	✓	✓
	RFE-2	128	●		162 [6.39]	57.2 [2.25]	24.9 [0.98]	●		●	●	✓	✓	✓
	RFE-3	128	●		197 [7.74]	69.9 [2.75]	34.5 [1.36]	●		●	●	✓	✓	✓
	RN-1	130	●		116 [4.59]	22.2 [0.88]	19.1 [0.75]	●		●	●	✓	✓	✓
	RN-2	130	●		161 [6.34]	28.6 [1.13]	24.9 [0.98]	●		●	●	✓	✓	✓
	RN-2	130	●		195 [7.70]	34.9 [1.38]	34.5 [1.36]	●		●	●	✓	✓	✓





# G110 SERIES

## OEM Parallel Grippers

### How To Order

CLICK OR SCAN

To view full catalog pages on this product

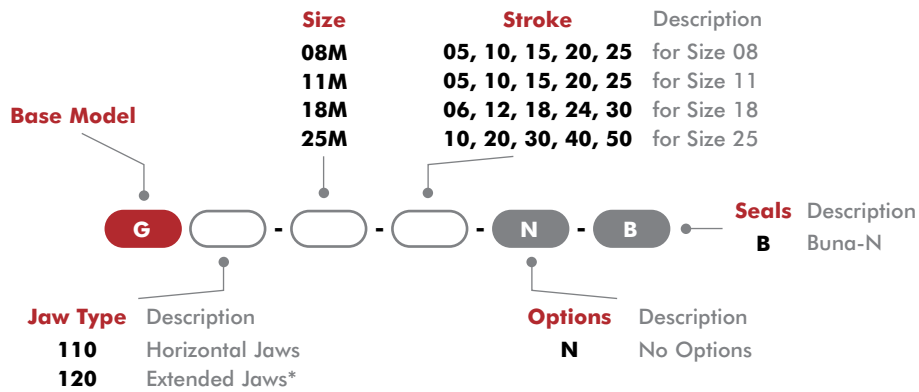

## Basic Unit Dimensions

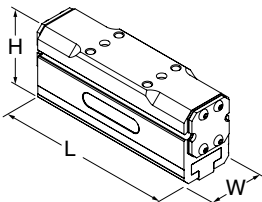

Size	L	W	H
G110-08M	43-103 [1.69-4.06]	20 [0.79]	28 [1.10]
G110-11M	43-103 [1.69-4.06]	24 [0.94]	36.5 [1.44]
G110-18M	54-125 [2.13-4.92]	30 [1.18]	43 [1.69]
G110-25M	73-193 [2.87-7.60]	40 [1.57]	61 [2.40]



**CLICK OR SCAN**  
To view full  
catalog pages  
on this product

# G110 SERIES

## OEM Parallel Grippers

### Technical Data

Specifications	Units	08M-05	08M-10	08M-15	08M-20	08M-25
Total Rated Grip Force	N [lbf]	56 [13]				
Stroke	mm [in]	5 [0.20]	10 [0.39]	15 [0.59]	20 [0.79]	25 [0.98]
Weight	kg [lbs]	0.06 [0.13]	0.09 [0.20]	0.11 [0.24]	0.14 [0.31]	0.17 [0.37]
Pressure Range	bar [psi]	3-7 [40-100]				
Displacement	cc [cu-in]	0.3 [0.02]	0.5 [0.03]	0.7 [0.05]	1.0 [0.06]	1.2 [0.08]
Cylinder Bore Diameter	mm [in]	8 [0.31]				
Temperature Range (Buna-N)	°C [°F]	-35°~80° [-30°~180°]				
Actuation (open/close)	sec.	0.06	0.07	0.08	0.09	0.10

Specifications	Units	11M-05	11M-10	11M-15	11M-20	11M-25
Total Rated Grip Force	N [lbf]	104 [23]				
Stroke	mm [in]	5 [0.20]	10 [0.39]	15 [0.59]	20 [0.79]	25 [0.98]
Weight	kg [lbs]	0.09 [0.20]	0.13 [0.29]	0.17 [0.37]	0.21 [0.46]	0.25 [0.55]
Pressure Range	bar [psi]	3-7 [40-100]				
Displacement	cc [cu-in]	0.5 [0.03]	1.0 [0.06]	1.5 [0.09]	1.9 [0.12]	1.2 [0.15]
Cylinder Bore Diameter	mm [in]	11 [0.44]				
Temperature Range (Buna-N)	°C [°F]	-35°~80° [-30°~180°]				
Actuation (open/close)	sec.	0.08	0.09	0.10	0.1	0.12

Specifications	Units	18M-06	18M-12	18M-18	18M-24	18M-30
Total Rated Grip Force	N [lbf]	260 [58]				
Stroke	mm [in]	6 [0.24]	12 [0.47]	18 [0.71]	24 [0.94]	25 [0.98]
Weight	kg [lbs]	0.20 [0.44]	0.22 [0.48]	0.28 [0.62]	0.34 [0.75]	0.41 [0.90]
Pressure Range	bar [psi]	3-7 [40-100]				
Displacement	cc [cu-in]	1.5 [0.09]	2.9 [0.18]	4.3 [0.26]	5.8 [0.35]	7.2 [0.44]
Cylinder Bore Diameter	mm [in]	17.5 [0.69]				
Temperature Range (Buna-N)	°C [°F]	-35°~80° [-30°~180°]				
Actuation (open/close)	sec.	0.09	0.13	0.17	0.21	0.25

Specifications	Units	25M-10	25M-20	25M-30	25M-40	25M-50
Total Rated Grip Force	N [lbf]	558 [125]				
Stroke	mm [in]	10 [0.39]	20 [0.79]	30 [1.18]	40 [1.57]	50 [1.97]
Weight	kg [lbs]	0.42 [0.92]	0.64 [1.41]	0.85 [1.87]	1.03 [2.27]	1.22 [2.68]
Pressure Range	bar [psi]	3-7 [40-100]				
Displacement	cc [cu-in]	5.06 [0.31]	10.12 [0.62]	15.19 [0.93]	20.3 [1.24]	25.31 [1.55]
Cylinder Bore Diameter	mm [in]	25 [1.00]				
Temperature Range (Buna-N)	°C [°F]	-35°~80° [-30°~180°]				
Actuation (open/close)	sec.	0.28	0.36	0.44	0.52	0.61

# G110 SERIES

## OEM Parallel Grippers

CLICK OR SCAN

To view full catalog pages on this product



### Accessories

Sensor Accessories	Model Numbers	Part Number	Qty/Unit
Sensor, NPN magneto resistive type, 4mm Barrel	All Models	OHSN-021	1-4
Sensor, PNP magneto resistive type, 4mm Barrel	All Models	OHSP-021	1-4
Cable straight, quick disconnect, socket, 3 conductor, 2M length	All Models	CABL-010	1-4

\*Sensor and cable sold separately.

Power, Seal and Finger Mounting Accessories	08M	11M	18M	25M	Qty/Unit
Pneumatic air fitting	PLFT-021		PLFT-041		2
Valve kit, failsafe	N/A		OFSV-004		1
Jaw locating sleeve for precise finger mounting	20961-11		20962-11	20963-11	4
Seal Kit (includes): End gasket (Qty 2) Seal: U-cup Buna replacement seal (Qty 4) Button head socket cap screws (Qty 8)	SLKT-244	SLKT-245	SLKT-246	SLKT-247	1

### Commissioning Kits for Easy Ordering



2 Sensors



2 Air Fittings



4 Jaw Locating Finger Sleeves



4 Finger Mounting Screws

Commissioning Kits for:	Part Number
G110-08M, G120-08M	G110-QKST-101
G110-11M, G120-11M	G110-QKST-102
G110-18M, G120-18M	G110-QKST-103
G110-25M, G120-25M	G110-QKST-104

### G120 Extended Jaw Option, Finger Interchangeability Table\*

(G120 units ship with extended jaw option installed)



Extended Jaw Option Part Number	Mounts to G110 Series Part Number	Compatible with SMC Part Number
G110-FNGR-08M-05	G110-08M-05-N-B	MHZ2-10
G110-FNGR-08M-10	G110-08M-10-N-B	MHZL2-10
G110-FNGR-11M-05	G110-11M-05-N-B	MHZ2-16
G110-FNGR-11M-10	G110-11M-10-N-B	MHZL2-16
G110-FNGR-18M-12	G110-18M-12-N-B	MHZ2-25
G110-FNGR-18M-24	G110-18M-24-N-B	MHZL2-25
G110-FNGR-25M-20	G110-25M-20-N-B	MHZ2-32

\*Verify acceptable stroke and force changes in the table above for your application. G120 units are shipped with the extended jaw option mounted from factory. SMC is a registered trademark of SMC Corporation.



**CLICK OR SCAN**

To view full catalog pages on this product

# T110 SERIES

OEM Linear Slide

## How To Order

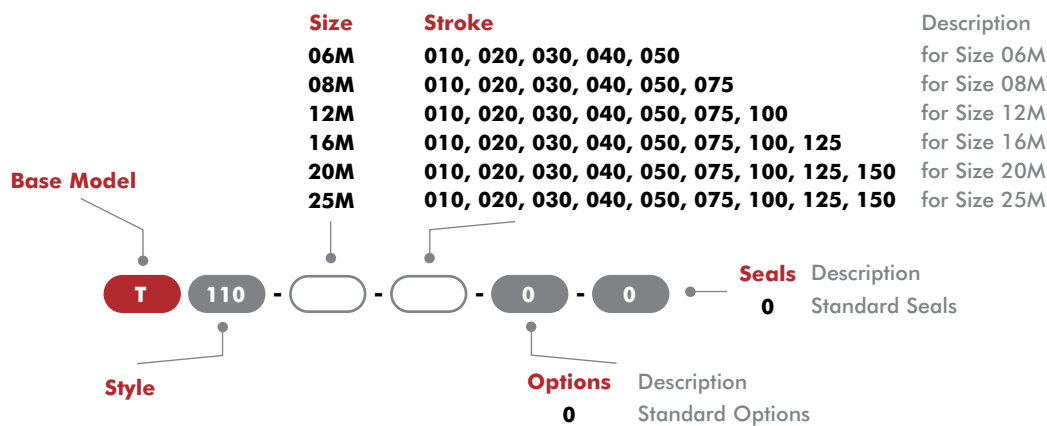

## Basic Unit Dimensions

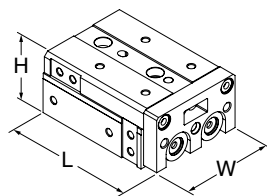

Size	L	W	H
T110-06M	57-155 [224-6.10]	30 [1.18]	20 [0.79]
T110-08M	65-232 [2.56-9.13]	40 [1.57]	24 [0.94]
T110-12M	89-311 [3.50-12.24]	50 [1.97]	32 [1.26]
T110-16M	96-384 [3.78-15.12]	60 [2.36]	40 [1.57]
T110-20M	106-469 [4.17-18.46]	70 [2.76]	50 [1.97]
T110-25M	117-460 [4.61-18.11]	80 [3.15]	62 [2.44]

## Basic Unit Technical Data

Specifications		Units	06M	08M	12M	16M	20M	25M
Thrust Force at 7 bar [100 psi]	Retract	N [lbf]	29 [6.51]	53 [11.9]	119 [26.8]	211 [47.4]	330 [74.2]	529 [119.0]
	Extend		40 [9.0]	71 [16.0]	158 [35.6]	281 [63.2]	440 [99.0]	687 [154.5]
Pressure Range		bar [psi]	1.5-7 [22-100]					
Cylinder Bore Diameter [x2]		mm [in]	6 [0.23]	8 [0.31]	12 [0.47]	16 [0.63]	20 [0.78]	25 [0.98]
Speed Range		mm/sec [in/sec]	50-500 [2-20]					

# T110 SERIES

## OEM Linear Slide

CLICK OR SCAN

To view full  
catalog pages  
on this product



### Technical Data

T110-06M		Units	-10	-20	-30	-40	-50
Stroke	mm (in)		10 [0.39]	20 [0.79]	30 [1.18]	40 [1.57]	50 [1.97]
Weight	kg (lb)		0.08 [0.178]	0.1 [0.222]	0.12 [0.256]	0.16 [0.344]	0.18 [0.4]
Displacement	cc (cu-in)		0.57 [0.035]	1.13 [0.069]	1.70 [0.104]	2.26 [0.138]	2.83 [0.173]
Max. Applied Load	N (lbf)		5 [1.124]				

T110-08M		Units	-10	-20	-30	-40	-50	-75
Stroke	mm [in]		10 [0.39]	20 [0.79]	30 [1.18]	40 [1.57]	50 [1.97]	75 [2.95]
Weight	kg [lb]		0.15 [0.333]	0.16 [0.356]	0.19 [0.422]	0.24 [0.522]	0.29 [0.633]	0.41 [0.911]
Displacement	cc [cu-in]		1.01 [0.061]	2.01 [0.123]	3.02 [0.184]	4.02 [0.245]	5.03 [0.307]	7.54 [0.460]
Max. Applied Load	N [lbf]		10 [2.248]					

T110-12M		Units	-10	-20	-30	-40	-50	-75	-100
Stroke	mm [in]		10 [0.39]	20 [0.79]	30 [1.18]	40 [1.57]	50 [1.97]	75 [2.95]	100 [3.94]
Weight	kg [lb]		0.33 [0.722]	0.33 [0.722]	0.33 [0.722]	0.39 [0.856]	0.48 [1.067]	0.66 [1.467]	0.89 [1.978]
Displacement	cc [cu-in]		2.26 [0.138]	4.52 [0.276]	6.79 [0.414]	9.05 [0.552]	11.31 [0.690]	16.97 [1.035]	22.62 [1.381]
Max. Applied Load	N [lbf]		20 [4.496]						

T110-16M		Units	-10	-20	-30	-40	-50	-75	-100	-125
Stroke	mm [in]		10 [0.39]	20 [0.79]	30 [1.18]	40 [1.57]	50 [1.97]	75 [2.95]	100 [3.94]	125 [4.92]
Weight	kg [lb]		0.57 [1.267]	0.57 [1.267]	0.58 [1.289]	0.64 [1.422]	0.76 [1.689]	1.09 [2.422]	1.37 [3.044]	1.70 [3.778]
Displacement	cc [cu-in]		4.02 [0.245]	8.04 [0.491]	12.07 [0.736]	16.09 [0.982]	20.11 [1.227]	30.16 [1.841]	40.22 [2.454]	50.27 [3.068]
Max. Applied Load	N [lbf]		35 [7.868]							

T110-20M		Units	-10	-20	-30	-40	-50	-75	-100	-125	-150
Stroke	mm [in]		10 [0.39]	20 [0.79]	30 [1.18]	40 [1.57]	50 [1.97]	75 [2.95]	100 [3.94]	125 [4.92]	150 [5.91]
Weight	kg [lb]		0.96 [2.133]	0.98 [2.178]	1.01 [2.244]	1.10 [2.44]	1.25 [2.778]	1.63 [3.622]	2.15 [4.778]	2.67 [5.933]	3.19 [7.089]
Displacement	cc [cu-in]		6.28 [0.383]	12.57 [0.767]	18.85 [1.150]	25.14 [1.534]	31.42 [1.917]	47.13 [2.876]	62.84 [3.838]	78.55 [4.793]	94.26 [5.752]
Max. Applied Load	N [lbf]		55 [12.364]								

T110-25M		Units	-10	-20	-30	-40	-50	-75	-100	-125	-150
Stroke	mm [in]		10 [0.39]	20 [0.79]	30 [1.18]	40 [1.57]	50 [1.97]	75 [2.95]	100 [3.94]	125 [4.92]	150 [5.91]
Weight	kg [lb]		1.66 [3.689]	1.68 [3.733]	1.69 [3.756]	1.84 [4.089]	2.09 [4.644]	2.65 [5.889]	3.27 [7.267]	4.14 [9.1]	4.71 [10.467]
Displacement	cc [cu-in]		9.82 [0.599]	19.64 [1.198]	29.46 [1.798]	39.28 [2.397]	49.09 [2.996]	73.645 [4.494]	98.19 [5.992]	122.73 [7.490]	147.28 [8.922]
Max. Applied Load	N [lbf]		70 [15.737]								



**CLICK OR SCAN**

To view full catalog pages on this product

# T110 SERIES

OEM Linear Slide

## Accessories

Sensor Accessories	Model Numbers	Part Number	Qty/Unit
Sensor, NPN magneto resistive type, 4mm Barrel	All Models	OHSN-021	1-2
Sensor, PNP magneto resistive type, 4mm Barrel	All Models	OHSP-021	1-2
Cable straight, quick disconnect, socket, 3 conductor, 2M length	All Models	CABL-010	1-2

\*Sensor and cable sold separately.

Power, Stop, Shock & Seals Accessories	06M	08M	12M	16M	20M	25M	Qty/Unit
Adjustable Flow Control, 6mm OD Tube	VLVF-008			VLVF-005			1-2
Stop Adjuster Kit, Extend	OSAK-088	OSAK-089	OSAK-090	OSAK-091	OSAK-092	OSAK-093	1
Stop Adjuster Kit, Retract	OSAK-094	OSAK-095	OSAK-096	OSAK-097	OSAK-098	OSAK-099	1
Shock Absorber Kit, Extend	N/A	OSAK-123	OSAK-124	OSAK-125	OSAK-126	OSAK-127	1
Shock Absorber Kit, Retract		OSAK-128	OSAK-129	OSAK-130	OSAK-131	OSAK-132	1
Spare Shock Absorber		SHOK-057	SHOK-057	SHOK-059	SHOK-060	SHOK-061	1
Seal Repair Kit (includes: Piston Seal, Retainer C-clip, Rod Seal, O-ring, Bumper)	SLKT-248	SLKT-249	SLKT-250	SLKT-251	SLKT-252	SLKT-253	1

## Commissioning Kits for Easy Ordering

2 Sensors



2 Cables



2 Adjustable Flow Controls



1 Shock Kit, Retract



1 Shock Kit, Extend

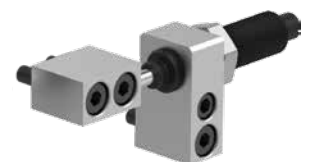

Commissioning Kits for:	Part Number
T110-06M	T110-QKST-101
T110-08M	T110-QKST-102
T110-12M	T110-QKST-103
T110-16M	T110-QKST-104
T110-20M	T110-QKST-105
T110-25M	T110-QKST-106

# DPE-400 HEAVY-DUTY

## Electric Parallel Grippers

CLICK OR SCAN

To view full catalog pages on this product



### How To Order

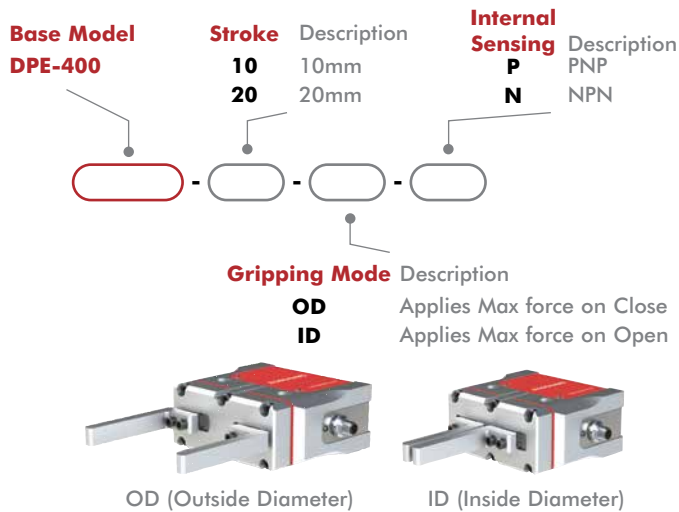

Shown with customer supplied fingers.

### Basic Unit Dimensions

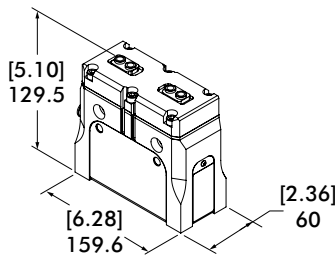

### Accessories

Power and Sensor Accessories	Part Number
PNP Magneto-Resistive Position Sensor	OHSP-017
NPN Magneto-Resistive Position Sensor	OHSN-017
Quick Disconnect Sensor Cable, 5m long	CABL-013
8-wire Power and Signal Cable, 5m long w/Straight M12 Connector	CABL-052
8-wire Power and Signal Cable, 5m long w/90° M12 Connector	CABL-053

\*Sensor and cable sold separately.

Specifications	Units	DPE-400
Total Rated Grip Force:		
DPE-400-10	N [lbf]	667-1334 [150-300]
DPE-400-20	N [lbf]	445-890 [100-200]
Total Stroke:		
DPE-400-10	mm [in]	10 [0.39]
DPE-400-20	mm [in]	20 [0.78]
Actuation Time	ms	800
Temperature Range	°C [°F]	0~55° [32°~131°]
Power Requirements @ 100% Duty Cycle	watts	10
Voltage	VDC	24
DC Current (Peak)	amps	2 (max)
DC Current: (Continuous)	amps	0.4
Ingress Protection Class (IP)		IP50
Clean Room		100 (Magnalube)
Weight	kg [lbs]	2.52 [5.56]
Maximum Finger Length	mm [in]	125 [4.92]
Durability	cycles	3 Million



CLICK OR SCAN

To view full catalog pages on this product

# DPE-200 MEDIUM-DUTY

Electric Parallel Grippers

## How To Order



Shown with customer supplied fingers.

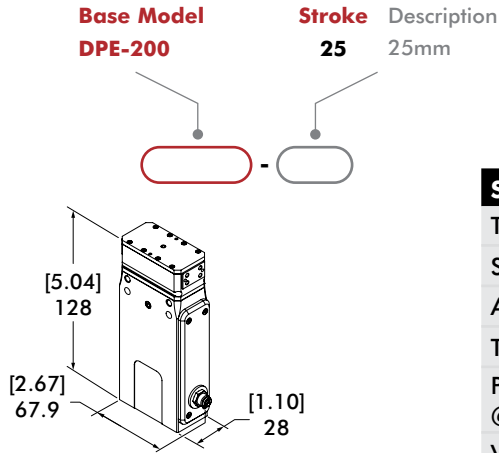

Specifications	Units	DPE-200-25
Total Grip Force	N [lbf]	111 [25]
Stroke	mm [in]	25 [0.98]
Actuation Time	ms	250
Temperature Range	°C [°F]	5°~60° [41°~140°]
Power Requirement @ 100% duty cycle	W	4.2
Voltage	VDC	24
Current - Peak	amps	1.5 (max)
Current - Continuous	amps	0.175
Ingress Protection Class (IP)		IP54
Clean Room		1000 (Krytox)
Weight	kg [lbs]	0.53 [1.16]
Max Finger Length	mm [in]	76.2 [3.00]
Durability	cycles	20 Million

## Accessories

Power and Sensor Accessories	Part Number
PNP Magneto-Resistive Position Sensor	OHSP-017
NPN Magneto-Resistive Position Sensor	OHSN-017
Quick Disconnect Sensor Cable, 5m Long	CABL-013
4-wire Power and Signal Cable, 5m Long	CABL-046

\* Sensor and cable sold separately.

## How To Order



Shown with customer supplied fingers.

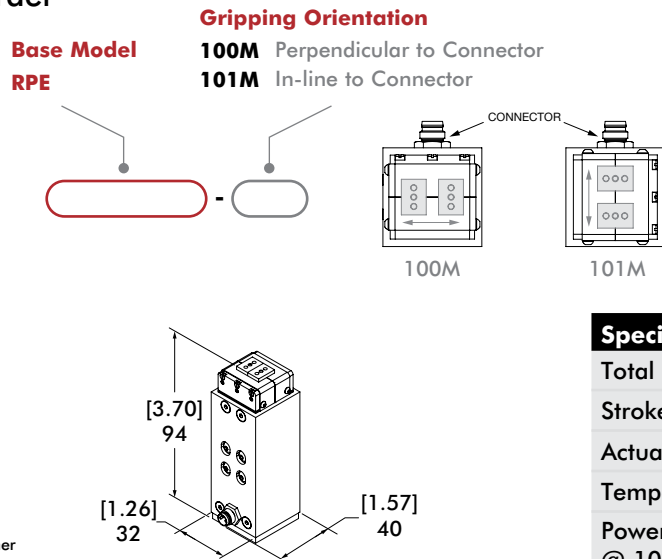

# RPE-100 LIGHT-DUTY



Specifications	Units	RPE-100M/101M
Total Grip Force	N [lbf]	5 [1.1]
Stroke	mm [in]	4 [0.16]
Actuation Time	ms	100
Temperature Range	°C [°F]	5°~50° [40°~120°]
Power Requirement @ 100% duty cycle	W	40 (Peak)
Voltage	VDC	24
Current - Peak	amps	1.5 (max)
Current - Continuous	amps	0.175
Ingress Protection Class (IP)		IP54
Clean Room		100 (Krytox)
Weight	kg [lbs]	0.23 [0.50]
Max Finger Length	mm [in]	50 [1.90]
Durability	cycles	5 Million

## Accessories

Sensor Accessories	Part Number
Sensor Mounting Kit (Mounts 1 sensor)	OSMK-130
PNP Inductive Sensor with Quick Connect	OISP-019
NPN Inductive Sensor with Quick Connect	OISN-019
Quick Disconnect Sensor Cable, 2m long	CABL-010
Quick Disconnect Sensor Cable, 5m long	CABL-013

\* Sensor and cable sold separately.



# 2P SERIES

## 2-Jaw Precision Parallel Grippers

CLICK OR SCAN

To view full catalog pages on this product



### How To Order



Note: See catalog for complete options information.

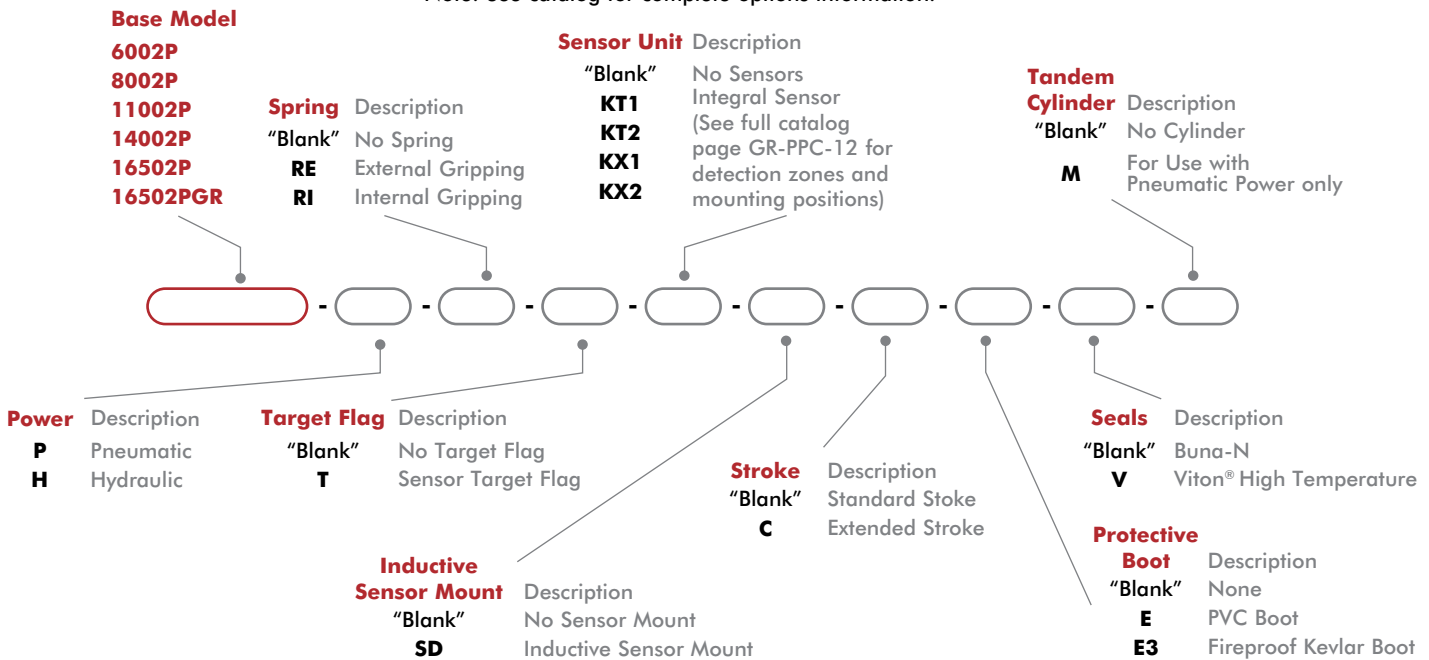

Size	Seal Repair Kits			Protective Boots	
	Buna-N	Viton®	Hydraulic	PVC - Brown or Black	Fireproof KEVLAR - Red
6002P	SLKT-156	SLKT-156V	SLKT-330	ER62P	E3R62P
8002P	S80	S80V	S80H	ER82P	E3R82P
11002P	S100	S110V	S110H	ER112P	E3R112P
14002P	SLKT-333	SLKT-333	SLKT-334	KP-311	KP-313
16502P	SLKT-335	SLKT-335V	SLKT-336	KP-314	KP-316
16502PGR				N/A	KENVE2-21384



**CLICK OR SCAN**  
To view full  
catalog pages  
on this product

# 2P SERIES

## 2-Jaw Precision Parallel Grippers

### Basic Unit Dimensions

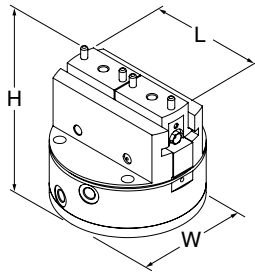

Size	L	L -C	W	H
6002P	72 [2.83]	78 [3.07]	60 [2.36]	77 [3.03]
8002P	91.6 [3.61]	98.4 [3.87]	80 [3.15]	78 [3.07]
11002P	126 [4.96]	136 [5.35]	110 [4.33]	106 [4.17]
14002P	165 [6.50]	179 [7.05]	140 [5.51]	137 [5.39]
16502P	194 [7.64]	204 [8.03]	165 [6.50]	169 [6.65]
16502PGR	210 [8.27]	--	165 [6.50]	262 [10.31]

### Technical Data

Specifications	Units	6002P-P	6002P-P-C	8002P-P	8002P-P-C	11002P-P	11002P-P-C
Grip Force (F6+R)1, 6 bar [87 psi], Springs Mid-Way, L=0	N [lb]	694 [156]	432 [97]	1946 [437]	1256 [282]	3043 [684]	2030 [456]
Grip Force (F0+R)2, 0 bars, Springs Mid-Way, L=0	N [lb]	176 [40]	109 [24]	635 [143]	410 [92]	965 [217]	644 [145]
Total Stroke	mm [in]	10 [0.39]	16 [0.63]	13 [0.51]	20 [0.79]	20 [0.79]	30 [1.18]
Weight	kg [lbs]	0.51 [1.12]		0.84 [1.85]		2.04 [4.50]	
Pressure Range	bar [psi]	w/Spring 2-7 Bar [30-100 psi], w/o spring 4-7 Bar [60-100 psi]					
Displacement	cm <sup>3</sup> [in <sup>3</sup> ]	12 [0.73]		35 [2.14]		87 [5.31]	
Temperature Range		Buna-N -35°~80° [-30°~180°], Viton® -30°~150° [-20°~300°]					
Actuation (open/close)	sec	0.07		0.08		0.10	

Specifications	Units	14002P-P	14002P-P-C	16502P-P	16502P-P-C	1650PGR-P	
Grip Force (F6+R)1, 6 bar [87 psi], Springs Mid-Way, L=0	N [lb]	6232 [1400]	4031 [906]	11475 [2579]	6878 [1546]	11475 [2579]	
Grip Force (F0+R)2, 0 bars, Springs Mid-Way, L=0	N [lb]	2305 [518]	1490 [335]	3825 [860]	2292 [515]	3825 [860]	
Total Stroke	mm [in]	26 [1.02]	40 [1.57]	30 [1.18]	50 [1.97]	30 [0.39]	
Weight	kg [lbs]	4.2 [9.26]		8.74 [19.26]		2.04 [4.50]	
Pressure Range	bar [psi]	w/Spring 2-7 Bar [30-100 psi], w/o spring 4-7 Bar [60-100 psi]					
Displacement	cm <sup>3</sup> [in <sup>3</sup> ]	220 [13.43]		494 [30.15]		494 [30.15]	
Temperature Range		Buna-N -35°~80° [-30°~180°], Viton® -30°~150° [-20°~300°]					
Actuation (open/close)	sec	0.16		0.29		0.29	

### Accessories

Sensor Accessories	Model Numbers	Part Number	Qty/Unit
M8 Inductive Sensor PNP with M8 Connector	6002P, 8002P, 11002P	OISP-011	1-4
M8 Inductive Sensor NPN with M8 Connector	6002P, 8002P, 11002P	OISN-011	1-4
M8 Inductive Sensor PNP with M12 Connector	14002P, 16502P	OISP-017	1-4
M8 Inductive Sensor NPN with M12 Connector	14002P, 16502P	OISN-017	1-4
M8 Quick Disconnect 2 Meter Cable Length*	6002P, 8002P, 11002P	CABL-010	1-4
M12 Quick Disconnect 2 Meter Cable Length*	14002P, 16502P	CABL-014	1-4
Inductive Sensor Kit (1 holder + 1 flag)	6002P, 8002P	SD60-80P	1-2
Inductive Sensor Kit (1 holder + 1 flag)	11002P	SD110P	1-2
Inductive Sensor Kit (1 holder + 1 flag)	14002P	OSMK-114	1-2
Inductive Sensor Kit (1 holder + 1 flag)	16502P	OSMK-115	1-2

\*Sensor and cable sold separately.

# DGC/GC SERIES

## 2-Jaw Precision Parallel Grippers

### How To Order

CLICK OR SCAN

To view full  
catalog pages  
on this product

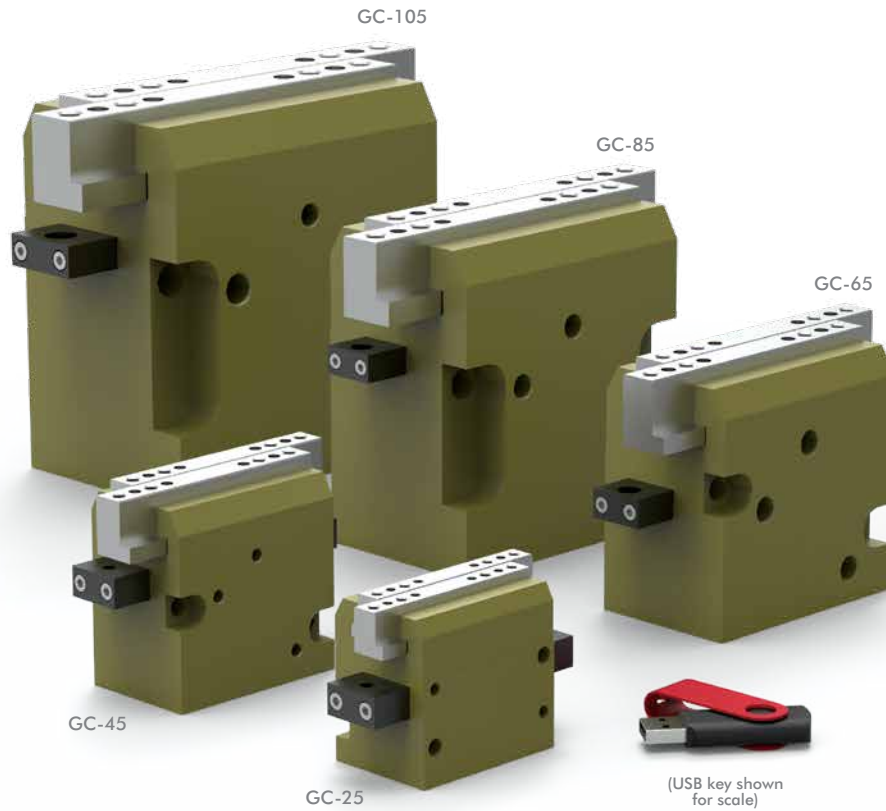

**Base Model**  
**DGC-25 GC-85**  
**DGC-45 GC-105**  
**DGC-65**

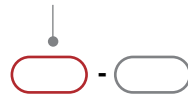

**Seals** Description  
**"Blank"** Buna-N  
**V** Viton® High Temperature

Size	Seal Repair Kits	
	Buna-N	Viton®
25	SLKT-319	SLKT-319V
45	SLKT-321	SLKT-321V
65	SLKT-323	SLKT-323V
85	SLKT-325	SLKT-325V
105	SLKT-327	SLKT-327V

**CLICK OR SCAN**

To view full catalog pages on this product

# DGC/GC SERIES

## 2-Jaw Precision Parallel Grippers

### Basic Unit Dimensions

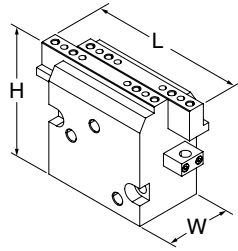

Size	L	W	H
25	75 [2.95]	38 [1.50]	55 [2.17]
45	95 [3.74]	42 [1.65]	70 [2.76]
65	125 [4.92]	53 [2.09]	90 [3.54]
85	155 [6.10]	67.5 [2.66]	120 [4.72]
105	190 [7.48]	85.5 [3.37]	145 [5.71]

### Technical Data

Specifications	Units	25	45	65	85	105
Total Rated Grip Force <b>F</b> @ 100 psi [7 bar]	N [lb]	474 [106]	481 [108]	796 [179]	1480 [333]	2318 [521]
Total Stroke	mm [in]	20 [0.787]	30 [1.181]	40 [1.575]	50 [1.968]	60 [2.362]
Weight	kg [lbs]	0.35 [0.77]	0.60 [1.32]	1.30 [2.87]	2.20 [4.85]	4.31 [9.50]
Pressure Range	bar [psi]	3-7 [45-100]				
Displacement	cm <sup>3</sup> [in <sup>3</sup> ]	16 [0.98]	29 [1.77]	62 [3.78]	136 [8.30]	261 [15.93]
Temperature Range (Buna-N seals)	°C [°F]	-35°~80° [-30°~180°]				
Temperature Range (Viton® seals)	°C [°F]	-30°~150° [-20°~300°]				
Actuation (open/close)	sec	0.20	0.25	0.35	0.50	0.70

### Accessories

Sensor Accessories	Model Numbers	Part Number	Qty/Unit
4mm NPN Inductive Sensor with Quick Disconnect*	25, 45	OHSN-014	1-2
4mm PNP Inductive Sensor with Quick Disconnect*	25, 45	OHSP-014	1-2
8mm NPN Inductive Sensor with Quick Disconnect*	65, 85	OHSN-011	1-2
8mm PNP Inductive Sensor with Quick Disconnect*	65, 85	OHSP-011	1-2
12mm NPN Inductive Sensor with Quick Disconnect*	105	OISN-017	1-2
12mm PNP Inductive Sensor with Quick Disconnect*	105	OISP-017	1-2
Quick Disconnect 2 Meter Cable Length*	24, 45, 65, 85	CABL-010	1-2
Quick Disconnect 5 Meter Cable Length*	24, 45, 65, 85	CABL-013	1-2
Quick Disconnect 2 Meter Cable Length*	105	CABL-014	1-2
Quick Disconnect 5 Meter Cable Length*	105	CABL-018	1-2

\*Sensor and cable sold separately.

# DPL SERIES

## 2-Jaw Precision Parallel Grippers

CLICK OR SCAN

To view full catalog pages on this product



### How To Order

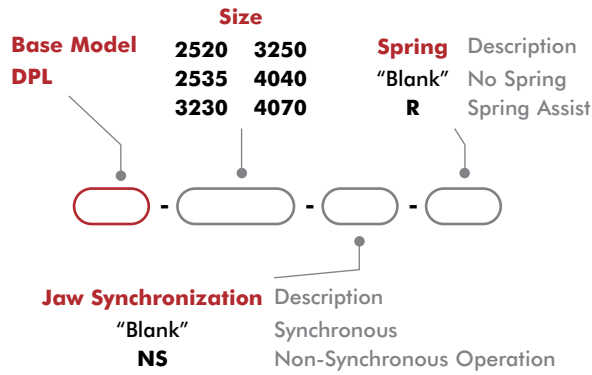
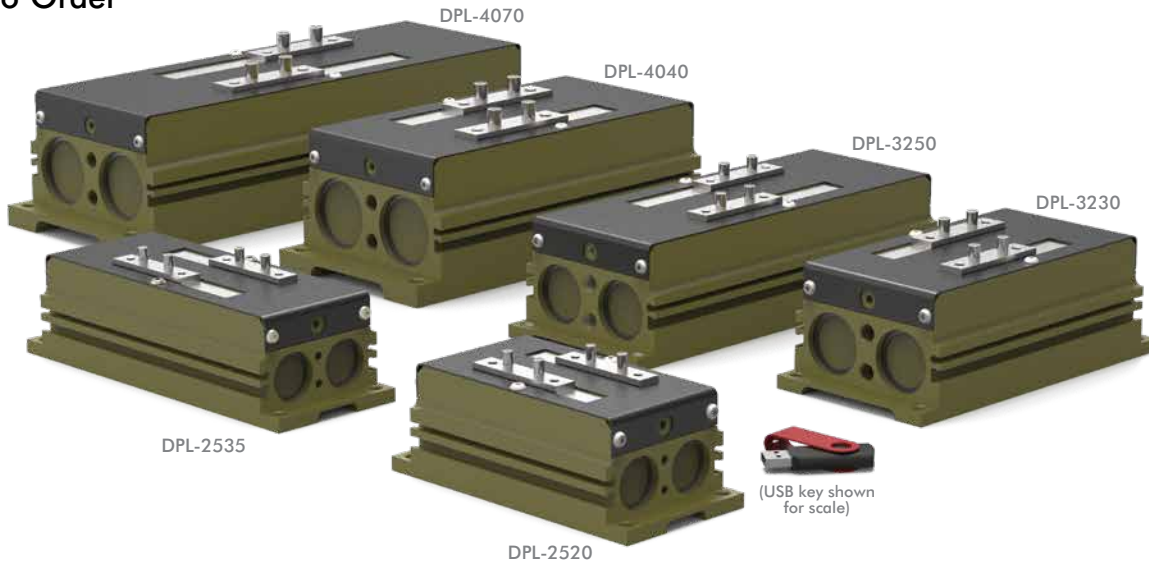

Size	Seal Repair Kit Buna-N	Rear Inlet Seal Repair Kit	In-line Jaw Mounting Kit	Inductive Sensor Mtg Kit (3 Holder/2 Flags)
2520			ODPL-001	OSMK-099
2535	SLKT-233		ODPL-002	OSMK-099
3230		SLKT-316	ODPL-003	OSMK-100
3250	SLKT-234		ODPL-004	OSMK-100
4040	SLKT-235		ODPL-005	OSMK-101
4070			ODPL-006	OSMK-101

### Basic Unit Dimensions

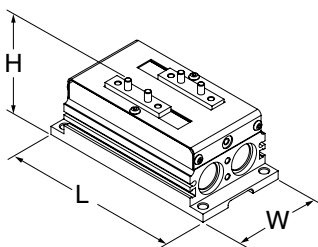

Size	L	W	H
2520	152 [5.98]		
2535	197 [7.76]	75 [2.95]	65 [2.56]
3230	186 [7.32]		
3250	246 [9.69]	93 [3.66]	74 [2.91]
4040	238 [9.37]		
4070	328 [12.91]	112 [4.41]	91 [3.58]



**CLICK OR SCAN**  
To view full  
catalog pages  
on this product

# DPL SERIES

## 2-Jaw Precision Parallel Grippers

### Technical Data

Specifications	Units	2520	2535	3230
Total Rated Grip Force <b>F</b> @ 100 psi	N [lb]	811 [182]	768 [173]	1359 [306]
Total Stroke	mm [in]	40 [1.57]	70 [2.76]	60 [2.36]
Weight	kg [lbs]	1.38 [3.04]	1.80 [3.97]	2.26 [4.98]
Pressure Range	bar [psi]	w/Spring 2-7 Bar [30-100 psi], w/o spring 4-7 Bar [60-100 psi]		
Displacement	cm <sup>3</sup> [in <sup>3</sup> ]	39 [2.38]	68 [4.15]	96 [5.86]
Temperature Range	°C [°F]	-20°~80° [-4°~180°]		
Actuation	sec	0.3	0.4	0.4

Specifications	Units	3250	4040	4070
Total Rated Grip Force <b>F</b> @ 100 psi	N [lb]	1306 [294]	2035 [457]	2029 [456]
Total Stroke	mm [in]	100 [3.94]	80 [3.15]	140 [5.51]
Weight	kg [lbs]	3.02 [6.66]	4.30 [9.48]	6.00 [13.23]
Pressure Range	bar [psi]	w/Spring 2-7 Bar [30-100 psi], w/o spring 4-7 Bar [60-100 psi]		
Displacement	cm <sup>3</sup> [in <sup>3</sup> ]	160 [9.96]	200 [12.20]	350 [21.36]
Temperature Range	°C [°F]	-20°~80° [-4°~180°]		
Actuation	sec	0.5	0.5	0.7

### Accessories

Sensor Accessories	Model Numbers	Part Number	Qty/Unit
M8 PNP Magneto Resistive Sensor with Quick Disconnect*	All Models	OHSP-017	1-3
M8 NPN Magneto Resistive Sensor with Quick Disconnect*	All Models	OHSN-017	1-3
M8 PNP Magneto Resistive Sensor (90° barrel) w/Qk. Disc.*	All Models	OHSP-011	1-3
M8 NPN Magneto Resistive Sensor (90° barrel) w/Qk. Disc.*	All Models	OHSN-011	1-3
M8 PNP Inductive Sensor with Quick Disconnect*	2520, 2535, 3230, 3250	OISP-011	1-3
M8 NPN Inductive Sensor with Quick Disconnect*	2520, 2535, 3230, 3250	OISN-011	1-3
M12 PNP Inductive Sensor with Quick Disconnect*	4040, 4070	OISP-017	1-3
M12 NPN Inductive Sensor with Quick Disconnect*	4040, 4070	OISN-017	1-3
Inductive Sensor Mounting Kit (3 Holders + 2 Flags)	See Datasheet		1
M8 Quick Disconnect 2 Meter Cable Length*	All Models	CABL-010	1-3
M8 Quick Disconnect 5 Meter Cable Length*	All Models	CABL-013	1-3
M12 Quick Disconnect 2 Meter Cable Length*	4040, 4070	CABL-014	1-3
M12 Quick Disconnect 5 Meter Cable Length*	4040, 4070	CABL-018	1-3

Pneumatic Accessories	Model Numbers	Part Number	Qty/Unit
Fitting Push-in Straight M5 - 6mm O.D. Tube	2520, 2535	PLFT-037	1-2
Fitting Push-in 90° Elbow M5 - 6mm O.D. Tube	2520, 2535	PLFT-041	1-2
Fitting Push-in Straight G1/8 - 6mm O.D. Tube	3230, 3250, 4040, 4070	PLFT-038	1-2
Fitting Push-in 90° Elbow G1/8 - 6mm O.D. Tube	3230, 3250, 4040, 4070	PLFT-042	1-2

\*Sensor and cable sold separately.

# DPP SERIES

## 2-Jaw Precision Parallel Grippers

CLICK OR SCAN

To view full catalog pages on this product



### How To Order

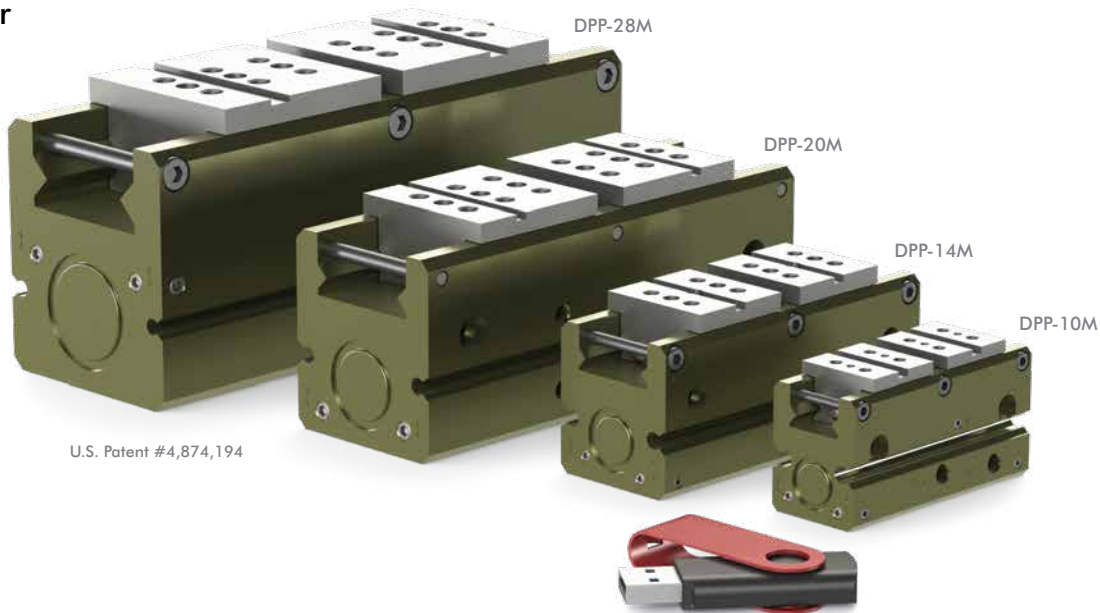

U.S. Patent #4,874,194

(USB key shown for scale)

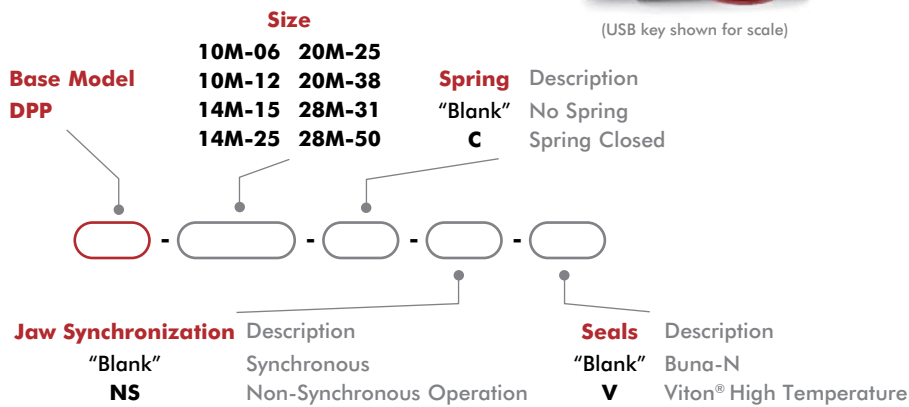

Size	Seal Repair Kits		
	Buna-N	Viton®	Manifold (Viton®)
10M	SLKT-343	SLKT-343V	SLKT-241V
14M	SLKT-344	SLKT-344V	SLKT-241V
20M	SLKT-345	SLKT-345V	SLKT-242V
28M	SLKT-346	SLKT-346V	SLKT-243V

### Basic Unit Dimensions

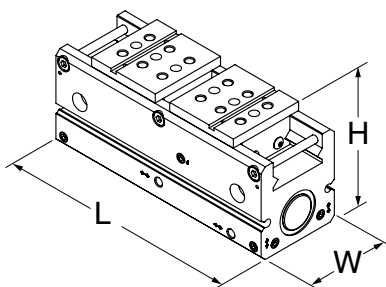

Size	L	W	H
10M-6	62.9 [2.48]	25 [0.98]	34.67 [1.36]
10M-12	73.7 [2.90]		
14M-15	90.2 [3.55]	34 [1.34]	42.21 [1.66]
14M-25	118.7 [4.67]		
20M-25	129 [5.08]	46 [1.81]	55.63 [2.19]
20M-38	175.5 [6.91]		
28M-31	162.3 [6.39]	58 [2.28]	72.54 [2.86]
28M-50	221.5 [8.72]		



**CLICK OR SCAN**  
To view full  
catalog pages  
on this product

### Technical Data

Specifications	Units	10M-6	10M-12	14M-15	14M-25
Total Rated Grip Force <b>F</b> @ 100 psi [7 bar]*	N [lb]	120 [27]		227 [51]	214 [48]
Total Stroke	mm [in]	6.4 [0.25]	12.7 [0.50]	15.9 [0.63]	25.4 [1.00]
Weight	kg [lbs]	0.16 [0.35]	0.20 [0.45]	0.48 [1.05]	0.57 [1.25]
Pressure Range (without spring)	bar [psi]	0.3-7 [5-100]			
Pressure Range (with spring)	bar [psi]	1.4-7 [20-100]		3.4-7 [50-100]	
Displacement	cm <sup>3</sup> [in <sup>3</sup> ]	0.5 [0.032]	1.1 [0.065]	2.5 [0.156]	4.1 [0.249]
Temperature Range (Buna-N seals)	°C [°F]	-35°~80° [-30°~180°]			
Temperature Range (Viton® seals)	°C [°F]	-30°~120° [-20°~250°]			
Actuation (without spring)	sec	0.10	0.11	0.15	0.19
Actuation (with spring)	sec	0.11	0.12	0.16	0.20

Specifications	Units	20M-25	20M-38	28M-31	28M-50
Total Rated Grip Force <b>F</b> @ 100 psi [7 bar]*	N [lb]	458 [103]	449 [101]	912 [205]	934 [210]
Total Stroke	mm [in]	25.4 [1.00]	38.1 [1.50]	31.8 [1.50]	50.8 [2.00]
Weight	kg [lbs]	1.02 [2.25]	1.41 [3.10]	2.06 [4.55]	2.83 [6.25]
Pressure Range (without spring)	bar [psi]	0.3-7 [5-100]			
Pressure Range (with spring)	bar [psi]	2.8-7 [40-100]	2.1-7 [30-100]	2.1-7 [30-100]	2.8-7 [40-100]
Displacement	cm <sup>3</sup> [in <sup>3</sup> ]	8.5 [0.519]	12.8 [0.779]	20.4 [1.243]	32.6 [1.998]
Temperature Range (Buna-N seals)	°C [°F]	-35°~80° [-30°~180°]			
Temperature Range (Viton® seals)	°C [°F]	-30°~120° [-20°~250°]			
Actuation (without spring)		0.20	0.24	0.19	0.23
Actuation (with spring)		0.22	0.29	0.25	0.30

\*With springs

### Accessories

Sensor Accessories	Model Numbers	Part Number	Qty/Unit
Inductive Sensor Mounting Kit (Mounts 2 sensors)	10M, 14M	OSMK-119	1-2
Inductive Sensor Mounting Kit (Mounts 2 sensors)	20M, 28M	OSMK-120	1-2
NPN Inductive Sensor (with Qk. Disc.)*	All Models	OISN-014	1-4
PNP Inductive Sensor (with Qk. Disc.)*	All Models	OISP-014	1-4
NPN Magneto Resistive Sensor (with Qk. Disc.)*†	All Models	OHSN-017	1-4
PNP Magneto Resistive Sensor (with Qk. Disc.)*†	All Models	OHSP-017	1-4
NPN Magneto Resistive Sensor 90° (with Qk. Disc.)*†	All Models	OHSN-011	1-4
PNP Magneto Resistive Sensor 90° (with Qk. Disc.)*†	All Models	OHSP-011	1-4
Quick Disconnect Cable (2 meters long)*	All Models	CABL-010	1-4
Quick Disconnect Cable (5 meters long)*	All Models	CABL-013	1-4

Pneumatic Accessories	Model Numbers	Part Number	Qty/Unit
Adjustable Flow Control-M3 Elbow-3MM OD Tube Push-in Style	10M, 14M	VLVF-018	1-2
Adjustable Flow Control-M5 Elbow-6MM OD Tube Push-in Style	20M, 28M	VLVF-008	1-2
Fail Safe Valve - M5	All Models	OFSV-004	1

\*Sensor and cable sold separately. †Piston magnet standard.



# RP-P SERIES

## 2-Jaw Precision Parallel Grippers

CLICK OR SCAN

To view full catalog pages on this product



### How To Order

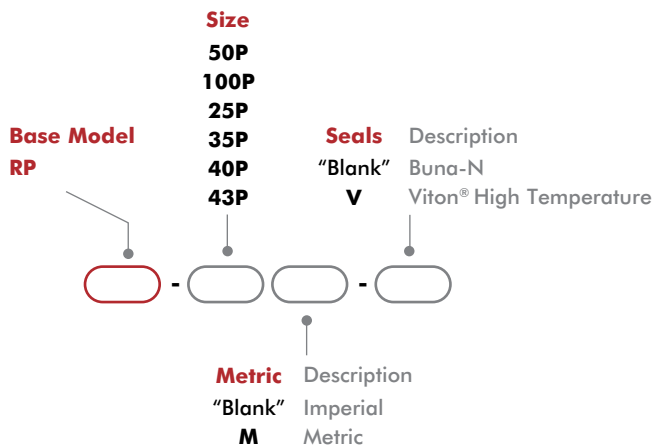

Size	Seal Repair Kits		Inductive Sensor Mtg Kit (mounts 2 sensors)
	BunaN	Viton®	
50P	SLKT353	SLKT353V	OSMK003
100P	SLKT037	SLKT037V	OSMK004
25P	SLKT046	SLKT046V	OSMK004
35P	SLKT049	SLKT049V	OSMK023
40P	SLKT050	SLKT050V	OSMK023
43P	SLKT051	SLKT051V	OSMK033

### Basic Unit Dimensions

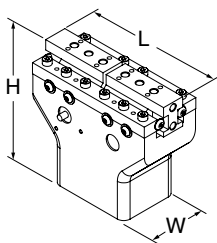

Size	L	W	H
50P	57 [2.24]	25.4 [1.00]	46.7 [1.84]
100P	83 [3.27]	59.4 [2.34]	59.4 [2.34]
25P	108 [4.25]	31.8 [1.25]	81.1 [3.19]
35P	143 [5.63]	50.8 [2.00]	103.2 [4.06]
40P	178 [7.01]	[2.25] 57.2	125 [4.92]
43P	292 [11.50]	74.7 [2.94]	175 [6.89]

**CLICK OR SCAN**To view full  
catalog pages  
on this product

# RP-P SERIES

## 2-Jaw Precision Parallel Grippers

### Technical Data

Specifications	Units	50P	100P	25P	35P	40P	43P
Total Rated Grip Force <b>F</b> @ 100 psi [7 bar]	N [lb]	107 [24]	160 [36]	356 [80]	778 [175]	890 [200]	2224 [500]
Total Stroke	mm [in]	12.7 [0.50]	25.4 [1.00]	28.7 [1.13]	25.4 [1.00]	50.8 [2.00]	76.2 [3.00]
Weight	kg [lbs]	0.14 [0.31]	0.23 [0.50]	0.45 [1.0]	1.6 [3.5]	2.7 [6.0]	7.3 [16]
Pressure Range	bar [psi]	0.3-7 [5-100]					
Displacement	cm <sup>3</sup> [in <sup>3</sup> ]	1.64 [0.100]	3.6 [0.220]	8.2 [0.500]	17.0 [1.036]	28.0 [1.710]	120.6 [7.360]
Temperature Range (Buna-N seals)	°C [°F]	-35°~80° [-30°~180°]					
Temperature Range (Viton® seals)	°C [°F]	-30°~120° [-20°~250°]					
Actuation (open/close)	sec	0.14	0.18	0.20	0.33	0.39	0.59

### Accessories

Sensor Accessories	Model Numbers	Part Number	Qty/Unit
3mm NPN Inductive Sensor with Quick Disconnect*	RP-50P	OISN-019	1-2
3mm PNP Inductive Sensor with Quick Disconnect*	RP-50P	OISP-019	1-2
3mm NPN Inductive Sensor with Quick Disconnect*	RP-100P, -25P, RP-50P, -110P, -25P	OISN-014	1-2
3mm PNP Inductive Sensor with Quick Disconnect*	RP-100P, -25P, RP-50P, -110P, -25P	OISP-014	1-2
Inductive Sensor Mounting Kit for (mounts 2 sensors)	See Datasheet		1
Quick Disconnect 2 Meter Cable Length*	All Models	CABL-010	1-2
Quick Disconnect 5 Meter Cable Length*	All Models	CABL-013	1-2

Pneumatic Accessories	Model Numbers	Part Number	Qty/Unit
Fail Safe Valve (Imperial)	RP-50P, -110P, -25P	OFSV-001	1
Fail Safe Valve (Metric)	RP-50P, -110P, -25P	OFSV-004	1
Fail Safe Valve (Imperial)	RP-35P, -40P, -43P	OFSV-002	1
Fail Safe Valve (Metric)	RP-50P, -110P, -25P	OFSV-005	1
Stroke Limited Opening Valve (LTD)	RP-35P, -40P, -43P	OLTD-001	1
Stroke Limited Opening Valve (LTD)	RP-50P, -110P, -25P	OLTD-002	1

\*Sensor and cable sold separately.

# RPL/RPLC SERIES

## 2-Jaw Precision Parallel Grippers

CLICK OR SCAN

To view full catalog pages on this product



### How To Order

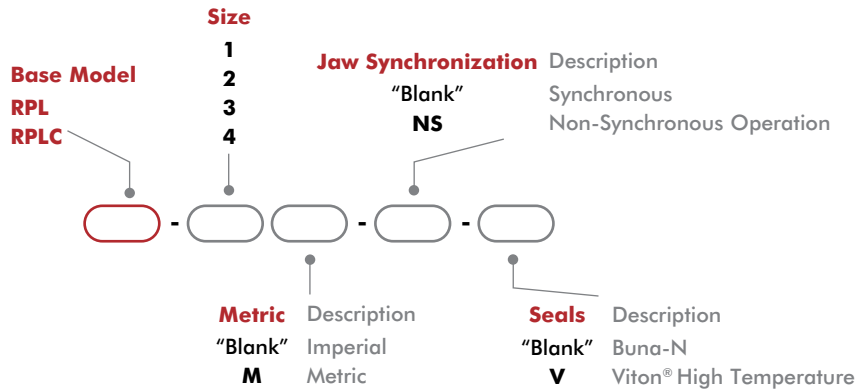

Size	Seal Repair Kits	
	Buna-N	Viton®
1	SLKT-010	SLKT-010V
2		
3	SLKT-012	SLKT-012V
4		

**CLICK OR SCAN**

To view full catalog pages on this product

# RPL/RPLC SERIES

## 2-Jaw Precision Parallel Grippers

### Basic Unit Dimensions

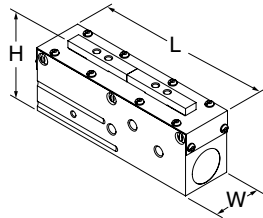

Size	L	W	H
1	44.5 [1.75]	19.1 [0.75]	29.5 [1.16]
2	59.5 [2.34]		
3	80 [3.15]	22.2 [0.87]	32.6 [1.28]
4	98.1 [3.86]		

### Technical Data

Specifications	Units	1	2	3	4
Total Rated Grip Force <b>F</b> @ 100 psi [7 bar]	N [lb]	116 [26]		160 [36]	
Total Stroke	mm [in]	6.4 [0.25]	12.7 [0.50]	19.1 [0.75]	25.4 [1.00]
Weight	kg [lbs]	0.07 [0.16]	0.09 [0.20]	0.15 [0.32]	0.17 [0.38]
Pressure Range	bar [psi]	0.3-7 [5-100]			
Displacement	cm <sup>3</sup> [in <sup>3</sup> ]	0.6 [0.038]	1.2 [0.075]	2.4 [0.147]	3.2 [0.196]
Temperature Range (Buna-N seals)	°C [°F]	-35°~80° C [-30°~180° F]			
Temperature Range (Viton® seals)	°C [°F]	-30°~120° C [-20°~250° F]			
Actuation (open/close)	sec	0.10	0.13	0.14	0.19

### Accessories

Sensor Accessories	Model Numbers	Part Number	Qty/Unit
Sensor Mounting Kit for Imperial & Metric Units (mounts 2 sensors)	All Models	OSMK-008	1
NPN Magneto Resistive Sensor with Quick Disconnect*	All Models	OHSN-017	1-2
PNP Magneto Resistive Sensor with Quick Disconnect*	All Models	OHSP-017	1-2
Quick Disconnect 2 Meter Cable Length*	All Models	CABL-010	1-2
Quick Disconnect 5 Meter Cable Length*	All Models	CABL-013	1-2

Pneumatic Accessories	Model Numbers	Part Number	Qty/Unit
Fail Safe Valve (Imperial)	All Models	OFSV-001	1
Fail Safe Valve (Metric)	All Models	OFSV-004	1

\* Sensor and cable sold separately.

# CP SERIES

## 2-Jaw General Industrial Grippers

CLICK OR SCAN

To view full catalog pages on this product



### How To Order

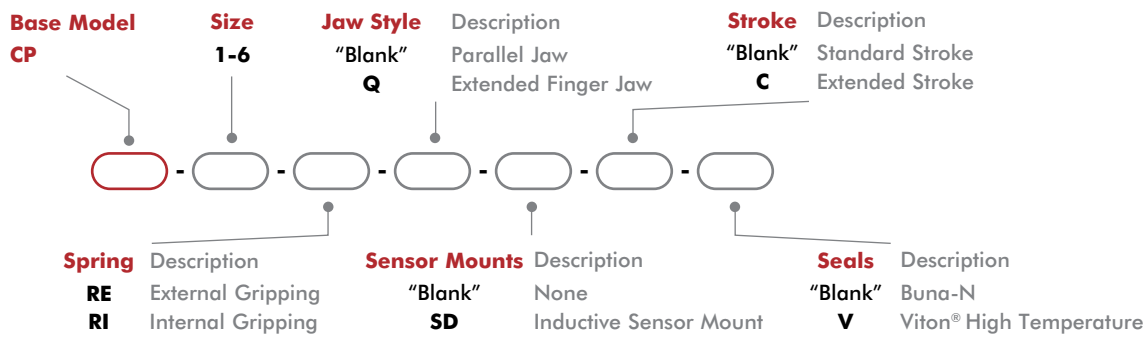
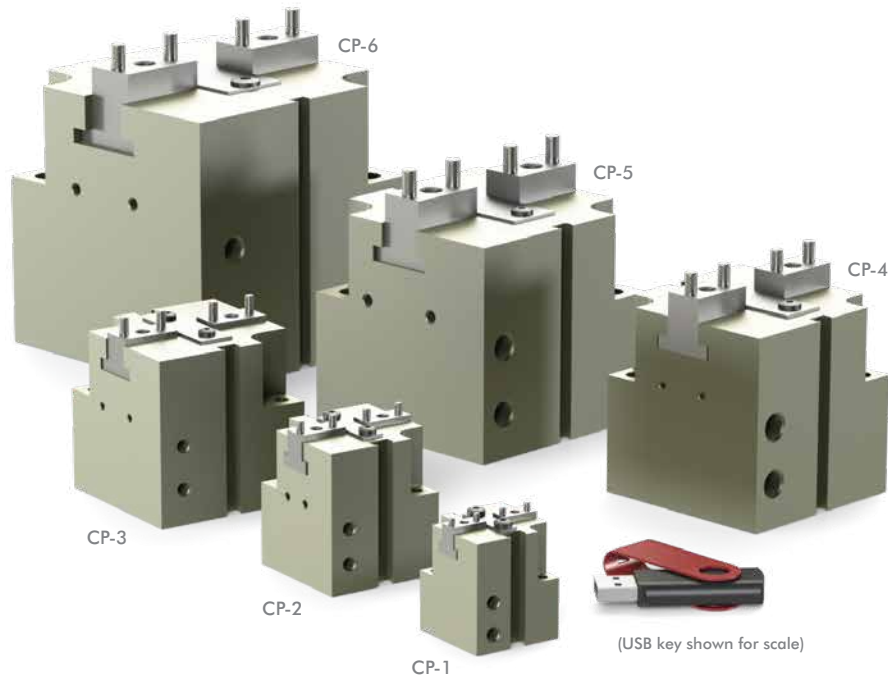

Size	Seal Repair Kits		Repair Kits (screws, springs, seals) -C		Inductive Sensor Mtg Kit (mounts 2 sensors) -SD
	Buna-N	Viton®	Buna-N	Viton®	
1	SCP1	SCP1V	KSCP1	KSCP1V	N/A
2	SCP2	SCP2V	KSCP2	KSCP2V	SDCP2
3	SCP3	SCP3V	KSCP3	KSCP3V	SDCP3
4	SCP4	SCP4V	KSCP4	KSCP4V	SDCP4
5	SCP5	SCP5V	KSCP5	KSCP5V	SDCP5
6	SCP1	SCP1V	KSCP1	KSCP1V	SDCP6

### Basic Unit Dimensions

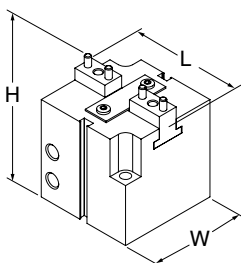

Size	L	L -C	W	H
1	37.6 [1.48]	42 [1.65]	30 [1.18]	39.2 [1.54]
2	51.4 [2.02]	58.2 [2.29]	40 [1.57]	51.5 [2.03]
3	70 [2.76]	81.2 [3.20]	55 [2.17]	67 [2.64]
4	85 [3.35]	96 [3.78]	65 [2.56]	74 [2.91]
5	102 [4.02]	120 [4.72]	80 [3.15]	91 [3.58]
6	125 [4.92]	141 [5.55]	100 [3.94]	114 [4.49]



**CLICK OR SCAN**  
To view full  
catalog pages  
on this product

### Technical Data

Specifications	Units	1	1-C	2	2-C	3	3-C
Total Rated Grip Force <b>F</b> @ 100 psi [7 bar] w/o Spring Assist	N [lbs]	89 [20]	60 [13]	238 [53]	161 [36]	677 [152]	407 [91]
Total Rated Grip Force <b>F</b> @ 100 psi [7 bar] with Spring Assist	N [lbs]	15 [3]	10 [2]	43 [10]	29 [7]	161 [36]	97 [22]
Total Stroke	mm [in]	4 [0.16]	6 [0.24]	6 [0.24]	9 [0.35]	10 [0.39]	16 [0.63]
Weight	kg [lbs]	0.09 [0.20]	0.09 [0.20]	0.21 [0.46]	0.20 [0.44]	0.45 [0.99]	0.47 [1.04]
Pressure Range w/o Spring	bar [psi]	2-10 [29-145]					
Pressure Range with Spring	bar [psi]	2.5-10 [36-145]					
Displacement	cm <sup>3</sup> [in <sup>3</sup> ]	0.7 [0.04]		2.7 [0.16]		11.7 [0.71]	
Temperature Range	°C [°F]	-35°~80° [-30°~180°]					
Actuation (open/close)	sec	0.06				0.07	

Specifications	Units	4	4-C	5	5-C	6	6-C
Total Rated Grip Force <b>F</b> @ 100 psi [7 bar] w/o Spring Assist	N [lbs]	1016 [228]	665 [149]	1591 [358]	1081 [243]	2749 [618]	2092 [470]
Total Rated Grip Force <b>F</b> @ 100 psi [7 bar] with Spring Assist	N [lbs]	222 [50]	145 [33]	322 [72]	219 [49]	711 [160]	541 [122]
Total Stroke	mm [in]	13 [0.51]	20 [0.79]	18 [0.71]	27 [1.06]	24 [0.94]	32 [1.26]
Weight	kg [lbs]	0.73 [1.61]	0.75 [1.65]	1.25 [2.76]	1.27 [2.80]	2.5 [5.51]	2.56 [5.64]
Pressure Range w/o Spring	bar [psi]	2-10 [29-145]					
Pressure Range with Spring	bar [psi]	2.5-10 [36-145]					
Displacement	cm <sup>3</sup> [in <sup>3</sup> ]	24.2 [1.48]		53.5 [3.26]		114.8 [7.01]	
Temperature Range	°C [°F]	-35°~80° [-30°~180°]					
Actuation (open/close)	sec	0.07		0.09		0.12	

### Accessories

Sensor Accessories	Model Numbers	Part Number	Qty/Unit
PNP Sensor with 0.3m Output Cable with 90° with M8 connector*	All Models	D1	1-2
NPN Sensor with 0.3m Output Cable with 90° with M8 connector*	CP-2, -3, -4, -5, -6	D10	1-2
PNP Sensor with 0.3m Output Cable with M8 connector*	All Models	D4	1-2
NPN Sensor with 0.3m Output Cable with M8 connector*	CP-2, -3, -4, -5, -6	D7	1-2
Inductive Sensor Mounting Kit (mounts 2 sensors) <b>(SD)</b>	See Datasheet		1
Inductive PNP Sensor with M8 Connector*	CP-2, -3, -4	OISP-011	1-2
Inductive NPN Sensor with M8 Connector*	CP-2, -3, -4	OISN-011	1-2
Inductive PNP Sensor with M12 Connector*	CP-5, -6	OISP-017	1-2
Inductive NPN Sensor with M12 Connector*	CP-5, -6	OISN-017	1-2
M8 Quick Disconnect 2 Meter Cable Length*	All Models	CABL-010	1-2
M12 Quick Disconnect 2 Meter Cable Length*	All Models	CABL-014	1-2

\*Sensor and cable sold separately.

# DPDL SERIES

## 2-Jaw General Industrial Grippers

CLICK OR SCAN

To view full catalog pages on this product



### How To Order

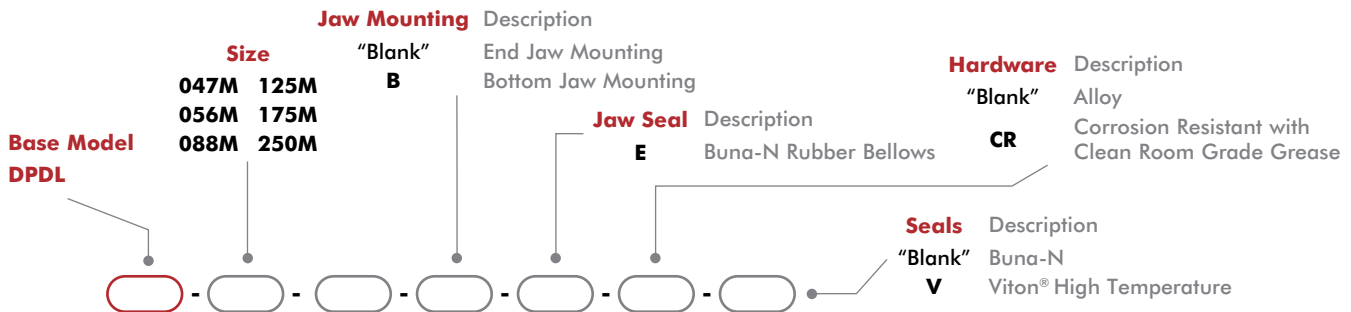
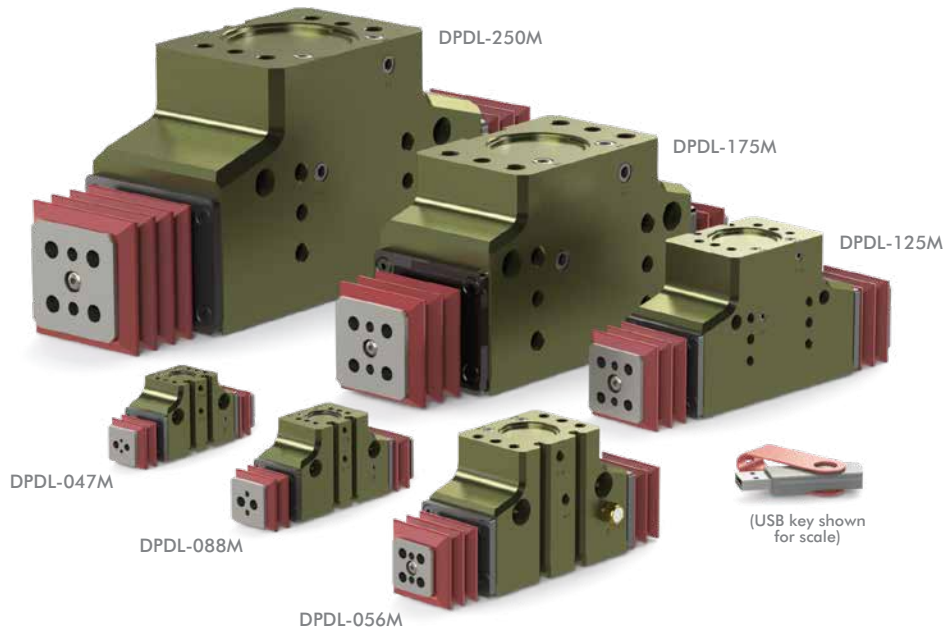

**Stroke** Stroke varies with size of gripper

047M	<b>019, 025 or 038</b>	125M	<b>050, 075 or 100</b>
056M	<b>025, 038 or 050</b>	175M	<b>075, 100 or 150</b>
088M	<b>038, 050 or 075</b>	250M	<b>100, 150 or 200</b>

Stroke dimensions

<b>019</b>	4.8mm [0.19]	<b>050</b>	12.7mm [0.50]	<b>150</b>	38.1mm [1.50]
<b>025</b>	6.4mm [0.25]	<b>075</b>	19.1mm [0.75]	<b>200</b>	50.8mm [2.00]
<b>038</b>	9.5mm [0.38]	<b>100</b>	25.4mm [1.00]		

Size	Seal Repair Kits			Sealed Jaw Boot Replacement (1 Buna-N Boot only)
	Buna-N	Viton®	Manifold (Viton®)	
047M	SLKT-185	SLKT-185V	SLKT-197V	SLKT-191
056M	SLKT-186	SLKT-186V		SLKT-192
088M	SLKT-187	SLKT-187V	SLKT-199V	SLKT-193
125M	SLKT-188	SLKT-188V		SLKT-194
175M	SLKT-189	SLKT-189V	SLKT-201V	SLKT-195
250M	SLKT-190	SLKT-190V		SLKT-196

### Basic Unit Dimensions

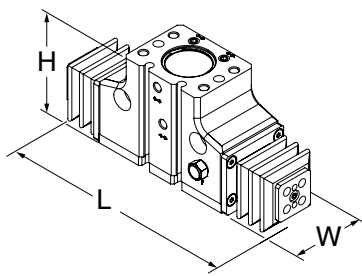

Size	L	W	H
047M	54.5 [2.16]	22.2 [.875]	32.2 [1.27]
056M	68.7 [2.70]	24.1 [.950]	37.7 [1.48]
088M	101.1 [3.98]	36.1 [1.420]	56 [2.20]
125M	128.4 [5.06]	43.2 [1.700]	68.5 [2.70]
175M	183.1 [7.21]	64.8 [2.550]	100.2 [3.94]
250M	243.8 [9.60]	79.3 [3.125]	123.3 [4.85]

**CLICK OR SCAN**

To view full catalog pages on this product

# DPDL SERIES

## 2-Jaw General Industrial Grippers

Specifications	Units	047M	056M	088M
Total Rated Grip Force <b>F</b> @ 100 psi	N [lbs]	62 [14]	98 [22]	222 [50]
Total Stroke	mm [in]	9.5 [0.38]	12.7 [0.50]	19.1 [0.75]
Weight	kg [lbs]	0.08 [0.19]	0.14 [0.32]	0.43 [0.95]
Pressure Range	bar [psi]	1.5-7 [20-100]		
Max. Vacuum for Scavenge Port	mm Hg [in. Hg]	200 [8]		
Max. Pressure for Purge Port	bar [psi]	1.4 [20]		
with <b>-E</b> Jaw Boot	bar [psi]	0.25 [4]		
Displacement	cm <sup>3</sup> [in <sup>3</sup> ]	0.6 [0.038]	1.2 [0.074]	4.4 [0.269]
Temperature Range (Buna-N seals)	°C [°F]	-35°~80° [-30°~180°]		
Temperature Range (Viton® seals)	°C [°F]	-30°~150° [-20°~300°]		
Actuation	sec	0.20	0.25	0.30

Specifications	Units	125M	175M	250M
Total Rated Grip Force <b>F</b> @ 100 psi	N [lbs]	445 [100]	890 [200]	1779 [400]
Total Stroke	mm [in]	25.4 [1.00]	38.1 [1.50]	50.8 [2.00]
Weight	kg [lbs]	0.90 [1.99]	2.73 [6.02]	5.46 [12.04]
Pressure Range	bar [psi]	1.5-7 [20-100]		
Max. Vacuum for Scavenge Port	mm Hg [in. Hg]	200 [8]		
Max. Pressure for Purge Port	bar [psi]	1.4 [20]		
with <b>-E</b> Jaw Boot	bar [psi]	0.25 [4]		
Displacement	cm <sup>3</sup> [in <sup>3</sup> ]	12.0 [0.730]	35.2 [2.150]	95.9 [5.850]
Temperature Range (Buna-N seals)	°C [°F]	-35°~80° [-30°~180°]		
Temperature Range (Viton® seals)	°C [°F]	-30°~150° [-20°~300°]		
Actuation	sec	0.50	0.70	0.90

### Accessories

Sensor Accessories	Model Numbers	Part Number	Qty/Unit
PNP Magneto Resistive Sensor with Quick Disconnect*	047M, 056M, 088M, 125M	OHSP-017	1-2
NPN Magneto Resistive Sensor with Quick Disconnect*	047M, 056M, 088M, 125M	OHSN-017	1-2
PNP Magneto Resistive Sensor with Quick Disconnect*	175M, 250M	OHSP-015	1-2
NPN Magneto Resistive Sensor with Quick Disconnect*	175M, 250M	OHSN-015	1-2
PNP Magneto Resistive Sensor (90° barrel) w/Qk. Disc.*	047M, 056M, 088M, 125M	OHSP-011	1-2
NPN Magneto Resistive Sensor (90° barrel) w/Qk. Disc.*	047M, 056M, 088M, 125M	OHSN-011	1-2
Quick Disconnect 2 Meter Cable Length*	All Models	CABL-010	1-2
Quick Disconnect 5 Meter Cable Length*	All Models	CABL-013	1-2

Pneumatic Accessories	Model Numbers	Part Number	Qty/Unit
Plumbing Fitting - M3 male to 3mm OD Tube Push-in Style	047M, 056M	PLFT-021	1-2
Plumbing Fitting - M3 male to 2mm ID Tube Barb Style	047M, 056M	PLFT-022	1-2
Plumbing Fitting - 1/8 NPT Male to 1/8 BSPP Female	125M, 250M	PLFT-028	1-2
Adjustable Flow Control G 1/8 Elbow - 6mm OD Push-in	125M, 250M	VLVF-005	1-2
Adjustable Flow Control M5 Elbow - 6mm OD Push-in	088M, 125M	VLVF-008	1-2
Fail Safe Valve M5	088M, 125M	OFSV-004	1
Fail Safe Valve G 1/8 (1/8 BSPP)	175M, 250M	OFSV-005	1

\*Sensor and cable sold separately.

Dimensions and technical information are subject to change without notice



# DPDS SERIES

## 2-Jaw General Industrial Grippers

CLICK OR SCAN

To view full catalog pages on this product



### How To Order

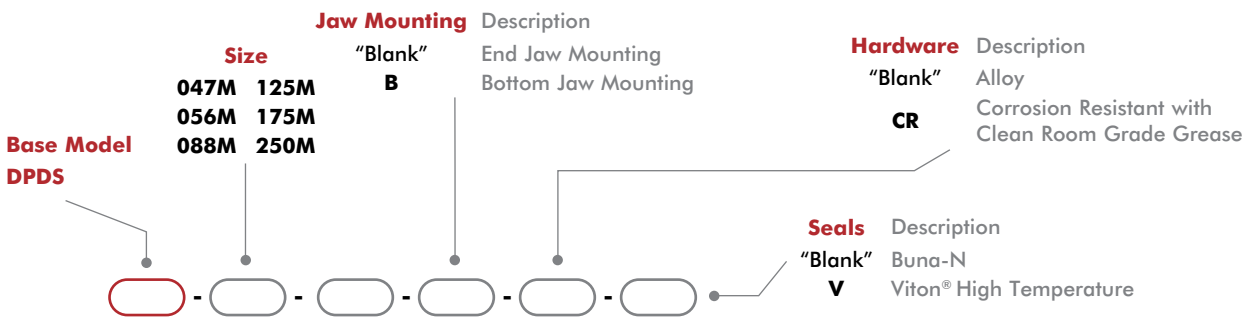
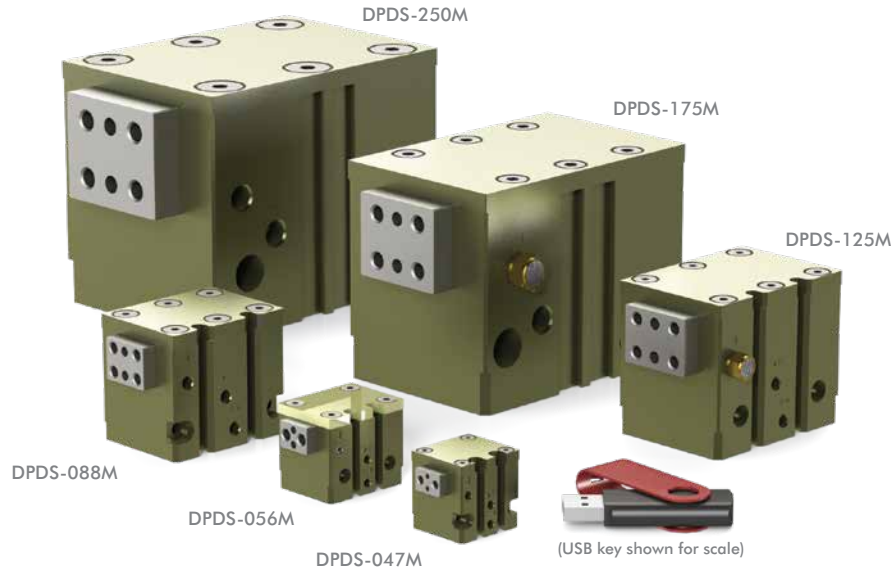

**Stroke** Stroke varies with size of gripper

047M	<b>006, 009 or 013</b>	125M	<b>019, 025 or 038</b>
056M	<b>009, 013 or 019</b>	175M	<b>025, 038 or 050</b>
088M	<b>013, 019 or 025</b>	250M	<b>038, 050 or 075</b>

Stroke dimensions

<b>006</b>	1.6mm [0.06]	<b>019</b>	4.8mm [0.19]	<b>050</b>	12.7mm [0.50]
<b>009</b>	2.4mm [0.09]	<b>025</b>	6.4mm [0.25]	<b>075</b>	19.1mm [0.75]
<b>013</b>	3.2mm [0.13]	<b>038</b>	9.5mm [0.38]		

Size	Seal Repair Kits		
	Buna-N	Viton®	Manifold (Viton®)
047M	SLKT-185	SLKT-185V	SLKT-197V
056M	SLKT-186	SLKT-186V	
088M	SLKT-187	SLKT-187V	SLKT-199V
125M	SLKT-188	SLKT-188V	
175M	SLKT-189	SLKT-189V	SLKT-201V
250M	SLKT-190	SLKT-190V	

### Basic Unit Dimensions

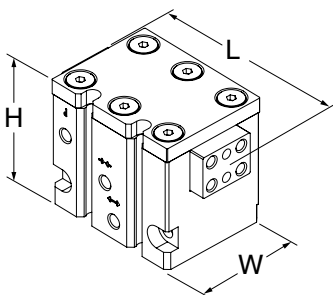

Size	L	W	H
047M	31.2 [1.23]	22.2 [0.87]	25.9 [1.02]
056M	39.8 [1.57]	24.1 [0.95]	28.9 [1.14]
088M	57.4 [2.26]	36.1 [1.42]	43.4 [1.71]
125M	73.5 [2.89]	43.2 [1.70]	52.7 [2.07]
175M	114.7 [4.52]	64.8 [2.55]	80.4 [3.17]
250M	133.1 [5.24]	79.3 [3.12]	95.5 [3.76]

**CLICK OR SCAN**

To view full catalog pages on this product

# DPDS SERIES

## 2-Jaw General Industrial Grippers

Specifications	Units	047M	056M	088M
Total Rated Grip Force <b>F</b> @ 100 psi	N [lbs]	62 [14]	98 [22]	222 [50]
Total Stroke	mm [in]	3.2 [0.13]	4.8 [0.19]	6.4 [0.25]
Weight	kg [lbs]	0.086 [0.04]	0.155 [0.07]	0.23 [0.51]
Pressure Range	bar [psi]	1.5-7 [20-100]		
Max. Vacuum for Scavenge Port	mm Hg [in. Hg]	200 [8]		
Max. Pressure for Purge Port	bar [psi]	1.4 [20]		
Displacement	cm <sup>3</sup> [in <sup>3</sup> ]	0.2 [0.013]	0.5 [0.028]	1.5 [0.090]
Temperature Range (Buna-N seals)	°C [°F]	-35°~80° [-30°~180°]		
Temperature Range (Viton® seals)	°C [°F]	-30°~150° [-20°~300°]		
Actuation	sec	0.13	0.16	0.20

Specifications	Units	125M	175M	250M
Total Rated Grip Force <b>F</b> @ 100 psi	N [lbs]	445 [100]	890 [200]	1779 [400]
Total Stroke	mm [in]	9.5 [0.38]	12.7 [0.50]	19.1 [0.75]
Weight	kg [lbs]	0.46 [1.03]	1.68 [3.70]	2.76 [6.08]
Pressure Range	bar [psi]	1.5-7 [20-100]		
Max. Vacuum for Scavenge Port	mm Hg [in. Hg]	200 [8]		
Max. Pressure for Purge Port	bar [psi]	1.4 [20]		
Displacement	cm <sup>3</sup> [in <sup>3</sup> ]	4.5 [0.274]	11.7 [0.717]	36.0 [2.194]
Temperature Range (Buna-N seals)	°C [°F]	-35°~80° [-30°~180°]		
Temperature Range (Viton® seals)	°C [°F]	-30°~150° [-20°~300°]		
Actuation	sec	0.30	0.40	0.50

### Accessories

Sensor Accessories	Model Numbers	Part Number	Qty/Unit
PNP Magneto Resistive Sensor with Quick Disconnect*	047M, 056M, 088M, 125M	OHSP-017	1-2
NPN Magneto Resistive Sensor with Quick Disconnect*	047M, 056M, 088M, 125M	OHSN-017	1-2
PNP Magneto Resistive Sensor with Quick Disconnect*	175M, 250M	OHSP-015	1-2
NPN Magneto Resistive Sensor with Quick Disconnect*	175M, 250M	OHSN-015	1-2
PNP Magneto Resistive Sensor (90° barrel) w/Qk. Disc.*	047M, 056M, 088M, 125M	OHSP-011	1-2
NPN Magneto Resistive Sensor (90° barrel) w/Qk. Disc.*	047M, 056M, 088M, 125M	OHSN-011	1-2
Quick Disconnect 2 Meter Cable Length*	All Models	CABL-010	1-2
Quick Disconnect 5 Meter Cable Length*	All Models	CABL-013	1-2

Pneumatic Accessories	Model Numbers	Part Number	Qty/Unit
Plumbing Fitting - M3 male to 3mm OD Tube Push-in Style	047M, 056M	PLFT-021	1-2
Plumbing Fitting - M3 male to 2mm ID Tube Barb Style	047M, 056M	PLFT-022	1-2
Plumbing Fitting - 1/8 NPT Male to 1/8 BSPP Female	125M, 250M	PLFT-028	1-2
Adjustable Flow Control G 1/8 Elbow - 6mm OD Push-in	125M, 250M	VLVF-005	1-2
Adjustable Flow Control M5 Elbow - 6mm OD Push-in	088M, 125M	VLVF-008	1-2
Fail Safe Valve M5	088M, 125M	OFSV-004	1
Fail Safe Valve G 1/8 (1/8 BSPP)	175M, 250M	OFSV-005	1

\* Sensor and cable sold separately.

# DPG SERIES

## 2-Jaw General Industrial Grippers

CLICK OR SCAN

To view full catalog pages on this product



### How To Order

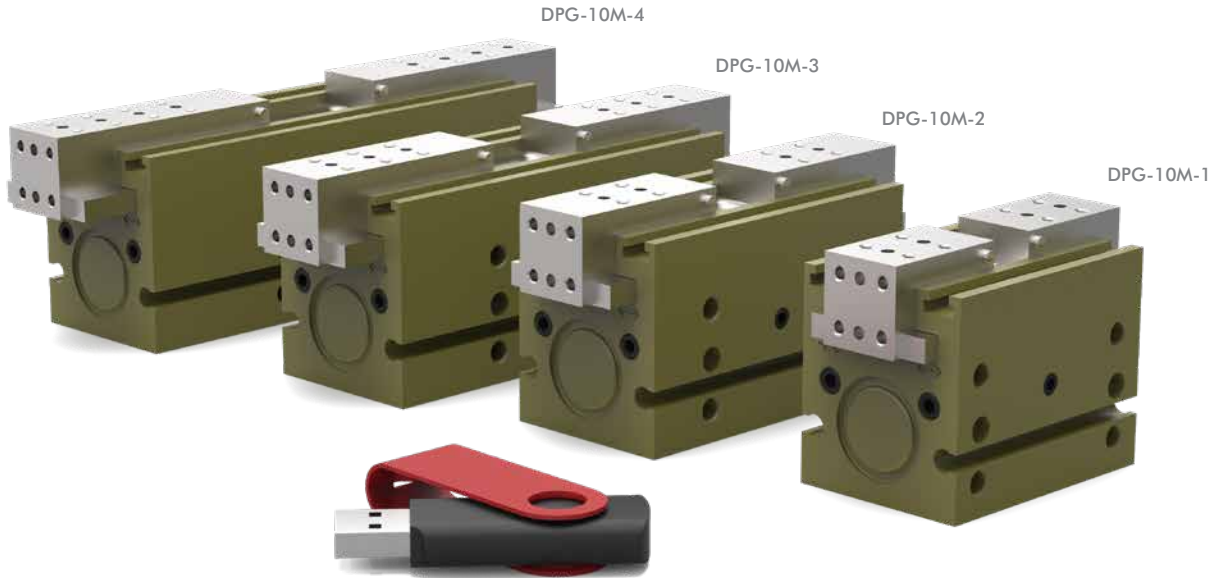

(USB key shown for scale)

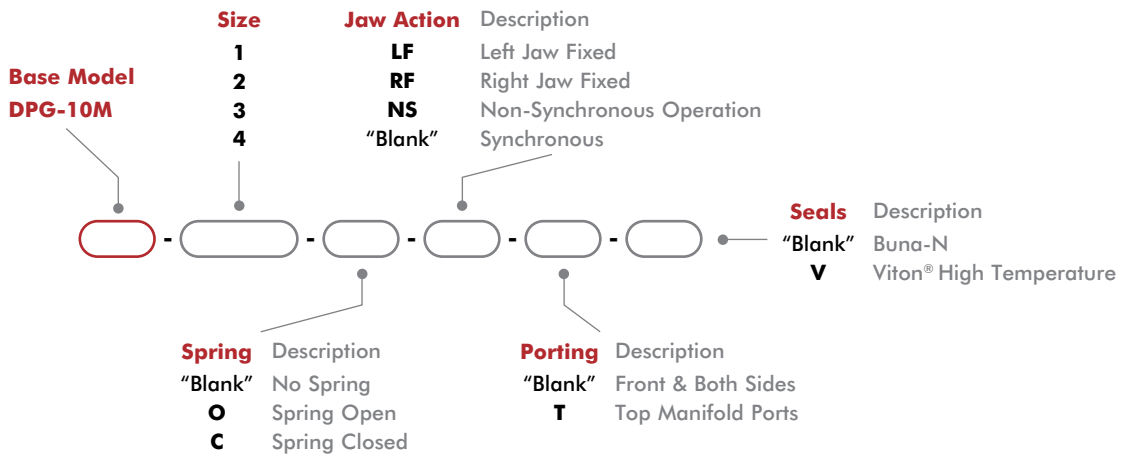

### Basic Unit Dimensions

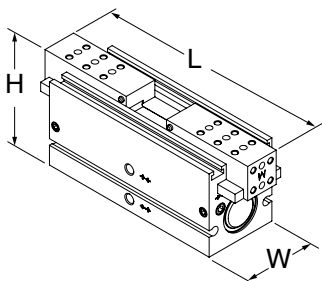

Size	L	W	H
10M-1	62 [2.44]	34.9 [1.37]	44.9 [1.77]
10M-2	86 [3.39]		
10M-3	113 [4.45]		
10M-4	137 [5.39]		



**CLICK OR SCAN**  
To view full  
catalog pages  
on this product

# DPG SERIES

## 2-Jaw General Industrial Grippers

### Technical Data

Specifications	Units	10M-1	10M-2	10M-3	10M-4
Total Rated Grip Force <b>F</b> @ 100 psi [7 bar]	N [lbs]	222 [50]			
Total Stroke	mm [in]	6.4 [0.25]	12.7 [0.50]	19.1 [0.75]	25.4 [1.00]
Weight	kg [lbs]	0.17 [0.39]	0.24 [0.53]	0.68 [0.30]	0.81 [0.36]
Pressure Range (without spring)	bar [psi]	3-7 [40-100]			
Pressure Range (with spring)	bar [psi]	1.4-7 [20-100]		3.4-7 [50-100]	
Displacement	cm <sup>3</sup> [in <sup>3</sup> ]	1.2 [0.076]	2.5 [0.153]	3.8 [0.230]	5.0 [0.306]
Temperature Range (Buna-N seals)	°C [°F]	-35°~80° [-30°~180°]			
Temperature Range (Viton® seals)	°C [°F]	-30°~150° [-20°~300°]			
Actuation	sec	0.13	0.19	0.29	0.40

### Accessories

Sensor Accessories	Model Numbers	Part Number	Qty/Unit
Inductive Sensor Mounting Kit (Mounts 2 Sensors)	All Models	OSMK-097	1-2
NPN Inductive Sensor with Qk. Disconnect*	All Models	OISN-019	1-4
PNP Inductive Sensor with Qk. Disconnect*	All Models	OISP-019	1-4
NPN Magneto Resistive Sensor w/Qk. Disconnect*	All Models	OHSN-017	1-4
PNP Magneto Resistive Sensor w/Qk. Disconnect*	All Models	OHSP-017	1-4
NPN Magneto Resistive Sensor (90°) w/Qk. Disconnect*	All Models	OHSN-011	1-4
PNP Magneto Resistive Sensor (90°) w/Qk. Disconnect*	All Models	OHSP-011	1-4
Quick Disconnect Cable (2 meters long)*	All Models	CABL-010	1-4
Quick Disconnect Cable (5 meters long)*	All Models	CABL-013	1-4
Quick Disconnect Cable Extension Cord (1 meter long)*	All Models	CABL-015	1-4
Quick Disconnect Cable Extension Cord (2 meters long)*	All Models	CABL-016	1-4
Pneumatic Accessories	Model Numbers	Part Number	Qty/Unit
Buna-N Seal Repair Kit	All Models	SLKT-183	1
Viton® Seal Repair Kit	All Models	SLKT-183V	1
-T Plumbing Fitting - M3 male to 3mm OD Tube Push-in Style	All Models	PLFT-021	1-2
-T Plumbing Fitting - M3 male to 2mm ID Tube Barb Style	All Models	PLFT-022	1-2
Fail Safe Valve - M5 (Metric)	All Models	OFSV-004	1
Adjustable Flow Control (Metric)	All Models	VLVF-008	1-2
Top Port Manifold Seal Kit	All Models	SLKT-184V	1

\*Sensor and cable sold separately.

# RDH SERIES

## 2-Jaw General Industrial Grippers

CLICK OR SCAN

To view full catalog pages on this product



### How To Order

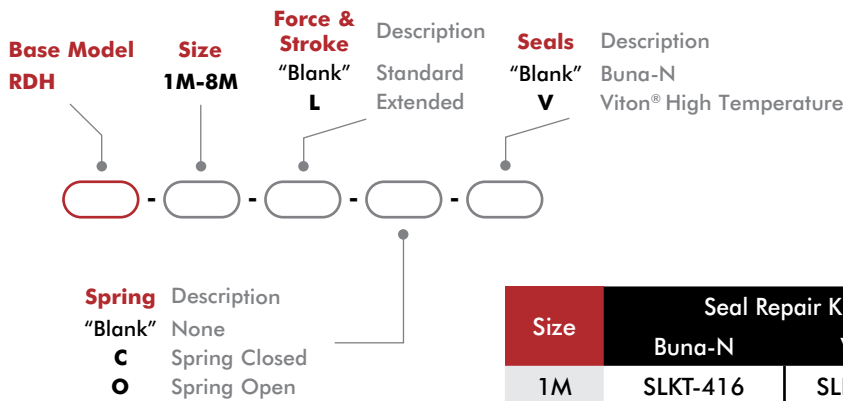
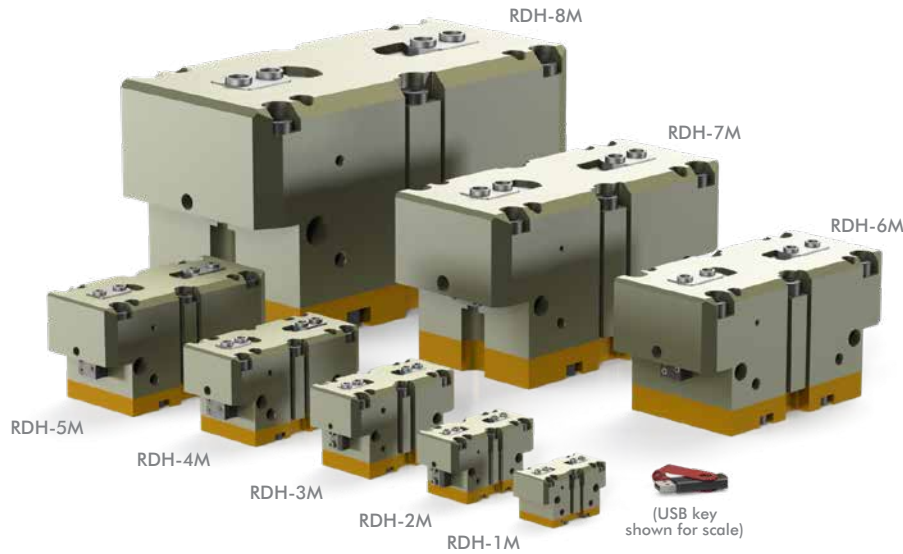

Size	Seal Repair Kits		Rear Inlet Seal Repair Kit	
	Buna-N	Viton®	Buna-N	Viton®
1M	SLKT-416	SLKT-416V	SLKT-363	SLKT-363V
2M	SLKT-417	SLKT-417V	SLKT-364	SLKT-364V
3M	SLKT-418	SLKT-418V	SLKT-365	SLKT-365V
4M	SLKT-419	SLKT-419V	SLKT-366	SLKT-366V
5M	SLKT-420	SLKT-420V		
6M	SLKT-421	SLKT-421V		
7M	SLKT-422	SLKT-422V		
8M	SLKT-423	SLKT-423V		

### Basic Unit Dimensions

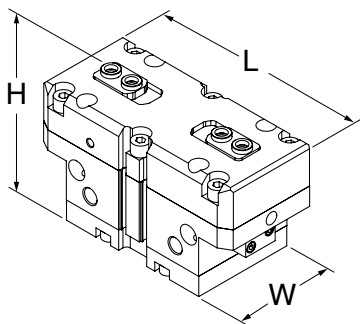

Size	L	W	H
1M	63 [2.48]	33 [1.30]	38.5 [1.52]
2M	83 [3.27]	40 [1.57]	58 [2.28]
3M	104 [4.09]	50 [1.97]	66 [2.60]
4M	129 [5.08]	60 [2.36]	74.5 [2.93]
5M	162 [6.38]	76 [2.99]	90.5 [3.56]
6M	205 [8.07]	100 [3.94]	113 [4.45]
7M	258 [10.16]	120 [4.72]	147 [5.79]
8M	355 [13.98]	180 [7.09]	201 [7.91]

**CLICK OR SCAN**

To view full catalog pages on this product

# RDH SERIES

## 2-Jaw General Industrial Grippers

Specifications	Units	1M	1M-L	2M	2M-L	3M	3M-L	4M	4M-L
Total Rated Grip Force <b>F</b> @ 100 psi [7 bar] w/o Spring Assist	N [lbs]	555 [125]	361 [81]	754 [170]	494 [111]	1317 [296]	854 [192]	2177 [490]	1414 [318]
Total Rated Grip Force <b>F</b> @ 100 psi [7 bar] with Spring Assist	N [lbs]	693 [156]	452 [102]	1006 [226]	661 [149]	1683 [379]	1094 [246]	2789 [628]	1814 [408]
Total Stroke	mm [in]	4 [0.16]	8 [0.32]	6 [0.24]	12 [0.47]	8 [0.31]	16 [0.63]	10 [0.39]	20 [0.79]
Weight	kg [lbs]	0.19 [0.4]	0.21 [0.5]	0.39 [0.86]	0.42 [0.93]	0.82 [1.81]	0.88 [1.94]	1.43 [3.15]	1.51 [3.33]
Pressure Range	bar [psi]	w/spring 2-7 [30-100], w/o spring 3.5-7 [50-100]							
Max. Vacuum for Scavenge Port	mm Hg [in Hg]	200 [8]							
Max. Pressure for Purge Port	bar [psi]	2.1 [30]							
Displacement	cm <sup>3</sup> [in <sup>3</sup> ]	5 [0.31]		10.3 [0.63]		23.4 [1.43]		47.5 [2.90]	
Temperature Range (Buna-N seals)	°C [°F]	-35°~80° [-30°~180°]							
Temperature Range (Viton® seals)	°C [°F]	-30°~150° [-20°~300°]							
Actuation (open/close)	sec.	0.06		0.07		0.08			

Specifications (cont.)	Units	5M	5M-L	6M	6M-L	7M	7M-L	8M	8M-L
Total Rated Grip Force <b>F</b> @ 100 psi [7 bar] w/o Spring Assist	N [lbs]	3593 [808]	2333 [525]	6250 [1406]	4062 [914]	9901 [2228]	6404 [1441]	21958 [4941]	14178 [3190]
Total Rated Grip Force <b>F</b> @ 100 psi [7 bar] with Spring Assist	N [lbs]	4609 [1037]	2999 [675]	8640 [1944]	5623 [1265]	12542 [2822]	8135 [1830]	28002 [6300]	18115 [4076]
Total Stroke	mm [in]	13 [0.51]	26 [1.02]	16 [0.63]	32 [1.26]	25 [0.98]	50 [1.97]	35 [1.38]	70 [2.76]
Weight	kg [lbs]	2.75 [6.06]	2.98 [6.57]	5.77 [12.72]		11.25 [24.8]		32.3 [71.1]	
Pressure Range	bar [psi]	w/spring 2-7 [30-100], w/o spring 3.5-7 [50-100]							
Max. Vacuum for Scavenge Port	mm Hg [in Hg]	20 [8]							
Max. Pressure for Purge Port	bar [psi]	2.1 [30]							
Displacement	cm <sup>3</sup> [in <sup>3</sup> ]	102 [6.22]		216 [13.18]		540 [32.95]		1689 [103.1]	
Temperature Range (Buna-N seals)	°C [°F]	-35°~80° [-30°~180°]							
Temperature Range (Viton® seals)	°C [°F]	-30°~150° [-20°~300°]							
Actuation (open/close)	sec.	0.14		0.20		0.55		1.3	

### Accessories

Sensor Accessories	Model Numbers	Part Number	Qty/Unit
8mm PNP Magneto Resistive Sensor (90° barrel) w/ M8 Qk. Disc*	All Models	OHSP-011	1-4
8mm NPN Magneto Resistive Sensor (90° barrel) w/ M8 Qk. Disc*	All Models	OHSN-011	1-4
8mm PNP Magneto Resistive Sensor Short Barrel w/ M8 Qk Disc*	All Models	OHSP-017	1-4
8mm NPN Magneto Resistive Sensor Short Barrel w/ M8 Qk Disc*	All Models	OHSN-017	1-4
8mm PNP Inductive Sensor w/ M12 Quick Disconnect*	RDH-4M, -5M, -6M	OISP-011	1-2
8mm NPN Inductive Sensor w/ M12 Quick Disconnect*	RDH-4M, -5M, -6M	OISN-011	1-2
12mm PNP Inductive Sensor w/ M12 Quick Disconnect*	RDH-7M, -8M	OISP-017	1-2
12mm NPN Inductive Sensor w/ M12 Quick Disconnect*	RDH-7M, -8M	OISN-017	1-2
M8 Quick Disconnect 2 Meter Cable Length*	All Models	CABL-010	1-4
M8 Quick Disconnect 5 Meter Cable Length*	All Models	CABL-013	1-4
M12 Quick Disconnect 2 Meter Cable Length*	RDH-7M, -8M	CABL-014	1-2
M12 Quick Disconnect 5 Meter Cable Length*	RDH-7M, -8M	CABL-018	1-2

Pneumatic Accessories	Model Numbers	Part Number	Qty/Unit
M5 Adjustable Flow Control	RDH-1M, -2M, -3M	VLVF-008	1-2
G 1/4" Adjustable Flow Control	RDH-4M, -5M, -6M, -7M	VLVF-005	1-2
G 1/8" Adjustable Flow Control	RDH-8M	VLVF-010	1-2

\* Sensor and cable sold separately.

Dimensions and technical information are subject to change without notice

# REP2 SERIES

## 2-Jaw General Industrial Grippers

### How To Order

CLICK OR SCAN

To view full catalog pages on this product

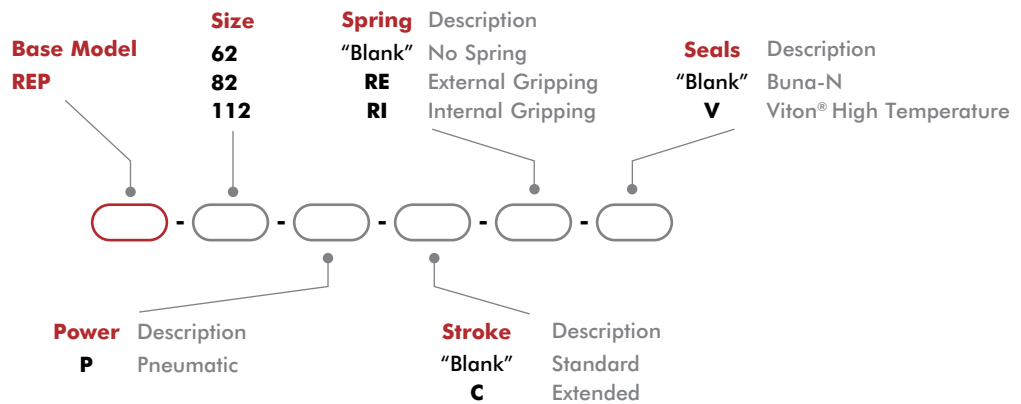

Size	Seal Repair Kits	
	Buna-N	Viton®
62P	SLKT-155	SLKT-155V
82P	SLKT-157	SLKT-157V
112P	SLKT-158	SLKT-158V

**CLICK OR SCAN**

To view full catalog pages on this product

# REP2 SERIES

## 2-Jaw General Industrial Grippers

### Basic Unit Dimensions

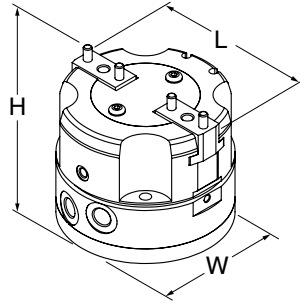

Size	L	W	H
62P	70	60 [2.36]	72 [2.83]
62P-C	82		
82P	94	80 [3.15]	74 [2.91]
82P-C	108		
112P	138	110 [4.33]	98 [3.86]
112P-C	158		

### Technical Data

Specifications	Units	62	62-C	82	82-C	112	112-C
Total Rated Grip Force <b>F</b> @ 100 psi [7 bar]*	N [lbs]	771 [173]	480 [108]	2140 [481]	1382 [311]	3351 [753]	2233 [502]
Total Stroke	mm [in]	10 [0.394]	16 [0.630]	13 [0.512]	20 [0.787]	20 [0.787]	30 [1.181]
Weight	kg [lbs]	0.55 [1.2]		0.9 [2.0]		2.45 [5.4]	
Pressure Range w/o Spring	bar [psi]	2-7 [30-100]					
Pressure Range with Spring	bar [psi]	3-7 [45-100]		4-7 [60-100]			
Displacement	cm <sup>3</sup> [in <sup>3</sup> ]	12 [0.72]		35 [2.13]		87 [5.31]	
Temperature Range (Buna-N seals)	°C [°F]	-35°~80° [-30°~180°]					
Temperature Range (Viton® seals)	°C [°F]	-30°~150° [-20°~300°]					
Actuation (open/close)	sec	0.10		0.18		0.35	
Accuracy	mm [in]	±0.05 [±0.002]					

\* with springs

### Accessories

Sensor Accessories	Model Numbers	Part Number	Qty/Unit
NPN Inductive Sensor with M8 Quick Disconnect*	All Models	OISN-011	1-4
PNP Inductive Sensor with M8 Quick Disconnect*	All Models	OISP-011	1-4
NPN Magneto Resistive Sensor with Quick Disconnect*†	All Models	OHSN-006	1-2
PNP Magneto Resistive Sensor with Quick Disconnect*†	All Models	OHSP-006	1-2
NPN Magneto Resistive Sensor (Short Barrel) with Qk Disconnect*†	All Models	OHSN-008	1-2
PNP Magneto Resistive Sensor (Short Barrel) with Qk Disconnect*†	All Models	OHSP-008	1-2
M8 Quick Disconnect 2 Meter Cable Length*	All Models	CABL-010	1-4
M8 Quick Disconnect 2 Meter Cable Length*	All Models	CABL-013	1-4
Inductive Sensor Mounting Kit (Mounts 2 Sensors)	62	OSMK-102	1-2
Inductive Sensor Mounting Kit (Mounts 2 Sensors)	82	OSMK-103	1-2
Inductive Sensor Mounting Kit (Mounts 2 Sensors)	112	OSMK-104	1-2

\* Sensor and cable sold separately. †The gripper comes with adjustable slots for two magnetic sensors (to control jaw position). Must be used with the **-RE** or **-RI** option.



# RP5-10 SERIES

## 2-Jaw General Industrial Grippers

### How To Order

CLICK OR SCAN

To view full  
catalog pages  
on this product

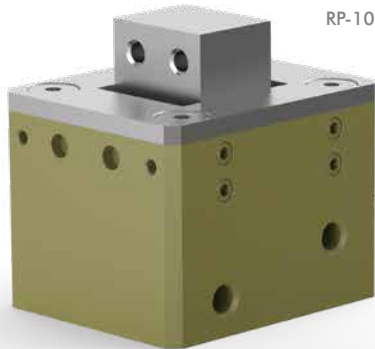

RP-10



RP-5, 5-FS

U.S. Patent #5,125,708



(USB key shown for scale)

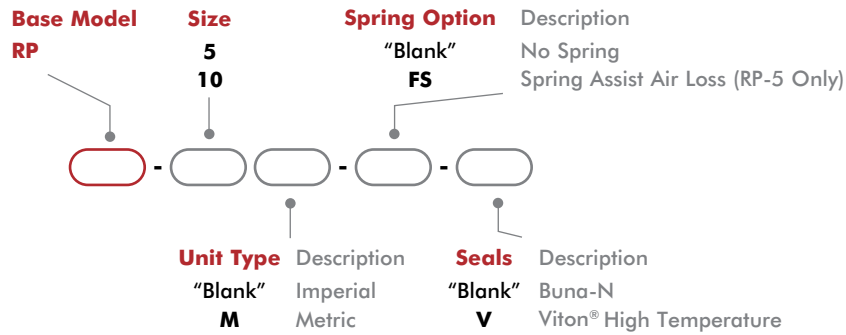

Size	Seal Repair Kits	
	Buna-N	Viton®
5	SLKT-052	SLKT-052V
10	SLKT-036	SLKT-036V



**CLICK OR SCAN**  
To view full  
catalog pages  
on this product

# RP5-10 SERIES

## 2-Jaw General Industrial Grippers

### Basic Unit Dimensions

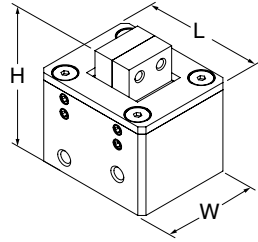

Size	L	W	H
5	29 [1.14]	25.4 [1.00]	36.5 [1.44]
5-FS			
10	38.1 [1.50]	31.7 [1.25]	37.3 [1.47]

### Technical Data

Specifications	Units	5	5-FS	10
Total Rated Grip Force <b>F</b> @ 100 psi [7 bar]	N [lbs]	156 [35]	178 [40]	
Total Stroke	mm [in]	4.1 [0.16]		6.4 [0.25]
Weight	kg [lbs]	0.08 [0.18]		0.13 [0.28]
Pressure Range	bar [psi]	3-7 [40-100]		
Ingress Protection Class (IP)		IP43		
Displacement	cm <sup>3</sup> [in <sup>3</sup> ]	0.7 [0.042]		1.6 [0.098]
Temperature Range (Buna-N seals)	°C [°F]	-35°~80° [-30°~180°]		
Temperature Range (Viton® seals)	°C [°F]	-30°~150° [-20°~300°]		
Actuation	sec	0.14		0.13
Accuracy	mm [in]	±0.03 [±0.001]		
Repeatability	mm [in]	±0.01 [±0.0005]		
Valve to Actuate		4-way, 2-position		

### Accessories

Sensor Accessories	Model Numbers	Part Number	Qty/Unit
Sensor Mounting Kit for Imperial & Metric Units (mounts 2 sensors)	RP-5	OSMK-001	1
Sensor Mounting Kit for Imperial & Metric Units (mounts 2 sensors)	RP-10	OSMK-002	1
NPN Inductive Sensor with Quick Disconnect*	All Models	OISN-019	1-2
PNP Inductive Sensor with Quick Disconnect*	All Models	OISP-019	1-2
Quick Disconnect 2 Meter Cable Length*	All Models	CABL-010	1-2
Quick Disconnect 5 Meter Cable Length*	All Models	CABL-013	1-2
Pneumatic Accessories	Model Numbers	Part Number	Qty/Unit
Fail Safe Valve (Imperial)	All Models	OFSV-001	1
Fail Safe Valve (Metric)	All Models	OFSV-004	1

\* Sensor and cable sold separately.

# RP SERIES

## 2-Jaw General Industrial Grippers

CLICK OR SCAN

To view full catalog pages on this product



### How To Order

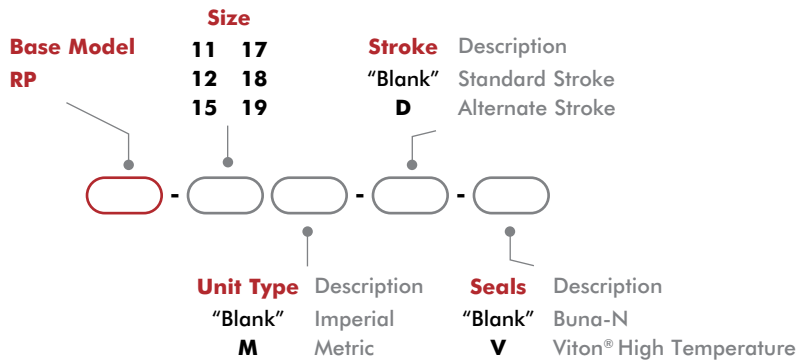
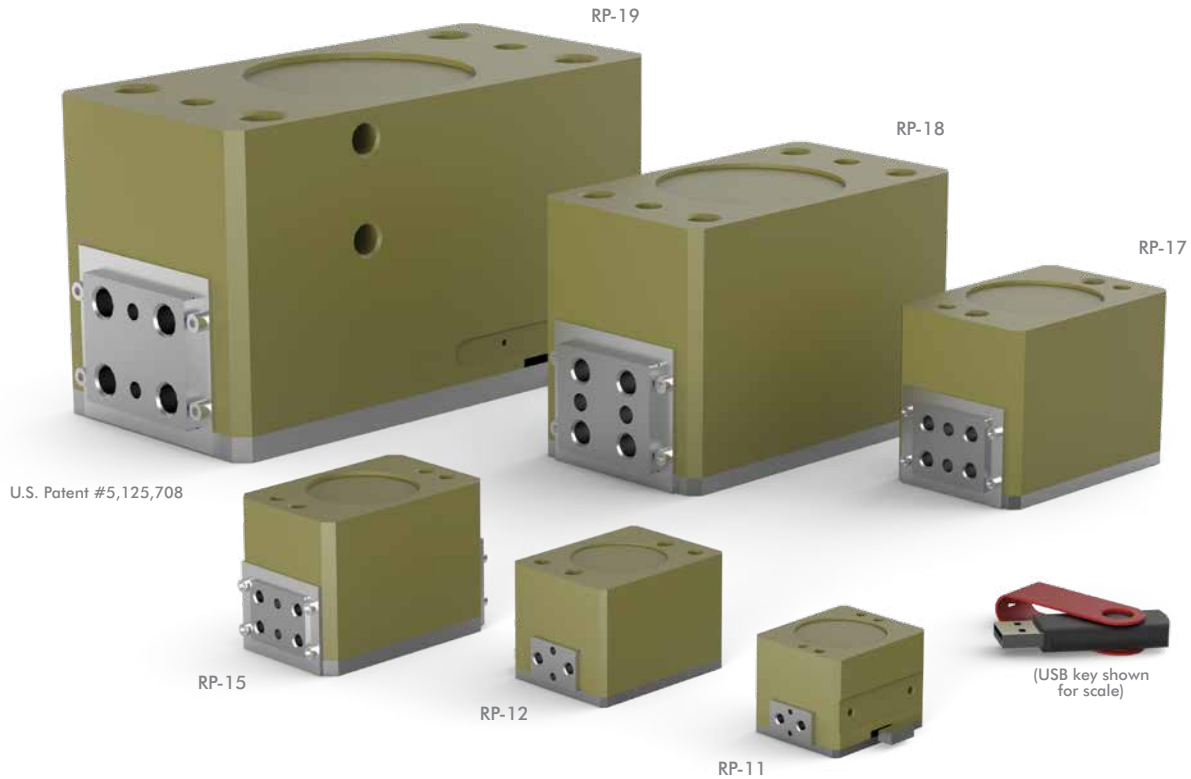

Size	Seal Repair Kits		Fail Safe Valve		Inductive Sensor Mtg Kit (mounts 2 sensors)
	Buna-N	Viton®	Imperial	Metric	
11	SLKT-036	SLKT-036V			
12	SLKT-040	SLKT-040V	OFSV-001	OFSV-004	OSMK-003
15	SLKT-041	SLKT-041V			
17	SLKT-042	SLKT-042V			
18	SLKT-043	SLKT-043V	OFSV-002	OFSV-005	OSMK-072
19	SLKT-044	SLKT-044V	OFSV-003	OFSV-006	OSMK-073



**CLICK OR SCAN**  
To view full  
catalog pages  
on this product

### Basic Unit Dimensions

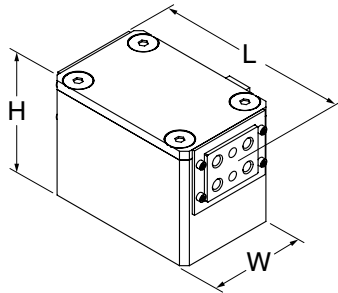

Size	L	L -D	W	H
11	48 [1.89]	45 [1.77]	31.8 [1.25]	28.6 [1.13]
12	63 [2.48]	60 [2.36]		35.6 [1.40]
15	81 [3.19]	76 [2.99]	41.3 [1.63]	47.3 [1.86]
17	108 [4.25]	117 [4.61]	54 [2.13]	61.9 [2.44]
18	177 [6.97]	190 [7.48]	74.9 [2.95]	92.8 [3.65]
19	266 [10.47]	254 [10.00]	100.3 [3.95]	118.7 [4.67]

### Technical Data

Specifications	Units	11	11-D	12	12-D	15	15-D
Total Rated Grip Force <b>F</b> @ 100 psi [7 bar]	N [lbs]	178 [40]	312 [70]	178 [40]	267 [60]	310 [70]	445 [100]
Total Stroke	mm [in]	6.4 [0.25]	4 [0.16]	9.5 [0.38]	6 [0.24]	12.7 [0.50]	8 [0.31]
Weight	kg [lbs]	0.12 [0.26]		0.25 [0.56]		0.57 [1.25]	
Pressure Range	bar [psi]	3-7 [40-100]					
Displacement	cm <sup>3</sup> [in <sup>3</sup> ]	1.6 [0.098]		2.5 [0.150]		4.9 [0.300]	
Temperature Range (Buna-N seals)	°C [°F]	-35°~80° [-30°~180°]					
Temperature Range (Viton® seals)	°C [°F]	-30°~150° [-20°~300°]					
Actuation	sec	0.13				0.20	

Specifications	Units	17	17-D	18	18-D	19	19-D
Total Rated Grip Force <b>F</b> @ 100 psi [7 bar]	N [lbs]	979 [220]	578 [130]	1779 [400]	1112 [250]	2669 [600]	3336 [750]
Total Stroke	mm [in]	19.1 [0.75]	28 [1.10]	31.8 [1.25]	43 [1.70]	50.8 [2.00]	38.1 [1.50]
Weight	kg [lbs]	1.0 [2.2]		3.5 [7.7]		9.5 [21]	
Pressure Range	bar [psi]	3-7 [40-100]					
Displacement	cm <sup>3</sup> [in <sup>3</sup> ]	22.9 [1.400]		72.1 [4.400]		157.3 [9.600]	
Temperature Range (Buna-N seals)	°C [°F]	-35°~80° [-30°~180°]					
Temperature Range (Viton® seals)	°C [°F]	-30°~150° [-20°~300°]					
Actuation	sec	0.18		0.22		0.50	

### Accessories

Sensor Accessories	Model Numbers	Part Number	Qty/Unit
Sensor Mounting Kit for Imperial & Metric Units (mounts 2 sensors)	See Datasheet		1
NPN Inductive Sensor with Quick Disconnect*	11, 12, 15	OISN-019	1-2
PNP Inductive Sensor with Quick Disconnect*	11, 12, 15	OISP-019	1-2
NPN Inductive Sensor with Quick Disconnect*	17, 18, 19	OISN-011	1-2
PNP Inductive Sensor with Quick Disconnect*	17, 18, 19	OISP-011	1-2
Quick Disconnect 2 Meter Cable Length*	All Models	CABL-010	1-2
Quick Disconnect 5 Meter Cable Length*	All Models	CABL-013	1-2

Pneumatic Accessories	Model Numbers	Part Number	Qty/Unit
Fail Safe Valve (Imperial)	See Datasheet		1
Fail Safe Valve (Metric)	See Datasheet		1

\*Sensor and cable sold separately.

# RPM/RPMC SERIES

## 2-Jaw General Industrial Grippers

### How To Order

CLICK OR SCAN

To view full  
catalog pages  
on this product

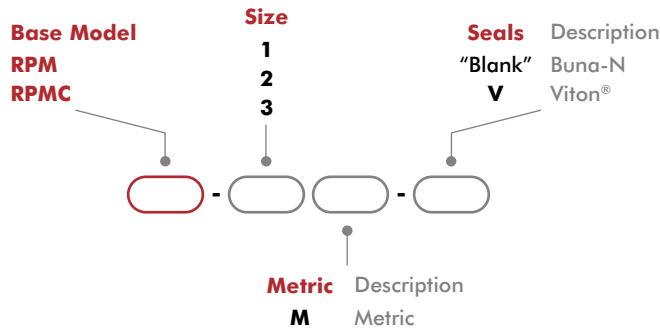

### Basic Unit Dimensions

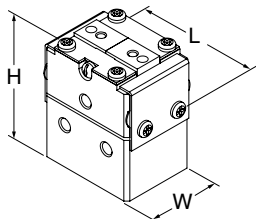

Size	L	W	H
1	23 [0.91]	16 [0.63]	24 [0.94]
2	24 [0.94]		25.5 [1.00]
3	30 [1.18]		

**CLICK OR SCAN**To view full  
catalog pages  
on this product

# RPM/RPMC SERIES

## 2-Jaw General Industrial Grippers

### Technical Data

Specifications	Units	1	2	3
Total Rated Grip Force <b>F</b> @ 100 psi [7 bar]	N [lbs]	36 [8]		
Total Stroke	mm [in]	3.2 [0.13]	4.8 [0.19]	6.3 [0.25]
Weight	kg [lbs]	0.024 [0.052]	0.026 [0.058]	0.034 [0.074]
Pressure Range	bar [psi]	3-7 [40-100]		
Displacement	cm <sup>3</sup> [in <sup>3</sup> ]	0.13 [0.008]	0.20 [0.012]	0.25 [0.015]
Temperature Range (Buna-N seals)	°C [°F]	-35°~80° [-30°~180°]		
Temperature Range (Viton® seals)	°C [°F]	-30°~120° [-20°~250°]		
Actuation (open/close)	sec	0.10		

### Accessories

Pneumatic Accessories	Model Numbers	Part Number	Qty/Unit
M3 Plumbing Fitting Push-in for 3mm O.D. Tube	All Models	PLFT-021	2
M3 Plumbing Fitting Barb for 2mm I.D. Tube	All Models	PLFT-022	2
Buna-N Seal Repair Kit	All Models	SLKT-121	1
Viton® Seal Repair Kit	All Models	SLKT-121V	1
Top Air Ports Manifold Seal Kit (available in Viton® only)	All Models (RPM)	SLKT-142V	1
Top Air Ports Manifold Seal Kit (available in Viton® only)	All Models (RPMC)	SLKT-143V	1

# RPS SERIES

## 2-Jaw General Industrial Grippers

CLICK OR SCAN

To view full catalog pages on this product



### How To Order

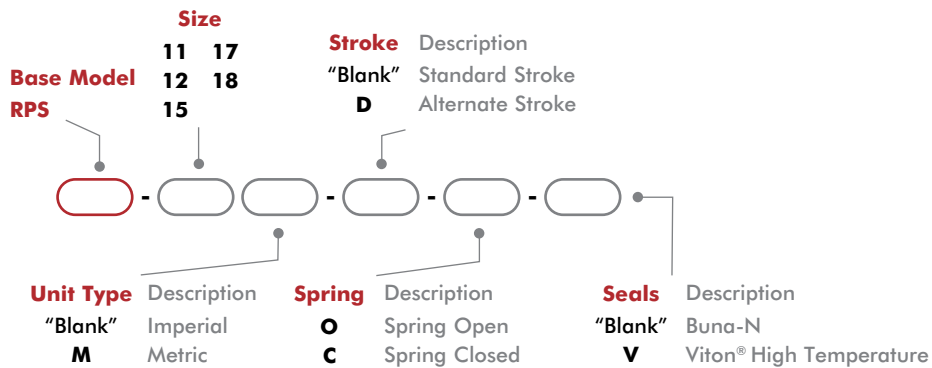

Size	Seal Repair Kits		Fail Safe Valve		Inductive Sensor Mtg Kit (mounts 2 sensors)
	Buna-N	Viton®	Imperial	Metric	
11	SLKT-036	SLKT-036V			
12	SLKT-040	SLKT-040V	OFSV-001	OFSV-004	OSMK-003
15	SLKT-041	SLKT-041V			
17	SLKT-042	SLKT-042V			
18	SLKT-043	SLKT-043V	OFSV-002	OFSV-005	OSMK-072



**CLICK OR SCAN**  
To view full  
catalog pages  
on this product

# RPS SERIES

## 2-Jaw General Industrial Grippers

### Basic Unit Dimensions

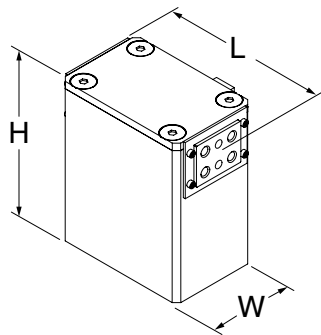

Size	L	W	H
11	48 [1.88]	31.8 [1.25]	44.1 [1.74]
11D	45 [1.79]		
12	63 [2.50]	41.3 [1.63]	51.2 [2.02]
12D	60 [2.37]		
15	81 [3.19]	54.0 [2.13]	71.6 [2.82]
15D	76 [3.00]		
17	107 [4.25]	74.9 [2.95]	98.7 [3.89]
17D	117 [4.60]		
18	177 [7.00]	154.4 [6.08]	
18D	190 [7.45]		

### Technical Data

Specifications	Units	11	11-D	12	12-D	15	15-D
Total Rated Grip Force <b>F</b> @ 100 psi [7 bar]	N [lbs]	222 [50]	378 [85]	267 [60]	400 [90]	400 [90]	110 [489]
Total Stroke	mm [in]	6.4 [0.25]	4 [0.16]	9.5 [0.38]	6 [0.24]	12.7 [0.50]	8 [0.31]
Weight	kg [lbs]	0.16 [0.36]		0.34 [0.76]		0.65 [1.44]	
Pressure Range	bar [psi]	3.4-7 [50-100]					
Displacement	cm <sup>3</sup> [in <sup>3</sup> ]	1.6 [0.098]		2.5 [0.150]		4.9 [0.300]	
Temperature Range (Buna-N seals)	°C [°F]	-35°~80° [-30°~180°]					
Temperature Range (Viton® seals)	°C [°F]	-30°~150° [-20°~300°]					
Actuation	sec	0.15				0.17	

Specifications	Units	17	17-D	18	18-D
Total Rated Grip Force <b>F</b> @ 100 psi [7 bar]	N [lbs]	1334 [300]	180 [800]	2669 [600]	380 [1690]
Total Stroke	mm [in]	19.1 [0.75]	28 [1.10]	31.8 [1.25]	43 [1.70]
Weight	kg [lbs]	1.4 [3.00]		5.0 [11.02]	
Pressure Range	bar [psi]	3-7 [40-100]			
Displacement	cm <sup>3</sup> [in <sup>3</sup> ]	22.9 [1.400]		72.1 [4.400]	
Temperature Range (Buna-N seals)	°C [°F]	-35°~80° [-30°~180°]			
Temperature Range (Viton® seals)	°C [°F]	-30°~150° [-20°~300°]			
Actuation	sec	0.31		0.51	

### Accessories

Sensor Accessories	Model Numbers	Part Number	Qty/Unit
Sensor Mounting Kit for Imperial & Metric Units (mounts 2 sensors)	See Datasheet		1
NPN Inductive Sensor with Quick Disconnect*	11, 12, 15	OISN-019	1-2
PNP Inductive Sensor with Quick Disconnect*	11, 12, 15	OISP-019	1-2
NPN Inductive Sensor with Quick Disconnect*	17, 18	OISN-011	1-2
PNP Inductive Sensor with Quick Disconnect*	17, 18	OISP-011	1-2
Quick Disconnect 2 Meter Cable Length*	All Models	CABL-010	1-2
Quick Disconnect 5 Meter Cable Length*	All Models	CABL-013	1-2
Pneumatic Accessories	Model Numbers	Part Number	Qty/Unit
Fail Safe Valves	See Datasheet		1

\*Sensor and cable sold separately.

Dimensions and technical information are subject to change without notice



# DPW SERIES

## 2-Jaw Heavy-Duty Parallel Grippers

CLICK OR SCAN

To view full catalog pages on this product



### How To Order

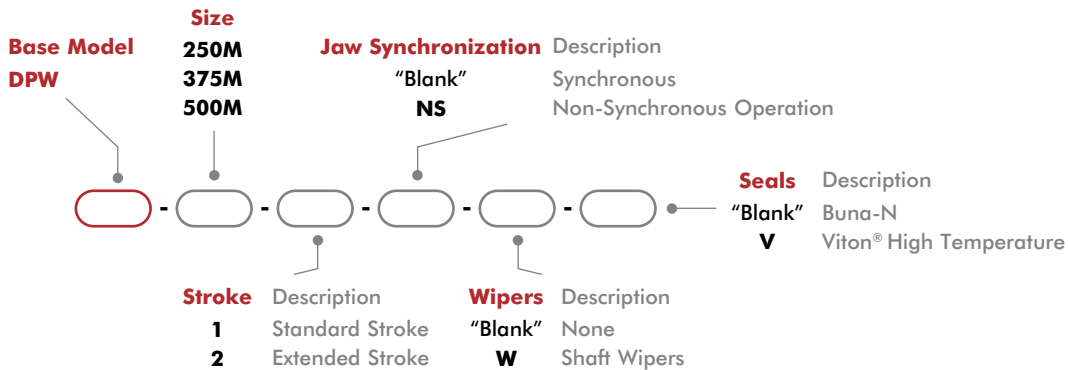
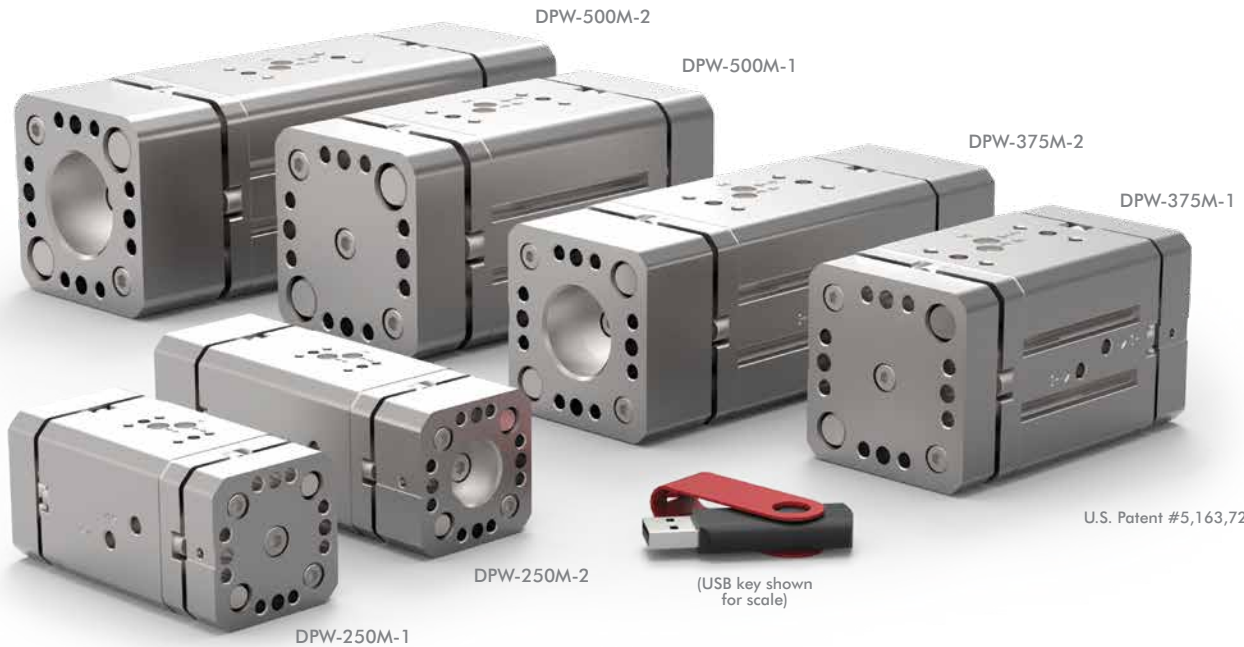

Size	Seal Repair Kits		Manifold Seal Kit Viton®	Shaft Wiper Seal Kit	Inductive Sensor Mtg Kit (3mm or 4mm)
	Buna-N	Viton®			
250M	SLKT-337	SLKT-337V	SLKT-197V	SLKT-338	OSMK-116
375M	SLKT-339	SLKT-339V	SLKT-199V	SLKT-340	OSMK-117
500M	SLKT-341	SLKT-341V		SLKT-342	OSMK-118

### Basic Unit Dimensions

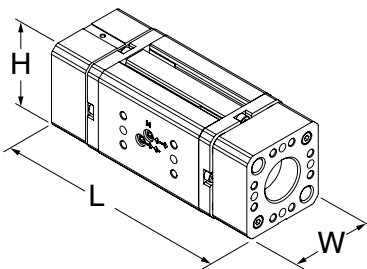

Size	L	W	H
250M-1	98 [3.86]	37.6 [1.48]	37.6 [1.48]
250M-2	136 [5.35]		
375M-1	122 [4.80]	54 [2.13]	54 [2.13]
375M-2	198 [7.80]		
500M-1	164 [6.46]	63 [2.48]	63 [2.48]
500M-2	240 [9.45]		



**CLICK OR SCAN**  
To view full  
catalog pages  
on this product

# DPW SERIES

## 2-Jaw Heavy-Duty Parallel Grippers

### Technical Data

Specifications	Units	250M-1	250M-2	375M-1	375-2
Total Rated Grip Force <b>F</b> @ 100 psi	N [lbs]	222 [50]		445 [100]	
Total Stroke	mm [in]	19.1 [0.75]	31.8 [1.25]	25.4 [1.00]	50.8 [2.00]
Weight	kg [lbs]	0.30 [0.66]	0.39 [0.86]	0.81 [1.80]	1.20 [2.66]
Pressure Range	bar [psi]	1.5-7 [20-100]			
Displacement	cm <sup>3</sup> [in <sup>3</sup> ]	3.8 [0.023]	6.3 [0.383]	11.3 [0.690]	22.6 [1.382]
Temperature Range (Buna-N seals)	°C [°F]	-35°~80° [-30°~180°]			
Temperature Range (Viton® seals)	°C [°F]	-30°~150° [-20°~300°]			
Actuation	sec	0.12	0.14	0.16	0.20

Specifications	Units	500M-1	500M-2
Total Rated Grip Force <b>F</b> @ 100 psi	N [lbs]	800 [180]	
Total Stroke	mm [in]	38.1 [1.50]	63.5 [2.50]
Weight	kg [lbs]	1.48 [3.27]	2.0 [4.39]
Pressure Range	bar [psi]	1.5-7 [20-100]	
Displacement	cm <sup>3</sup> [in <sup>3</sup> ]	30.2 [1.841]	50.3 [3.068]
Temperature Range (Buna-N seals)	°C [°F]	-35°~80° [-30°~180°]	
Temperature Range (Viton® seals)	°C [°F]	-30°~150° [-20°~300°]	
Actuation	sec	0.20	0.28

### Accessories

Sensor Accessories	Model Numbers	Part Number	Qty/Unit
PNP Magneto Resistive Sensor Short Barrel (with Qk. Disc.)*	All Models	OHSP-017	1-4†
NPN Magneto Resistive Sensor Short Barrel (with Qk. Disc.)*	All Models	OHSN-017	1-4†
PNP Magneto Resistive Sensor 90° Barrel (with Qk. Disc.)*	All Models	OHSP-011	1-4†
NPN Magneto Resistive Sensor 90° Barrel (with Qk. Disc.)*	All Models	OHSN-011	1-4†
PNP Inductive Sensor 3mm with Quick Disconnect*	All Models	OISP-019	1-2
NPN Inductive Sensor 3mm with Quick Disconnect.*	All Models	OISN-019	1-2
PNP Inductive Sensor 4mm with Quick Disconnect*	375M, 500M	OISP-014	1-2
NPN Inductive Sensor 4mm with Quick Disconnect*	375M, 500M	OISN-014	1-2
Quick Disconnect 2 Meter Cable Length*	All Models	CABL-010	1-4†
Quick Disconnect 5 Meter Cable Length*	All Models	CABL-013	1-4†

Pneumatic Accessories	Model Numbers	Part Number	Qty/Unit
Fail Safe Valve M5	All Models	OFSV-004	1
Adjustable Flow Control	All Models	VLVF-008	1-2

\*Sensor and cable sold separately. †Except 250-1, 250-2, 1-2 only.

# RPB SERIES

## 2-Jaw Heavy-Duty Parallel Grippers

CLICK OR SCAN

To view full catalog pages on this product



### How To Order

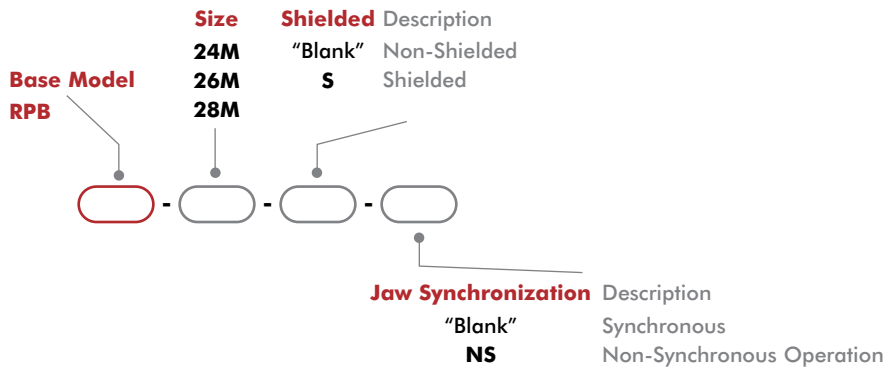

Size	Viton® Seal Repair Kits	Shield/Seal Repair Kit -S Only
24M		SLKT-152V
26M	SLKT-123V	SLKT-153V
28M		SLKT-166V

**CLICK OR SCAN**

To view full catalog pages on this product

# RPB SERIES

## 2-Jaw Heavy-Duty Parallel Grippers

### Basic Unit Dimensions

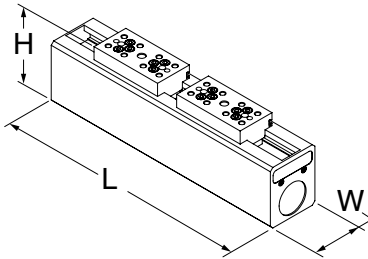

Size	L	W	H
250M	438.2 [17.25]	88.9 [3.50]	129 [5.08]
375M	590.5 [23.25]		
500M	734 [28.90]		

### Technical Data

Specifications	Units	24M, 24M-S	26M, 26M-S	28M, 28M-S
Total Rated Grip Force <b>F</b> @ 100 psi [7 bar]	N [lbs]	2669 [600]		
Total Stroke	mm [in]	101.6 [4]	152.4 [6]	203.2 [8]
Weight	kg [lbs]	10.9 [24]	14.5 [32]	19.1 [42]
Pressure Range	bar [psi]	1.4-7 [20-100]		
Cylinder Bore $\varnothing$	mm [in]	50.8 [2.000]		
Displacement	cm <sup>3</sup> [in <sup>3</sup> ]	204.8 [12.5]	308.1 [18.8]	410 [25]
Temperature Range (Viton® seals)	°C [°F]	-30°~150° [-20°~300°]		
Actuation	sec	0.5	0.75	1.00

### Accessories

Sensor Accessories	Model Numbers	Part Number	Qty/Unit
12mm Sensor Mounting Kit (mounts 2 sensors)	24, 26, 28	OSMK-078	1-2
12mm Sensor Mounting Kit (mounts 2 sensors)	24-S, 26-S, 28-S	OSMK-079	1-2
12mm PNP Inductive Sensor with Quick Disconnect*	All Models	OISP-017	1-4
12mm NPN Inductive Sensor with Quick Disconnect*	All Models	OISN-017	1-4
Quick Disconnect 2 Meter Cable Length*	All Models	CABL-014	1-4

Pneumatic Accessories	Model Numbers	Part Number	Qty/Unit
Fail Safe Valve (Metric)	All Models	OFSV-006	1

\*Sensor and cable sold separately.

# RPR SERIES

## 2-Jaw Heavy-Duty Parallel Grippers

### How To Order

CLICK OR SCAN

To view full catalog pages on this product



(USB key shown for scale)

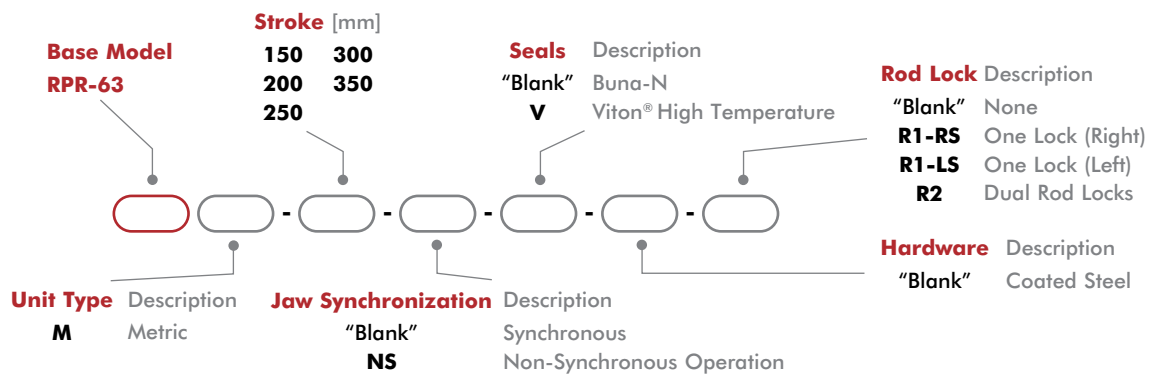

**CLICK OR SCAN**

To view full catalog pages on this product

# RPR SERIES

## 2-Jaw Heavy-Duty Parallel Grippers

### Basic Unit Dimensions

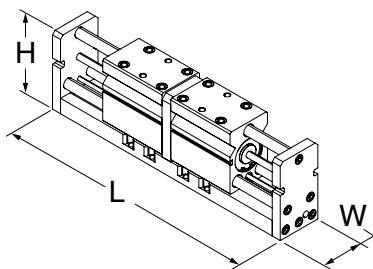

Size	L	W	H
150	489.8 [19.28]	88.9 [3.50]	161.9 [6.37]
200	539.8 [21.25]	88.9 [3.50]	161.9 [6.37]
250	589.8 [23.22]	88.9 [3.50]	161.9 [6.37]
300	639.8 [25.19]	88.9 [3.50]	161.9 [6.37]
350	689.8 [27.16]	88.9 [3.50]	161.9 [6.37]

### Technical Data

Specifications	Units	RPR-63-150	RPR-63-200	RPR-63-250	RPR-63-300	RPR-63-350
Total Rated Grip Force <b>F</b> @ 100 psi	N [lbs]	3250 [800]				
Total Stroke	mm [in]	150 [5.91]	200 [7.87]	250 [9.84]	300 [11.81]	350 [13.78]
Weight	kg [lbs]	13.6 [30]	15.8 [35]	18.1 [40]	20.4 [45]	22.7 [50]
Pressure Range	bar [psi]	3-7 [40-100]				
Displacement	cm <sup>3</sup> [in <sup>3</sup> ]	623 [38.2]				
Temperature Range (Buna-N seals)	°C [°F]	-35°~80° [-30°~180°]				
Temperature Range (Viton® seals)	°C [°F]	-30°~150° [-20°~300]				
Actuation	sec	1.3				

### Accessories

Sensor Accessories	Part Number	Qty/Unit
Sensor Mounting Kit for Imperial & Metric Units (mounts 2 sensors)	OSMK-131	1
12mm PNP Inductive Sensor with Quick Disconnect*	OISP-017	1-2
12mm NPN Inductive Sensor with Quick Disconnect*	OISN-017	1-2
Quick Disconnect 2 Meter Cable Length*	CABL-014	1-2
Quick Disconnect 5 Meter Cable Length*	CABL-018	1-2

Pneumatic Accessories	Part Number	Qty/Unit
Fail Safe Valve 1/4 NPT (Imperial)	OFSV-003	1
Fail Safe Valve 1/4 BSPP (Metric)	OFSV-006	1
Buna-N Seal Repair Kit	SLKT-452	1
Viton® Seal Repair Kit	SLKT-453	1

\*Sensor and cable sold separately.

# RPW SERIES

## 2-Jaw Heavy-Duty Parallel Grippers

CLICK OR SCAN

To view full catalog pages on this product



### How To Order

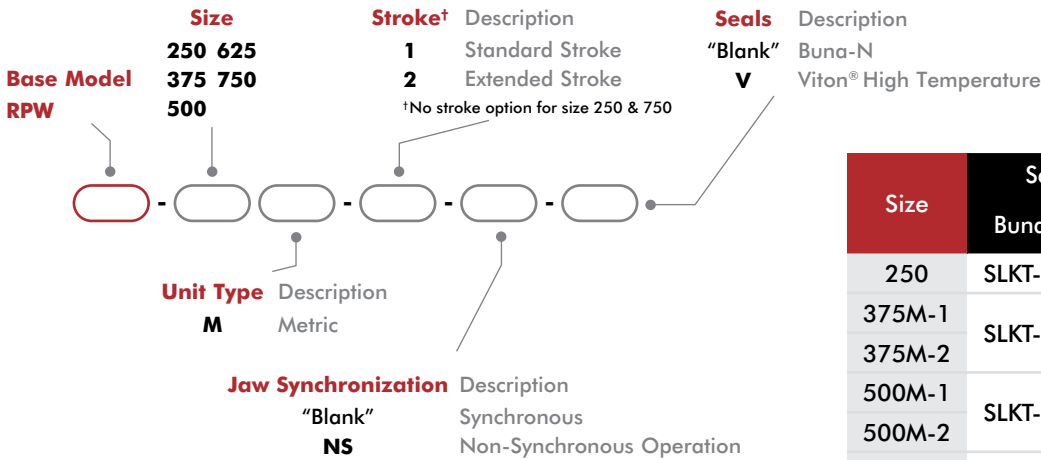

Size	Seal Repair Kits		Inductive Sensor Mtg Kit (2 Sensors)
	Buna-N	Viton®	
250	SLKT-055	SLKT-055V	OSMK-009
375M-1	SLKT-056	SLKT-056V	OSMK-010
375M-2			OSMK-011
500M-1	SLKT-058	SLKT-058V	OSMK-012
500M-2			OSMK-013
625M-1	SLKT-071	SLKT-071V	OSMK-074
625M-2			OSMK-074
750	SLKT-060	SLKT-060V	OSMK-014

### Basic Unit Dimensions

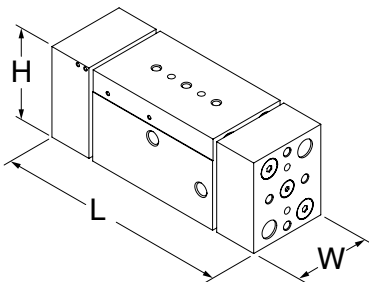

Size	L	W	H
250	93 [3.66]	31.5 [1.24]	40.9 [1.61]
375M-1	120 [4.72]	37.8 [1.49]	50.5 [1.99]
375M-2	187 [7.36]		
500M-1	171 [6.73]	56.9 [2.24]	66.4 [2.61]
500M-2	234 [9.21]		
625M-1	219 [8.62]	66.4 [2.61]	82.3 [3.24]
625M-2	321 [12.64]		
750	410 [16.14]	75 [2.95]	99.8 [3.93]

**CLICK OR SCAN**

To view full catalog pages on this product

# RPW SERIES

## 2-Jaw Heavy-Duty Parallel Grippers

Specifications	Units	250	375-1	375M-2
Total Rated Grip Force <b>F</b> @ 100 psi	N [lbs]	222 [50]	400 [90]	
Total Stroke	mm [in]	19.1 [0.75]	25.4 [1.00]	50.8 [2.00]
Weight	kg [lbs]	0.30 [0.66]	0.59 [1.3]	0.91 [2.0]
Pressure Range	bar [psi]	3-7 [40-100]		
Displacement	cm <sup>3</sup> [in <sup>3</sup> ]	3.8 [0.023]	9.8 [0.600]	19.7 [1.200]
Temperature Range (Buna-N seals)	°C [°F]	-35°~80° [-30°~180°]		
Temperature Range (Viton® seals)	°C [°F]	-30°~150° [-20°~300°]		
Actuation	sec	0.16	0.20	0.25

Specifications	Units	500-1	500-2
Total Rated Grip Force <b>F</b> @ 100 psi	N [lbs]	667 [150]	
Total Stroke	mm [in]	38.1 [1.50]	63.5 [2.50]
Weight	kg [lbs]	1.4 [3.0]	1.85 [4.0]
Pressure Range	bar [psi]	3-7 [40-100]	
Displacement	cm <sup>3</sup> [in <sup>3</sup> ]	29.5 [1.800]	49.2 [3.000]
Temperature Range (Buna-N seals)	°C [°F]	-35°~80° [-30°~180°]	
Temperature Range (Viton® seals)	°C [°F]	-30°~150° [-20°~300°]	
Actuation	sec	0.25	0.33

Specifications	Units	625-1	625-2	750
Total Rated Grip Force <b>F</b> @ 100 psi	N [lbs]	1068 [240]		2091 [470]
Total Stroke	mm [in]	50.8 [2.00]	88.9 [3.50]	114.3 [4.50]
Weight	kg [lbs]	3.0 [6.5]	3.6 [7.8]	6.4 [14]
Pressure Range	bar [psi]	3-7 [40-100]		
Displacement	cm <sup>3</sup> [in <sup>3</sup> ]	21.6 [1.320]	37.9 [2.310]	232.7 [14.200]
Temperature Range (Buna-N seals)	°C [°F]	-35°~80° [-30°~180°]		
Temperature Range (Viton® seals)	°C [°F]	-30°~150° [-20°~300°]		
Actuation	sec	0.52	0.69	1.00

### Accessories

Sensor Accessories	Model Numbers	Part Number	Qty/Unit
Sensor Mounting Kit for Imperial & Metric Units (mounts 2 sensors)	See Datasheet		1
PNP Inductive Sensor with Quick Disconnect*	250, 375, 500	OISP-014	1-2
NPN Inductive Sensor with Quick Disconnect*	250, 375, 500	OISN-014	1-2
PNP Inductive Sensor with Quick Disconnect*	625, 750	OISP-011	1-2
NPN Inductive Sensor with Quick Disconnect*	625, 750	OISN-011	1-2
Quick Disconnect 2 Meter Cable Length*	All Models	CABL-010	1-2
Quick Disconnect 5 Meter Cable Length*	All Models	CABL-013	1-2

Pneumatic Accessories	Model Numbers	Part Number	Qty/Unit
Fail Safe Valve (Imperial)	250, 375	OFSV-001	1
Fail Safe Valve (Metric)	250, 375	OFSV-004	1
Fail Safe Valve (Imperial)	500, 625, 750	OFSV-002	1
Fail Safe Valve (Metric)	500, 625, 750	OFSV-005	1

\*Sensor and cable sold separately.



# 3P SERIES

## 3-Jaw Parallel Grippers

CLICK OR SCAN

To view full catalog pages on this product



### How To Order



Note: See catalog for complete options information.

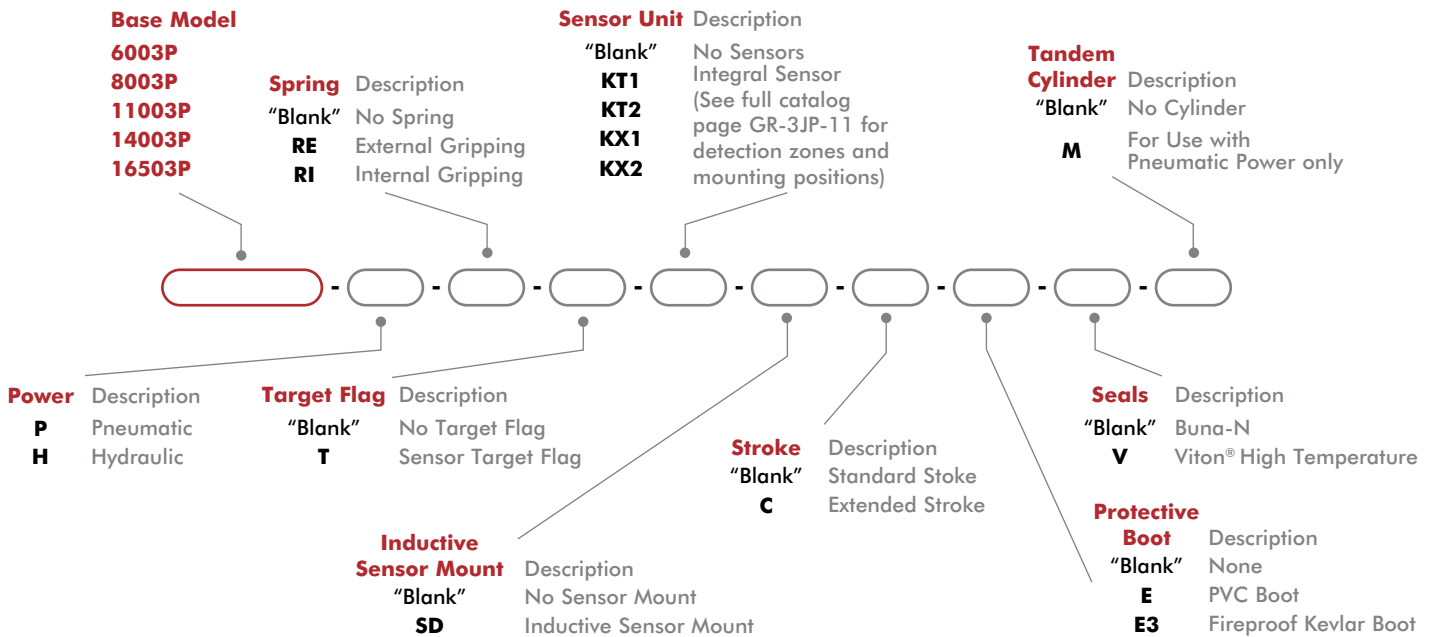

Size	Seal Repair Kits			Protective Boots	
	Buna-N	Viton®	Hydraulic	PVC - Brown or Black	Fireproof KEVLAR - Red
6003P	SLKT-156	SLKT-156V	SLKT-330	ER63P	E3R63P
8003P	S80	S80V	S80H	ER83P	E3R83P
11003P	S100	S110V	S110H	ER113P	E3R113P
14003P	SLKT-333	SLKT-333	SLKT-334	KP-317	KP-319
16503P	SLKT-335	SLKT-335V	SLKT-336	KP-320	KP-322

**CLICK OR SCAN**

To view full catalog pages on this product

# 3P SERIES

## 3-Jaw Parallel Grippers

### Basic Unit Dimensions

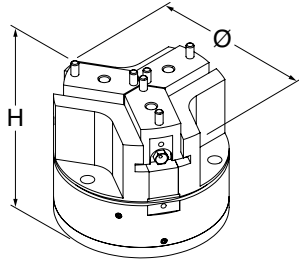

Size	Ø	Ø Max. C	H
6003P	72 [2.83]	78 [3.07]	77 [3.03]
8003P	91.6 [3.61]	98.4 [3.87]	78 [3.07]
11003P	126 [4.96]	136 [5.35]	106 [4.17]
14003P	165 [6.50]	179 [7.05]	137 [5.39]
16503P	194 [7.64]	204 [8.03]	169 [6.65]

### Technical Data

Specifications	Units	6003P-P	6003P-P-C	8003P-P	8003P-P-C	11003P-P	11003P-P-C
Grip Force (F <sub>6</sub> +R) <sub>1</sub> , 6 bar [87 psi], Springs Mid-Way, L=0	N [lbs]	678 [152]	422 [95]	1888 [424]	1219 [274]	1979 [445]	2030 [456]
Grip Force (F <sub>0</sub> +R) <sub>2</sub> , 0 bars, Springs Mid-Way, L=0	N [lbs]	172 [39]	107 [24]	617 [139]	398 [89]	628 [141]	644 [145]
Total Stroke	mm [in]	10 [0.39]	16 [0.63]	13 [0.51]	20 [0.79]	20 [0.79]	30 [1.18]
Weight	kg [lbs]	0.60 [1.32]		0.97 [2.14]		2.35 [5.18]	
Pressure Range	bar [psi]	w/ Spring 4-7 [60-100] , w/o Spring 2-7 [30-100]					
Displacement	cm <sup>3</sup> [in <sup>3</sup> ]	12 [0.73]		35 [2.14]		87 [5.31]	
Temp. Range	°C [°F]	Buna-N -35°~80° [-30°~180°], Viton -30°~150° [-20°~300°]					
Actuation (open/close)	sec.	0.07		0.08		0.10	

Specifications	Units	14003P-P	14003P-P-C	16503P-P	16503P-P-C
Grip Force (F <sub>6</sub> +R) <sub>1</sub> , 6 bar [87 psi], Springs Mid-Way, L=0	N [lbs]	6077 [1366]	4031 [906]	11190 [2515]	6878 [1546]
Grip Force (F <sub>0</sub> +R) <sub>2</sub> , 0 bars, Springs Mid-Way, L=0	N [lbs]	2248 [508]	1490 [335]	3730 [838]	2292 [515]
Total Stroke	mm [in]	26 [1.02]	40 [1.57]	30 [1.18]	50 [1.97]
Weight	kg [lbs]	4.7 [10.36]		9.04 [19.92]	
Pressure Range	bar [psi]	w/ Spring 4-7 [60-100] , w/o Spring 2-7 [30-100]			
Displacement	cm <sup>3</sup> [in <sup>3</sup> ]	220 [13.43]		494 [30.15]	
Temp. Range	°C [°F]	Buna-N -35°~80° [-30°~180°], Viton -30°~150° [-20°~300°]			
Actuation (open/close)	sec.	0.16		0.29	

### Accessories

Sensor Accessories	Model Numbers	Part Number	Qty/Unit
M8 Inductive Sensor PNP with M8 Connector	6003P, 8003P, 11003P	OISP-011	1-4
M8 Inductive Sensor NPN with M8 Connector	6003P, 8003P, 11003P	OISN-011	1-4
M8 Inductive Sensor PNP with M12 Connector	14003P, 16503P	OISP-017	1-4
M8 Inductive Sensor NPN with M12 Connector	14003P, 16503P	OISN-017	1-4
M8 Quick Disconnect 2 Meter Cable Length*	6003P, 8003P, 11003P	CABL-010	1-4
M12 Quick Disconnect 2 Meter Cable Length*	14003P, 16503P	CABL-014	1-4
Inductive Sensor Mounting Kit (1 holder, 1 flag, 2 spacers)	6003P, 8003P	SD60-80P	1-2
Inductive Sensor Mounting Kit (1 holder, 1 flag, 2 spacers)	11003P	SD110P	1-2
Inductive Sensor Mounting Kit (1 holder, 1 flag, 2 spacers)	14003P	OSMK-114	1-2
Inductive Sensor Mounting Kit (1 holder, 1 flag, 2 spacers)	16503P	OSMK-115	1-2

\*Sensor and cable sold separately.

Dimensions and technical information are subject to change without notice

# RTH SERIES

## 3-Jaw Parallel Grippers

CLICK OR SCAN

To view full catalog pages on this product



### How To Order

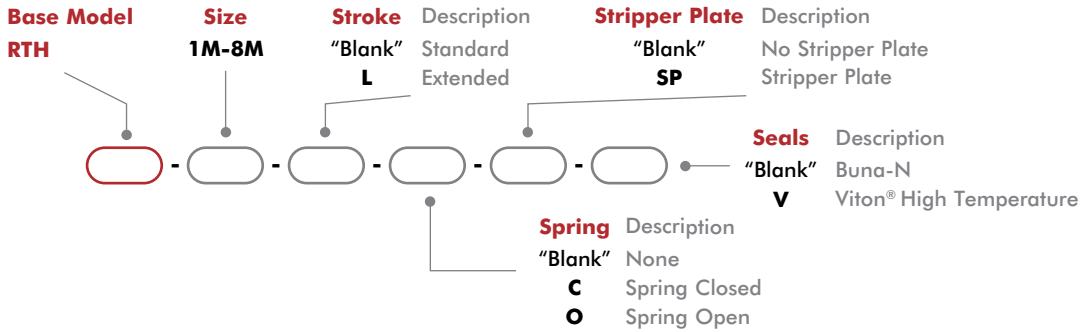
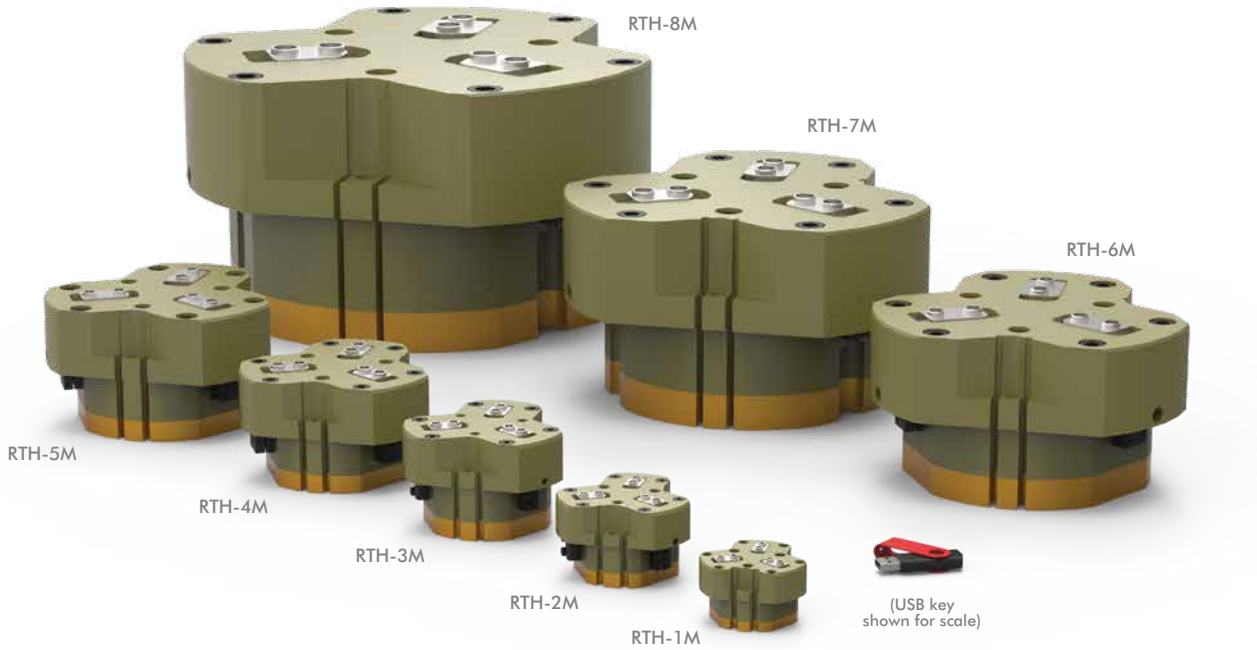

Size	Seal Repair Kits		Rear Inlet Seal Repair Kits	
	Buna-N	Viton®	Buna-N	Viton®
1M	SLKT-347	SLKT-347V	SLKT-363	SLKT-363V
2M	SLKT-348	SLKT-348V	SLKT-364	SLKT-364V
3M	SLKT-349	SLKT-349V	SLKT-365	SLKT-365V
4M	SLKT-350	SLKT-350V	SLKT-366	SLKT-366V

Size	Seal Repair Kits		Rear Inlet Seal Repair Kits	
	BunaN	Viton®	BunaN	Viton®
5M	SLKT351	SLKT351V	SLKT365	SLKT365V
6M	SLKT352	SLKT352V	SLKT366	SLKT366V
7M	SLKT353	SLKT353V		
8M	SLKT354	SLKT354V		

### Basic Unit Dimensions

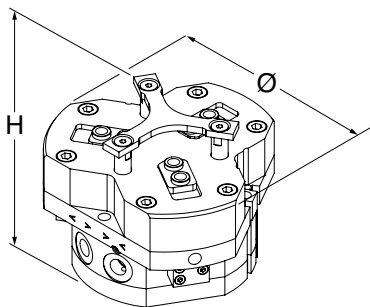

Size	Ø	H
1M	63 [2.48]	43 [1.69]
2M	83 [3.27]	57 [2.24]
3M	104 [4.09]	73.5 [2.89]
4M	129 [5.08]	88.5 [3.48]
5M	162 [6.38]	98.5 [3.88]
6M	205 [8.07]	121 [4.76]
7M	258 [10.16]	155 [6.10]
8M	355 [13.98]	209 [8.23]

**CLICK OR SCAN**

To view full catalog pages on this product

# RTH SERIES

## 3-Jaw Parallel Grippers

Specifications	Units	1M	1M-L	2M	2M-L	3M	3M-L	4M	4M-L
Total Rated Grip Force <b>F</b>	N	682	443	1238	812	2078	1349	3644	2366
@ 100 psi [7 bar] w/o Spring Assist	[lbs]	[153]	[100]	[278]	[183]	[467]	[303]	[819]	[532]
Total Rated Grip Force <b>F</b>	N	889	579	1490	979	2627	1708	4562	2967
@ 100 psi [7 bar] with Spring Assist	[lbs]	[200]	[130]	[335]	[220]	[591]	[384]	[1026]	[667]
Total Stroke	mm	4	8	6	12	8	16	10	20
	[in]	[0.16]	[0.32]	[0.24]	[0.47]	[0.31]	[0.63]	[0.39]	[0.79]
Weight	kg [lbs]	0.25 [0.6]		1.2 [0.53]		1.08 [2.4]		1.95 [4.3]	
Pressure Range w/o Spring	bar [psi]	2-7 [30-100]							
Pressure Range with Spring	bar [psi]	4-7 [60-100]			3.5-7 [50-100]			3-7 [45-100]	
Max. Vacuum for Scavenge Port	mm Hg [in Hg]	200 [8]							
Max. Pressure for Purge Port	bar [psi]	2.1 [30]							
Displacement	cm <sup>3</sup> [in <sup>3</sup> ]	6.5 [0.40]		17 [1.05]		37 [2.30]		80 [4.90]	
Temperature Range	°C [°F]	Buna-N -35°~80° [-30°~180°], Viton -30°~150° [-20°~300°]							
Actuation (open/close)	sec.	0.06		0.07		0.08		0.1	

Specifications (cont.)	Units	5M	5M-L	6M	6M-L	7M	7M-L	8M	8M-L
Total Rated Grip Force <b>F</b>	N	6353	4125	10202	6629	17165	11102	35288	22784
@ 100 psi [7 bar] w/o Spring Assist	[lbs]	[1428]	[927]	[2294]	[1490]	[3859]	[2496]	[7933]	[5122]
Total Rated Grip Force <b>F</b>	N	7877	5124	13786	8971	22093	14322	44354	28690
@ 100 psi [7 bar] with Spring Assist	[lbs]	[1771]	[1152]	[3099]	[2017]	[4967]	[3222]	[9971]	[6450]
Total Stroke	mm	13	26	16	32	25	50	35	70
	[in]	[0.51]	[1.02]	[0.63]	[1.26]	[0.98]	[1.97]	[1.38]	[2.76]
Weight	kg [lbs]	3.9 [8.6]		7.89 [17.4]		15.7 [34.6]		43.9 [96.8]	
Pressure Range w/o Spring	bar [psi]	2-7 [30-100]							
Pressure Range with Spring	bar [psi]	3-7 [45-100]		4-7 [55-100]			3.5-7 [50-100]		
Max. Vacuum for Scavenge Port	mm Hg [in Hg]	20 [8]							
Max. Pressure for Purge Port	bar [psi]	2.1 [30]							
Displacement	cm <sup>3</sup> [in <sup>3</sup> ]	180 [11.0]		355 [22]		940 [57]		2720 [166]	
Temperature Range	°C [°F]	Buna-N -35°~80° [-30°~180°], Viton -30°~150° [-20°~300°]							
Actuation (open/close)	sec.	0.19		0.236		0.85		1.7	

### Accessories

Sensor Accessories	Model Numbers	Part Number	Qty/Unit
8mm PNP Magneto Resistive Sensor (90° barrel) w/ M8 Qk. Disc*	All Models	OHSP-011	1-3†
8mm NPN Magneto Resistive Sensor (90° barrel) w/ M8 Qk. Disc*	All Models	OHSN-011	1-3†
8mm PNP Magneto Resistive Sensor Short Barrel w/ M8 Qk Disc*	All Models	OHSP-017	1-3†
8mm NPN Magneto Resistive Sensor Short Barrel w/ M8 Qk Disc*	All Models	OHSN-017	1-3†
8mm PNP Inductive Sensor w/ M12 Quick Disconnect*	RTH-4M, -5M, -6M	OISP-011	1-3
8mm NPN Inductive Sensor w/ M12 Quick Disconnect*	RTH-4M, -5M, -6M	OISN-011	1-3
12mm PNP Inductive Sensor w/ M12 Quick Disconnect*	RTH-7M, -8M	OISP-017	1-3
12mm NPN Inductive Sensor w/ M12 Quick Disconnect*	RTH-7M, -8M	OISN-017	1-3
M8 Quick Disconnect 2 Meter Cable Length*	All Models	CABL-010	1-3
M8 Quick Disconnect 5 Meter Cable Length*	All Models	CABL-013	1-3
M12 Quick Disconnect 2 Meter Cable Length*	RTH-7M, -8M	CABL-014	1-3†
M12 Quick Disconnect 5 Meter Cable Length*	RTH-7M, -8M	CABL-018	1-3†

Pneumatic Accessories	Model Numbers	Part Number	Qty/Unit
M5 Adjustable Flow Control	RTH-1M, -2M, -3M	VLVF-008	1-2
G 1/8" 90° Adjustable Flow Control	RTH-4M, -5M, -6M, -7M	VLVF-005	1-2
G 1/4" Adjustable Flow Control	RDH-8M	VLVF-010	1-2

\* Sensor and cable sold separately. † Except RTH-1, 1-2 only.

Dimensions and technical information are subject to change without notice

# PPC SERIES

## 3-Jaw Parallel Grippers

CLICK OR SCAN

To view full catalog pages on this product



### How To Order

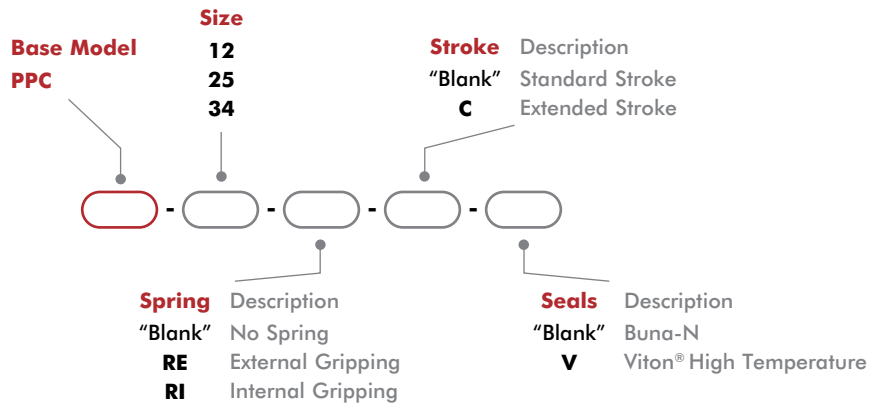

### Basic Unit Dimensions

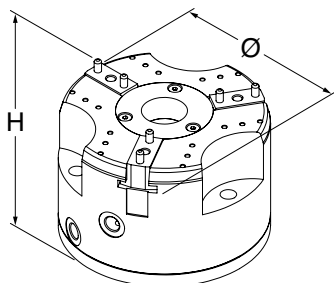

Size	Ø	H
12	43 [1.69]	74 [2.91]
12-C	49.03 [1.93]	78 [3.07]
25	61.5 [2.42]	87 [3.43]
25-C	68.5 [2.70]	92 [3.62]
34	82.5 [3.25]	112 [4.41]
34-C	92.5 [3.64]	117 [4.61]

**CLICK OR SCAN**

To view full catalog pages on this product

# PPC SERIES

## 3-Jaw Parallel Grippers

### Technical Data

Specifications	Units	12	12-C	25	25-C
Total Rated Grip Force <b>F</b> @ 100 psi [7 bar]*	N [lbs]	1474 [331]	896 [201]	2620 [589]	1642 [369]
Total Stroke	mm [in]	10 [0.394]	16 [0.630]	13 [0.512]	20 [0.787]
Weight	kg [lbs]	1.0 [2.2]	1.1 [2.4]	2.2 [4.9]	2.3 [5.1]
Pressure Range (without spring)	bar [psi]	2-7 [30-100]			
Pressure Range (with spring)	bar [psi]	3-7 [45-100]			
Displacement	cm <sup>3</sup> [in <sup>3</sup> ]	23 [1.40]		51 [3.11]	
Temperature Range (Buna-N seals)	°C [°F]	-35°~80° [-30°~180°]			
Temperature Range (Viton® seals)	°C [°F]	-30°~150° [-20°~300°]			
Actuation (open/close)	sec.	0.03		0.04	

Specifications	Units	34	34-C
Total Rated Grip Force <b>F</b> @ 100 psi [7 bar]*	N [lbs]	4332 [974]	2938 [638]
Total Stroke	mm [in]	20 [0.787]	30 [1.181]
Weight	kg [lbs]	5.1 [11.2]	5.3 [11.7]
Pressure Range (without spring)	bar [psi]	2-7 [30-100]	
Pressure Range (with spring)	bar [psi]	3-7 [45-100]	
Displacement	cm <sup>3</sup> [in <sup>3</sup> ]	128 [7.81]	
Temperature Range (Buna-N seals)	°C [°F]	-35°~80° [-30°~180°]	
Temperature Range (Viton® seals)	°C [°F]	-30°~150° [-20°~300°]	
Actuation (open/close)	sec.	0.06	

\*With springs

### Accessories

Sensor Accessories	Model Numbers	Part Number	Qty/Unit
Inductive Sensor Mounting Kit (1 Holder, 1 Flag, 2 Spacers)	PPC-12	OSMK-105	1-2
Inductive Sensor Mounting Kit (1 Holder, 1 Flag, 2 Spacers)	PPC-25	OSMK-106	1-2
Inductive Sensor Mounting Kit (1 Holder, 1 Flag, 2 Spacers)	PPC-34	OSMK-107	1-2
NPN Inductive Sensor with Quick Disconnect*	All Models	OISN-011	1-4
PNP Inductive Sensor with Quick Disconnect*	All Models	OISP-011	1-4
Quick Disconnect Cable (2 meters long)*	All Models	CABL-010	1-4
Quick Disconnect Cable (5 meters long)*	All Models	CABL-013	1-4

\*Sensor and cable sold separately.

# REP3 SERIES

## 3-Jaw Parallel Grippers

### How To Order

CLICK OR SCAN

To view full catalog pages on this product



(USB key shown for scale)

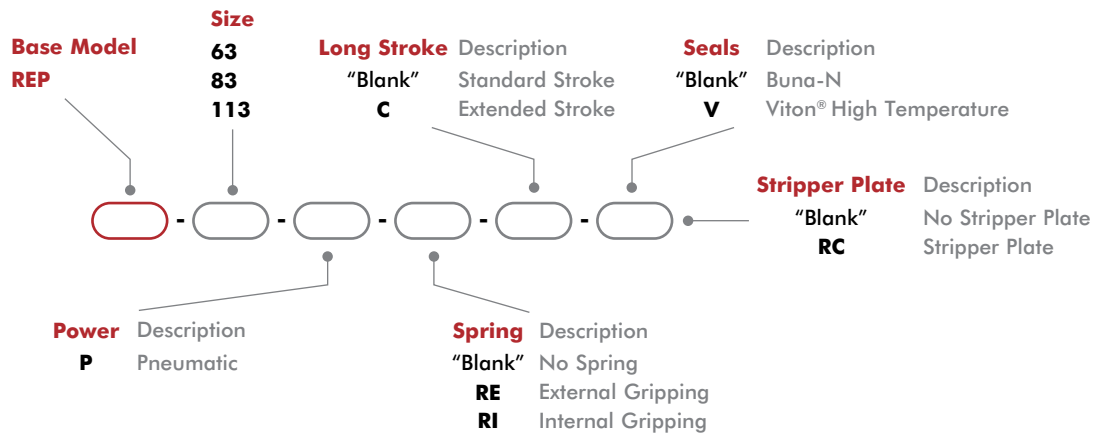

Size	Seal Repair Kits	
	Buna-N	Viton®
63P	SLKT-155	SLKT-155V
83P	SLKT-157	SLKT-157V
113P	SLKT-158	SLKT-158V

**CLICK OR SCAN**

To view full catalog pages on this product

# REP3 SERIES

## 3-Jaw Parallel Grippers

### Basic Unit Dimensions

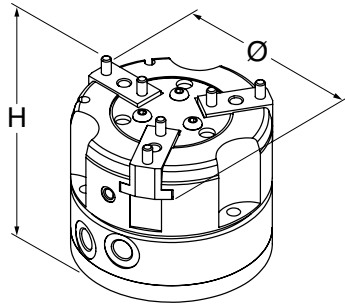

Size	Ø	H
63P	72 [2.83]	77 [3.03]
63P-C	78 [3.07]	
83P	91.6 [3.61]	78 [3.07]
83P-C	98.4 [3.87]	
113P	126 [4.96]	103 [4.06]
113P-C	136 [5.35]	

### Technical Data

Specifications	Units	63	63-C	83	83-C	113	113-C
Total Rated Grip Force <b>F</b> @ 100 psi [7 bar]*	N [lbs]	753 [169]	469 [105]	2077 [467]	1341 [301]	3268 [735]	2180 [490]
Total Stroke	mm [in]	10 [0.394]	16 [0.630]	13 [0.512]	20 [0.787]	20 [0.787]	30 [1.181]
Weight	kg [lbs]	0.55 [1.2]		0.9 [2.0]		2.45 [5.4]	
Pressure Range w/o Spring	bar [psi]	2-7 [30-100]					
Pressure Range with Spring	bar [psi]	3-7 [45-100]					
Displacement	cm <sup>3</sup> [in <sup>3</sup> ]	12 [0.72]		35 [2.13]		87 [5.31]	
Temperature Range (Buna-N seals)	°C [°F]	-35°~80° [-30°~180°]					
Temperature Range (Viton® seals)	°C [°F]	-30°~150° [-20°~300°]					
Actuation (open/close)	sec.	0.10		0.18		0.35	

\* with springs

### Accessories

Sensor Accessories	Model Numbers	Part Number	Qty/Unit
NPN Inductive Sensor with M8 Quick Disconnect*	All Models	OISN-011	1-4
PNP Inductive Sensor with M8 Quick Disconnect*	All Models	OISP-011	1-4
NPN Magneto Resistive Sensor with Quick Disconnect*	All Models	OHSN-006	1-2
PNP Magneto Resistive Sensor with Quick Disconnect*	All Models	OHSP-006	1-2
NPN Magneto Resistive Sensor (Short Barrel) with Qk Disconnect*	All Models	OHSN-008	1-2
PNP Magneto Resistive Sensor (Short Barrel) with Qk Disconnect*	All Models	OHSP-008	1-2
M8 Quick Disconnect 2 Meter Cable Length*	All Models	CABL-010	1-4
M8 Quick Disconnect 2 Meter Cable Length*	All Models	CABL-013	1-4
Inductive Sensor Kit (Mounts 2 Sensors)	63	OSMK-105	1-2
Inductive Sensor Kit (Mounts 2 Sensors)	83	OSMK-106	1-2
Inductive Sensor Kit (Mounts 2 Sensors)	113	OSMK-107	1-2

\* Sensor and cable sold separately.



# RPC SERIES

## 3-Jaw Parallel Grippers

CLICK OR SCAN

To view full catalog pages on this product



### How To Order

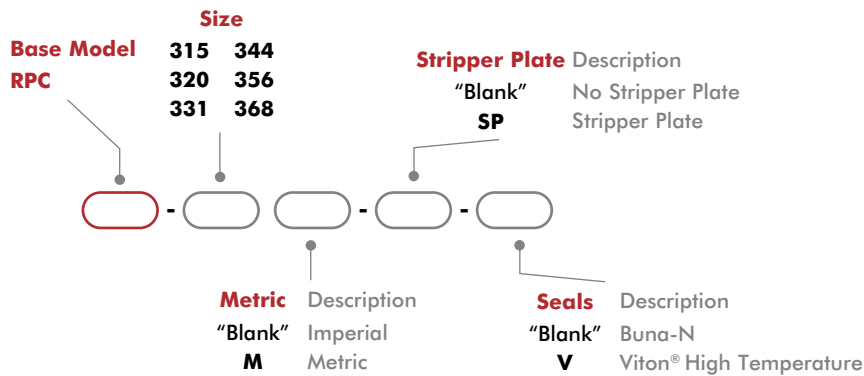

### Basic Unit Dimensions

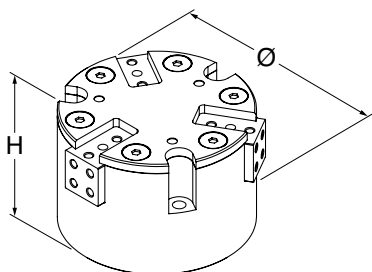

Size	Ø	H
315	62 [2.44]	41 [1.61]
320	82 [3.23]	50 [1.97]
331	118 [4.65]	75.1 [2.96]
344	140 [5.51]	82.2 [3.24]
356	184 [7.24]	101.1 [3.98]
368	206 [8.11]	118 [4.65]



### Technical Data

Specifications	Units	315	320	331
Total Rated Grip Force <b>F</b> @ 100 psi [7 bar]*	N [lbs]	445 [100]	1334 [300]	3336 [750]
Total Stroke	mm [in]	7.6 [0.30]	10.2 [0.40]	15.7 [0.62]
Weight	kg [lbs]	0.24 [0.53]	0.45 [1.0]	1.4 [3.0]
Pressure Range	bar [psi]	1.4-7 [20-100]		
Displacement	cm <sup>3</sup> [in <sup>3</sup> ]	5.2 [0.32]	17.7 [1.08]	52.3 [3.31]
Temperature Range (Buna-N seals)	°C [°F]	-35°~80° [-30°~180°]		
Temperature Range (Viton® seals)	°C [°F]	-30°~150° [-20°~300°]		
Actuation	sec.	0.12	0.18	0.23

Specifications	Units	344	356	368
Total Rated Grip Force <b>F</b> @ 100 psi [7 bar]*	N [lbs]	4003 [900]	6339 [1425]	13345 [3000]
Total Stroke	mm [in]	22.2 [0.88]	28.4 [1.12]	34.9 [1.38]
Weight	kg [lbs]	2.7 [6.0]	4.4 [9.75]	7.3 [16]
Pressure Range	bar [psi]	1.4-7 [20-100]		
Displacement	cm <sup>3</sup> [in <sup>3</sup> ]	120 [7.37]	253 [13.46]	424 [25.86]
Temperature Range (Buna-N seals)	°C [°F]	-35°~80° [-30°~180°]		
Temperature Range (Viton® seals)	°C [°F]	-30°~150° [-20°~300°]		
Actuation	sec.	0.47	0.50	0.74

\*With springs

### Accessories

Sensor Accessories	Model Numbers	Part Number	Qty/Unit
4mm NPN Magneto Resistive Sensor with Quick Disconnect*	All Models	OHSN-017	1-2
4mm PNP Magneto Resistive Sensor with Quick Disconnect*	All Models	OHSP-017	1-2
4mm NPN 90° Magneto Resistive Sensor with Quick Disconnect*	All Models	OHSN-011	1-2
4mm PNP 90° Magneto Resistive Sensor with Quick Disconnect*	All Models	OHSP-011	1-2
Quick Disconnect Cable (2 meters long)*	All Models	CABL-010	1-2
Quick Disconnect Cable (5 meters long)*	All Models	CABL-013	1-2
Fail Safe Valve (Imperial)	315, 320, 331	OFSV-001	1
Fail Safe Valve (Metric)	315, 320, 331	OFSV-004	1
Fail Safe Valve (Imperial)	344, 356, 368	OFSV-002	1
Fail Safe Valve (Metric)	344, 356, 368	OFSV-005	1

\*Sensor and cable sold separately.

# CT/DCT & CT-RE/DCT-RE SERIES

CLICK OR SCAN

To view full catalog pages on this product



## Angular Grippers

### How To Order



Base Model	Size	Seals	Description
DCT (sizes 12-25 only)	12M 25M 50M	"Blank"	Buna-N
CT (sizes 32-50 only)	16M 32M 20M 40M	V	Viton® High Temperature

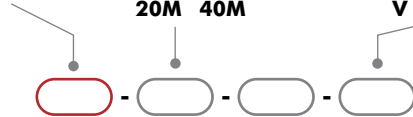

Spring	Description
"Blank"	None
RE	Spring Closed

Size	Seal Repair Kits		Adjustment Stop Kit (1 shielded plate, 1 stop)	Inductive Sensor Mounting Kit (mounts 2 sensors)
	Buna-N	Viton®		
12M/12M-RE	SLKT-159	SLKT-159V	KP-DCT12-BR	N/A
16M/16M-RE	SLKT-160	SLKT-160V	KP-DCT16-BR	SDCT-16-20
20M/20M-RE	SLKT-161	SLKT-161V	KP-DCT20-BR	
25M/25M-RE	SLKT-162	SLKT-162V	KP-DCT25-BR	SDCT-25-32
32M/32M-RE	SLKT-163	SLKT-163V	KP-CT32-BR	
40M/40M-RE	SLKT-164	SLKT-164V	KP-CT40-BR	
50M/50M-RE	SLKT-165	SLKT-165V	KP-CT50-BR	SDCT-40-63

### Basic Unit Dimensions

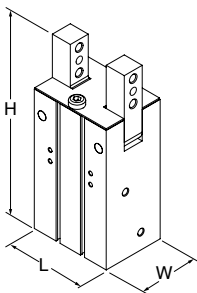

Size	L	W	H -CT	H -CT-RE
12M	30 [1.18]	20 [0.79]	48 [1.89]	64 [2.52]
16M	36 [1.42]	25 [0.98]	64 [2.52]	71 [2.80]
20M	42 [1.65]	30 [1.18]	79 [3.11]	83 [3.27]
25M	50 [1.97]	36 [1.42]	93.5 [3.68]	102 [4.02]
32M	56 [2.20]	42 [1.65]	95 [3.74]	116 [4.57]
40M	66 [2.60]	52 [2.05]	107.5 [4.23]	135 [5.31]
50M	76 [2.99]	62 [2.44]	146 [5.75]	163 [6.42]



**CLICK OR SCAN**  
To view full  
catalog pages  
on this product

# CT/DCT & CT-RE/DCT-RE SERIES

## Angular Grippers

### Technical Data

Specifications	Units	12M	12M-RE	16M	16M-RE	20M	20M-RE	25M	25M-RE
Total Rated Grip Force <b>F</b> @ 100 psi [7 bar]	N [lb]	32 [7.2]	40 [9]	70 [16]	87 [19]	112 [25]	141 [32]	157 [35]	199 [45]
Stroke		90° per finger (180° total)							
Weight	kg [lbs]	0.09 [0.20]	0.12 [0.26]	0.16 [0.35]	0.20 [0.44]	0.28 [0.62]	0.33 [0.73]	0.49 [1.08]	0.57 [1.26]
Pressure Range	bar [psi]	<b>CT/DCT</b> w/spring 3-7 [40-100], <b>CT-RE/DCT-RE</b> w/o spring 4-7 [60-100]							
Ingress Protection Class (IP)		IP43							
Displacement	cm <sup>3</sup> [in <sup>3</sup> ]	1.92 [0.117]		4.12 [0.251]		7.92 [0.483]		14.9 [0.909]	
Temperature Range (Buna-N seals)	°C [°F]	-35°~80° [-30°~180°]							
Temperature Range (Viton® seals)	°C [°F]	-30°~150° [-20°~300°]							
Actuation (open)	sec	0.06	0.08	0.13	0.15	0.16	0.20	0.21	0.25
Actuation (close)	sec	0.06	0.05	0.13	0.12	0.16	0.14	0.21	0.19

Specifications	Units	32M	32M-RE	40M	40M-RE	50M	50M-RE
Total Rated Grip Force <b>F</b> @ 100 psi [7 bar]	N [lb]	272 [61]	353 [79]	446 [100]	592 [133]	651 [146]	893 [201]
Stroke		90° per finger (180° total)					
Weight	kg [lbs]	0.72 [1.59]	0.83 [1.83]	1.18 [2.60]	1.39 [3.06]	1.82 [4.01]	2.21 [4.87]
Pressure Range	bar [psi]	<b>CT/DCT</b> w/spring 3-7 [40-100], <b>CT-RE/DCT-RE</b> w/o spring 4-7 [60-100]					
Ingress Protection Class (IP)		IP43					
Displacement	cm <sup>3</sup> [in <sup>3</sup> ]	28.6 [1.745]		52 [3.173]		92 [5.614]	
Temperature Range (Buna-N seals)	°C [°F]	-35°~80° [-30°~180°]					
Temperature Range (Viton® seals)	°C [°F]	-30°~150° [-20°~300°]					
Actuation (open)	sec	0.29	0.35	0.41	0.47	0.46	0.54
Actuation (close)	sec	0.29	0.26	0.41	0.38	0.46	0.42

### Accessories

Sensor Accessories	Model Numbers	Part Number	Qty/Unit
NPN Magneto Resistive Sensor with M8 Quick Disconnect	All Models	OHSN-017	1-2
PNP Magneto Resistive Sensor with M8 Quick Disconnect	All Models	OHSP-017	1-2
Inductive Sensor Mounting Kit (mounts 2 sensors)	See Above		1
4mm NPN Inductive Sensor with M8 Quick Disconnect*	16M, 20M	OISN-014	1-2
4mm PNP Inductive Sensor M8 with Quick Disconnect*	16M, 20M	OISP-014	1-2
M8 NPN Inductive Sensor with M8 Quick Disconnect*	25M, 32M	OISN-011	1-2
M8 PNP Inductive Sensor with M8 Quick Disconnect*	25M, 32M	OISP-011	1-2
M12 NPN Inductive Sensor with M12 Quick Disconnect*	40M, 50M	OISN-017	1-2
M12 PNP Inductive Sensor with M12 Quick Disconnect*	40M, 50M	OISP-017	1-2
M8 Quick Disconnect 2 Meter Cable Length*	All Models	CABL-010	1-2
M8 Quick Disconnect 5 Meter Cable Length*	All Models	CABL-013	1-2
M12 Quick Disconnect 2 Meter Cable Length*	All Models	CABL-014	1-2
M12 Quick Disconnect 5 Meter Cable Length*	All Models	CABL-018	1-2

Pneumatic Accessories	Model Numbers	Part Number	Qty/Unit
Adjustable Flow Control-M5 Elbow-6mm OD Push-in	12M, 16M, 20M, 25M, 32M	VLVF-008	1-2
Adjustable Flow Control-G1/8 Elbow-6mm OD Push-in	40M, 50M	VLVF-005	1-2

\*Sensor and cable sold separately.

Dimensions and technical information are subject to change without notice

# RA (CAM DRIVEN) SERIES

## Angular Grippers

### How To Order

CLICK OR SCAN

To view full catalog pages on this product

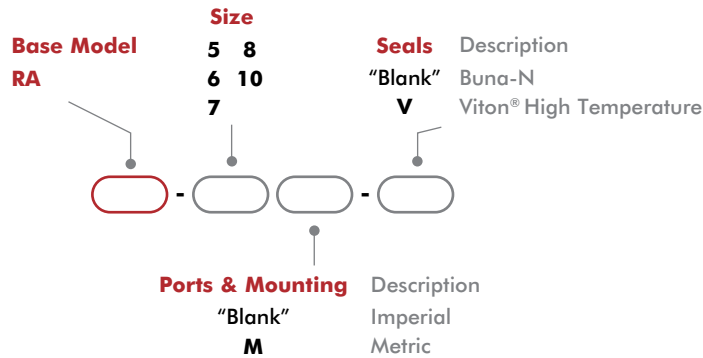
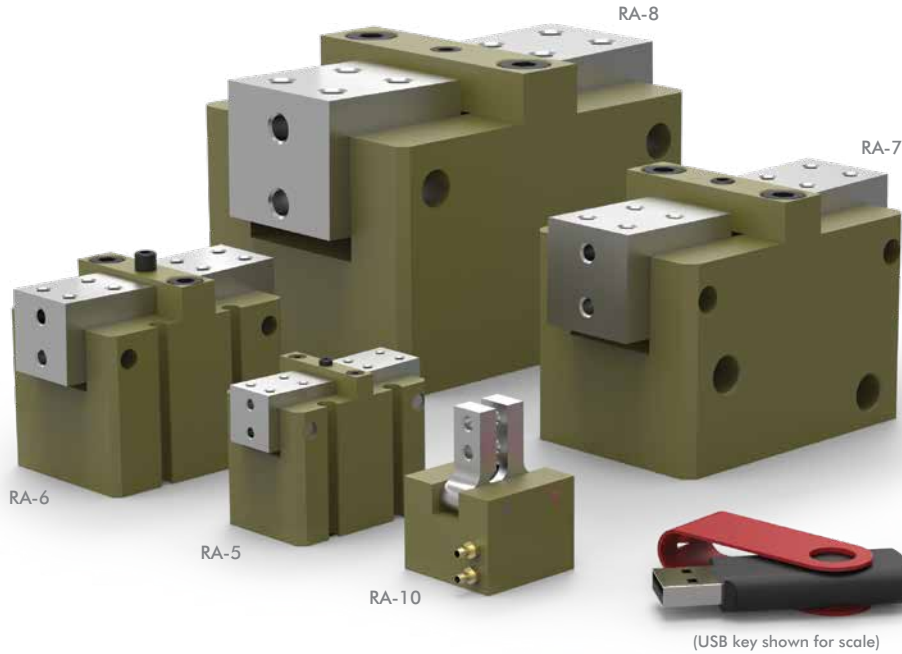

Size	Seal Repair Kits	
	Buna-N	Viton®
5	SLKT-022	SLKT-022V
6	SLKT-023	SLKT-023V
7	SLKT-118	SLKT-118V
8	SLKT-119	SLKT-119V
10	SLKT-018	SLKT-018V

### Basic Unit Dimensions

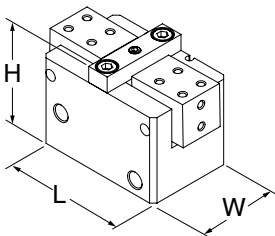

Size	L	W	H
5	25.4 [1.00]	38.1 [1.50]	35.0 [1.38]
6	38.1 [1.50]	50.8 [2.00]	49.6 [1.95]
7	50.8 [2.00]	76.2 [3.00]	60.8 [2.39]
8	76.2 [3.00]	101.6 [4.00]	76.2 [3.00]
10	25.4 [1.00]	25.4 [1.00]	20.7 [0.81]

**CLICK OR SCAN**

To view full catalog pages on this product

# RA (CAM DRIVEN) SERIES

## Angular Grippers

### Technical Data

Specifications	Units	5	6	7
Total Rated Grip Force <b>F</b> @ 7 bar [100 psi]	N [lbs]	89 [20]	196 [44]	534 [120]
Total Stroke		15° per finger (30° total)		
Open Stroke Adjustment		15° per finger (30° total)		10° per finger (20° total)
Weight	kg [lbs]	0.11 [0.25]	0.31 [0.69]	0.8 [1.8]
Pressure Range	bar [psi]	3-7 [40-100]		
Ingress Protection Class (IP)		IP43		
Displacement	cm <sup>3</sup> [in <sup>3</sup> ]	2.1 [0.13]	4.9 [0.300]	9.8 [0.601]
Temperature Range (Buna-N seals)	°C [°F]	-35°~80° [-30°~180°]		
Temperature Range (Viton® seals)	°C [°F]	-30°~150° [-20°~300°]		
Actuation	sec	0.10	0.11	0.15

Specifications	Units	8	10
Total Rated Grip Force <b>F</b> @ 7 bar [100 psi]	N [lbs]	801 [180]	71 [16]
Total Stroke		15° per finger (30° total)	
Open Stroke Adjustment		10° per finger (20° total)	--
Weight	kg [lbs]	2.1 [4.6]	0.03 [0.063]
Pressure Range	bar [psi]	3-7 [40-100]	
Ingress Protection Class (IP)		IP43	
Displacement	cm <sup>3</sup> [in <sup>3</sup> ]	21.6 [1.320]	0.4 [0.026]
Temperature Range (Buna-N seals)	°C [°F]	-35°~80° C [-30°~180° F]	
Temperature Range (Viton® seals)	°C [°F]	-30°~150° C [-20°~300° F]	
Actuation	sec	0.23	0.08

### Accessories

Sensor Accessories	Model Numbers	Part Number	Qty/Unit
NPN Magneto Resistive Sensor with Quick Disconnect*	5, 6, 7, 8	OHSN-017	1-2
PNP Magneto Resistive Sensor with Quick Disconnect*	5, 6, 7, 8	OHSP-017	1-2
NPN Magneto Resistive Sensor 90° with Quick Disconnect*	5, 6, 7, 8	OHSN-011	1-2
PNP Magneto Resistive Sensor 90° with Quick Disconnect*	5, 6, 7, 8	OHSP-011	1-2
Quick Disconnect 2 Meter Cable Length*	5, 6, 7, 8	CABL-010	1-2
Quick Disconnect 5 Meter Cable Length*	5, 6, 7, 8	CABL-013	1-2

Pneumatic Accessories	Model Numbers	Part Number	Qty/Unit
Fail Safe Valve (Imperial)	5, 6	OFSV-001	1
Fail Safe Valve (Metric)	5, 6	OFSV-004	1
Fail Safe Valve (Imperial)	7, 8	OFSV-002	1
Fail Safe Valve (Metric)	7, 8	OFSV-005	1

\*Sensor and cable sold separately.

# RA (TOGGLE LOCK) SERIES

## Angular Grippers

### How To Order

CLICK OR SCAN

To view full catalog pages on this product



(USB key shown for scale)

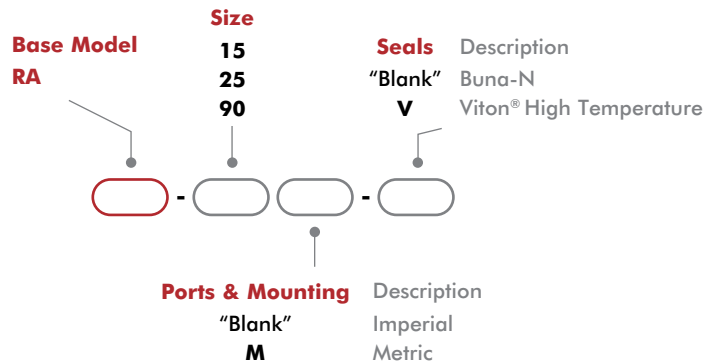

Size	Inductive Sensor Mounting Kit (mounts 2 sensors)	Seal Repair Kits	
		Buna-N	Viton®
15	OSMK-018	SLKT-019	SLKT-019V
25	OSMK-019	SLKT-020	SLKT-020V
90	OSMK-003	SLKT-024	SLKT-024V

**CLICK OR SCAN**

To view full catalog pages on this product

# RA (TOGGLE LOCK) SERIES

Angular Grippers

## Basic Unit Dimensions

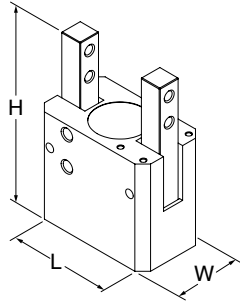

Size	L	W	H
15	25.4 [1.00]	44.5 [1.75]	38.9 [1.53]
25	44.5 [1.75]	63.5 [2.50]	61.9 [2.44]
90	39 [1.54]	28 [1.10]	67.3 [2.65]

## Technical Data

Specifications	Units	15	25	90
Total Rated Grip Force <b>F</b> @ 100 psi [7 bar]	N [lbs]	311 [70]	1112 [250]	356 [80]
Total Stroke		6° per finger (12° total)		90° per finger (180° total)
Stroke Adjustment		--		45° per finger (90° total)
Weight	kg [lbs]	0.14 [0.31]	0.48 [1.06]	0.20 [0.438]
Pressure Range	bar [psi]	3-7 [40-100]		
Ingress Protection Class (IP)		IP43		
Displacement	cm <sup>3</sup> [in <sup>3</sup> ]	1.8 [0.110]	0.8 [0.046]	7.5 [0.460]
Temperature Range (Buna-N seals)	°C [°F]	-35°~80° [-30°~180°]		
Temperature Range (Viton® seals)	°C [°F]	-30°~150° [-20°~300°]		
Actuation	sec	0.10	0.12	0.16

## Accessories

Sensor Accessories	Model Numbers	Part Number	Qty/Unit
Sensor Mounting Kit, Mounts 2 Inductive Sensors (Imperial/Metric)	See Datasheet		1
NPN Inductive Sensor with Quick Disconnect*	15	OISN-019	1-2
PNP Inductive Sensor with Quick Disconnect*	15	OISP-019	1-2
NPN Inductive Sensor with Quick Disconnect*	25	OISN-014	1-2
PNP Inductive Sensor with Quick Disconnect*	25	OISP-014	1-2
NPN Inductive Sensor with Quick Disconnect*	90	OISN-013	1-2
PNP Inductive Sensor with Quick Disconnect*	90	OISP-013	1-2
NPN Magneto Resistive Sensor with Quick Disconnect*	90	OHSN-008	1-2
PNP Magneto Resistive Sensor with Quick Disconnect*	90	OHSP-008	1-2
NPN Magneto Resistive Sensor 90° with Quick Disconnect*	90	OHSN-011	1-2
PNP Magneto Resistive Sensor 90° with Quick Disconnect*	90	OHSP-011	1-2
Quick Disconnect 2 Meter Cable Length*	All Models	CABL-010	1-2
Quick Disconnect 5 Meter Cable Length*	All Models	CABL-013	1-2
Pneumatic Accessories	Model Numbers	Part Number	Qty/Unit
#10-32 to 1/4" OD Tube Flow Controls	90	VLVF-007	2
M5 to 6mm OD Tube Flow Controls	90	VLVF-008	2

\*Sensor and cable sold separately.



# RUA SERIES

## Angular Grippers

### How To Order

CLICK OR SCAN

To view full catalog pages on this product

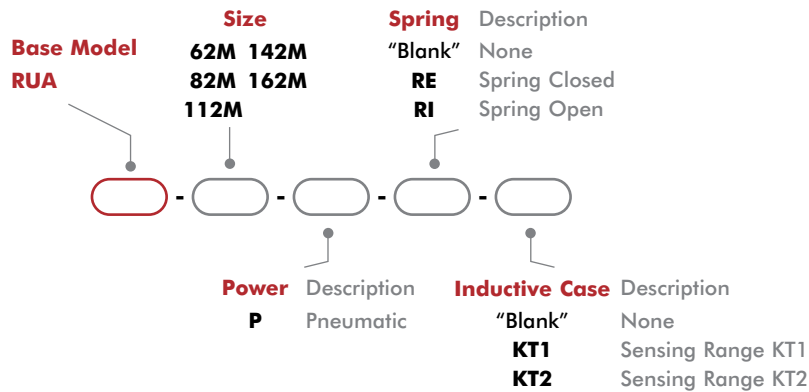

Size	Seal Repair Kits Viton®	Sealed Boots (2 interfaces, 1 collar, 1 boot)	
		PVC	Kevlar
62M	OSMK-156V	SLKT-367	SLKT-368
82M	OSMK-157V	SLKT-370	SLKT-371
112M	OSMK-158V	SLKT-373	--
142M	OSMK-333V	SLKT-376	--
162M	OSMK-335V	SLKT-379	--



**CLICK OR SCAN**  
To view full  
catalog pages  
on this product

# RUA SERIES

## Angular Grippers

### Basic Unit Dimensions

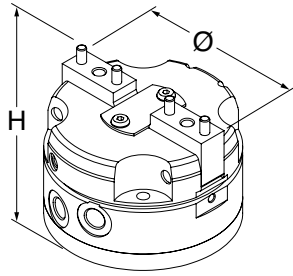

Size	Ø	H
62M	Ø60 [Ø2.36]	53 [2.09]
82M	Ø80 [Ø3.15]	57 [2.24]
112M	Ø110 [Ø4.33]	175 [6.89]
142M	Ø140 [Ø5.51]	107 [4.21]
162M	Ø165 [Ø6.50]	119 [4.69]

### Technical Data

Specifications	Units	62M	82M	112M
Total Rated Grip Force <b>L=25mm</b> [1 in.] @ 0°				
@ 7 bar [100 psi], w/spring	N [lbs]	384 [86]	1228 [276]	2150 [483]
@ 7 bar [100 psi], w/o spring	N [lbs]	313 [70]	922 [207]	1600 [360]
Total Stroke		16.8° per finger (33.6° total)	15.9° per finger (31.8° total)	19.1° per finger (38.2° total)
Weight	kg [lbs]	0.39 [0.86]	0.70 [1.55]	1.70 [3.75]
Pressure Range	bar [psi]	w/o springs 2-7 [30-100] /with springs <b>-RE, -RI</b> 3-7 [45-100]		
Displacement	cm <sup>3</sup> [in <sup>3</sup> ]	12 [0.73]	35 [2.14]	85 [5.19]
Temperature Range (Viton® seals standard)	°C [°F]	-30°~150° [-20°~300°]		
Actuation	sec	0.18	0.10	0.35

Specifications	Units	142M	162M
Total Rated Grip Force <b>L=25mm</b> [1 in.] @ 0°			
@ 7 bar [100 psi], w/spring	N [lbs]	5775 [1298]	5490 [1234]
@ 7 bar [100 psi], w/o spring	N [lbs]	3941 [886]	3790 [853]
Total Stroke		17.6° per finger (35.2° total)	17.2° per finger (34.4° total)
Weight	kg [lbs]	4.1 [9.05]	6.7 [14.8]
Pressure Range	bar [psi]	w/o springs 2-7 [30-100] /with springs <b>-RE, -RI</b> 3-7 [45-100]	
Displacement	cm <sup>3</sup> [in <sup>3</sup> ]	215 [13.2]	322 [19.7]
Temperature Range (Viton® seals standard)	°C [°F]	-30°~150° [-20°~300°]	
Actuation	sec	0.60	0.80

### Accessories

Sensor Accessories	Model Numbers	Part Number	Qty/Unit
NPN Magneto Resistive Sensor with Quick Disconnect* **	62M, 82M, 112M	OHSN-017	1-2
PNP Magneto Resistive Sensor with Quick Disconnect* **	62M, 82M, 112M	OHSP-017	1-2
NPN Magneto Resistive Sensor 90° with Quick Disconnect* **	62M, 82M, 112M	OHSN-011	1-2
PNP Magneto Resistive Sensor 90° with Quick Disconnect* **	62M, 82M, 112M	OHSP-011	1-2
Replacement PNP Double Inductive Sensor* †	All Models	KT15	1
Quick Disconnect 2 Meter Cable Length*	62M, 82M, 112M	CABL-010	1-2
Quick Disconnect 5 Meter Cable Length*	62M, 82M, 112M	CABL-013	1-2
Quick Disconnect 2 Meter Cable Length (for KT Inductive Sensor)*	All Models	CABL-014	1-2

\* Sensor and cable sold separately. \*\* Piston magnet standard. † Requires KT1 or KT2 sensor option.

# FUA SERIES

## Angular Food Grippers

### How To Order

CLICK OR SCAN

To view full catalog pages on this product



(USB key shown for scale)

**Base Model**  
**FUA-63M**

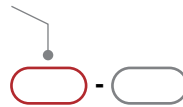

**Spring** Description  
"Blank" None  
**C** Spring Closed

### Technical Data

Specifications	Units	FUA-63M
Torque, Jaws @ 0° (mid-stroke)		
@ 6 bar [87 psi], w/spring	Nm [in-lbs]	32 [283]
@ 0 bar [0 psi], w/spring	Nm [in-lbs]	9 [80]
Total Stroke		70°
Weight (Stainless Steel)	kg [lbs]	1.7 [3.75]
Weight (Polymer)	kg [lbs]	0.8 [1.76]
Pressure Range without springs	bar [psi]	2-7 [30-100]
Pressure Range with springs	bar [psi]	3.5-7 [50-100]
Ingress Protection Class (IP)		IP69K
Displacement	cm <sup>3</sup> [in <sup>3</sup> ]	54 [3.30]
Temperature Range	°C [°F]	-15°~80° [5°~175°]

### Basic Unit Dimensions

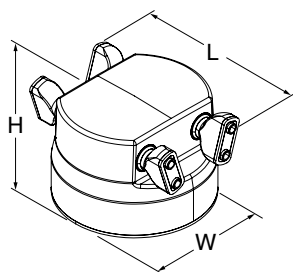

Size	L	W	H
FUA-63	100 [3.94]	90 [3.54]	62 [2.44]

# DRF SERIES

## Rotary Actuators

### How To Order

CLICK OR SCAN

To view full catalog pages on this product

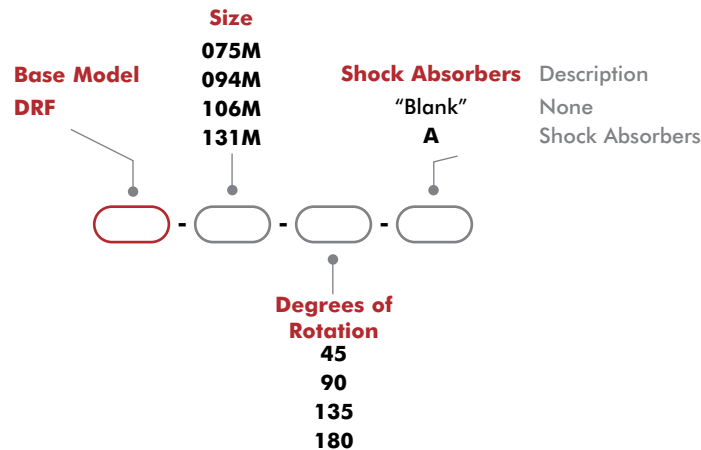

Size	Buna-N Seal Repair Kits		Turntables	
	Body	Shock	Blank	DIRECTCONNECT™
075M	SLKT-210	SLKT-214	ODRF-002	ODRF-004
094M	SLKT-216	SLKT-219	ODRF-008	ODRF-010
106M	SLKT-222	SLKT-225	ODRF-014	ODRF-016
131M	SLKT-228	SLKT-232	ODRF-020	ODRF-022

### Basic Unit Dimensions

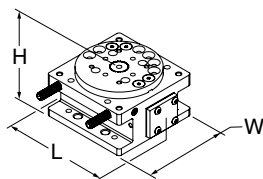

Size	L	W	H
075M	68 [2.69]	54 [2.13]	38.8 [1.52]
094M	85 [3.38]	71 [2.78]	44.8 [1.76]
106M	102 [4.54]	100 [3.94]	57.9 [2.28]
131M	153 [6.02]	133 [5.25]	71.7 [2.82]



**CLICK OR SCAN**  
To view full  
catalog pages  
on this product

# DRF SERIES

## Rotary Actuators

### Technical Data

Specifications	Units	075M	094M	106M	131M
Maximum Payload with Shocks (-A)	kg [lb]	0.45 [1.0]	1.4 [3.0]	3.6 [8.0]	6.8 [15]
Maximum Payload without Shocks	kg [lb]	0.23 [0.5]	0.68 [1.5]	1.8 [4.0]	3.4 [7.5]
Maximum Payload Inertia with Shocks (-A)	Nm sec <sup>2</sup> [in-lbs sec <sup>2</sup> ]	1.8 X 10 <sup>4</sup> [0.0016]	1.3 X 10 <sup>3</sup> [0.0111]	4.7 X 10 <sup>3</sup> [0.0414]	1.1 X 10 <sup>2</sup> [0.0970]
Maximum Payload Inertia without Shocks	Nm sec <sup>2</sup> [in-lbs sec <sup>2</sup> ]	9.0 X 10 <sup>5</sup> [0.0008]	6.3 X 10 <sup>4</sup> [0.0056]	2.3 X 10 <sup>3</sup> [0.0207]	5.5 X 10 <sup>3</sup> [0.0485]
Maximum Torque @ 7 bar [100psi]	Nm [lbs-in]	0.9 [8.3]	1.9 [17.3]	3.8 [33.2]	7.6 Nm [67.6]
Maximum Rotation		180°			
Pitch Diameter of Pinion	mm [in]	9.5 [0.375]	12.7 [0.500]	19.1 [0.750]	25.4 [1.000]
Weight with Shocks (-A)	kg [lb]	0.34 [0.72]	0.64 [1.4]	1.4 [3.1]	3.1 [6.8]
Weight without Shocks	kg [lb]	0.24 [0.54]	0.50 [1.1]	1.1 [2.5]	2.9 [6.3]
Pressure Range	bar [psi]	3-7 [40-100]			
Displacement 180°	cm <sup>3</sup> [in <sup>3</sup> ]	5.1 [0.31]	9.0 [0.55]	19.0 [1.16]	34.6 [2.11]
Actuation Time 180° @ 5,5 bar [80 psi]	sec	0.38		0.60	0.87
Actuation Time 90° @ 5,5 bar [80 psi]	sec	0.29		0.45	0.68
Over Travel (each end)		1°-3°			
Temperature Range with Shocks (-A)	°C [°F]	-0°~66° [-32°~150°]			
Temperature Range without Shocks	°C [°F]	-35°~82° [-30°~180°]			
End Stop Adjustability (each end)		23°			

### Accessories

Sensor Accessories	Model Numbers	Part Number	Qty/Unit
NPN Magneto Resistive Sensor with Quick Disconnect*	All Models	OHSN-017	1-2
PNP Magneto Resistive Sensor with Quick Disconnect*	All Models	OHSP-017	1-2
NPN Magneto Resistive Sensor 90° Barrel with Quick Disconnect*	All Models	OHSN-011	1-2
PNP Magneto Resistive Sensor 90° Barrel with Quick Disconnect*	All Models	OHSP-011	1-2
Quick Disconnect 2 Meter Cable Length*	All Models	CABL-010	1-2
Quick Disconnect 5 Meter Cable Length*	All Models	CABL-013	1-2

Pneumatic Accessories	Model Numbers	Part Number	Qty/Unit
Fitting Push-in Straight G1/8, 6mm O.D. Tube	131M	PLFT-038	1-2
Fitting Push-in Straight G1/8, 8mm O.D. Tube	131M	PLFT-045	1-2
Flow Control Push-in 90° Elbow M5-6mm O.D. Tube**	075M, 094M, 106M	VLVF-008	1-2
Flow Control Push-in 90° Elbow G1/8-6mm O.D. Tube**	131M	VLVF-005	1-2

\*Sensor and cable sold separately. \*\*Flow Controls recommended for most applications

# DRG SERIES

## Rotary Actuators

### How To Order

CLICK OR SCAN

To view full catalog pages on this product

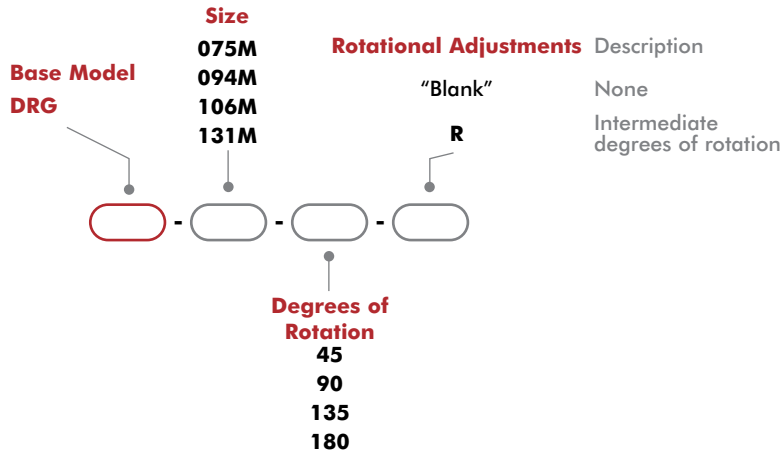
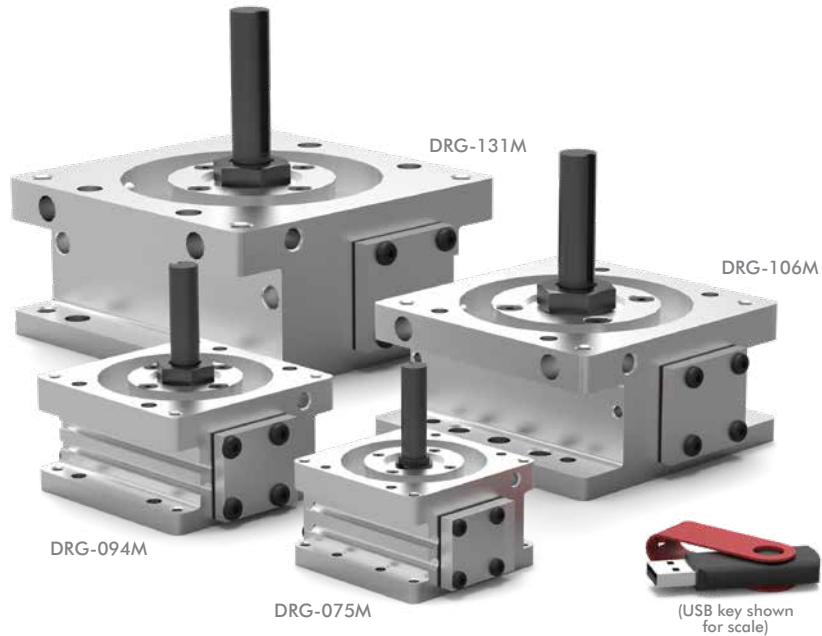

Size	Buna-N Seal Repair Kits	
	Body	Rotational Adjustment
075M	SLKT-210	SLKT-212
094M	SLKT-216	SLKT-218
106M	SLKT-222	SLKT-224
131M	SLKT-228	SLKT-230

### Basic Unit Dimensions

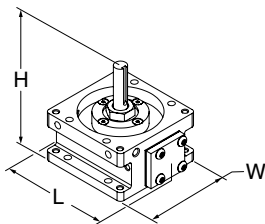

Size	L	W	H
075M	68 [2.69]	54 [2.13]	64 [2.51]
094M	85 [3.38]	71 [2.78]	76 [3.02]
106M	102 [4.54]	100 [3.94]	102 [4.01]
131M	153 [6.02]	133 [5.25]	128 [5.02]



**CLICK OR SCAN**  
To view full  
catalog pages  
on this product

# DRG SERIES

## Rotary Actuators

### Technical Data

Specifications	Units	075M	094M	106M	131M
Maximum Payload	kg [lb]	0.23 [0.5]	0.68 [1.5]	1.8 [4]	3.5 [7.5]
Maximum Payload Inertia	Nm sec <sup>2</sup> [in-lbs sec <sup>2</sup> ]	9.0 X 10 <sup>5</sup> [0.0008]	6.3 X 10 <sup>4</sup> [0.0056]	2.3 X 10 <sup>3</sup> [0.0207]	5.5 X 10 <sup>3</sup> [0.0485]
Maximum Torque @ 100psi/7 bar	Nm [lbs-in]	0.9 [0.83]	1.9 Nm [17.3]	3.8 [33.2]	7.6 [68]
Maximum Rotation		180°			
Pitch Diameter of Pinion	mm [in]	9.5 [0.375]	12.7 [0.500]	19.1 [0.750]	25.4 [1.000]
Weight with rotational adjuster (-R)	mm [in]	0.33 [0.72]	0.54 [1.2]	1.2 [2.7]	2.5 [5.6]
Weight without rotational adjuster	mm [in]	0.24 [0.52]	0.45 [1.0]	1.1 [2.5]	2.4 [5.4]
Pressure Range	bar [psi]	3-7 [40-100]			
Displacement 180°		5.1 [0.31]	9.0 [0.55]	19.0 [1.16]	34.6 [2.11]
Actuation Time 180° @ 5,5 bar [80 psi]	sec	0.38		0.60	0.87
Actuation Time 90° @ 5,5 bar [80 psi]	sec	0.29		0.45	0.68
Temperature Range	°C [°F]	-35°~82° [-30°~180°]			
End Stop Adjustability (-R)		23°			
Over Travel (each end)		1°-3°			

### Accessories

Sensor Accessories	Model Numbers	Part Number	Qty/Unit
NPN Magneto Resistive Sensor with Quick Disconnect*	All Models	OHSN-017	1-2
PNP Magneto Resistive Sensor with Quick Disconnect*	All Models	OHSP-017	1-2
NPN Magneto Resistive Sensor 90° Barrel with Quick Disconnect*	All Models	OHSN-011	1-2
PNP Magneto Resistive Sensor 90° Barrel with Quick Disconnect*	All Models	OHSP-011	1-2
Quick Disconnect 2 Meter Cable Length*	All Models	CABL-010	1-2
Quick Disconnect 5 Meter Cable Length*	All Models	CABL-013	1-2

Pneumatic Accessories	Model Numbers	Part Number	Qty/Unit
Fitting Push-in 90° Elbow G1/8, 6mm O.D. Tube	131M	PLFT-042	1-2
Fitting Push-in 90° Elbow G1/8, 8mm O.D. Tube	131M	PLFT-048	1-2
Fitting Push-in Straight G1/8, 6mm O.D. Tube	131M	PLFT-038	1-2
Fitting Push-in Straight G1/8, 8mm O.D. Tube	131M	PLFT-045	1-2
Flow Control Push-in 90° Elbow M5-6mm O.D. Tube**	075M, 094M, 106M	VLVF-008	1-2
Flow Control Push-in 90° Elbow G1/8-6mm O.D. Tube**	131M	VLVF-005	1-2

\*Sensor and cable sold separately. \*\*Flow Controls recommended for most applications

# RR LIGHT-DUTY SERIES

## Rotary Actuators

### How To Order

CLICK OR SCAN

To view full catalog pages on this product

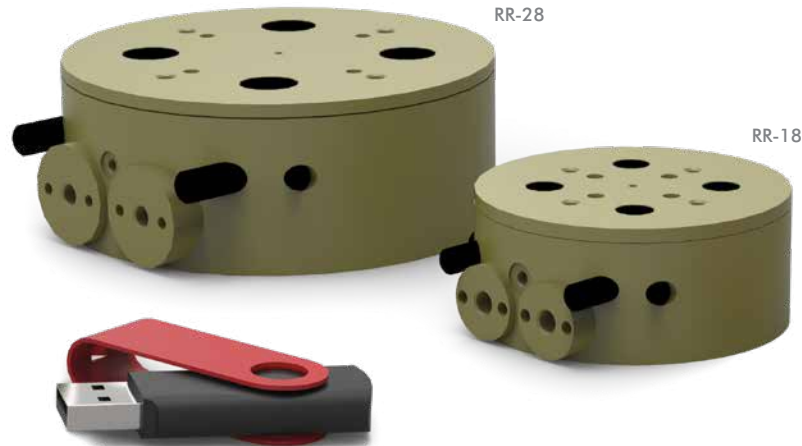

(USB key shown for scale)

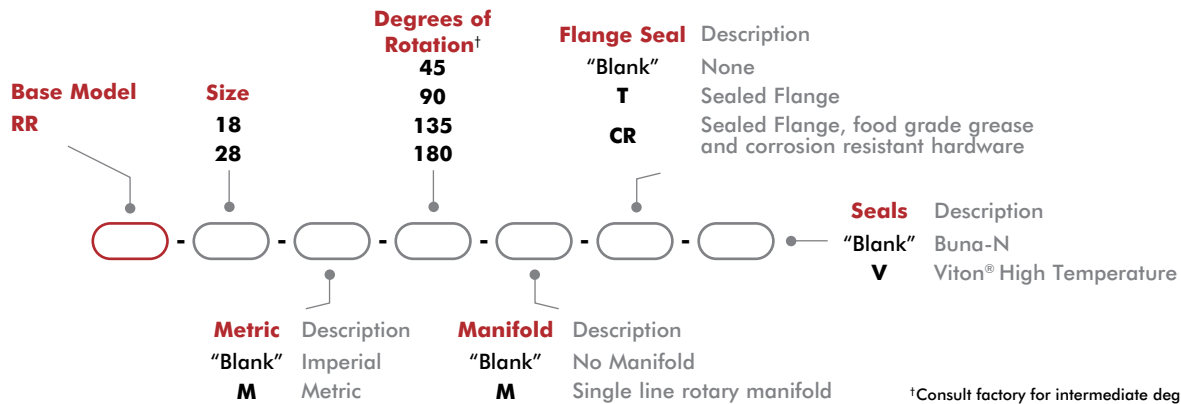

Size	Base Unit Seal Repair Kits		Bottom Air Port Manifold Seal Kit - Viton®
	Buna-N	Viton®	
18	SLKT-173	SLKT-173V	SLKT-174V
28	SLKT-175	SLKT-175V	SLKT-176V

### Basic Unit Dimensions

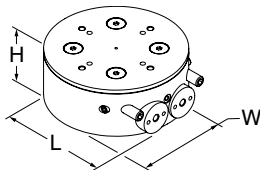

Size	L	W	H
18	170.9 [6.73]	101.6 [4.00]	43.7 [1.72]
28	203.2 [8.00]	113.5 [4.47]	54.1 [2.13]



**CLICK OR SCAN**

To view full catalog pages on this product

# RR LIGHT-DUTY SERIES

## Rotary Actuators

### Technical Data

Specifications	Units	18	28
Maximum Payload	kg [lb]	0.45 [1.0]	1.36 [3.0]
Maximum Payload Inertia	Nm sec <sup>2</sup> [in-lbs sec <sup>2</sup> ]	0.000181 [0.0016]	0.001255 [0.0111]
Maximum Rotation		180°	
Maximum Torque Mid-Stroke @ 7 bar [100psi]	Nm [lbs-in]	0.7 [6.5]	2.5 [22]
Maximum Torque End-Stroke @ 7 bar [100psi]			
Pitch Diameter of Pinion	mm [in]	8.46 [0.333]	12.7 [0.50]
Weight	kg [lb]	0.22 [0.48]	0.65 [1.44]
Pressure Range	bar [psi]	2-7 [30-100]	
Displacement 180°	cm <sup>3</sup> [in <sup>3</sup> ]	3.37 [0.205]	11.4 [0.69]
Temperature Range (Buna-N seals)	°C [°F]	-35°~80° [-30°~180°]	
Temperature Range (Viton® seals)	°C [°F]	-30°~150° [-20°~300°]	
Actuation Time 180° @ 5,5 bar [80 psi]	sec	0.30	0.35
Actuation Time 90° @ 5,5 bar [80 psi]	sec	0.25	0.30
Over Travel (each end)		4°	8°

### Accessories

Sensor Accessories	Model Numbers	Part Number	Qty/Unit
Sensor Mounting Kit (mounts 2 sensors)	All Models	OSMK-024	1
NPN Inductive Sensor with Quick Disconnect*	All Models	OISN-014	1-2
PNP Inductive Sensor with Quick Disconnect*	All Models	OISP-014	1-2
Quick Disconnect 2 Meter Cable Length*	All Models	CABL-010	1-2
Quick Disconnect 5 Meter Cable Length*	All Models	CABL-013	1-2
Pneumatic Accessories	Model Numbers	Part Number	Qty/Unit
M3 Plumbing Fitting Push-In for 3mm OD Tube	All Models	PLFT-021	2
M3 Plumbing Fitting Barb for 2mm ID Tube	All Models	PLFT-022	2
#10-32 Flow Control (Imperial)	All Models	VLVF-007	2
M5 Flow Control	All Models	VLVF-008	2

\*Sensor and cable sold separately.

# RR MEDIUM-DUTY SERIES

## Rotary Actuators

### How To Order

CLICK OR SCAN

To view full catalog pages on this product

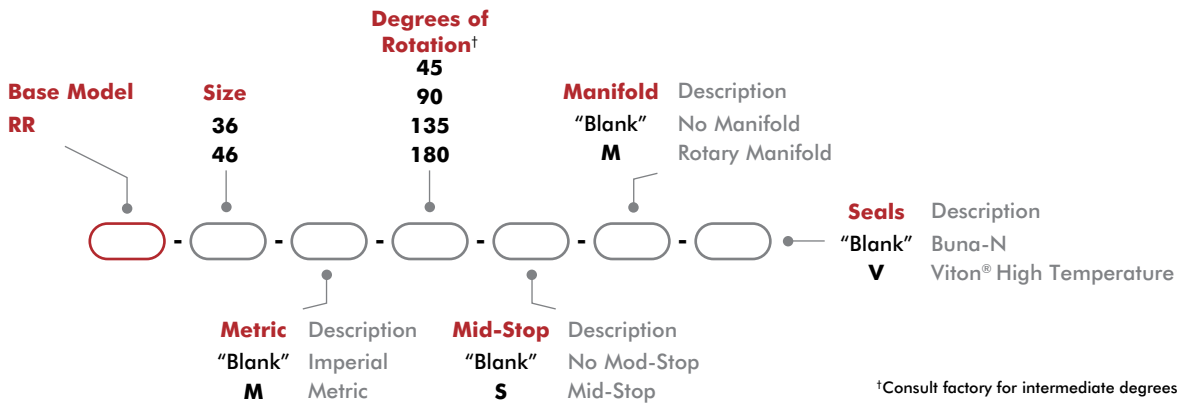

Size	Base Unit Seal Repair Kits		Manifold Seal Repair Kits		Mid-Stop Seal Repair Kits	
	Buna-N	Viton®	-M Buna-N	-M-V Viton®	-S Buna-N	-S-V Viton®
36	SLKT-016	SLKT-016V	SLKT-061	SLKT-061V	SLKT-062	SLKT-062V
46	SLKT-017	SLKT-017V	SLKT-067	SLKT-067V	SLKT-068	SLKT-068V

### Basic Unit Dimensions

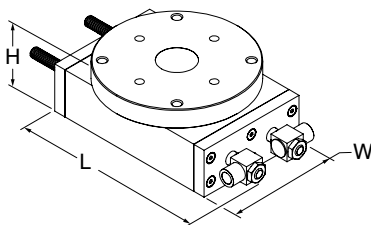

Size	L	W	H
36	170.9 [6.73]	101.6 [4.00]	43.7 [1.72]
46	203.2 [8.00]	113.5 [4.47]	54.1 [2.13]

**CLICK OR SCAN**

To view full catalog pages on this product

# RR MEDIUM-DUTY SERIES

## Rotary Actuators

### Technical Data

Specifications	Units	36	46
Maximum Payload	kg [lb]	3.6 [8.0]	6.8 [15]
Maximum Payload Inertia	Nm sec <sup>2</sup> [in-lbs sec <sup>2</sup> ]	0.00468 [0.0414]	0.01096 [0.0970]
Maximum Rotation		180°	
Maximum Torque Mid-Stroke @ 7 bar [100psi]	Nm [lbs-in]	7.4 [65]	14 [122]
Maximum Torque End-Stroke @ 7 bar [100psi]	Nm [lbs-in]	3.7 [32]	7 [61]
Weight (base unit)	kg [lb]	1.3 [2.9]	2.3 [5]
Weight Adder for Mid-Position Stop	kg [lb]	0.18 [0.4]	0.19 [0.42]
Weight Adder for Rotary Manifold	kg [lb]	0.04 [0.1]	0.17 [0.38]
Pressure Range	bar [psi]	3-7 [40-100]	
Ingress Protection Class (IP)		IP55	
Displacement 180°	cm <sup>3</sup> [in <sup>3</sup> ]	33.6 [2.05]	63.18 [3.855]
Displacement of Mid-Position Stop	cm <sup>3</sup> [in <sup>3</sup> ]	19.66 [1.200]	35.95 [2.194]
Temperature Range (Buna-N seals)	°C [°F]	-0°~66° [32°~150°]	
Temperature Range (Viton® seals)			
Actuation Time 180° @ 5,5 bar [80 psi]	sec	0.35	0.41
Actuation Time 90° @ 5,5 bar [80 psi]	sec	0.2	0.36
End-Stop Repeatability		±0.02°	
Mid-Stop Repeatability		±0.5°	
End-Stop Adjustability		60°	
Over Travel (each end)		4°	

### Accessories

Sensor Accessories	Model Numbers	Part Number	Qty/Unit
Sensor Mounting Kit (mounts 2 sensors)	All Models	OSMK-024	1
NPN Inductive Sensor with Quick Disconnect*	All Models	OISN-014	1-2
PNP Inductive Sensor with Quick Disconnect*	All Models	OISP-014	1-2
Quick Disconnect 2 Meter Cable Length*	All Models	CABL-010	1-2
Quick Disconnect 5 Meter Cable Length*	All Models	CABL-013	1-2

\* Sensor and cable sold separately.

# RR HEAVY-DUTY SERIES

## Rotary Actuators

CLICK OR SCAN

To view full catalog pages on this product



### How To Order

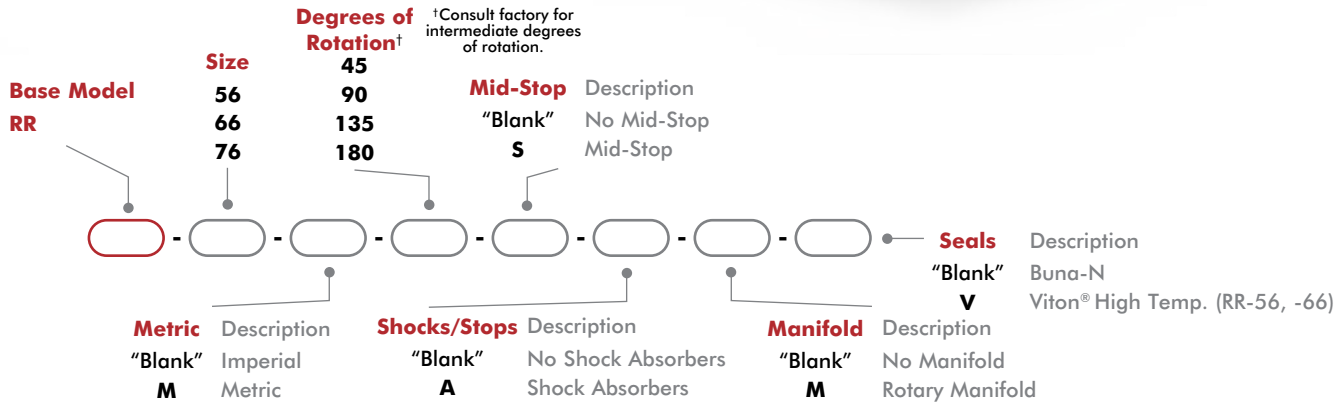

Size	Base Unit Seal Repair Kits		Manifold Seal Repair Kits		Mid-Stop Seal Repair Kits		Shock Seal Repair Kits	
	Buna-N	Viton®	-M Buna-N	-M-V Viton®	-S Buna-N	-S-V Viton®	-A Buna-N	-A-V Viton®
56	SLKT-124	SLKT-124V	SLKT-126	SLKT-126V	SLKT-127	SLKT-127V	SLKT-125	SLKT-125V
66	SLKT-128	SLKT-128V	SLKT-130	SLKT-130V	SLKT-131	SLKT-131V	SLKT-129	SLKT-129V
76	N/A	SLKT-167V	N/A	SLKT-169V	N/A	SLKT-168V	SLKT-179	N/A

### Basic Unit Dimensions

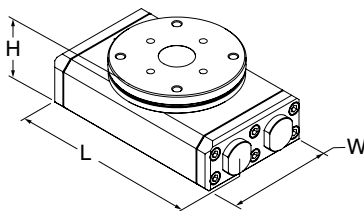

Size	L	W	H
56	[8.50] 215.9	117.5 [4.63]	70.2 [2.77]
66	[10.35] 262.8	158.8 [6.25]	96.8 [3.81]
76	[13.19] 334.9	222.3 [8.75]	136.5 [5.38]

**CLICK OR SCAN**To view full  
catalog pages  
on this product

# RR HEAVY-DUTY SERIES

## Rotary Actuators

### Technical Data

Specifications	Units	56	66	76
Maximum Payload <sup>†</sup>	kg [lb]	13.6 [30]	34 [75]	91 [200]
Maximum Payload Inertia <sup>†</sup>	Nm sec <sup>2</sup> [in-lbs sec <sup>2</sup> ]	0.02880 [0.2549]	0.11584 [1.0251]	0.5596 [4.95]
Maximum Rotation		180°		
Maximum Torque Mid-Stroke @ 7 bar [100psi]	Nm [lbs-in]	35 [311]	82 [728]	215 [1900]
Maximum Torque End-Stroke @ 7 bar [100psi]	Nm [lbs-in]	17 [155]	41 [364]	107 [950]
Weight (base unit)	kg [lb]	5.3 [11.6]	11.8 [26]	24 [53]
Weight Adder for Mid-Position Stop	kg [lb]	0.82 [1.8]	0.82 [1.8]	3.8 [8.3]
Weight Adder for Rotary Manifold	kg [lb]	0.54 [1.2]	0.36 [0.82]	2.0 [4.2]
Pressure Range	bar [psi]	3-7 [40-100]		
Displacement	cm <sup>3</sup> [in <sup>3</sup> ]	160.1 [9.77]	375 [22.8]	1026 [62.6]
Displacement of Mid-Position Stop	cm <sup>3</sup> [in <sup>3</sup> ]	90.16 [5.502]	60.32 [2.375]	885 [54]
Temperature Range (Buna-N seals)		0°~66° [-32°~150°]		
Temperature Range (Viton® seals)	°C [°F]	0°~66° [-32°~150°]		
Actuation Time 180° @ 5,5 bar [80 psi]	sec	0.48	0.70	1.4
Actuation Time 90° @ 5,5 bar [80 psi]	sec	0.40	0.50	0.8
End-Stop Adjustability*		30°	20°	
Over Travel (each end)		4°		

<sup>†</sup>Max. payload based on -A shock option.

\*Any adjustment of the End Stop Adjustment Screw must be accompanied by an equal adjustment of the Shock Absorbers to prevent bottoming of the pistons against the Shock Absorbers.

### Accessories

Sensor Accessories	Model Numbers	Part Number	Qty/Unit
Inductive Sensor Mounting Kit (mounts 2 sensors)	-56, -66	OSMK-075	1
Inductive Sensor Mounting Kit (mounts 2 sensors)	-76	OSMK-096	1
Magneto Resistive Sensor Mounting Kit (mounts 2 sensors)	-56, -66	OSMK-069	1
NPN Inductive Sensor with Quick Disconnect*	-56, -66	OISN-011	1-2
PNP Inductive Sensor with Quick Disconnect*	-56, -66	OISP-011	1-2
NPN Inductive Sensor with Quick Disconnect*	-76	OISN-017	1-2
PNP Inductive Sensor with Quick Disconnect*	-76	OISP-017	1-2
NPN Magneto Resistive Sensor with Quick Disconnect*	-56, -66	OHSN-017	1-2
PNP Magneto Resistive Sensor with Quick Disconnect*	-56, -66	OHSP-017	1-2
Quick Disconnect 2 Meter Cable Length*	-56, -66	CABL-010	1-2
Quick Disconnect 5 Meter Cable Length*	-56, -66	CABL-013	1-2
Quick Disconnect 2 Meter Cable Length*	-76	CABL-014	1-2
Quick Disconnect 5 Meter Cable Length*	-76	CABL-018	1-2

Pneumatic Accessories	Model Numbers	Part Number	Qty/Unit
1/4 NPT Flow Controls (Imperial)	-56	VLVF-009	2
G 1/4 BSPP Flow Controls	-56	VLVF-010	2
3/8 Flow Control (Imperial)	-66, -76	VLVF-011	2
G 3/8 BSPP Flow Control	-66, -76	VLVF-012	2
Adapter 1/8 NPT to G 1/8	-76	PLFT-028	1
Adapter 3/8 NPT to G 3/8	-76	PLFT-029	1

\*Sensor and cable sold separately.

# DLB SERIES - INTERNAL AIR CYLINDER

## Internal Air Cylinder Linear Base Slides

CLICK OR SCAN

To view full catalog pages on this product



### How To Order

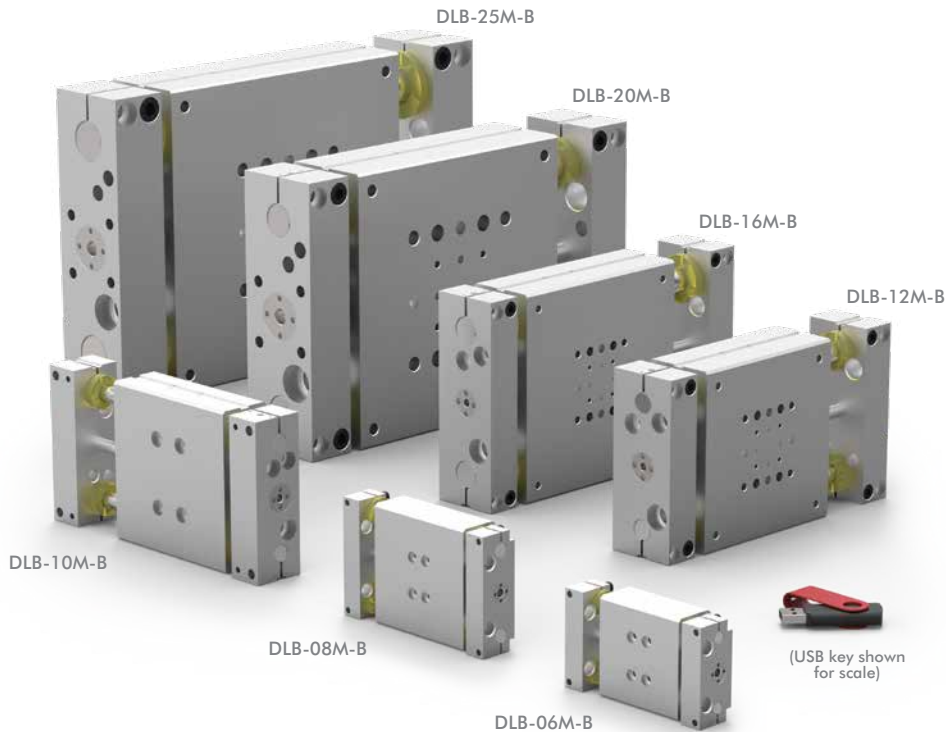

DLB-B series shown above

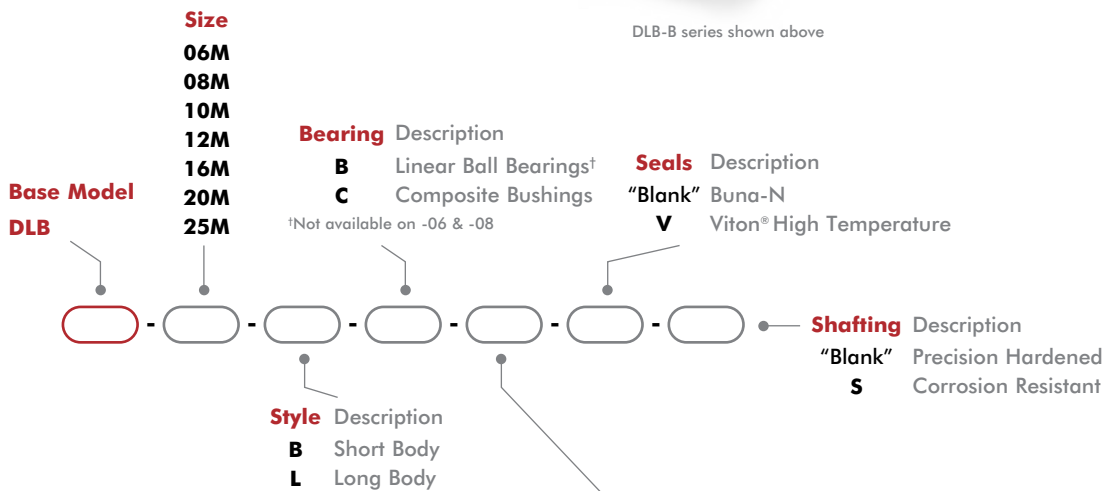

-B Style	Stroke* Metric (mm)
DLB-06M-B	6, 12, 25, 30
DLB-08M-B	6, 12, 25, 40, 44
DLB-10M-B	25, 50
DLB-12M-B	25, 50
DLB-16M-B	25, 50, 80
DLB-20M-B	25, 50, 80, 100
DLB-25M-B	25, 50, 80, 100, 125

-L Style	Stroke* Metric (mm)
DLB-06M-L	12, 25, 40, 50, 65, 75
DLB-08M-L	12, 25, 40, 50, 65, 75, 85
DLB-10M-L	25, 50, 80, 100
DLB-12M-L	25, 50, 80, 100, 125
DLB-16M-L	25, 50, 80, 100, 125, 150
DLB-20M-L	25, 50, 80, 100, 125, 160
DLB-25M-L	25, 50, 80, 100, 125, 160, 175

\*Custom strokes available. Consult factory.

\*Custom strokes available. Consult factory.



**CLICK OR SCAN**

To view full catalog pages on this product

# DLB SERIES - INTERNAL AIR CYLINDER

Internal Air Cylinder Linear Base Slides

## Basic Unit Dimensions

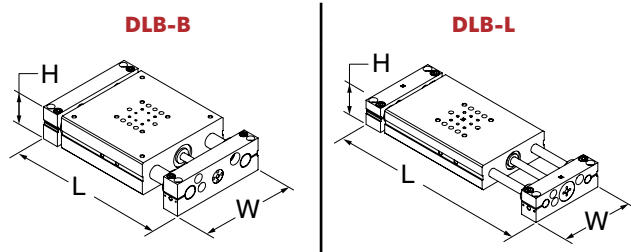

Size	Length - L		W	H
06	81 [3.19]	125.5 [4.94]	50.3 [1.98]	23.7 [0.93]
08	93.7 [3.69]	138.2 [5.44]	62.7 [2.47]	
10	143 [5.63]	193.8 [7.63]	88.6 [3.49]	31.6 [1.24]
12	155.7 [6.13]	219.2 [8.63]	101.2 [3.98]	42.1 [1.66]
16	174.8 [6.88]	244.6 [9.63]	120.3 [4.74]	
20	239.3 [9.42]	290.1 [11.42]	164.6 [6.48]	55.4 [2.18]
25	275.3 [10.84]	326.1 [12.84]	190 [7.48]	

## Technical Data

Specifications	Units	06-B, L	08-B, L	10-B, L	12-B, L
Max. Air Pressure	bar [psi]	7 [100]			
Thrust Force @ 5.5 bar [80psi]	N [lbs]	89 [20]		129 [29]	254 [57]
Weight (basic unit) <b>-B</b>	kg [lb]	0.20 [0.44]	0.36 [0.79]	0.93 [2.08]	1.7 [3.83]
Weight (basic unit) <b>-L</b>	kg [lb]	0.32 [0.71]	0.56 [1.24]	1.50 [3.34]	2.30 [5.13]
Additional Weight per Stroke <b>-B</b>	g/mm [lbs/in]	0.53 [0.03]	0.88 [0.05]	1.4 [0.08]	2.1 [0.12]
Cylinder Bore Ø	mm [in]	14.29 [0.563]		19 [0.75]	25 [1.00]
Shaft Ø	mm [in]	6 [0.236]	8 [0.315]	9.5 [0.375]	12 [0.472]

Specifications	Units	16-B, L	20-B, L	25-B, L
Max. Air Pressure	bar [psi]	7 [100]		
Thrust Force @ 5.5 bar [80psi]	N [lbs]	254 [57]	560 [126]	560 [126]
Weight (basic unit) <b>-B</b>	kg [lb]	2.4 [5.19]	5.9 [13.0]	8.2 [18.2]
Weight (basic unit) <b>-L</b>	kg [lb]	3.30 [7.30]	7.1 [15.6]	9.7 [21.4]
Additional Weight per Stroke <b>-B</b>	g/mm [lbs/in]	3.3 [0.19]	5.54 [0.32]	8.4 [0.47]
Cylinder Bore Ø	mm [in]	25 [1.00]	38 [1.5]	38 [1.5]
Shaft Ø	mm [in]	16 [0.630]	20 [0.787]	25 [0.984]

# DLB SERIES - INTERNAL AIR CYLINDER

CLICK OR SCAN

To view full  
catalog pages  
on this product



## Internal Air Cylinder Linear Base Slides

Shock/Stop Accessories	Model Numbers	Style	Part Number	Qty/Unit
Shock Absorber	06, 08	ALL	SHOK-030	1-2
	10		SHOK-028	
	12, 16,		SHOK-010	
	20, -25		SHOK-029	
Adjustable Hard Stop	06, 08	ALL	DLT-0623	1-2
	10, 12, 16, 20, 25		DLT-1023	
Sensor Accessories	Model Numbers	Style	Part Number	Qty/Unit
PNP Inductive Sensor with Quick Disconnect*	All Models	ALL	OISP-011	1-2
NPN Inductive Sensor with Quick Disconnect*			OISN-011	
Quick Disconnect 2 Meter Cable Length*			CABL-010	
Quick Disconnect 5 Meter Cable Length*			CABL-013	
Pneumatic Accessories	Model Numbers	Style	Part Number	Qty/Unit
G1/8 Telescopic Airlines (up to 50mm)	10, 12, 16	B	OTAL-043	1-4
G1/8 Telescopic Airlines (up to 80mm)	10, 12, 16	L	OTAL-044	
G1/8 Telescopic Airlines (up to 100mm)	10, 12, 16		OTAL-051	
G1/8 Telescopic Airlines (up to 125mm)	10, 12, 16	L	OTAL-052	
G1/8 Telescopic Airlines (up to 160mm)	10, 12, 16, 20, 25		OTAL-045	
G1/8 Telescopic Airlines (up to 300mm)	20, 25		OTAL-046	
M5 Adjustable Flow Control	06, 08, 10, 12, 16	ALL	VLVF-008	1-2
G 1/8 Adjustable Flow Control	20, 25		VLVF-005	
Cylinder Seal Kit (Buna-N)	06, 08	ALL	SLKT-109	1
	10		SLKT-101	
	12, 16		SLKT-103	
	20, 25		SLKT-105	
Cylinder Seal Kit (Viton®)	06, 08	ALL	SLKT-109V	1
	10		SLKT-101V	
	12, 16		SLKT-103V	
	20, 25		SLKT-105V	

\*Sensor and cable sold separately.





**CLICK OR SCAN**

To view full catalog pages on this product

# DLB SERIES - EXTERNAL AIR CYLINDER

External Air Cylinder Linear Base Slides

## How To Order

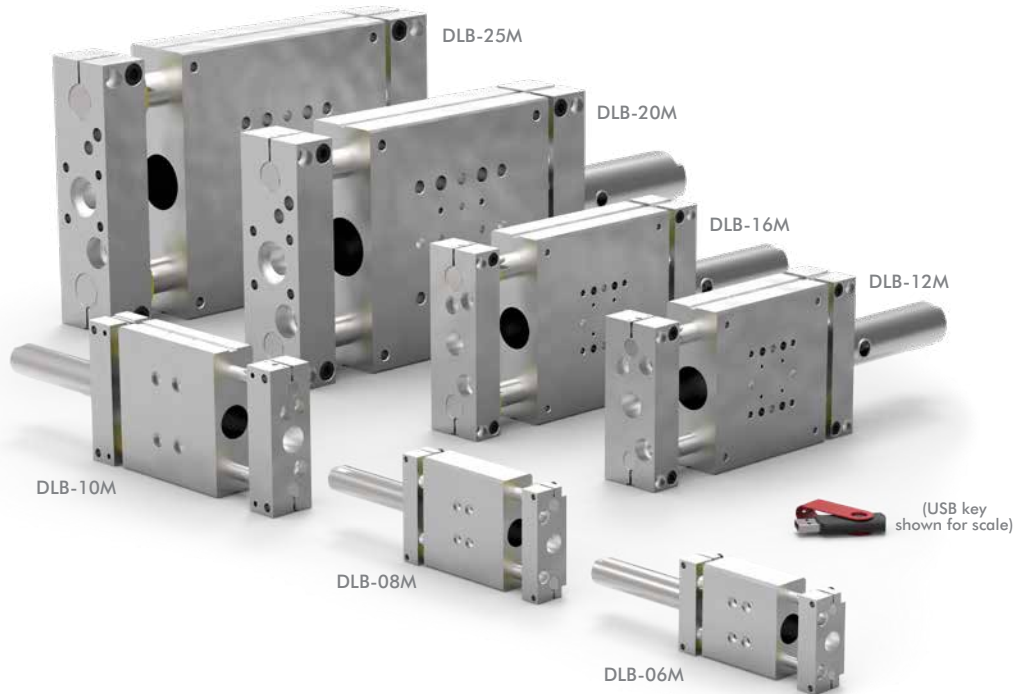

<b>Base Model</b> DLB	<b>Size</b>	<b>Styles Available</b>	<b>Style</b>	<b>Description</b>
	06M	T, U	<b>T</b>	Replaceable cylinder w/o adjustable air cushions
	08M	T, U	<b>A</b>	Replaceable cylinder with adjustable air cushions
	10M	A, U	<b>N</b>	Repairable VDMA cylinder w/adjustable air cushions
	12M	A, U	<b>R</b>	Repairable locking VDMA cylinder w/adjustable air cushions
	16M	A, U	<b>U</b>	Non-powered unit*
	20M	N, R, U	*Without cylinder. Metric Units: Mount VDMA cylinder directly.	
25M	N, R, U			

<b>Bearing</b>	<b>Description</b>	<b>Shafting</b>	<b>Description</b>
<b>B</b>	Linear Ball Bearings*	"Blank"	Precision Hardened
<b>C</b>	Composite Bushings	<b>S</b>	Corrosion Resistant
	*Not available on -06 or -08		

Size	Style	Stroke* Metric (mm)
DLB-06M	T, U	10, 25, 40, 50, 75, 100, 125, 160
DLB-08M	T, U	10, 25, 40, 50, 75, 100, 125, 160, 175, 200
DLB-10M	A, U	25, 50, 80, 100, 125, 160, 200, 250, 300
DLB-12M	A, U	25, 50, 80, 100, 125, 160, 200, 250, 300, 320, 360, 400
DLB-16M	A, U	25, 50, 80, 100, 125, 160, 200, 250, 300, 320, 360, 400, 500
DLB-20M	N, R, U	25, 50, 80, 100, 125, 160, 200, 250, 300, 320, 360, 400, 500
DLB-25M	N, R, U	25, 50, 80, 100, 125, 160, 200, 250, 300, 320, 360, 400, 500

\*Custom strokes available. Consult factory.

# DLB SERIES - EXTERNAL AIR CYLINDER

CLICK OR SCAN

To view full  
catalog pages  
on this product



## External Air Cylinder Linear Base Slides

### Basic Unit Dimensions

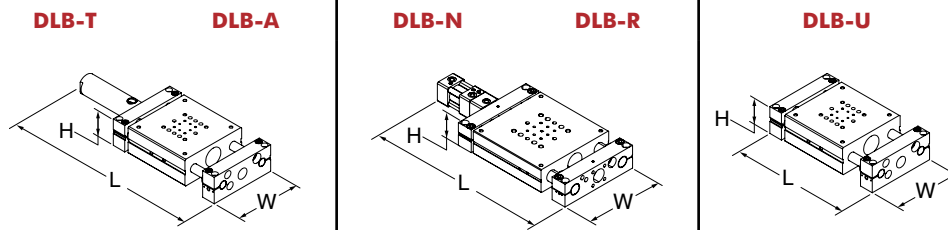

Size	Length - L				W	H
06	129.4 [5.09]	--	--	--	81.0 [3.19]	50.3 [1.98]
08	142.1 [5.59]	--	--	--	93.7 [3.69]	62.7 [2.47]
10	--	237.4 [9.35]	--	--	143 [5.63]	88.6 [3.49]
12	--	253.6 [9.98]	--	--	155.7 [6.13]	101.2 [3.98]
16	--	272.6 [10.73]	--	--	174.8 [6.88]	120.3 [4.74]
20	--	--	337.3 [13.28]	377.9 [14.88]	239.3 [9.42]	164.6 [6.48]
25	--	--	373.3 [14.70]	413.9 [16.30]	275.3 [10.84]	190 [7.48]

### Technical Data

Specifications	Units	06-T, U	08-T, U	10-A, U	12-A, U
Max. Air Pressure	bar [psi]	7 [100]			
Thrust Force @ 5.5 bar [80psi]	N [lbs]	89 [20]		145 [31]	289 [65]
Weight (basic unit)	kg [lb]	0.15 [0.34]	0.31 [0.69]	0.90 [1.98]	1.66 [3.73]
Additional Weight per Stroke	g/mm [lbs/in]	0.88 [0.05]	1.23 [0.07]	1.4 [0.09]	2.9 [0.16]
Cylinder Bore Ø	mm [in]	16 [0.563]		20 [0.75]	25 [1.00]
Shaft Ø	mm [in]	6 [0.236]	8 [0.315]	9.5 [0.375]	12 [0.472]
Maximum Moment Load	N-m [in-lbs]	1.7 [15]	3.4 [30]	8.4 [75]	16.9 [150]

Specifications	Units	16-A, U	20-A, N, R, U	25-A, N, R, U
Max. Air Pressure	bar [psi]	7 [100]		
Thrust Force @ 5.5 bar [80psi]	N [lbs]	289 [65]	578 [130]	578 [130]
Weight (basic unit)	kg [lb]	2.3 [5.03]	5.9 [12.9]	8.3 [18.0]
Additional Weight per Stroke	g/mm [lbs/in]	4.2 [0.23]	9.5 [0.53]	12.1 [0.68]
Cylinder Bore Ø	mm [in]	25 [1.00]	32 [1.25]	32 [1.25]
Shaft Ø	mm [in]	16 [0.630]	20 [0.787]	25 [0.984]
Maximum Moment Load	N-m [in-lbs]	33.9 [300]	67.8 [600]	135 [1200]
Min. Air Pressure to Release Cylinder Lock -R	bar [psi]		4 [60]	4 [60]
Holding Force of Locking Mechanism -R	N [lbs]		550 [123]	550 [123]

**CLICK OR SCAN**

To view full catalog pages on this product

# DLB SERIES - EXTERNAL AIR CYLINDER

## External Air Cylinder Linear Base Slides

Shock/Stop Accessories	Model Sizes	Style	Part Number	Qty/Unit
Shock Absorber	06, 08	All	SHOK-030	1-2
	10		SHOK-028	
	12, 16,		SHOK-010	
	20, 25		SHOK-029	
Adjustable Hard Stop	06, 08		DLT-0623	
	10, 12, 16, 20, 25	DLT-1023		

Sensor Accessories	Model Sizes	Style	Part Number	Qty/Unit
PNP Inductive Sensor with Quick Disconnect*	All Models	All	OISP-011	1-2
NPN Inductive Sensor with Quick Disconnect*			OISN-011	
PNP Magneto Resistive Sensor w/Qk Disconnect*	06, 08, 10, 12, 16	T, A	OHSP-005	
NPN Magneto Resistive Sensor w/Quick Disconnect*			OHSN-005	
PNP Magneto Resistive Sensor w/Qk Disconnect*	20, 25	N, R	OHSP-020	
Quick Disconnect 2 Meter Cable Length*	All Models	All	CABL-010	
Quick Disconnect 5 Meter Cable Length*			CABL-013	
Cable Extension Cord 1M Length*	All Models	All	CABL-015	
Cable Extension Cord 2M Length*			CABL-016	

Pneumatic Accessories	Model Sizes	Style	Part Number	Qty/Unit
G1/8 Telescopic Airlines (up to 160mm)	10, 12, 16	All	OTAL-045	1-4
G1/8 Telescopic Airlines (up to 300mm)	10, 12, 16		OTAL-046	
G1/8 Telescopic Airlines (up to 450mm)	10, 12, 16, 20, 25		OTAL-047	
G1/8 Telescopic Airlines (up to 600mm)	20M, 25M		OTAL-048	
G1/8 Adjustable Flow Control	10, 12, 16, 20, 25		VLVF-005	1-2
G1/8 Male to 1/8 NPT Adapter	20, 25	PLFT-025		

\* Sensor and cable sold separately.

# DLT SERIES - INTERNAL AIR CYLINDER

## Internal Air Cylinder Linear Thruster Slides

CLICK OR SCAN

To view full catalog pages on this product



### How To Order

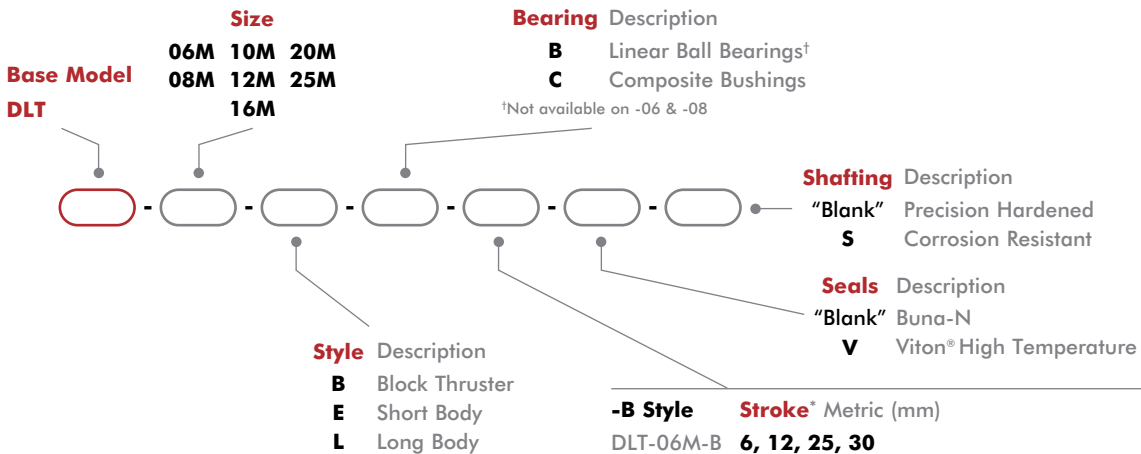
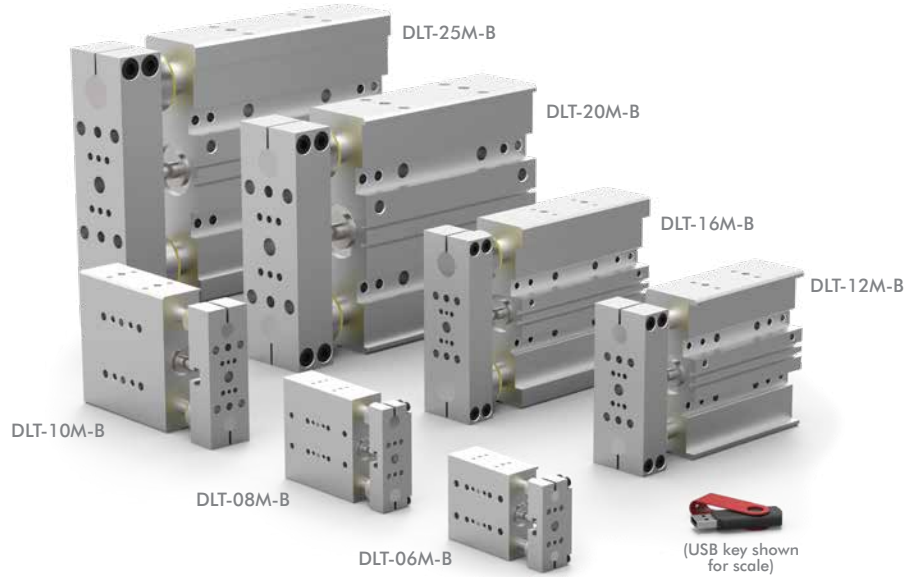

**-B Style Stroke\* Metric (mm)**

DLT-06M-B	6, 12, 25, 30
DLT-08M-B	6, 12, 25, 30, 40, 44
DLT-10M-B	12, 25, 40, 50
DLT-12M-B	12, 25, 40, 50
DLT-16M-B	12, 25, 40, 50, 65, 75
DLT-20M-B	12, 25, 40, 50, 65, 75, 85, 100
DLT-25M-B	12, 25, 40, 50, 65, 75, 85, 100, 115, 125

**-E Style Stroke\* Metric (mm)**

DLT-06M-E	6, 12, 25, 30
DLT-08M-E	6, 12, 25, 40, 44
DLT-10M-E	25, 50
DLT-12M-E	25, 50
DLT-16M-E	25, 50, 75
DLT-20M-E	25, 50, 75, 100
DLT-25M-E	25, 50, 75, 100, 125

**-L Style Stroke\* Metric (mm)**

DLT-06M-L	12, 25, 40, 50, 65, 75
DLT-08M-L	12, 25, 40, 50, 65, 75, 85
DLT-10M-L	25, 50, 80, 100
DLT-12M-L	25, 50, 80, 100, 125
DLT-16M-L	25, 50, 80, 100, 125, 150
DLT-20M-L	25, 50, 75, 100, 125, 160
DLT-25M-L	25, 50, 75, 100, 125, 160, 175

\*Custom strokes available. Consult factory.

Size	Base Flange Kit (-B Only)	Cylinder Seal Kits	
		Buna-N	Viton®
06	ODLT-015	SLKT-108	SLKT-108V
08	ODLT-016	SLKT-108	SLKT-108V
10	ODLT-006	SLKT-100	SLKT-100V
12	ODLT-008	SLKT-102	SLKT-102V
16	ODLT-010	SLKT-102	SLKT-102V
20	ODLT-012	SLKT-104	SLKT-104V
25	ODLT-014	SLKT-104	SLKT-104V



**CLICK OR SCAN**

To view full  
catalog pages  
on this product

# DLT SERIES - INTERNAL AIR CYLINDER

Internal Air Cylinder Linear Thruster Slides

## Basic Unit Dimensions

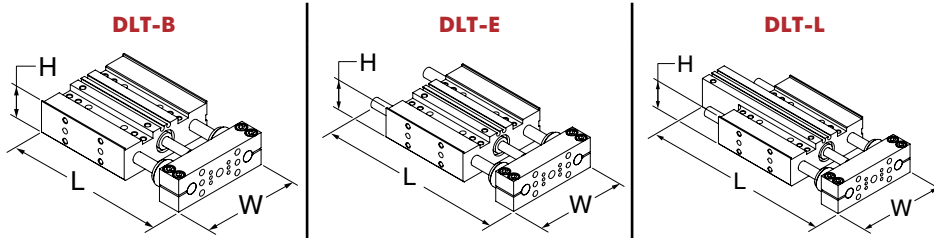

Size		Length - L	W	H
06	100,7 [3.96]	117,5 [4.63]	162,5 [6.40]	50,8 [2.00]
08	114,7 [4.52]	125,1 [4.93]	166,1 [6.54]	63,5 [2.50]
10	172,3 [6.78]	193,1 [7.60]	273,1 [10.75]	88,9 [3.50]
12	185 [7.28]	205,8 [8.10]	323,5 [12.74]	101,6 [4.00]
16	230,6 [9.08]	249,9 [9.84]	375,5 [14.78]	120,7 [4.75]
20	314,9 [12.40]	339,3 [13.36]	430,8 [16.96]	165,1 [6.50]
25	370,6 [14.59]	400,3 [15.76]	471,4 [18.56]	190,5 [7.50]

## Technical Data

Specifications	Units	06-B, E	06-L	08-B, E	08-L	10-B, E	10-L	12-B, E	12-L
Max. Air Pressure	bar [psi]	7 [100]							
Thrust Force @ 5.5 bar [80psi]	N [lbs]	89 [20]				155 [35]		275 [62]	
Weight -B (basic unit)	kg [lb]	0.15 [0.34]	--	0.30 [0.65]	--	0.82 [1.81]	--	1.31 [2.88]	--
Weight -E, L (basic unit)	kg [lb]		0.28 [0.61]		0.44 [0.96]	0.84 [1.87]	0.88 [1.95]	1.35 [2.98]	1.46 [3.21]
Cylinder Bore Ø	mm [in]	14.3 [0.563]				19 [0.75]		25 [1.0]	
Shaft Ø	mm [in]	6 [0.236]		8 [0.315]		9.5 [0.375]		12 [0.472]	
Max (M) Vertical Motion	Nm [in-lbs]	0.6 [5]		1.1 [10]		2.8 [25]		5.6 [50]	

Specifications	Units	16-B, E	16-L	20-B, E	20-L	25-B, E	25-L
Max. Air Pressure	bar [psi]	7 [100]					
Thrust Force @ 5.5 bar [80psi]	N [lbs]	275 [62]		622 [140]			
Weight -B (basic unit)	kg [lb]	1.99 [4.38]	--	5.1 [11.6]	--	7.2 [15.7]	--
Weight -E, L (basic unit)	kg [lb]	2.07 [4.56]	2.03 [4.81]	5.2 [11.6]	5.5 [12.0]	7.4 [16.4]	7.9 [17.4]
Cylinder Bore Ø	mm [in]	25 [1.0]		38 [1.5]			
Shaft Ø	mm [in]	16 [0.630]		20 [0.787]		25 [0.984]	
Max (M) Vertical Motion	Nm [in-lbs]	11.3 [100]		28.2 [250]		56.4 [500]	

# DLT SERIES - INTERNAL AIR CYLINDER

## Internal Air Cylinder Linear Thruster Slides

CLICK OR SCAN

To view full  
catalog pages  
on this product



### Accessories

Shock/Stop & Mounting Accessories	Model Numbers	Style	Part Number	Qty/Unit	
Universal Mounting Kit (Stop/Shock)	06	All	OSAK-069	1-2 on -B	
	08		OSAK-070		
Universal Mounting Kit (Stop/Shock/Sensor)	10		OSAK-055		
	12		OSAK-057		
	16		OSAK-059		
	20		OSAK-061		
	25		OSAK-063		
	06, 08		SHOK-030		
Shock Absorber	10		SHOK-028		1-4 on -E, -L
	12, 16,		SHOK-010		
	20, 25	SHOK-029			
Adjustable Hard Stop	06, 08	DLT-0623	1		
	10, 12, 16, 20, 25	DLT-1023			
Urethane Bumper/Stop Collar Kit	06	E, L	OSAK-067	1	
	08		OSAK-068		
	10		OSAK-065		
	12		OSAK-066		
	16		OSAK-060		
	20		OSAK-062		
	25	OSAK-064			

Sensor Accessories	Model Numbers	Style	Part Number	Qty/Unit	
Inductive Sensor Mounting Kit	06	All	OSMK-076	1 on -B	
	08		OSMK-077		
PNP Inductive Sensor with Quick Disconnect*	06, 08		OISP-014		
NPN Inductive Sensor with Quick Disconnect*			OISN-014		
PNP Inductive Sensor with Quick Disconnect*	10, 12, 16, 20, 25		OISP-011		1-2 on -E, -L
NPN Inductive Sensor with Quick Disconnect*			OISN-011		
PNP Magneto Resistive with Quick Disconnect*	All Models		OHSP-017		1-2
NPN Magneto Resistive with Quick Disconnect*			OHSN-017		
Quick Disconnect 2 Meter Cable Length*	All Models		CABL-010		
Quick Disconnect 5 Meter Cable Length*			CABL-013		

\* Sensor and cable sold separately.

Pneumatic Accessories	Model Numbers	Style	Part Number	Qty/Unit	
G1/8 Telescopic Airlines (up to 50mm)	10, 12, 16	B, E	OTAL-043	1-4	
G1/8 Telescopic Airlines (up to 80mm)		B, E, L	OTAL-044		
G1/8 Telescopic Airlines (up to 100mm)	20, 25	B, E	OTAL-051		
G1/8 Telescopic Airlines (up to 125mm)			OTAL-052		
G1/8 Telescopic Airlines (up to 160mm)	10, 12, 16	L	OTAL-045		
G1/8 Telescopic Airlines (up to 300mm)	20, 25		OTAL-046		
M5 Adjustable Flow Control	06, 08, 10, 12, 16	All	VLVF-008		1-2
G1/8 Adjustable Flow Control	20, 25		VLVF-005		



**CLICK OR SCAN**

To view full catalog pages on this product

# DLT SERIES - EXTERNAL AIR CYLINDER

External Air Cylinder Linear Thruster Slides

## How To Order

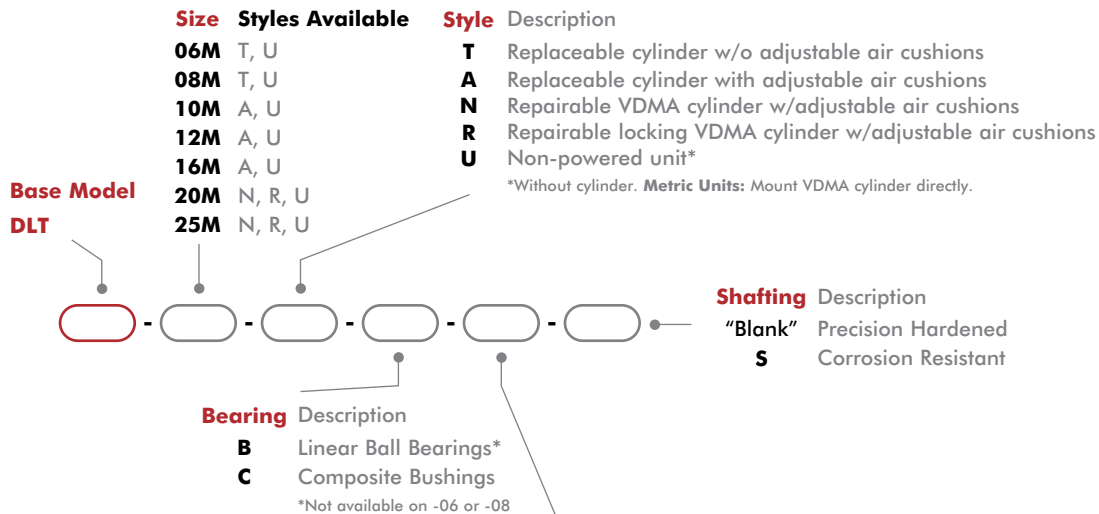
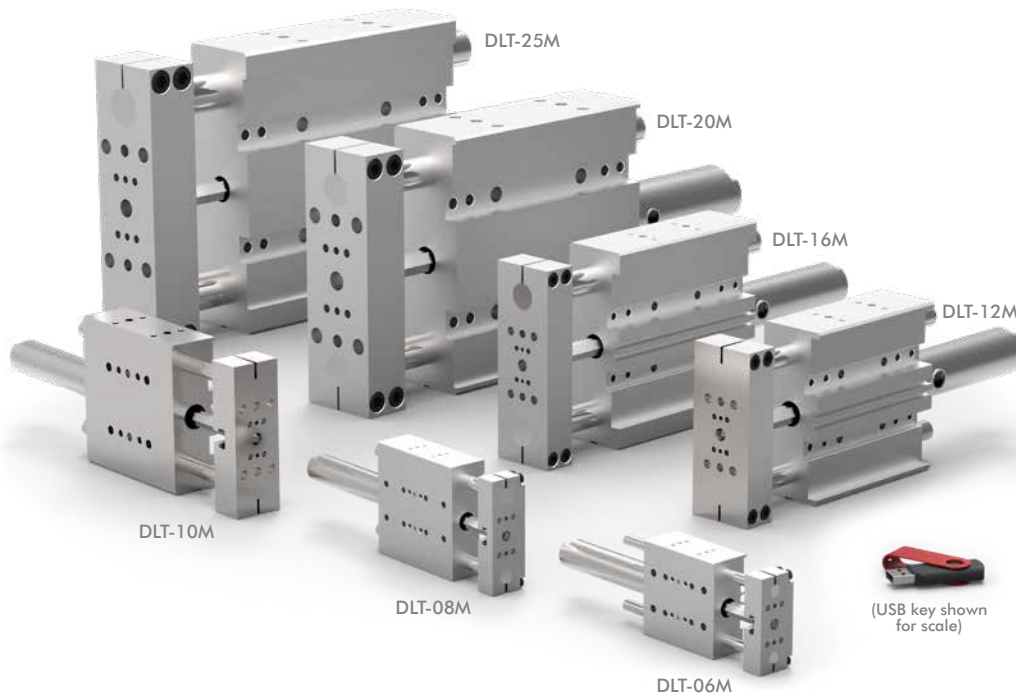

Size	Thrust Force @ 5.5 bar [80psi] N [lbs]
06-T, U	89 [20]
08-T, U	155 [35]
10-A, U	270 [70]
12-A, U	443 [140]
16-A, U	
20-N, R, U	
25-N, R, U	

Size	Style	Stroke* Metric (mm)
DLT-06M	T, U	10, 25, 40, 50, 75, 100, 125, 160
DLT-08M	T, U	10, 25, 40, 50, 75, 100, 125, 160, 175, 200
DLT-10M	A, U	25, 50, 80, 100, 125, 160, 200, 250, 300
DLT-12M	A, U	25, 50, 80, 100, 125, 160, 200, 250, 300, 320, 360, 400
DLT-16M	A, U	25, 50, 80, 100, 125, 160, 200, 250, 300, 320, 360, 400, 500
DLT-20M	N, R, U	25, 50, 80, 100, 125, 160, 200, 250, 300, 320, 360, 400, 500
DLT-25M	N, R, U	25, 50, 80, 100, 125, 160, 200, 250, 300, 320, 360, 400, 500

\*Custom strokes available. Consult factory.

# DLT SERIES - EXTERNAL AIR CYLINDER

CLICK OR SCAN

To view full  
catalog pages  
on this product



## External Air Cylinder Linear Thruster Slides

### Basic Unit Dimensions

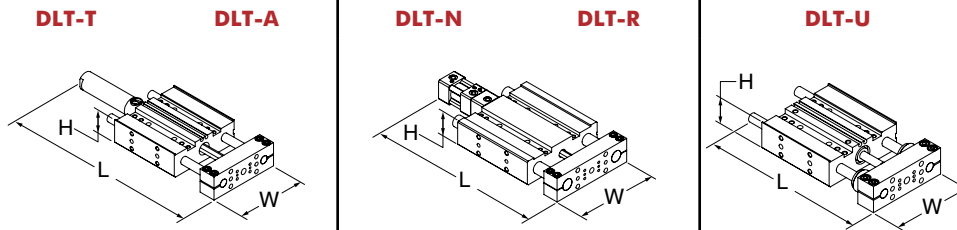

Size	Length - L				W	H
06	125.6 [4.94]	--	--	--	87.5 [3.44]	50.8 [2.00]
08	138.3 [5.44]	--	--	--	93.8 [3.69]	63.5 [2.50]
10	--	210.3 [8.28]	--	--	143.1 [5.63]	88.9 [3.50]
12	--	226.5 [8.92]	--	--	155.8 [6.13]	101.6 [4.00]
16	--	247.1 [9.73]	--	--	174.9 [6.89]	120.7 [4.75]
20	--	--	322.6 [12.70]	363.2 [14.30]	239.3 [9.42]	165.1 [6.50]
25	--	--	353.3 [13.91]	393.9 [15.51]	275.3 [10.84]	190.5 [7.50]

### Technical Data

Specifications	Units	06	08	10	12	16	20	25
Max. Air Pressure	bar [psi]	7 [100]						
Thrust Force @ 5.5 bar [80psi]	N [lbs]	111 [20]	89 [20]	173 [35]	270 [70]	270 [70]	443 [140]	443 [140]
Weight (basic unit)	kg [lb]	0.24 [0.53]	0.40 [0.88]	1.05 [2.12]	1.64 [3.42]	2.11 [4.47]	6.3 [14.3]	8.5 [19.2]
Additional Weight per Stroke	g/mm [lbs/in]	0.88 [0.05]	1.43 [0.07]	1.2 [0.09]	2.9 [0.15]	4.2 [0.23]	7.9 [0.53]	10.7 [0.68]
Cylinder Bore Ø	mm [in]	16 [0.563]		20 [0.787]	25 [0.984]		32 [1.26]	
Shaft Ø	mm [in]	6 [0.236]	8 [0.315]	9.5 [0.375]	12 [0.472]	16 [0.630]	20 [0.787]	25 [0.984]
Max (M) Vertical Motion	Nm [in-lbs]	0.6 [5]	1.3 [10]	--	--	--	--	--
Min. Air Pressure to Release Cyl. Lock -R	bar [psi]	--	--	--	--	--	4 [60]	
Holding Force of Lock Mechanism -R	N [lbs]	--	--	--	--	--	550 [123]	





**CLICK OR SCAN**

To view full catalog pages on this product

# DLT SERIES - EXTERNAL AIR CYLINDER

## External Air Cylinder Linear Thruster Slides

Shock/Stop & Mounting Accessories	Model Numbers	Style	Part Number	Qty/Unit
Universal Mounting Kit (Stop/Shock)	06	All	OSAK-069	1-4
	08		OSAK-070	
Universal Mounting Kit (Stop/Shock/Sensor)	10		OSAK-055	
	12		OSAK-057	
	16		OSAK-059	
	20		OSAK-061	
	25		OSAK-063	
	06, 08		SHOK-030	
Shock Absorber (2 Max on -06)	10		SHOK-028	
	12, 16,		SHOK-010	
	20, 25		SHOK-029	
	06, 08		DLT-0623	
Adjustable Hard Stop	10, 12, 16, 20, 25		DLT-1023	
	06		OSAK-067	
08	OSAK-068			
Urethane Bumper/Stop Collar Kit	10		OSAK-065	
	12	OSAK-066		
	16	OSAK-060		
	20	OSAK-062		
	25	OSAK-064		

Sensor Accessories	Model Numbers	Style	Part Number	Qty/Unit
Inductive Sensor Mounting Kit	06	T	OSMK-076	1
Inductive Sensor Mounting Kit	08		OSMK-077	
PNP Inductive Sensor with Quick Disconnect*	06, 08,	T	OISP-014	
NPN Inductive Sensor with Quick Disconnect*			OISN-014	
PNP Inductive Sensor with Quick Disconnect*	10, 12, 16, 20, 25	A, N, R	OISP-011	1-2
NPN Inductive Sensor with Quick Disconnect*			OISN-011	
PNP Magneto Resistive Sensor w/Qk Disconnect*	06, 08, 10, 12, 16	T, A	OHSP-005	
NPN Magneto Resistive Sensor w/Qk Disconnect*			OHSN-005	
PNP Magneto Resistive Sensor w/Qk Disconnect*	20, 25	N, R	OHSP-020	
Quick Disconnect 2 Meter Cable Length*	All Model	All	CABL-010	
Quick Disconnect 5 Meter Cable Length*			CABL-013	
Cable Extension Cord 1M Length*	All Models	All	CABL-015	
Cable Extension Cord 2M Length*			CABL-016	

Pneumatic Accessories	Model Numbers	Style	Part Number	Qty/Unit
VDMA Cylinder Mounting Kit	20, 25	U	ODLT-004	1
G1/8 Telescopic Airlines (up to 160mm)	10, 12, 16, 20, 25	All	OTAL-045	1-4
G1/8 Telescopic Airlines (up to 300mm)			OTAL-046	
G1/8 Telescopic Airlines (up to 450mm)			OTAL-047	
G1/8 Telescopic Airlines (up to 600mm)			OTAL-048	
M5 Adjustable Flow Control			06, 08	VLVF-008
G1/8 Adjustable Flow Control	10, 12, 16, 20, 25	VLVF-005		

\* Sensor and cable sold separately.

# DLM SERIES

## Miniature Rail Thruster Slide

### How To Order

CLICK OR SCAN

To view full catalog pages on this product

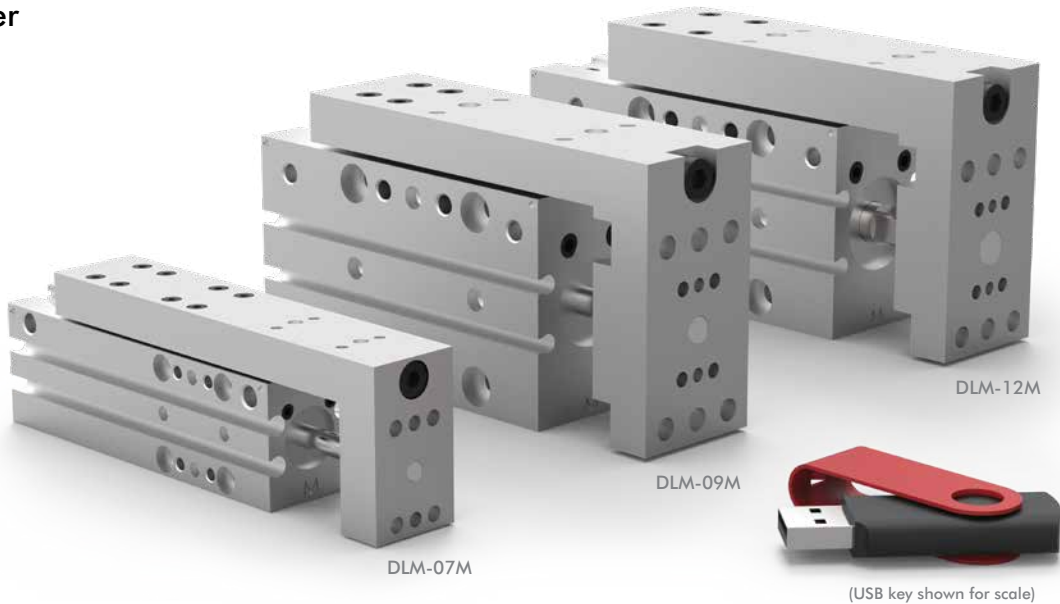

**Base Model DLM**

**Bearings** Description  
 "Blank" Single Bearings  
**D** Double Bearings\*  
\*Not available on DLM-07-12, 09-25, 12-25

**Stops** Description  
 "Blank" None  
**P** Precision Stops

Bore Size	Body Size	Stroke Metric (mm)
07M	12	5, 10, 12
	25	12, 15, 20, 25
	38	25, 30, 35, 38
	50	38, 40, 45, 50
09M or 12M	25	5, 10, 15, 20, 25
	50	25, 30, 35, 40, 45, 50
	75	50, 55, 60, 65, 70, 75
	100	75, 80, 85, 90, 95, 100

Size	Seal Repair Kits	
	Base Buna-N	Manifold Kit
07M	SLKT-236	SLKT-239
09M	SLKT-237	SLKT-240
09M	SLKT-238	

### Basic Unit Dimensions

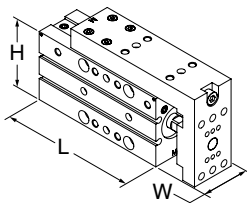

Size	L	W	H
07M-12	78 [3.07]	21 [0.83]	35.5 [1.40]
07M-25	102 [4.02]	21 [0.83]	35.5 [1.40]
07M-38	115 [4.53]	21 [0.83]	35.5 [1.40]
07M-50	127 [5.00]	21 [0.83]	35.5 [1.40]
09M-25	113 [4.45]	32 [1.26]	62 [2.44]
09M-50	159 [6.26]	32 [1.26]	62 [2.44]
09M-75	184 [7.24]	32 [1.26]	62 [2.44]
09M-100	209 [8.23]	32 [1.26]	62 [2.44]
12M-50	126 [4.96]	32 [1.26]	65 [2.56]
12M-75	166 [6.54]	32 [1.26]	65 [2.56]
12M-50	193 [7.60]	32 [1.26]	65 [2.56]
12M-100	218 [8.58]	32 [1.26]	65 [2.56]

**CLICK OR SCAN**

To view full catalog pages on this product

# DLM SERIES

## Miniature Rail Thruster Slide

### Technical Data

Specifications	Units	DLM-07M-12	DLM-07M-25	DLM-07M-38	DLM-07M-50
Thrust Force <b>F</b> @ 7 bar [100 psi]	N [lbs]	66 [15]			
Max. Stroke	mm [in]	12 [0.50]	25 [1.00]	38 [1.50]	50 [2.00]
Stroke Reduction (return)	mm [in]	5 [0.19]			
Weight	kg [lbs]	0.13 [0.28]	0.16 [0.35]	0.20 [0.43]	0.23 [0.50]
Max. Payload <b>W</b>	kg [lbs]	0.45 [1.0]			
Max. Payload <b>W</b> (-P option)	kg [lbs]	0.23 [0.5]			
Cylinder Bore $\emptyset$	mm [in]	0.11 [0.437]			
Actuation (per 25mm of travel)	sec	0.07			

Specifications	Units	DLM-09M-25	DLM-09M-50	DLM-09M-75	DLM-09M-100
Thrust Force <b>F</b> @ 7 bar [100 psi]	N [lbs]	138 N [31 lbs]			
Max. Stroke	mm [in]	25 [1.00]	50 [2.00]	75 [3.00]	100 [4.00]
Stroke Reduction (return)	mm [in]	5 [0.19]			
Weight	kg [lbs]	0.49 [1.08]	0.64 [1.41]	0.81 [1.78]	0.97 [2.13]
Max. Payload <b>W</b>	kg [lbs]	0.90 [2.0]			
Max. Payload <b>W</b> (-P option)	kg [lbs]	0.45 [1.0]			
Cylinder Bore $\emptyset$	mm [in]	16 [0.630]			
Actuation (per 25mm of travel)	sec	0.10			

Specifications	Units	DLM-12M-25	DLM-12M-50	DLM-12M-75	DLM-12M-100
Thrust Force <b>F</b> @ 7 bar [100 psi]	N [lbs]	230 [51]			
Max. Stroke	mm [in]	25 [1.00]	50 [2.00]	75 [3.00]	100 [4.00]
Stroke Reduction (return)	mm [in]	5 [0.19]			
Weight	kg [lbs]	0.54 [1.18]	0.65 [1.43]	1.82 [1.80]	1.02 [2.25]
Max. Payload <b>W</b>	kg [lbs]	1.81 [4.0]			
Max. Payload <b>W</b> (-P option)	kg [lbs]	0.90 [2.0]			
Cylinder Bore $\emptyset$	mm [in]	22 [0.813]			
Actuation (per 25mm of travel)	sec	0.14			

General Specifications	Units	
Temperature Range	°C [°F]	-35°~80° [-30°~180°]
Pressure Range	bar [psi]	1.4-7 [20-100]

### Accessories

Sensor Accessories	Model Numbers	Part Number	Qty/Unit
PNP Magneto Resistive Sensor Short Barrel (with Qk. Disc.)*	All Models	OHSP-017	1-4
NPN Magneto Resistive Sensor Short Barrel (with Qk. Disc.)*	All Models	OHSN-017	1-4
PNP Magneto Resistive Sensor 90° Barrel (with Qk. Disc.)*	All Models	OHSP-011	1-4
NPN Magneto Resistive Sensor 90° Barrel (with Qk. Disc.)*	All Models	OHSN-011	1-4
Quick Disconnect 2 Meter Cable Length*	All Models	CABL-010	1-4
Quick Disconnect 5 Meter Cable Length*	All Models	CABL-013	1-4

Pneumatic Accessories	Model Numbers	Part Number	Qty/Unit
Adjustable Flow Control	All Models	VLFL-008	1-2

\*Sensor and cable sold separately.

Dimensions and technical information are subject to change without notice

# MPS SERIES

## Miniature Rail Thruster Slide

### How To Order

CLICK OR SCAN

To view full catalog pages on this product

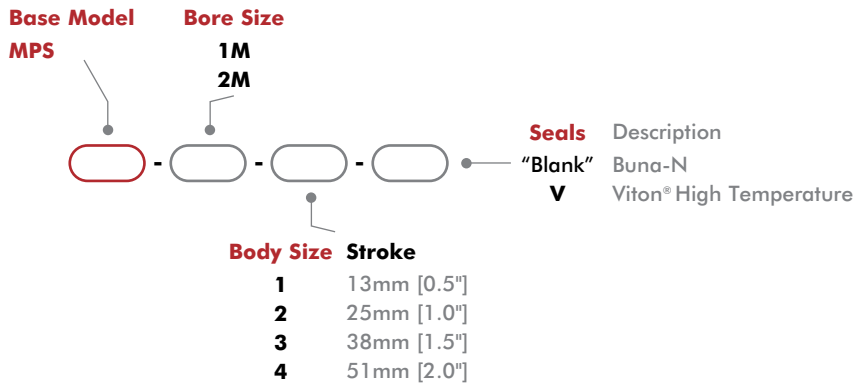
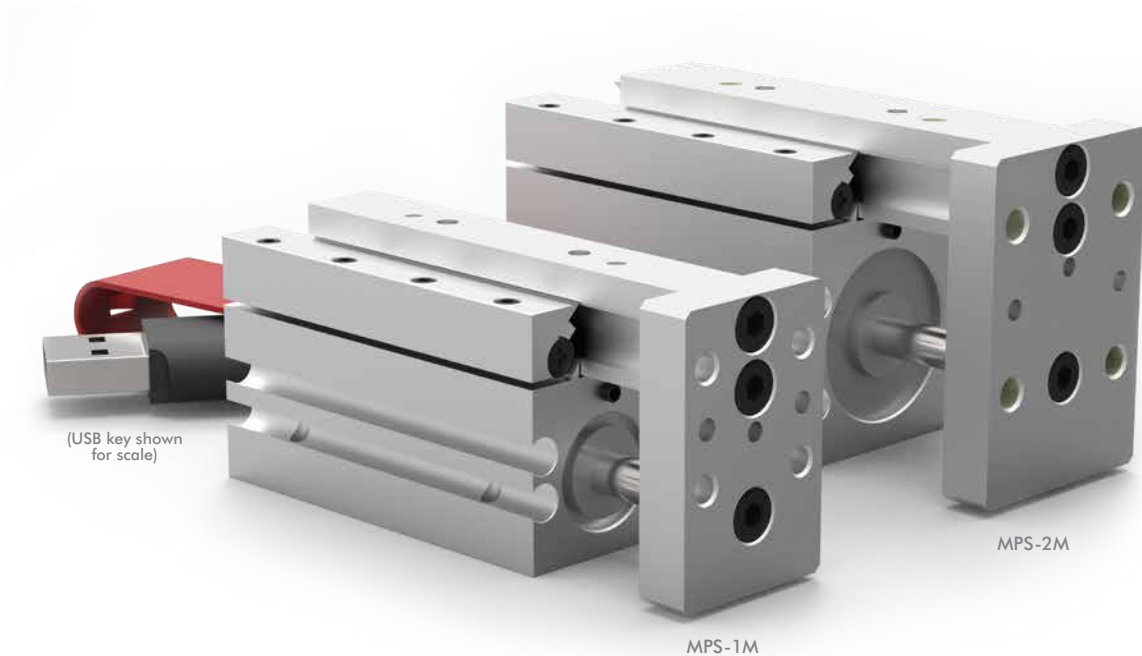

### Basic Unit Dimensions

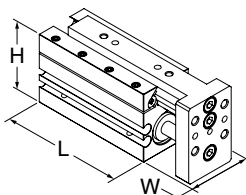

Size	L	W	H
1M-1	46 [1.81]	20.6 [0.81]	31.8 [1.25]
1M-2	63.4 [2.50]	20.6 [0.81]	31.8 [1.25]
1M-3	88.9 [3.50]	20.6 [0.81]	31.8 [1.25]
1M-4	113 [4.45]	20.6 [0.81]	31.8 [1.25]
2M-1	46 [1.81]	27 [1.06]	39.7 [1.56]
2M-2	64.4 [2.54]	27 [1.06]	39.7 [1.56]
2M-3	88.9 [3.50]	27 [1.06]	39.7 [1.56]
2M-4	113 [4.45]	27 [1.06]	39.7 [1.56]

**CLICK OR SCAN**

To view full catalog pages on this product

# MPS SERIES

## Miniature Rail Thruster Slide

### Technical Data

Specifications	Units	1M-1	1M-2	1M-3	1M-4
Thrust Force <b>F</b> @ 7 bar [100 psi]	N [lbs]	67 [15]			
Max. Stroke	mm [in]	13 [0.50]	25 [1.00]	38 [1.50]	51 [2.00]
Stroke Adjustability (each end)	mm [in]	3 [0.12]		6 [0.25]	
Weight	kg [lb]	0.08 [0.18]	0.10 [0.22]	0.13 [0.28]	0.14 [0.32]
Max. Payload <b>W</b>	kg [lb]	0.14 [0.30]	0.32 [0.70]	0.45 [1.00]	0.59 [1.30]
Pressure Range	bar [psi]	1.5-7 [20-100]			
Cylinder Bore $\varnothing$	mm [in]	11.1 [0.438]			
Temperature Range (Buna-N seals)	°C [°F]	-35°~80° [-30°~180°]			
Temperature Range (Viton® seals)	°C [°F]	-30°~120° [-20°~250°]			
Actuation	sec	0.10	0.11	0.13	0.14
Linear Accuracy (per 25mm of travel)	mm [in]	±0.003 [±0.0001]			

Specifications	Units	2M-1	2M-2	2M-3	2M-4
Thrust Force <b>F</b> @ 7 bar [100 psi]	N [lbs]	196 [44]			
Max. Stroke	mm [in]	13 [0.50]	25 [1.00]	38 [1.50]	51 [2.00]
Stroke Adjustability (each end)	mm [in]	3 [0.12]		6 [0.25]	
Weight	kg [lb]	0.12 [0.26]	0.14 [0.32]	0.18 [0.40]	0.21 [0.46]
Max. Payload <b>W</b>	kg [lb]	0.23 [0.50]	0.45 [1.00]	0.91 [2.00]	1.36 [3.00]
Pressure Range	bar [psi]	1.5-7 [20-100]			
Cylinder Bore $\varnothing$	mm [in]	19.1 [0.750]			
Temperature Range (Buna-N seals)	°C [°F]	-35°~80° [-30°~180°]			
Temperature Range (Viton® seals)	°C [°F]	-30°~120° [-20°~250°]			
Actuation	sec	0.12	0.16	0.19	0.24
Linear Accuracy (per 25mm of travel)	mm [in]	±0.003 [±0.0001]			

### Accessories

Sensor Accessories	Model Numbers	Part Number	Qty/Unit
Magneto Resistive Sensor with Quick. Disconnect*	All Models	OHSN-006	1-2
Magneto Resistive Sensor with Quick. Disconnect*		OHSP-006	
Quick Disconnect 2 Meter Cable Length*		CABL-010	
Quick Disconnect 5 Meter Cable Length*		CABL-013	

Pneumatic Accessories	Model Numbers	Part Number	Qty/Unit
M5 Adjustable Flow Control	All Models	VLVF-008	1-2
M2.5 Barbed Fitting		PLFT-005	2
Seal Kit (Buna-N)	-1M	SLKT-090	1
Seal Kit (Viton®)	-1M	SLKT-090V	
Seal Kit (Buna-N)	-2M	SLKT-091	
Seal Kit (Viton®)	-2M	SLKT-091V	

\*Sensor and cable sold separately.

# RFE SERIES

## Feed Escapements

### How To Order

CLICK OR SCAN

To view full  
catalog pages  
on this product

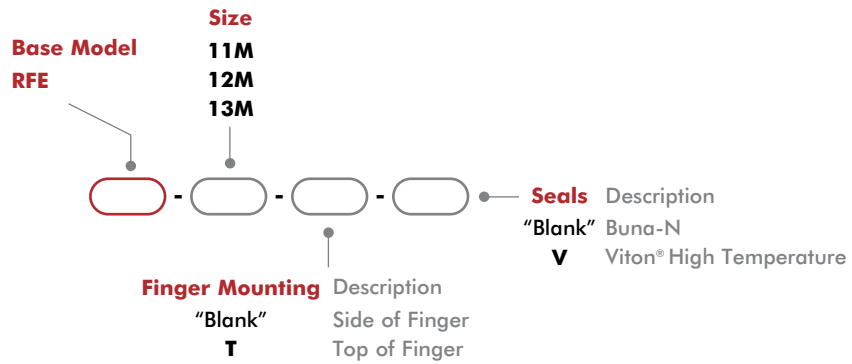
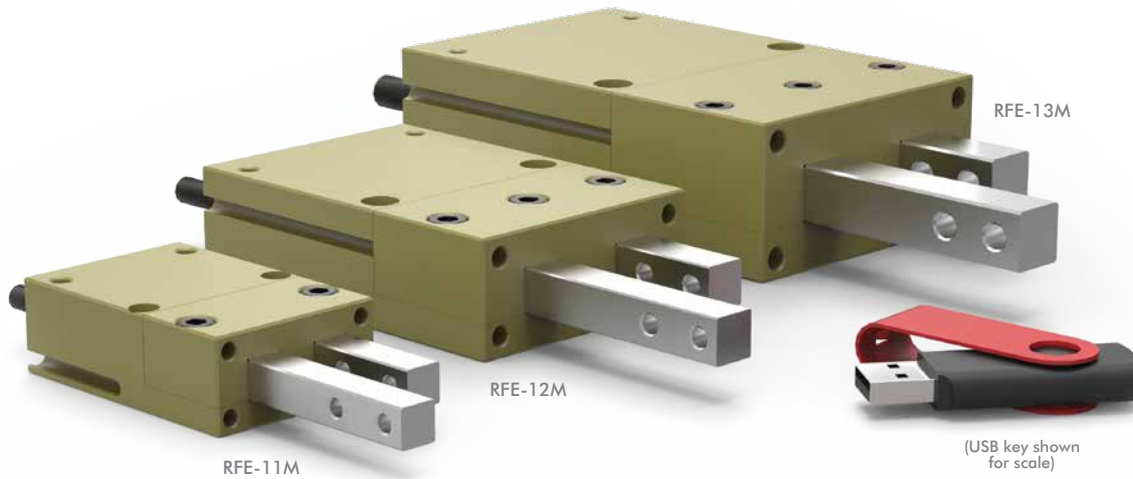

Size	Seal Repair Kits	
	Buna-N	Viton®
11M	SLKT-110	SLKT-110V
12M	SLKT-111	SLKT-111V
13M	SLKT-112	SLKT-112V

**CLICK OR SCAN**

To view full catalog pages on this product

# RFE SERIES

## Feed Escapements

### Basic Unit Dimensions

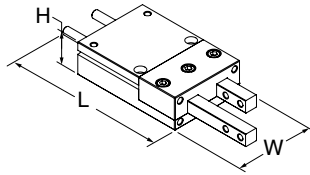

Size	L	W	H
11M	117 [4.59]	38.1 [1.50]	19.1 [0.75]
12M	162 [6.39]	57.2 [2.25]	24.9 [0.98]
13M	197 [7.74]	69.9 [2.75]	34.5 [1.36]

### Technical Data

Specifications	Units	11M	12M	13M
Thrust Force @ Maximum PSI	N [lbs]	111 [25]	222 [50]	400 [90]
Stroke	mm [in]	15.88 [0.625]	25.40 [1.000]	31.75 [1.250]
Stroke Adjustability	mm [in]	11 [0.44]	19 [0.75]	19 [0.75]
Weight	kg [lb]	0.15 [0.33]	0.39 [0.85]	0.83 [1.84]
Pressure Range	bar [psi]	3-7 [40-100]		
Cylinder Bore Ø	mm [in]	14.30 [0.563]	20 [0.787]	27 [1.063]
Rod Ø	mm [in]	6.35 [0.250]	7.95 [0.313]	9.52 [0.375]
Displacement	cm <sup>3</sup> [in <sup>3</sup> ]	2.6 [0.156]	8.0 [0.487]	18.2 [1.108]
Temperature Range (Buna-N seals)	°C [°F]	-35°~80° [-30°~180°]		
Temperature Range (Viton® seals)	°C [°F]	-30°~150° [-20°~300°]		
Actuation	sec	0.40	0.60	0.70
Parts Escaped per Minute		150	100	85
Valve to Actuate		4-way, 2-position		

### Accessories

Sensor Accessories	Model Numbers	Part Number	Qty/Unit
NPN Hall Effect Sensor with Quick Disconnect*	All Models	OHSN-017	1-2
PNP Hall Effect Sensor with Quick Disconnect*	All Models	OHSP-017	1-2
Quick Disconnect 2 Meter Cable Length*	All Models	CABL-010	1-2
Quick Disconnect 5 Meter Cable Length*	All Models	CABL-013	1-2

Pneumatic Accessories	Model Numbers	Part Number	Qty/Unit
M5 Adjustable Flow Control	All Models	VLVF-008	1-2

\*Sensor and cable sold separately.

# RN SERIES

## Feed Escapements

### How To Order

CLICK OR SCAN

To view full  
catalog pages  
on this product

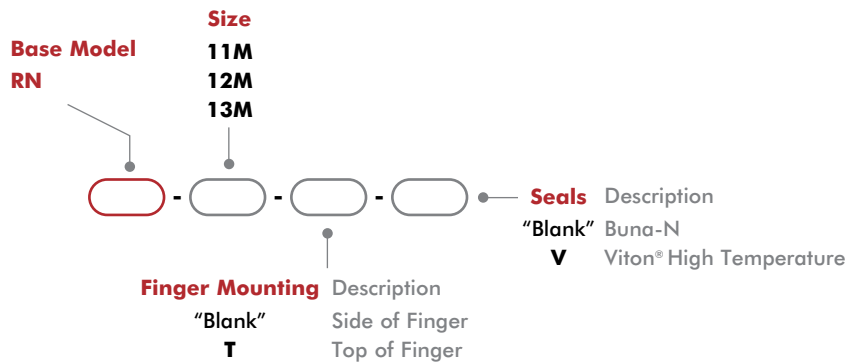

Size	Seal Repair Kits	
	Buna-N	Viton®
11M	SLKT-114	SLKT-114V
12M	SLKT-115	SLKT-115V
13M	SLKT-116	SLKT-116V



**CLICK OR SCAN**

To view full catalog pages on this product

# RN SERIES

## Feed Escapements

### Basic Unit Dimensions

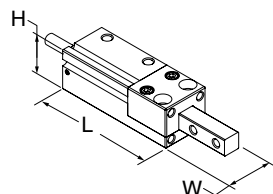

Size	L	W	H
11M	116 [4.59]	22.2 [0.88]	19.1 [0.75]
12M	161 [6.34]	28.6 [1.13]	24.9 [0.98]
13M	195 [7.70]	34.9 [1.38]	34.5 [1.36]

### Technical Data

Specifications	Units	11M	12M	13M
Thrust Force @ Maximun PSI	N [lbs]	111 [25]	222 [50]	400 [90]
Stroke	mm [in]	15.88 [0.625]	25.40 [1.000]	31.75 [1.250]
Stroke Adjustability	mm [in]	11 [0.44]	19 [0.75]	19 [0.75]
Weight	kg [lb]	0.09 [0.19]	0.19 [0.42]	0.41 [0.90]
Pressure Range	bar [psi]	3-7 [40-100]		
Cylinder Bore Ø	mm [in]	14.30 [0.563]	20 [0.787]	27 [1.063]
Rod Ø	mm [in]	6.35 [0.250]	7.95 [0.313]	9.52 [0.375]
Displacement	cm <sup>3</sup> [in <sup>3</sup> ]	1.3 [0.078]	4.0 [0.224]	9.1 [0.554]
Temperature Range (Buna-N seals)	°C [°F]	-35°~80° [-30°~180°]		
Temperature Range (Viton® seals)	°C [°F]	-30°~150° [-20°~300°]		
Actuation	sec	0.14	0.21	0.28
Valve to Actuate		4-way, 2-position		

### Accessories

Sensor Accessories	Model Numbers	Part Number	Qty/Unit
NPN Hall Effect Sensor with Quick Disconnect*	All Models	OHSN-006	1-2
PNP Hall Effect Sensor with Quick Disconnect*	All Models	OHSP-006	1-2
Quick Disconnect 2 Meter Cable Length*	All Models	CABL-010	1-2
Quick Disconnect 5 Meter Cable Length*	All Models	CABL-013	1-2

Pneumatic Accessories	Model Numbers	Part Number	Qty/Unit
M5 Adjustable Flow Control	All Models	VLVF-008	1-2

\*Sensor and cable sold separately.

# ROBOTIC TOOLING SOLUTIONS

**CLICK OR SCAN**  
To view full catalog pages  
on these product

## Automatic Tool Changers | Features and Benefits

### Automatic Tool Changers

#### Robotic Applications:

Perfect for those flexible/multiple tooling applications utilizing one Robot. This product was designed with exceptional repeatability, high rigidity & load capacity to make it ideal for any robotic application.

#### Automation Applications:

End effector tooling and interchangeable fixturing can be changed quickly and easily to accommodate many different styles of parts on the same assembly machine or machining center.

#### Highly Configurable, Modular Design (RQC/RTP):

The Modular RQC series easily accommodates up to (4) optional modular interfaces, offering a high level of flexibility.

### Mounting Information

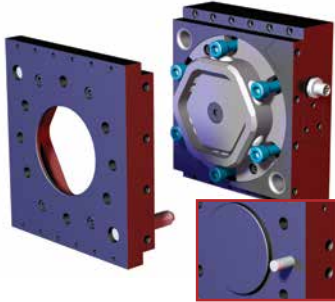

**RQC Robot Half Adaptor**  
Counterbored holes for mounting with a dowel pin hole, a raised boss for location and a ISO9409-1 mounting pattern.

#### Back Side of RQC

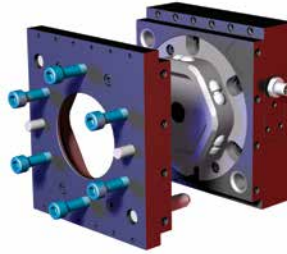

**RTP Tool Half Adaptor**  
Tapped holes, two dowel pin holes for accurate location of payload and a ISO9409-1 mounting pattern.



**QC Robot Half Adaptor**  
has counterbored holes for mounting and two dowel pins for hole location (size 30 has pilot boss).



**TP Tool Half Adaptor**  
has counterbored holes for mounting and two dowel pins for hole location (size 30 has pilot boss).



**RHC Robot Half Adaptor**  
mounts with screws from behind or through the front and locates with dowel pins for accuracy.



**RHC Tool Half Adaptor**  
mounts payload with screws from behind or through the front and locates with dowel pins for accuracy. Protect cone surfaces from debris to insure proper positioning.



## Compliance Device | Features and Benefits

#### Flexibility of the Tool:

Cylindrical Horizontal compliance devices are used for inserting components that may be misaligned with the tool. They allow a horizontal displacement that compensates for part placing inaccuracies.

#### For Precision Applications:

High quality components allows for centering repeatability from 0.02mm and angular repeatability from  $\pm 10^\circ$ .

#### Harsh Environments:

Enclosed design allows them to be used in harsh environments.

#### Spring Assist:

Optional spring assist allows for use in single acting mode.



### Mounting Information



**CH Horizontal Compliance**  
The compliance is located using a pilot boss and a dowel pin and assembled using 4 or 6 through body screws.

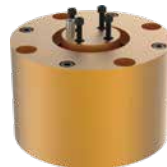

#### Tool Mounting

Tooling is located using a centering and a dowel pin and assembled using 4 screws.



**CLICK OR SCAN**

To view full catalog pages on this product

# RQC/RTP SERIES

## Automatic Tool Changers | Technical Information

### RQC-200/RTP-200

**Combined Weight:** 3 Kg [6.7 lb]

**Max. Payload:** 90 Kg [200 lb]

**Max. Moment:** 810 Nm [7200 in-lb]

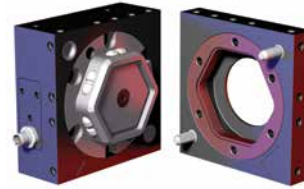
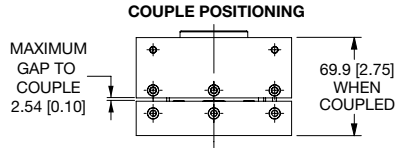

**RQC-200** **RTP-200**  
Robot Adaptor Module Tool Adaptor Module

### RQC-400/RTP-400

**Combined Weight:** 4.7 Kg [10.4 lb]

**Max. Payload:** 180 Kg [400 lb]

**Max. Moment:** 1580 Nm [14000 in-lb]

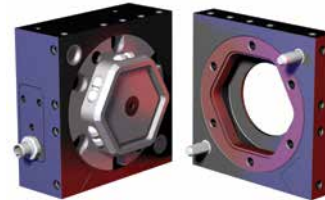
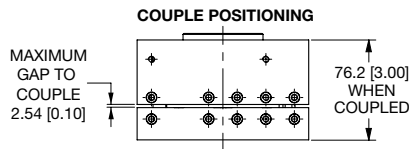

**RQC-400** **RTP-400**  
Robot Adaptor Module Tool Adaptor Module

### RQC-800/RTP-800

**Combined Weight:** 7.1 Kg [15.8 lb]

**Max. Payload:** 360 Kg [800 lb]

**Max. Moment:** 2490 Nm [22000 in-lb]

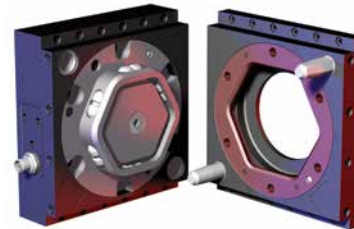
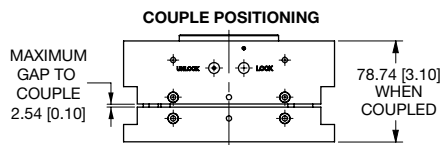

**RQC-800** **RTP-800**  
Robot Adaptor Module Tool Adaptor Module

### RQC-1200/RTP-1200

**Combined Weight:** 8.3 Kg [18.4 lb]

**Max. Payload:** 550 Kg [1200 lb]

**Max. Moment:** 3390 Nm [30000 in-lb]

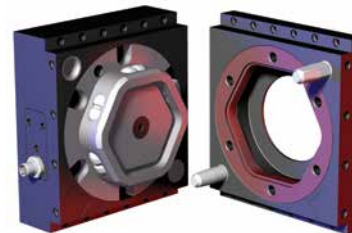
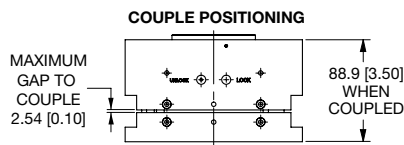

**RQC-1200** **RTP-1200**  
Robot Adaptor Module Tool Adaptor Module

### RQC-2400/RTP-2400

**Combined Weight:** 30 Kg [66.1 lb]

**Max. Payload:** 1089 Kg [2400 lb]

**Max. Moment:** 7000 Nm [61955 in-lb]

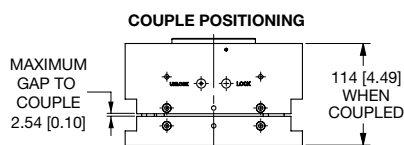

**RQC-2400** **RTP-2400**  
Robot Adaptor Module Tool Adaptor Module

# QC/TP, RHC SERIES

**CLICK OR SCAN**  
To view full catalog pages  
on these product

## Automatic Tool Changers | Features and Benefits

### QC Series Tool Changers



#### QC-30 Robot Adaptor Module



#### TP-30 Tool Adaptor Module

**Combined Weight:** 0.34 Kg [0.75 lbs]  
**Max. Payload:** 13.6 Kg [30 lbs]  
**Max. Moment:** 22.6 Nm [200 in-lbs]

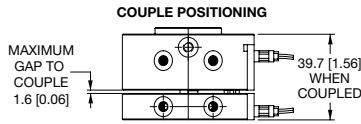

#### QC-60 Robot Adaptor Module



#### TP-60 Tool Adaptor Module

**Combined Weight:** 1.27 Kg [2.8 lbs]  
**Max. Payload:** 27 Kg [60 lbs]  
**Max. Moment:** 88.1 Nm [780 in-lbs]

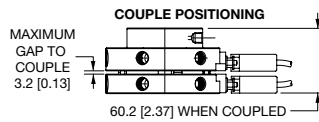

#### QC-60-10P Robot Adaptor Module



#### TP-60-10P Tool Adaptor Module

**Combined Weight:** 1.27 Kg [2.8 lbs]  
**Max. Payload:** 27 Kg [60 lbs]  
**Max. Moment:** 88.1 Nm [780 in-lbs]

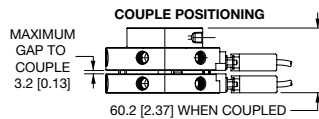

#### QC-150 Robot Adaptor Module



#### TP-150 Tool Adaptor Module

**Combined Weight:** 3.2 Kg [7.1 lbs]  
**Max. Payload:** 68 Kg [150 lbs]  
**Max. Moment:** 215 Nm [1900 in-lbs]

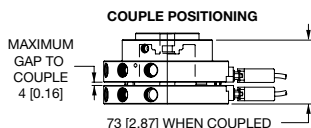

### RHC Series Tool Changers



#### RHC-1-R Robot Adaptor Module



#### RHC-1-T Tool Adaptor Module

**Combined Weight:** 0.29 Kg [0.63 lbs]  
**Max. Payload:** 9 Kg [20 lbs]  
**Max. Moment:** 28 Nm [250 in-lbs]

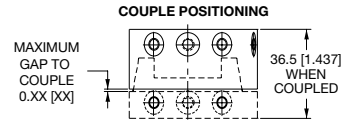

#### RHC-2-R Robot Adaptor Module



#### RHC-2-T Tool Adaptor Module

**Combined Weight:** 0.82 Kg [1.81 lbs]  
**Max. Payload:** 59 Kg [130 lbs]  
**Max. Moment:** 136 Nm [1200 in-lbs]

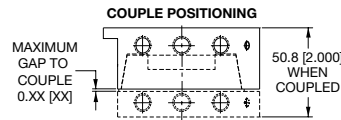

#### RHC-4-R Robot Adaptor Module



#### RHC-3-T Tool Adaptor Module

**Combined Weight:** 3.1 Kg [6.8 lbs]  
**Max. Payload:** 136 Kg [300 lbs]  
**Max. Moment:** 1017 Nm [9000 in-lbs]

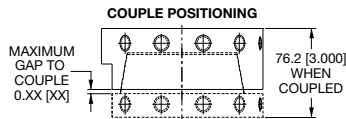

#### RHC-4-R Robot Adaptor Module



#### RHC-4-T Tool Adaptor Module

**Combined Weight:** 11 Kg [24.3 lbs]  
**Max. Payload:** 454 Kg [1000 lbs]  
**Max. Moment:** 2825 Nm [25000 in-lbs]

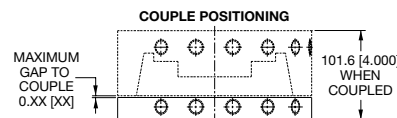

# ROBOTIC TOOLING SOLUTIONS

## Tool Changer Docking Station

Destaco offers custom and standard Docking Stations to fit customers needs. Please contact Destaco Sales for more information.

**Key Features:**

- Allows for quick changing of tooling
- Reducing machine down-time
- Safely stores tooling when not in use
- Standard or custom stations

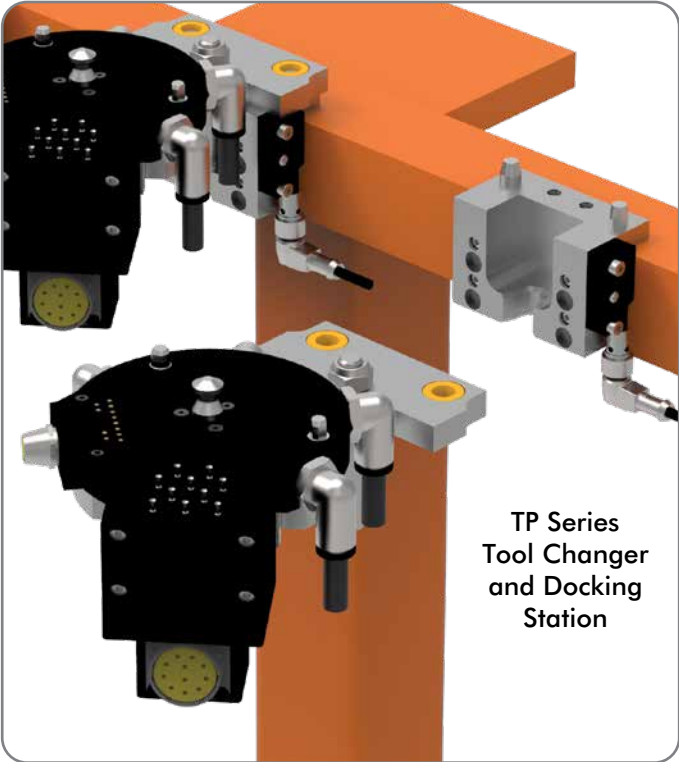
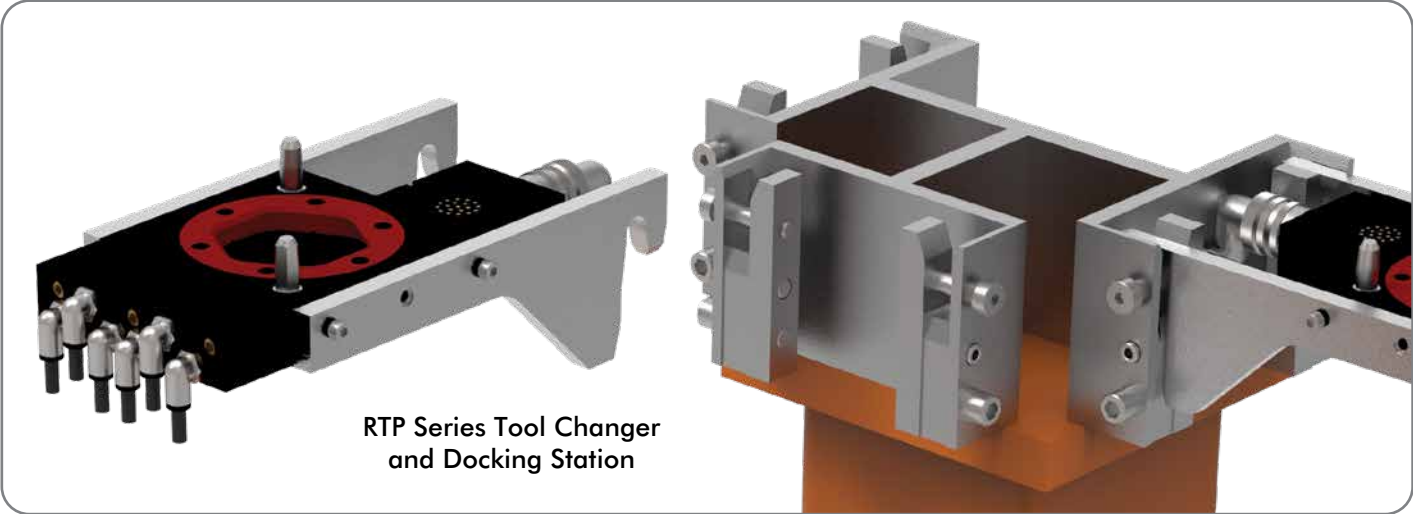

# OUR PORTFOLIO OF PRODUCTS



## End Effectors (EE)

- Tool Changers
- End-of-Arm Tooling
- Vacuum Products
- Palletizing Solutions



## Grippers (GR)

- Electric Grippers
- Pneumatic and Sheet Metal Grippers
- Rotates
- Slides



## Indexers (IN)

- Precision Conveyors
- Dial Indexers
- Shaft and Flange Indexers
- Part Handlers

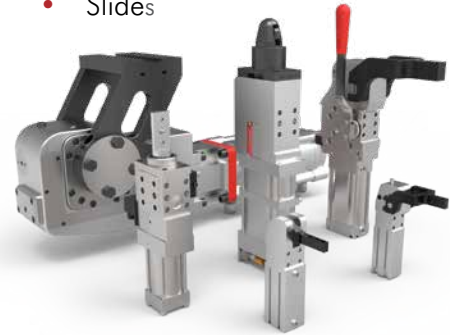

## Power Clamps (PC)

- Power Clamps
- Pin Clamps and Packages
- Pivot Units
- Power Cylinders



## Manual Clamps (MC)

- Hold Down
- Squeeze Action
- Plunger, Hook and Latch
- Pneumatic Toggle and Swing



## Sheet Metal Grippers (SG)

- Accelerate® Press Room
- Cam Type
- Toggle Lock