

603, 608 SERIES

Straightline Action Clamps | Product Overview

Features:

- Allow handle to rotate and fall below mounting plane to lock in retracted position
- Large holding capacities for their size
- Available with DESTACO® Toggle Lock Plus

Applications:

- Assembly & test
- Checking fixtures
- Welding fixtures
- Tensioning devices

Also Available:

See page MC-ACC-1 for accessories

803 Pneumatic Toggle Clamp
See page MC-PTC-27

803-ME Pneumatic Toggle Clamp
See page MC-PTC-27

Covered under one or more U.S./International Patents

603
603-M

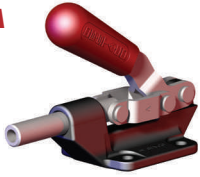

603-SS
603-MSS
Stainless
Steel



603-R
603-MR
with
DESTACO®
Toggle Lock
Plus



608
608-M

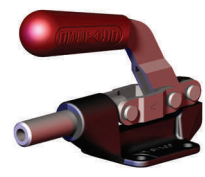

Technical Information, Holding Capacities

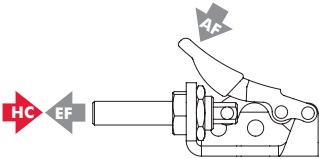

Model	Max. Holding Capacity	Weight	EF:AF (pushing/pulling)	Plunger Travel	(M) Plunger Thread	Recommended Spindle (Not Supplied)
603	[600 lbf] 2670 N				5/16-18	207203
603-M					M8	207203-M
603-SS	[840 lbf] 3740 N	[0.83lb] 0,38kg	23:1/34:1	[1.25] 31,8	5/16-18	207943
603-MSS					M8	207943-M (supplied)
603-R	[600 lbf] 2670 N				5/16-18	207203
603-MR					M8	207203-M
608	[850 lbf] 3780 N	[1.25lb] 0,57kg	44:1/50:1	[1.63] 41,3	3/8-16	210203
608-M					M10	210203-M

HC = Holding Capacity, EF = Exerting Force, AF = Applied Force

603, 608 SERIES

Straightline Action Clamps | Dimensions | 603/608/-M/-SS/-MSS/-R/-MR

603
603-M

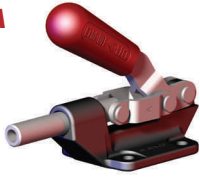

603-SS
603-MSS
Stainless
Steel



603-R
603-MR
with
DESTACO®
Toggle Lock
Plus

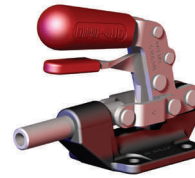

608
608-M

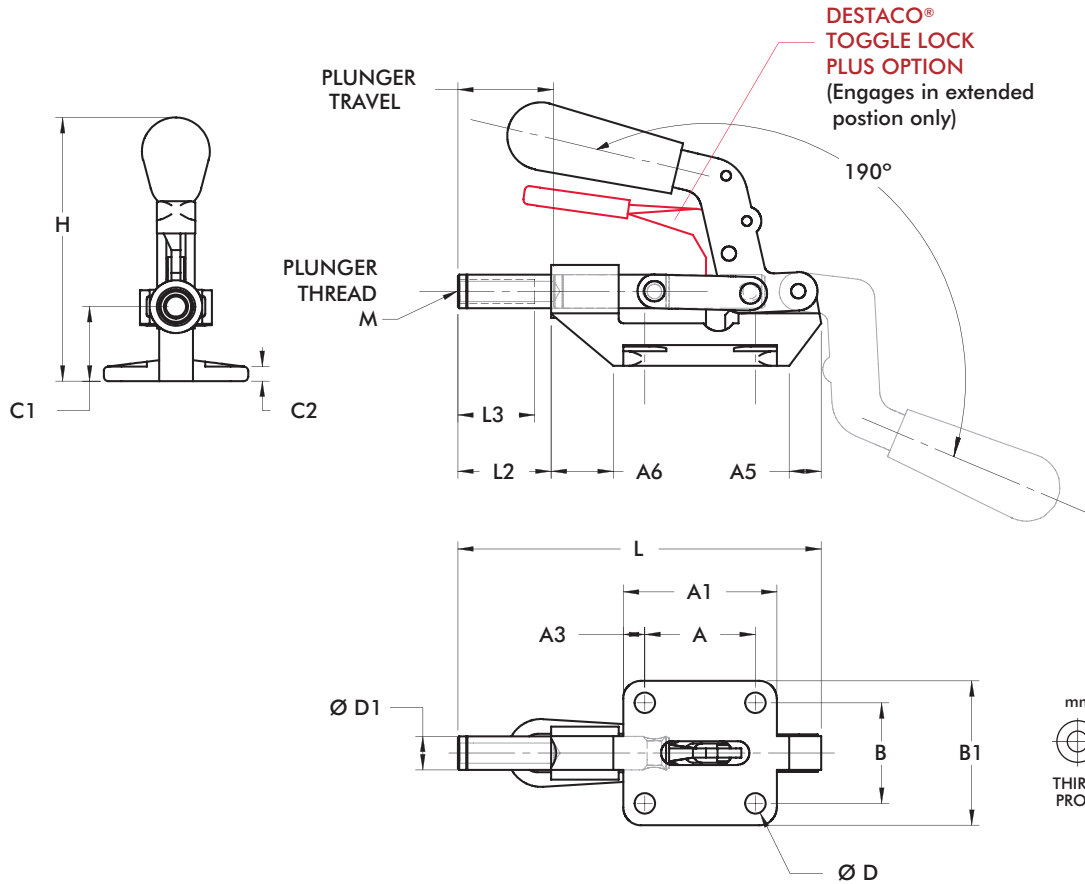
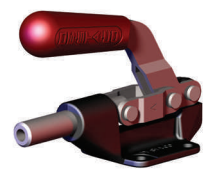

Model	A	A1	A3	A5	A6	B	B1	C1	C2	D	D1	H	L	L2	L3
603		[2.17]	[0.34]	[0.51]	[0.82]				[0.19]		[0.44]	[3.43]	[4.77]		
603-M		55	8,5	13	21				4,8		11,1	87	121,2		
603-SS	[1.44]			[0.54]	[0.65]	[1.31]	[1.88]	[0.97]	[0.25]	[0.27]	[0.47]	[3.28]	[4.69]	[1.28]	[1.00]
603-MSS	36,6	[2.20]	[0.30]	13,6	16,5	33,3	48	24,6	6,4	6,8	12	83,4	119,2	32,5	25,4
603-R			7,5	[0.51]	[0.82]						[0.44]	[3.43]	[4.77]		
603-MR				13	21				[0.19]		11,1	87	121,2		
608	[1.63]	[2.25]	[0.31]	[0.75]	[1.40]	[1.63]	[2.25]	[1.25]	4,8	[0.33]	[0.62]	[4.04]	[6.00]	[1.59]	[1.25]
608-M	41,4	57,2	8	19	36	41,4	57,2	31,8		8,4	15,8	102,6	152,3	40,5	31,8

Dimensions shown mm [inch]