

217 SERIES

Horizontal Hold Down Clamps | Product Overview

Features:

- Low profile
- Large handle clearance in the open position
- Available in stainless steel
- BLK models feature a black, non-reflective finish

Applications:

- Assembly
- Checking fixtures
- Closures
- Woodworking

Also Available:

See page MC-ACC-1 for accessories
Accommodates M6 or 1/4" spindle accessory

217-U
Flanged Base
U-Bar

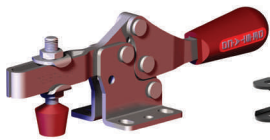

217-U-LS-BLK ⓘ
Blackout Series
Flanged Base
U-Bar



217-USS
Flanged Base
U-Bar, Stainless
Steel

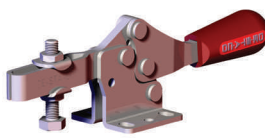

217-UB
Straight Base
U-Bar

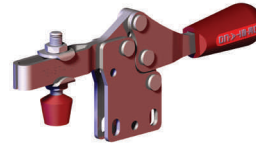

217-UB-LS-BLK ⓘ
Blackout Series
Straight Base
U-Bar



217-U-L ⓘ
Flanged Base
Open Bar

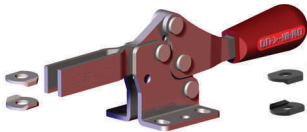

217-U-L-BLK ⓘ
Flanged Base
Open Bar



217-UB-L ⓘ
Straight Base
Open Bar

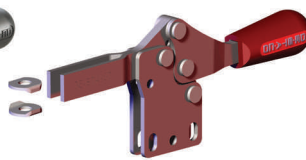

217-UB-L-BLK ⓘ
Blackout Series
Straight Base
Open Bar



Note: Clamps shown with included accessories.

ⓘ This item is available upon request

Technical Information

Model	Max. Holding Capacity	Clamp Bar Opening (+10°)	Handle Opening (+10°)	Weight	Accessories (Supplied)	
					Spindle Assembly	Flanged Washers
217-U	900 N [200 lbf]	91°	61°	0,18kg [0.40lb]	202208-M	215105
217-U-LS-BLK ⓘ					--	215105-BLK
217-USS	1110 N [250 lbf]				202943-M	215105
217-UB					202208-M	215105
217-UB-LS-BLK ⓘ						215105-BLK
217-U-L ⓘ	900 N [200 lbf]					215105
217-U-L-BLK ⓘ					--	215105-BLK
217-UB-L ⓘ						215105
217-UB-L-BLK ⓘ			215105-BLK			

ⓘ This item is available upon request

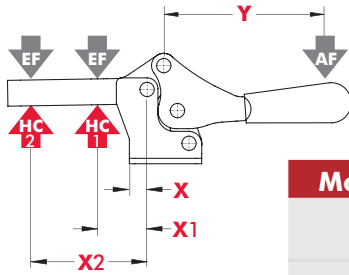

Model	X	X1	X2	Y	±HC1	±HC2	±EF(X1):AF	±EF(X2):AF
U					[200lbf.] 900N	[80lbf.] 360N		
USS	[0.53] 13,5	[1.13] 28,6	[2.63] 66,8	[2.93] 74,5	[250lbf.] 1110N	[100lbf.] 440N	7:1	3:1
UB/U-L/ UB-L					[200lbf.] 900N	[80lbf.] 360N		

Dimensions shown "mm [inch]" ± HC = Holding Capacity, EF = Exerting Force, AF = Applied Force
Refer to See page MC-TEC-4 for additional information.

Standard Clamp Dimensions | -U/-USS/-UB

Series 217 Open Bar Options

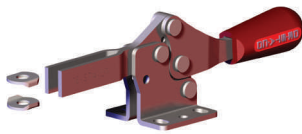

Flanged Base
Model
217-U-L ⓘ

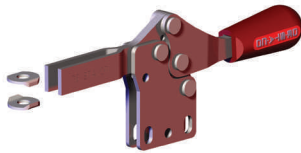

Straight Base
Model
217-UB-L ⓘ

See page MC-ACC-7 for
Complete offering of
Open bar accessories

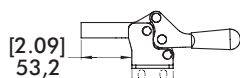
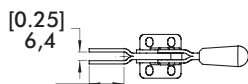

217-U Flanged Base U-Bar

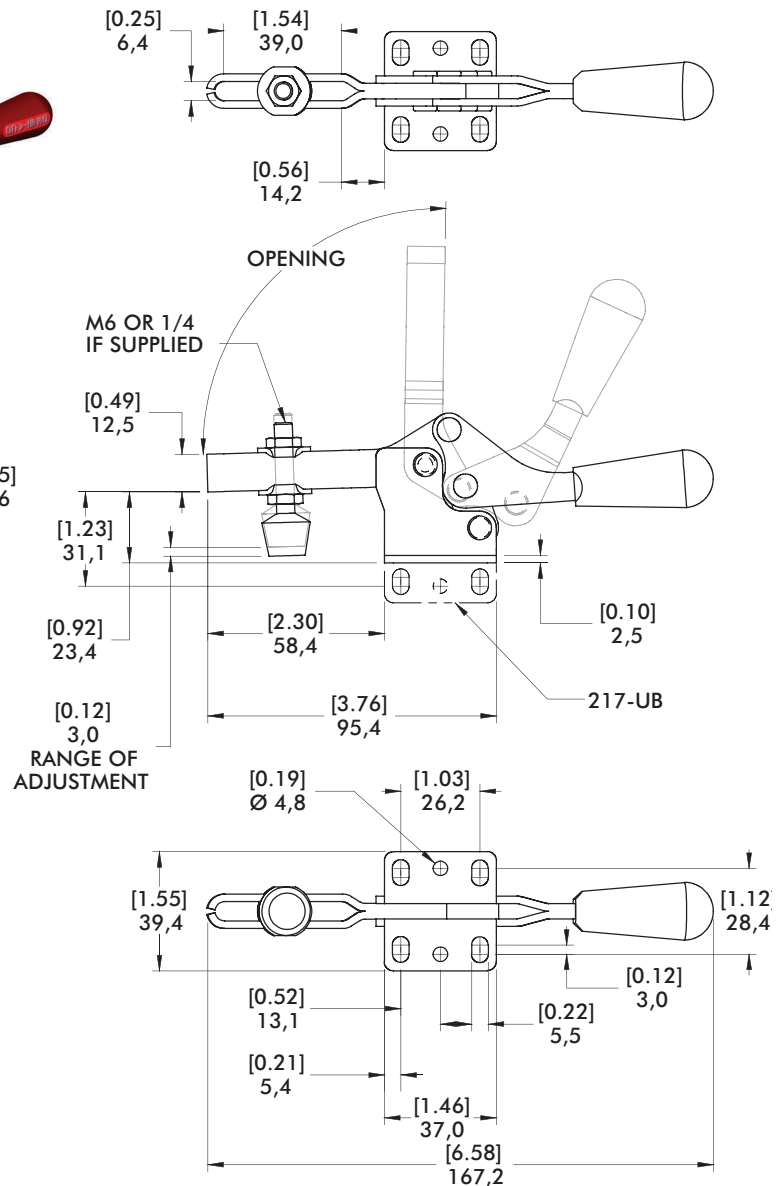
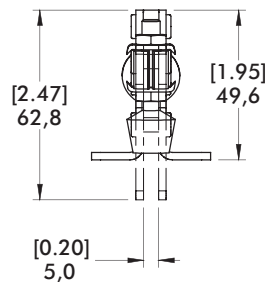
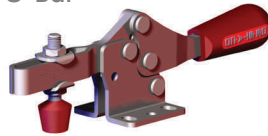

mm [INCH]
THIRD ANGLE
PROJECTION