

210 SERIES

Vertical Hold Down Clamps | Product Overview

Features:

- DESTACO® Toggle Lock Plus versions available
- Available in stainless steel
- Accommodates M10 or 3/8 spindle accessories

Applications:

- Assembly & test
- Light machining
- Light welding

Also Available:

See page MC-ACC-1 for accessories
 810-U Pneumatic Toggle Clamp
 (See page MC-PTC-9)
 810-S Pneumatic Toggle Clamp
 (See page MC-PTC-9)

210-U
Flanged Base
U-Bar

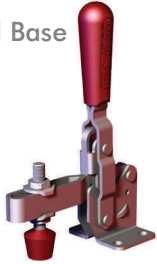

210-USS
Flanged Base
U-bar, Stainless
Steel



210-S
Flanged Base
Solid Bar

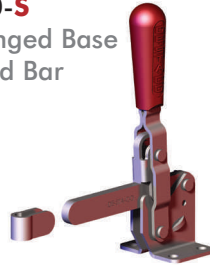

210-UB
Straight Base
U-bar

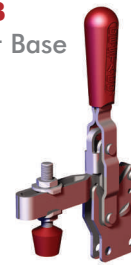

210-SB
Straight Base,
Solid Bar



210-UR
Flanged Base
U Bar
with
DESTACO®
Toggle Lock
Plus

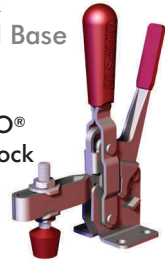

210-SR
Flanged Base
Solid Bar
with
DESTACO®
Toggle Lock
Plus



210-TU
Flanged Base
U Bar,
T-Handle

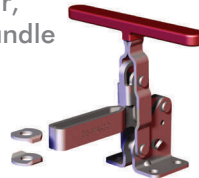

Note: Clamps shown with included accessories.

Technical Information

Model	Max. Holding Capacity	Clamp Bar Opening (+10°)	Handle Opening (+10°)	Weight	Accessories (Supplied)		
					Bolt Retainer	Spindle Assembly	Flanged Washers
210-U	2670 N [600 lbf]	103°	58°	0,59kg [1.29lbs]	---	240208-M	235106
210-USS	3340 N [750 lbf]				---	237943-M	235906
210-S					210114	237943-M	---
210-UB	2670 N [600 lbf]				---	240208-M	235106
210-SB	3340 N [750 lbf]			210114	---	---	
210-UR	2670 N [600 lbf]			0,73kg [1.60lbs]	---	240208-M	235106
210-SR	3340 N [750 lbf]				210114	---	---
210-TU	2670 N [600 lbf]				0,62kg [1.36lbs]	---	---

Vertical Hold Down Clamps | Holding Capacities

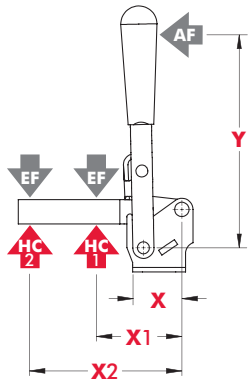

Model	X	X1	X2	Y	±HC1	±HC2	±EF(X1):AF	EF(X2):AF
U/UB/UR	[1.54] 39	[2.38] 60,5	[4.88] 124	[6.75] 171,5	[600lbf.] 2670N	[290lbf.] 1290N	14:1	7:1
USS		[3.62] 92,0	[5.25] 133	[4.50] 114,5	[750lbf.] 3340N	[360lbf.] 1600N		
S/SR/SB		[2.38] 60,5	[4.88] 124	[6.75] 171,5	[750lbf.] 3340N	[500lbf.] 2220N	11:1	9:1
TU		[2.38] 60,5	[4.88] 124	[6.75] 171,5	[600lbf.] 2670N	[290lbf.] 1290N		

Dimensions shown "mm [inch]" ± HC = Holding Capacity, EF = Exerting Force, AF = Applied Force
Refer to See page MC-TEC-4 for additional information.

Dimensions | -U/-USS/-S/-UB/-SB/-UR/-SR/-TU

210-U

Flanged Base
U-Bar

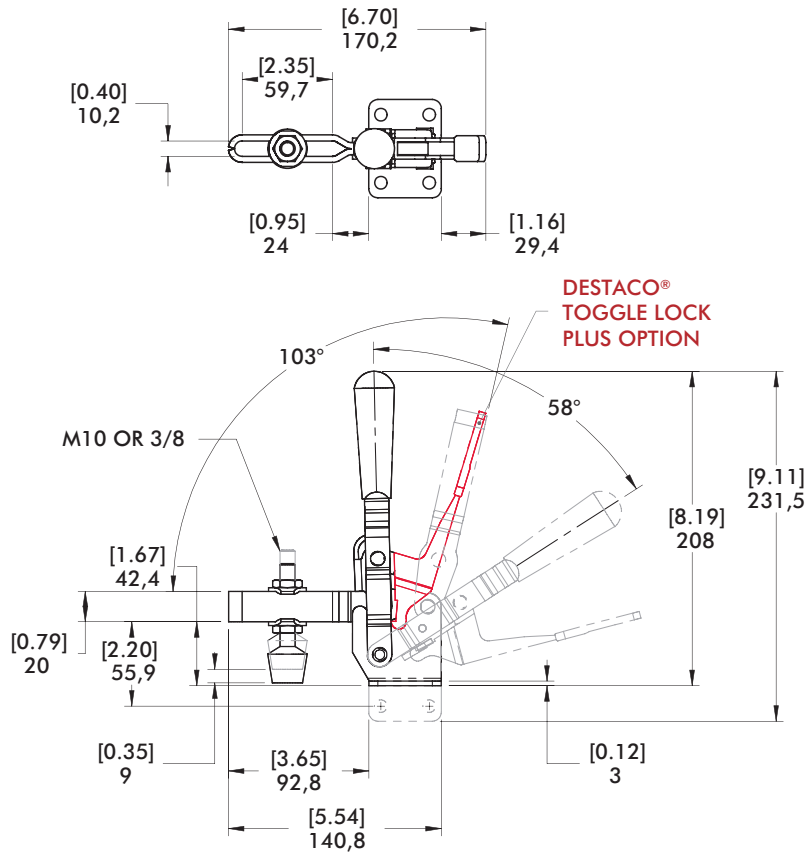
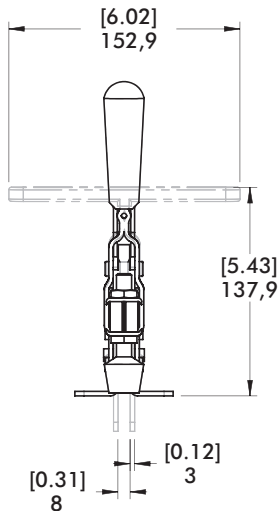
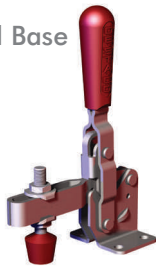

210-SR

Flanged Base
Solid Bar
with
DESTACO®
Toggle Lock
Plus

