

# 202 SERIES

## Vertical Hold Down Clamps | Product Overview

### Features:

- Two bar styles available
- Low profile T-Handle version available
- Available in stainless steel
- Accommodates M6 or 1/4" spindle accessories
- BLK models feature a black, non-reflective finish

### Applications:

- Checking fixtures
- Assembly & test
- Light machining
- Woodworking

### Also Available:

See page MC-ACC-1 for accessories

802-U Pneumatic Toggle Clamp  
(See page MC-PTC-5)

**202-U**  
Flanged Base  
U-Bar

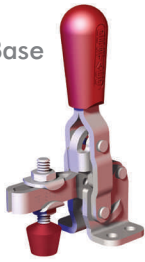

**202-UL**  
Flanged Base  
Long U-Bar

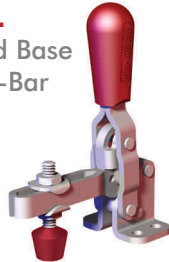

**202-USS**  
Flanged Base  
U-bar, Stain-  
less Steel

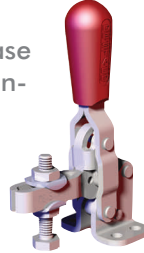

**202**  
Flange Base  
Solid Bar

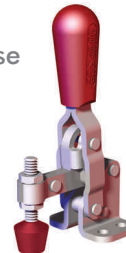

**202-SS**  
Flanged Base  
Solid Bar  
Stainless Steel



**202-UB**  
Straight Base  
U-bar

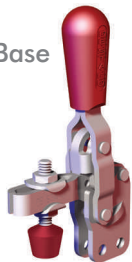

**202-B**  
Straight Base  
Solid Bar

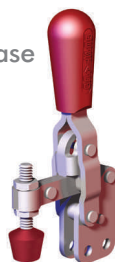

**202-TU**  
Flanged Base  
U-bar,  
T-Handle

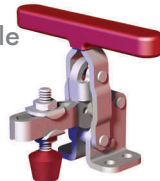

**202-T**  
Flanged Base  
Solid Bar  
T-Handle

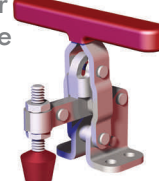

**202-U-L** ⓘ  
Flanged Base  
Open U-Bar

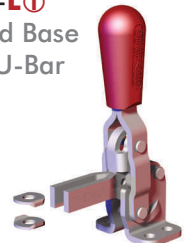

**202-U-L-BLK** ⓘ  
Blackout Series  
Flanged Base  
Open U-Bar



**202-UB-L** ⓘ  
Straight Base  
Open U-Bar

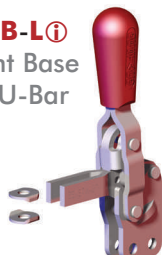

**202-UB-L-BLK** ⓘ  
Blackout Series  
Straight Base  
Open U-Bar



**202305**

Flanged Grip.  
Provides added safety  
and protection. Fits all  
202 Series (except  
T-Handle) clamps.  
Order separately.



Note: Clamps shown with included accessories.

ⓘ This item is available upon request

Model	Max. Holding Capacity	Clamp Bar Opening (+10°)	Handle Opening (+10°)	Weight	Accessories (Supplied)	
					Spindle Assembly	Flanged Washers
202-U	890 N [200 lbf]	105°	65°	0,16kg [0.35lbs]	202208-M	215105
202-UL	890 N [200 lbf]				202943-M	215905
202-USS	1110 N [250 lbf]			202208-M	---	
202	890 N [200 lbf]			205943-M	---	
202-SS	1110 N [250 lbf]			0,16kg [0.35lbs]	202208-M	215105
202-UB	890 N [200 lbf]			0,15kg [0.33lbs]		
202-B	890 N [200 lbf]			0,17kg [0.38lbs]		
202-TU	890 N [200 lbf]			0,16kg [0.35lbs]		
202-U-L ⓘ	890 N [200 lbf]			---	---	
202-U-L-BLK ⓘ	890 N [200 lbf]			---	---	
202-UB-L ⓘ	890 N [200 lbf]			---	---	
202-UB-L-BLK ⓘ	890 N [200 lbf]			---	---	

ⓘ This item is available upon request

### Holding Capacities

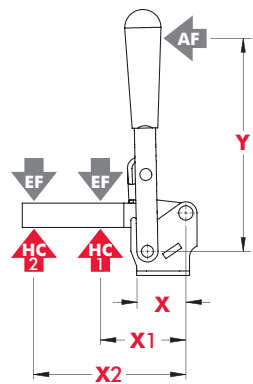

Model	X	X1	X2	Y	±HC1	±HC2	±EF(X1):AF	±EF(X2):AF
202-U	[0.79] 20	[1.25] 32	[2.25] 57	[3.42] 87	[200 lbf] 890N	[140 lbf] 625N	10:1	5:1
202-UL			[2.88] 73	[150 lbf] 670N	4:1			
202-USS		[2.25] 57	[3.00] 76	[250 lbf] 1110N	[170 lbf] 760N	5:1		
202		---	[1.88] 48	[3.42] 87	---	[200 lbf] 890N	---	8:1
202-SS		---	[3.00] 76	---	[250 lbf] 1110N	---	---	---
202-UB		[1.25] 32	[2.25] 57	[3.42] 87	[200 lbf] 890N	[140 lbf] 625N	10:1	5:1
202-B		---	[1.88] 48	---	[200 lbf] 890N	---	---	8:1
202-TU		[1.25] 32	[2.25] 57	[2.13] 54	[200 lbf] 890N	[140 lbf] 625N	11:1	7:1
202-T		---	[1.88] 48	---	[200 lbf] 890N	---	---	6:1
202-U-L ⓘ		---	---	---	---	---	---	---
202-U-L-BLK ⓘ		[1.25] 32	[2.25] 57	[3.42] 87	[200 lbf] 890N	[140 lbf] 625N	10:1	5:1
202-UB-L ⓘ		---	---	---	---	---	---	---
202-UB-L-BLK ⓘ		---	---	---	---	---	---	---

Dimensions shown "mm [inch]" ± HC = Holding Capacity, EF = Exerting Force, AF = Applied Force

ⓘ This item is available upon request

# 202 SERIES

## Vertical Hold Down Clamps | Dimensions | 202-/U-/UL-/USS-/SS-/UB-/B-/TU-/T

**202-U**  
Flanged Base  
U-Bar

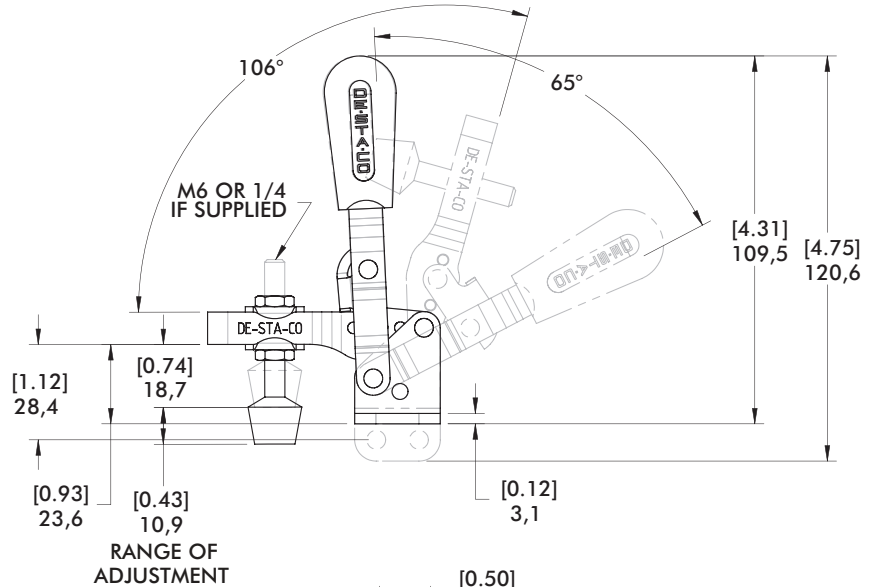
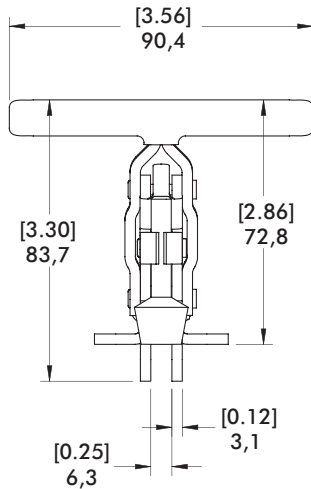
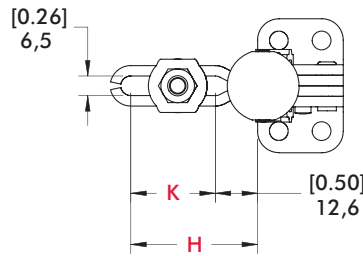
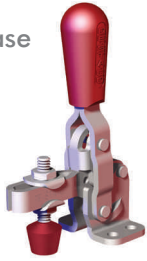

**Open Bar  
Option**

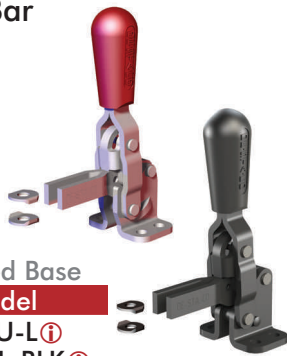

See page  
MC-ACC-7  
for complete  
offering of open  
bar accessories

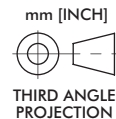
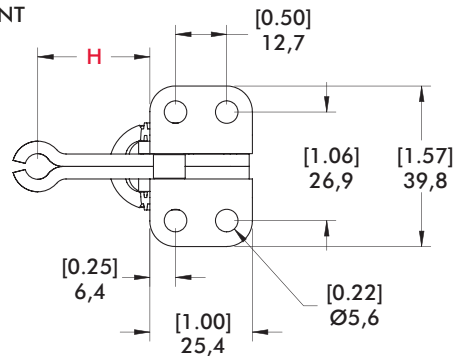

Flanged Base  
**Model**

202-U-L ⓘ  
202-U-L-BLK ⓘ

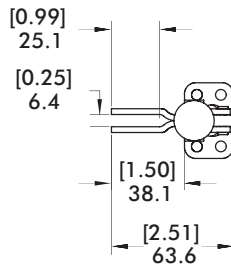

Straight Base  
**Model**

202-UB-L ⓘ  
202-UB-L-BLK ⓘ



Bar Style	Clamp Models	H	K
	202-U/202-UB/ 202-USS/202-TU	[1.73] 44,1	[0.98] 25
	202-UL ⓘ	[2.29] 58,1	[1.51] 38,4
	202/202-B/ 202-T/202-SS	[1.08] 27,4	---
	202-U-L ⓘ/ 202-UB-L ⓘ	[1.50] 38,1	---

ⓘ This item is available upon request

# VERTICAL HOLD DOWN CLAMPS

## Application Example

### Application Areas

Clamping during the assembling, drilling, testing, gluing, locking of covers and much more. The vertical clamp is the most frequently used product whenever clamping products are to be integrated with a manual fixture.

### The essential product features

- In the clamping position, the handle is vertical
- Vertical clamps open at an angle between 75° and 215°
- Vertical clamps are offered with U-shaped or heavy-duty solid clamping bars
- Vertical clamps have a straight or flanged base.  
The heavy-duty vertical clamps possess a base that can be welded on without a hole pattern

