

DGC/GC SERIES

2-Jaw Precision Parallel Grippers | Features and Benefits | How To Order

Features:

- Rugged, high precision long stroke gripper
- High impact resistant with double wedge design
- Versatile mounting on top or sides of gripper
- Spring assist option maintains grip in case of air pressure loss
- Two end of stroke inductive sensing positions supported
- DIRECTCONNECT™ mounting (DGC only)
- Shielded design to repel chips and particulates

Applications:

- Machining and harsh environment applications
- High vibration and impact applications
- Pick and Place applications

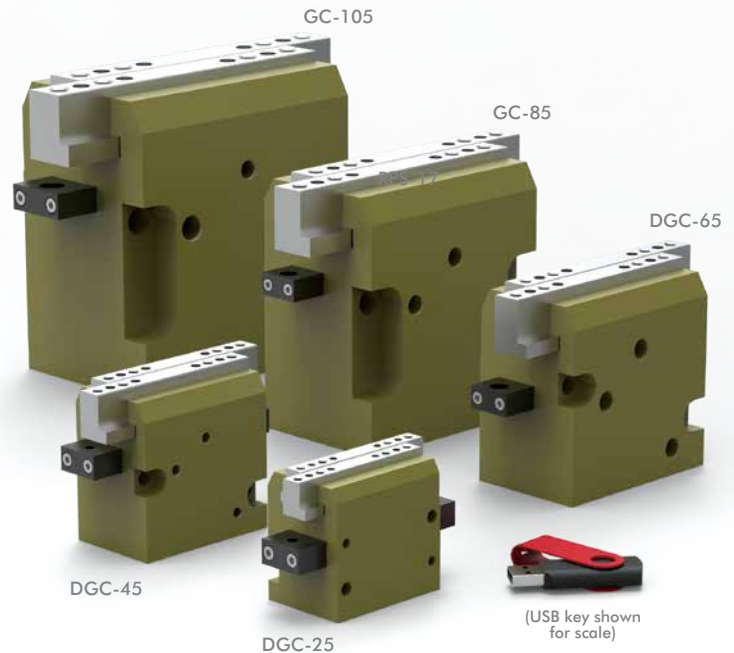

How To Order

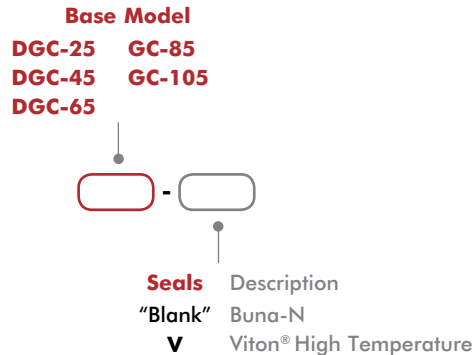

Accessories

Sensor Accessories	Model Numbers	Part Number	Qty/Unit
4mm NPN Inductive Sensor with Quick Disconnect*	25, 45	OHSN-014	1-2
4mm PNP Inductive Sensor with Quick Disconnect*	25, 45	OHSP-014	1-2
8mm NPN Inductive Sensor with Quick Disconnect*	65, 85	OHSN-011	1-2
8mm PNP Inductive Sensor with Quick Disconnect*	65, 85	OHSP-011	1-2
12mm NPN Inductive Sensor with Quick Disconnect*	105	OISN-017	1-2
12mm PNP Inductive Sensor with Quick Disconnect*	105	OISP-017	1-2
Quick Disconnect 2 Meter Cable Length*	24, 45, 65, 85	CABL-010	1-2
Quick Disconnect 5 Meter Cable Length*	24, 45, 65, 85	CABL-013	1-2
Quick Disconnect 2 Meter Cable Length*	105	CABL-014	1-2
Quick Disconnect 5 Meter Cable Length*	105	CABL-018	1-2

*Sensor and cable sold separately.

2-Jaw Precision Parallel Grippers | Technical Specifications

Specifications	Units	25	45	65	85	105
Total Rated Grip Force F @ 100 psi [7 bar]	N [lb]	474 [106]	481 [108]	796 [179]	1480 [333]	2318 [521]
Total Stroke	mm [in]	20 [0.787]	30 [1.181]	40 [1.575]	50 [1.968]	60 [2.362]
Weight	kg [lbs]	0.35 [0.77]	0.60 [1.32]	1.30 [2.87]	2.20 [4.85]	4.31 [9.50]
Pressure Range	bar [psi]	3-7 [45-100]				
Ingress Protection Class (IP)		IP54				
Displacement	cm ³ [in ³]	16 [0.98]	29 [1.77]	62 [3.78]	136 [8.30]	261 [15.93]
Temperature Range (Buna-N seals)	°C [°F]	-35°~80° [-30°~180°]				
Temperature Range (Viton® seals)	°C [°F]	-30°~150° [-20°~300°]				
Actuation (open/close)	sec	0.20	0.25	0.35	0.50	0.70
Accuracy	mm [in]	±0.02 [±0.0009]				
Repeatability	mm [in]	±0.01 [±0.0004]				
Valve to Required Actuate Single Acting		3-way, 2-position				
Valve to Required Actuate Double Acting		4-way, 2-position				

2-Jaw Precision Parallel Grippers | Dimensions and Technical Specifications

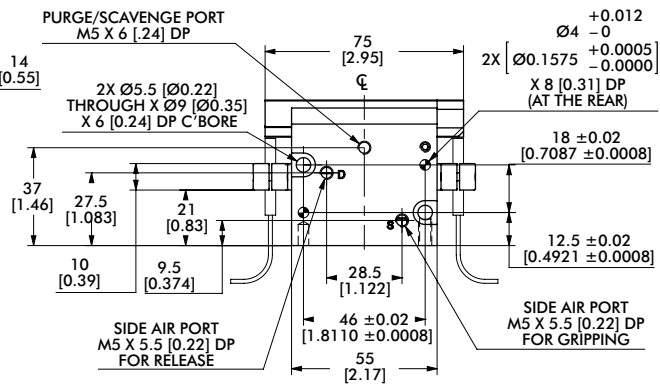
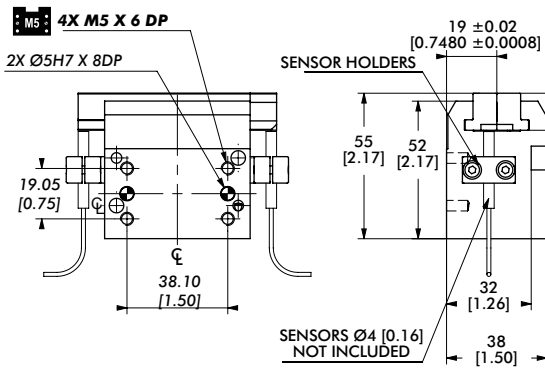
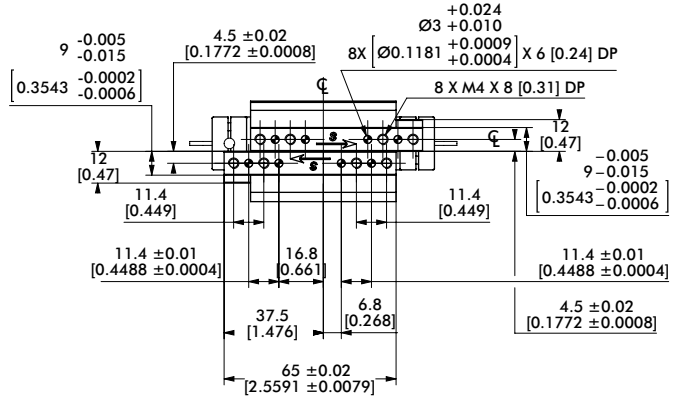
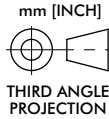
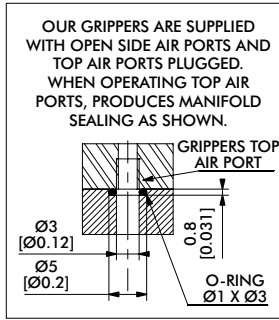

NOTE:

To benefit from safety springs power, on open or on close, gripper must always be operated with "S" for GRIPPING and with "D" for RELEASE.

Drawing hereafter shows gripper gripping at the end of stroke (inlet through "S")

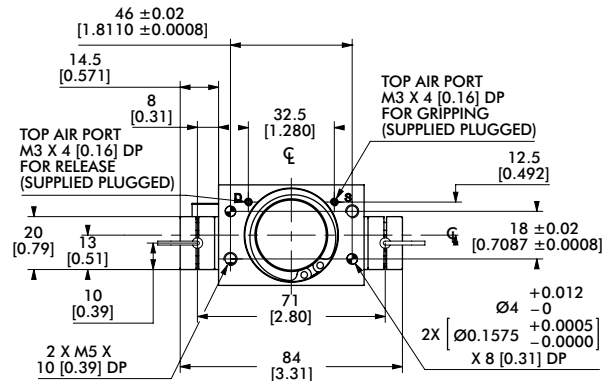

Seal Repair Kits	DGC-25
Buna-N Seal Repair Kit	SLKT-319
Viton® Seal Repair Kit	SLKT-319V

Loading Information

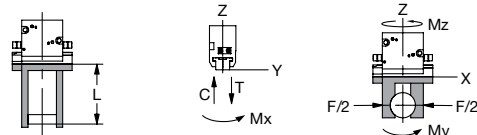
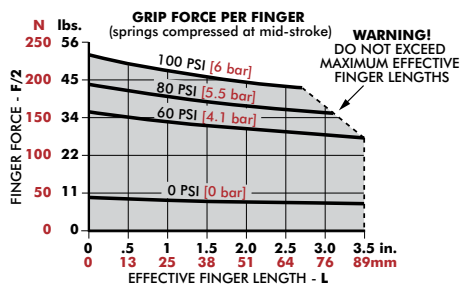

DGC-25	Static	Dynamic
Maximum Tensile T	125 N [28 lbs]	25 N [6 lbs]
Maximum Compressive C	145 N [33 lbs]	29 N [7 lbs]
Maximum Moment M_x	2 Nm [18 in-lbs]	0.5 Nm [4 in-lbs]
Maximum Moment M_y	4 Nm [35 in-lbs]	1 Nm [9 in-lbs]
Maximum Moment M_z	6 Nm [53 in-lbs]	1.5 Nm [13 in-lbs]

*Capacities are per set of jaws and are not simultaneous

2-Jaw Precision Parallel Grippers | Dimensions and Technical Specifications

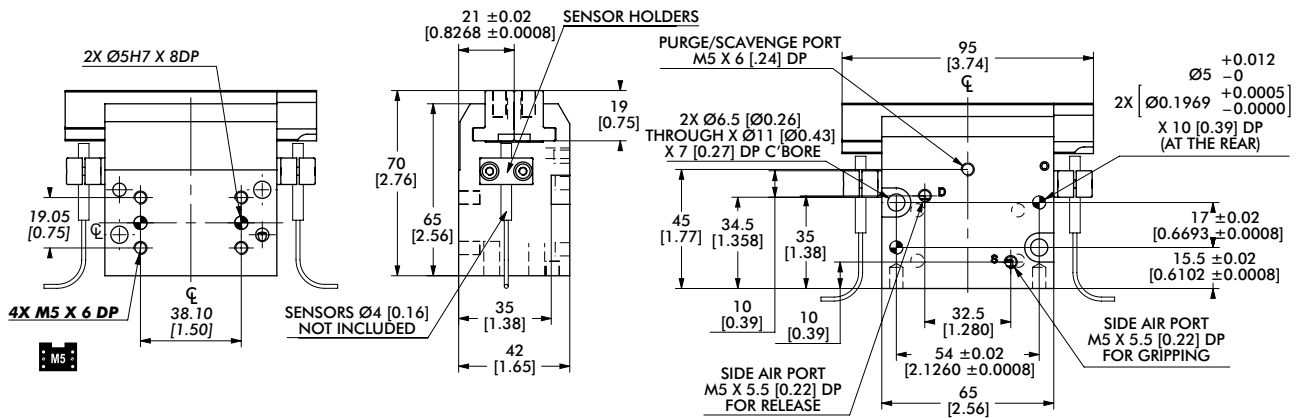
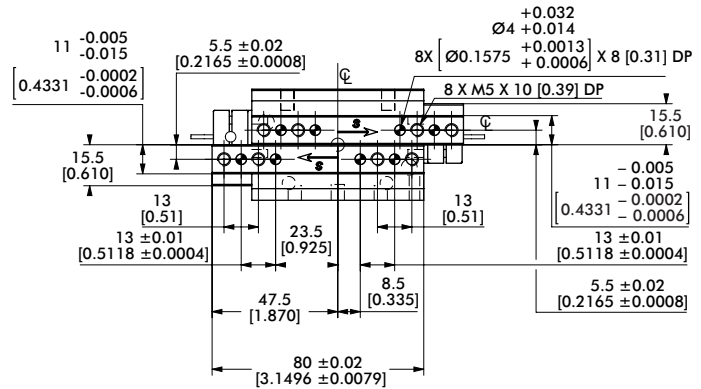
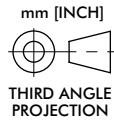
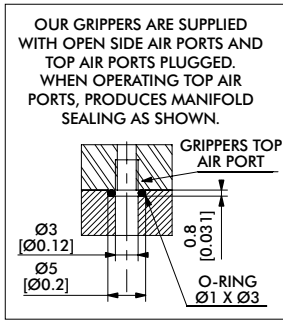

NOTE:

To benefit from safety springs power, on open or on close, gripper must always be operated with "S" for GRIPPING and with "D" for RELEASE.

Drawing hereafter shows gripper gripping at the end of stroke (inlet through "S")

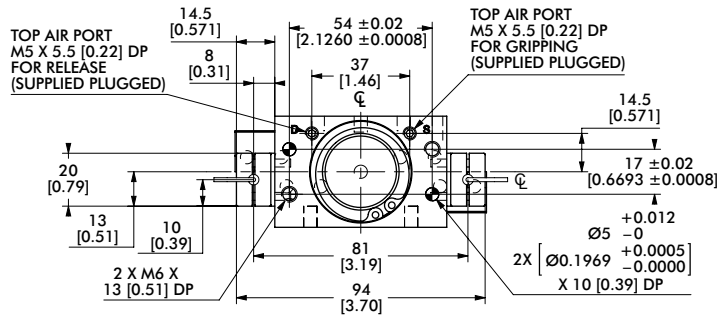

Seal Repair Kits	DGC-45
Buna-N Seal Repair Kit	SLKT-321
Viton® Seal Repair Kit	SLKT-321V

Loading Information

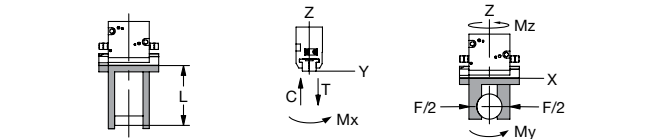
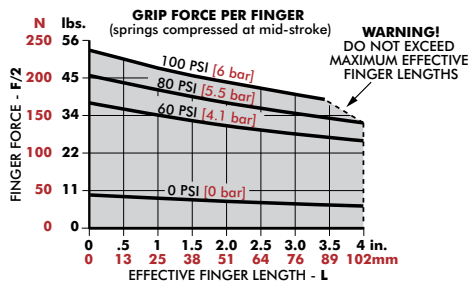

DGC-45	Static	Dynamic
Maximum Tensile T	205 N [46 lbs]	41 N [9 lbs]
Maximum Compressive C	225 N [51 lbs]	45 N [10 lbs]
Maximum Moment M_x	3 Nm [27 in-lbs]	0.75 Nm [7 in-lbs]
Maximum Moment M_y	6 Nm [53 in-lbs]	1.5 Nm [13 in-lbs]
Maximum Moment M_z	9 Nm [80 in-lbs]	2.25 Nm [20 in-lbs]

*Capacities are per set of jaws and are not simultaneous

2-Jaw Precision Parallel Grippers | Dimensions and Technical Specifications

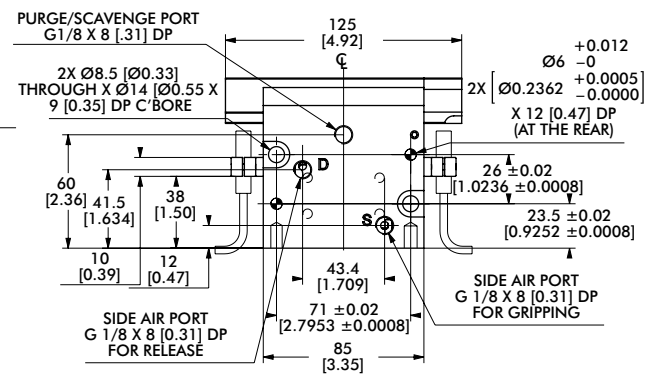
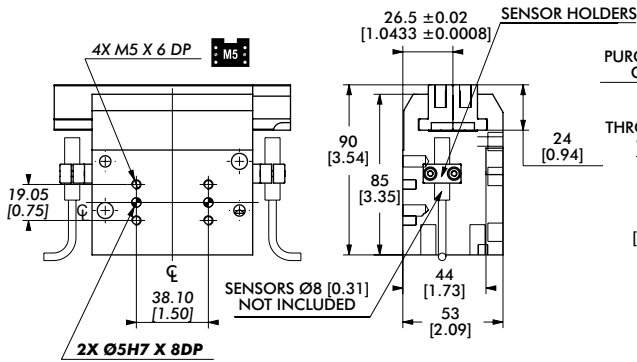
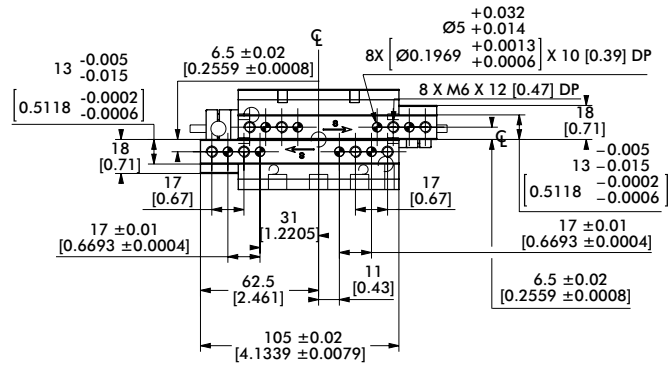
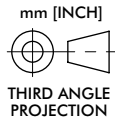
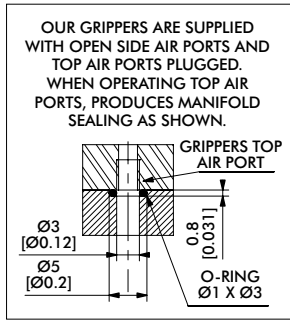

NOTE:
To benefit from safety springs power, on open or on close, gripper must always be operated with "S" for GRIPPING and with "D" for RELEASE.
Drawing hereafter shows gripper gripping at the end of stroke (inlet through "S")

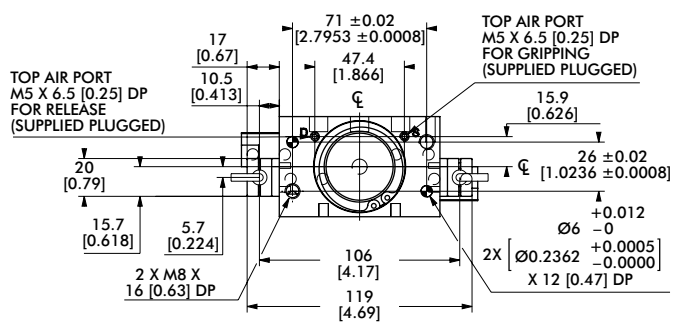

Seal Repair Kits	DGC-65
Buna-N Seal Repair Kit	SLKT-323
Viton® Seal Repair Kit	SLKT-323V

Loading Information

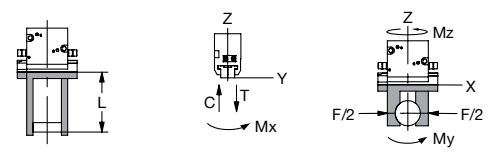
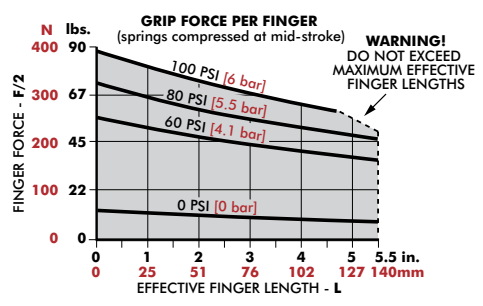

DGC-65	Static	Dynamic
Maximum Tensile T	270 N [61 lbs]	54 N [12 lbs]
Maximum Compressive C	305 N [69 lbs]	61 N [14 lbs]
Maximum Moment M_x	4 Nm [35 in-lbs]	1 Nm [9 in-lbs]
Maximum Moment M_y	10 Nm [89 in-lbs]	2.5 Nm [22 in-lbs]
Maximum Moment M_z	17 Nm [150 in-lbs]	4.25 Nm [38 in-lbs]

Capacities are per set of jaws and are not simultaneous

2-Jaw Precision Parallel Grippers | Dimensions and Technical Specifications

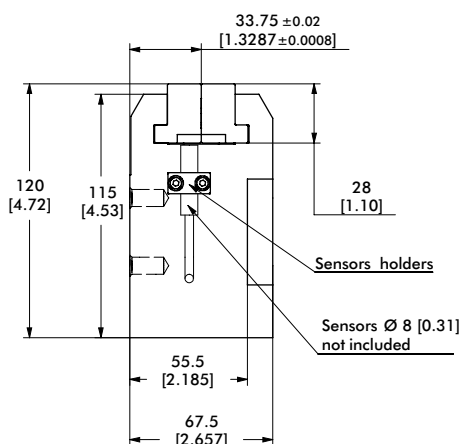
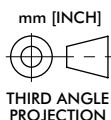
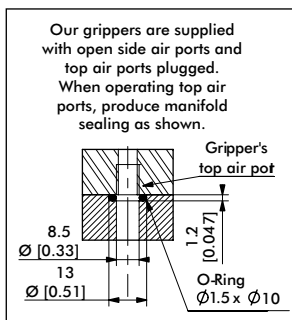

NOTE:

To benefit from safety springs power, on open or on close, gripper must always be operated with "S" for GRIPPING and with "D" for RELEASE.

Drawing hereafter shows gripper gripping at the end of stroke (inlet through "S")

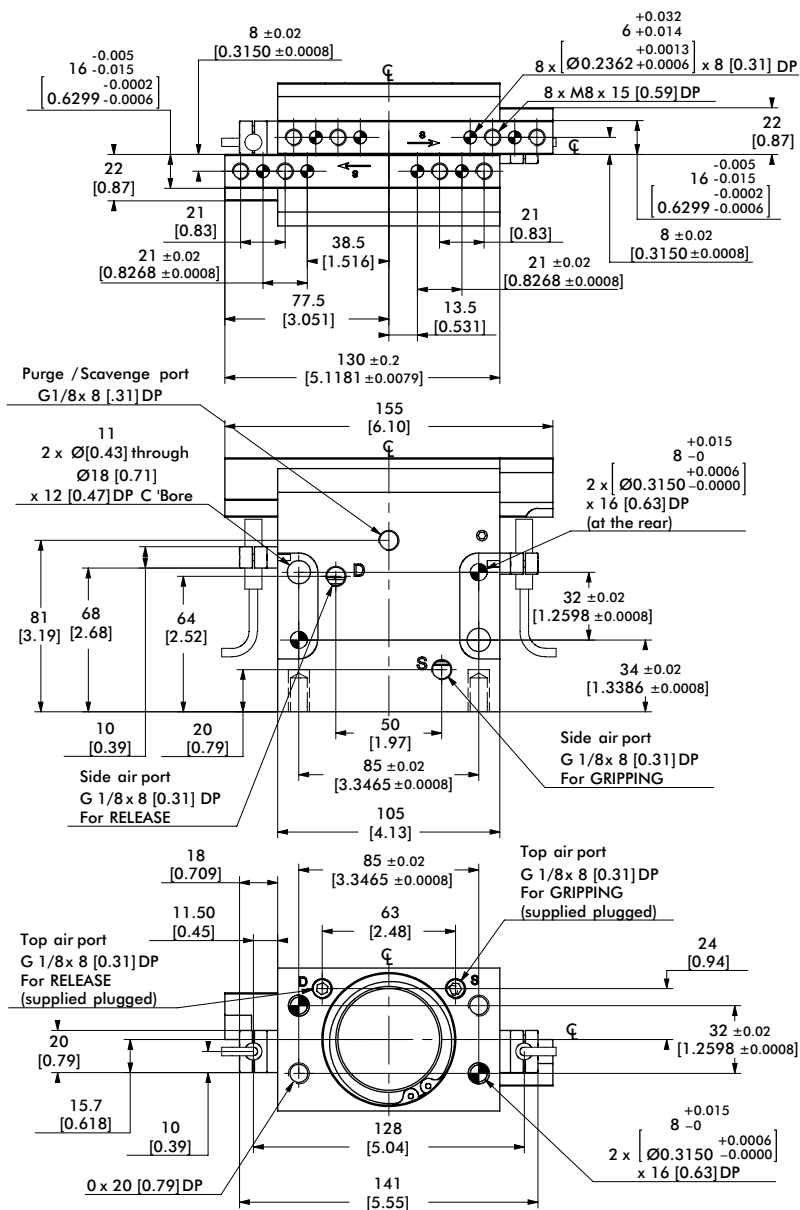

Seal Repair Kits	GC-85
Buna-N Seal Repair Kit	SLKT-325
Viton® Seal Repair Kit	SLKT-325V

Loading Information

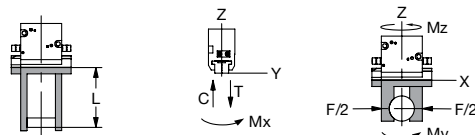
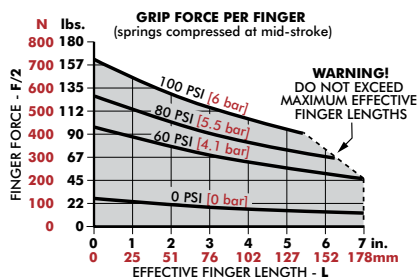

GC-85	Static	Dynamic
Maximum Tensile T	370 N [83 lbs]	74 N [17 lbs]
Maximum Compressive C	405 N [91 lbs]	81 N [18 lbs]
Maximum Moment M_x	6 Nm [53 in-lbs]	1.5 Nm [13 in-lbs]
Maximum Moment M_y	15 Nm [133 in-lbs]	3.75 Nm [33 in-lbs]
Maximum Moment M_z	27 Nm [239 in-lbs]	6.75 Nm [60 in-lbs]

*Capacities are per set of jaws and are not simultaneous

GC-105

2-Jaw Precision Parallel Grippers | Dimensions and Technical Specifications

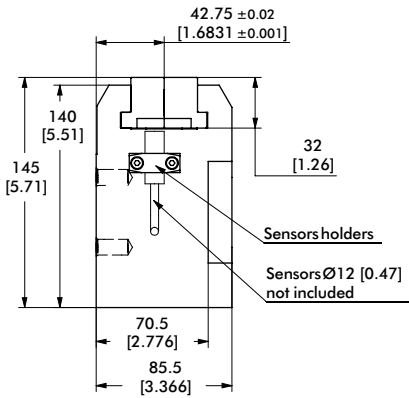
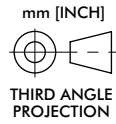
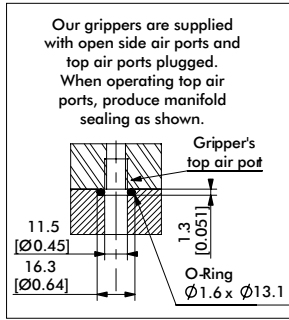

NOTE:

To benefit from safety springs power, on open or on close, gripper must always be operated with "S" for GRIPPING and with "D" for RELEASE.

Drawing hereafter shows gripper gripping at the end of stroke (inlet through "S")

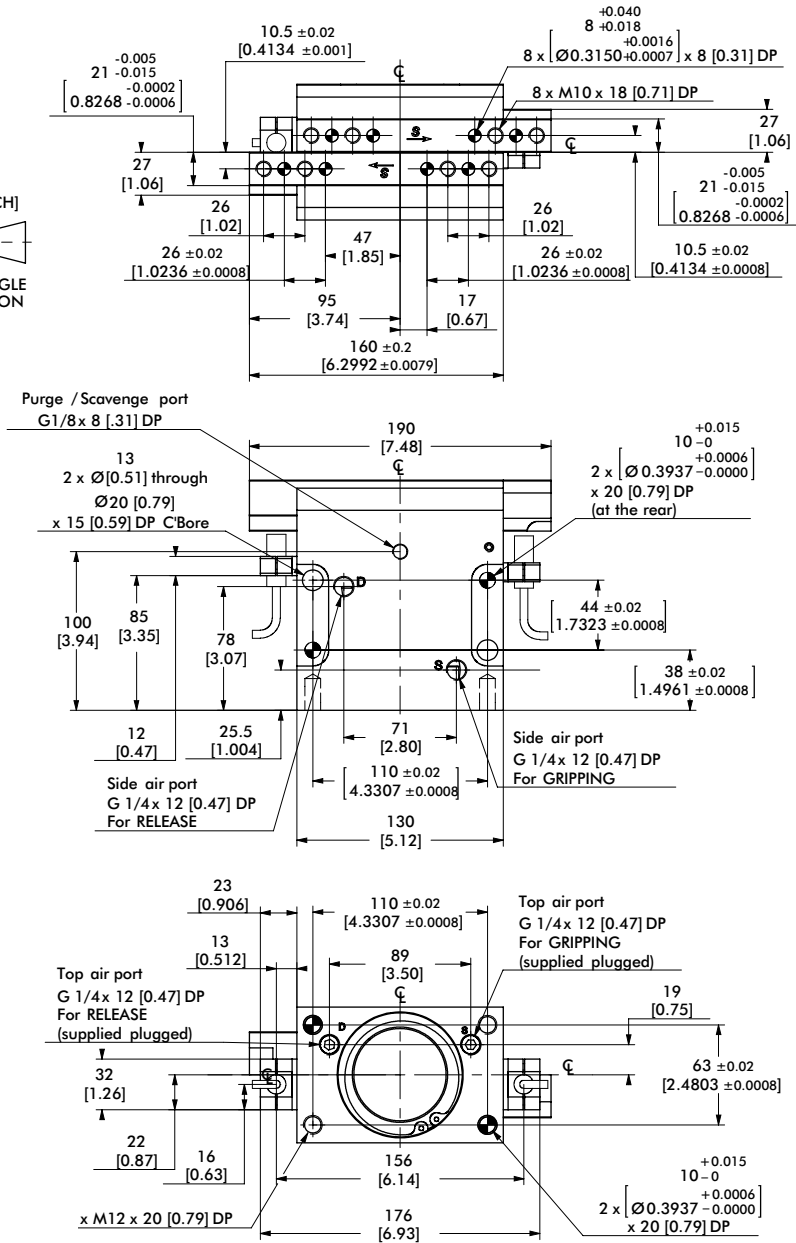

Seal Repair Kits	DGC-105
Buna-N Seal Repair Kit	SLKT-27
Viton® Seal Repair Kit	SLKT-327V

Loading Information

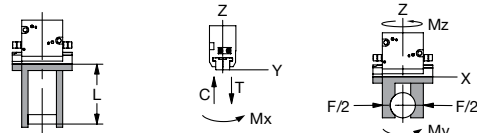
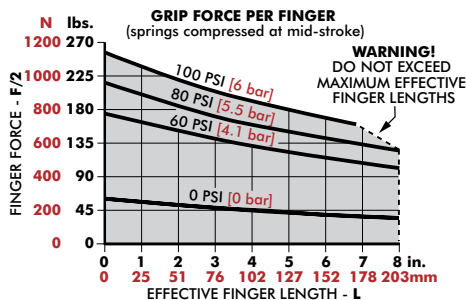

GC-105	Static	Dynamic
Maximum Tensile T	415 N [93 lbs]	83 N [19 lbs]
Maximum Compressive C	455 N [102 lbs]	91 N [20 lbs]
Maximum Moment M_x	8 Nm [71 in-lbs]	2 Nm [18 in-lbs]
Maximum Moment M_y	19 Nm [168 in-lbs]	4.75 Nm [42 in-lbs]
Maximum Moment M_z	40 Nm [354 in-lbs]	10 Nm [89 in-lbs]

*Capacities are per set of jaws and are not simultaneous