

Congratulations on your choice of a Real Good Toys product. Your kit has been precision made with meticulous care by our craftspeople using carefully selected materials. This Dollhouse will last for years, even generations, if heirloom care and attention is given during assembly. Take your time and read the instructions completely. If you have questions, ask the experts at your local Dollhouse store or at info@realgoodtoys.com

Before you begin - You have already opened the box and see all the parts organized in boxes and bundles. For the moment, keep them that way. There are important things to do before you open your glue bottle.

Choose your color scheme. Look at houses in your community, models in your local Dollhouse shop or at our website: realgoodtoys.com; look at plan books from a paint store or architectural books at your library (a favorite is: *Painted Ladies* by Michael Larsen and Elizabeth Pomada). You will be painting some of the parts right away so get the paint now. Choose high-quality semi-gloss latex enamel paints for ease of use and durability.

Prepare your space: This dollhouse will spread out over a large area while it is being built. You will need a large flat tabletop for the house, several boxes to keep parts organized until they are needed, and several trays lined with waxed paper for holding small parts like windows and railings. A snap-lid box will keep your tools and supplies handy between building sessions.

Measure and identify the parts: The kit is packed in groupings that protect the parts, and that is how the Parts List is organized. As you measure and identify the parts, label them with sticky notes using the names from the parts list, and check them off the parts list so you know you have everything. Taking the time now to identify and organize the parts also makes them familiar so you will understand what the instructions intend as you read ahead.

- Plan ahead so you know where you are going
- Read ahead so you know how to get there
- Paint ahead so the parts will be ready when you need them



Supplies:

Paint: Interior semi-gloss latex paint... Everything gets at least one coat before assembly - get the paint now.

Paintbrushes 1" or 2" foam brushes for each color, 3" foam roller for interior painting

Sandpaper: 320 grit, 3-5 sheets

Glue: Aleene's Tacky Glue for the dollhouse, Solvent-Based panel cement for shingles

Masking tape: 3/4" or 1"

Wiring: it's easiest to install some parts during assembly... order wiring supplies now.

Wallpaper paste: Roman's "Border" Paste

Not suitable for children under 13 years of age
California 93120 compliant for formaldehyde phase 2



www.realgoodtoys.help

Identify the parts: Open one bundle at-a-time. Measure each part and find it on the parts list. Label the parts and group them by the 'instruction section #' at the end of each part's name(#).

These groups are how the parts will be used.

Parts: (measurements are approximate and are for identification purposes only)

- (2) E9421 Front Wall¹: (Clapboard) 9³/₄ x 11¹/₄, doorway
- (3) E9415 Bay Floor¹: (3/8) 3 x 8, angled
- (2) E9437 Side Foundation¹: (3/8) 15¹/₂ x 1³/₄
- (1) E9429 Tower Back, Left³: (Clapboard) 3³/₄ x 9¹/₄, angled, bev.
- (4) E9422 Inset Wall¹: (Clapboard) 9³/₄ x 3¹/₂
- (2) E9417 Divider¹: (3/8) 9³/₄ x 12, doorway
- (1) E9441 Cutting Guide⁷: (3/8) 6⁷/₈± x 1⁷/₈, angle
- (4) E3617 Bottom Stair Blocks⁹: (6Step) 2¹/₄
- (1) E9413 Attic Front¹: (3/8) 13¹¹/₁₆^{tall} x 10¹³/₁₆^{base}, Oval Window
- (2) E9414 Gable Triangle³: (3/8) 4¹/₄^{tall} x 8¹/₂^{base} Triangle
- (1) E9431 Tower Back, Ctr³: (Clapboard) 4³/₄ x 7³/₈, angled, bev.
- (2) E9439 Porch Spacer¹: (3/8) 10¹⁷/₃₂ x 3¹/₂
- (2) E9420 Side Wall¹: (Clapboard) 20⁵/₈ x 15⁷/₈, grooved
- Big Box
- (1) E9432 Tower Ceiling⁵: (3/4) 11 x 8⁷/₈, angles, molded edge
- (1500) E9497 Shingles
- (1) E9447 Kneewall¹: (1/2 x 1/2^{triangle}) 18⁷/₈
- (1) E9448 Kneewall¹: (1/2 x 1/2^{triangle}) 15⁷/₈
- (1) E9416 Gable Floor¹: (3/8) 8¹/₂ x 3³/₈
- (1) E9408 Right Eave: (3/8) 13¹¹/₃₂ x 1
- (1) E9444 Front Step, Top^A: (5/8) 1 x 6
- (1) E9445 Front Step, Bottom^A: (5/8) 2 x 6
- (9) E9485 1/2" Stripwood⁷: (1/2 x 3/32) ~20¹/₂
- (1) E9403 Tower Roof Face⁵: (1/4) 11 x 5⁵/₈^{base}, angled, bev.
- (4) E9402 Tower Roof Corner⁵: (1/4) 11 x 4⁵/₈^{base}, angled, bev.
- (1) E9404 Tower Roof Spacer⁵: (1/4) 7³/₈ x 5⁵/₈^{base}, angled, bev.
- (1) E9406 Left-top Eave: (3/8) 8 x 1, miters
- (2) E9409 Gable Roof³: (3/8) 7¹/₂ x 4, bev.
- (1) E9418 Attic Divider¹: (3/8) 10¹/₁₆ x 15¹/₂ Bev, doorway
- (1) E9419 Porch Edge^A: (1/4) 14⁵/₁₆, x 3/8
- (2) E9438 Foundation Spacer¹: (3/8) 8⁷/₁₆ x 1³/₄
- (1) E9525 Step Back^A: (1/4) 7¹/₄ x 1³/₄

- (1) E9401 Right Roof²: (3/8) 20⁷/₈ x 16⁷/₈, bevel
- (1) E9400 Left Roof²: (3/8) 20⁷/₈ x 16⁷/₈, bevel, cutout
- (1) E9412 Mid Floor¹: (3/8) 27 x 15⁷/₈, stair hole
- (2) E9436 Middle Foundation¹: (3/8) 18 x 1³/₄
- (1) E9411 Top Floor¹: (3/8) 27 x 15⁷/₈, stair hole
- (1) E9433 Front Foundation¹: (1/2) 23¹/₂ x 1³/₄, bevells
- (1) E9435 Back Foundation¹: (1/2) 27 x 1³/₄, notches
- (1) E9410 Base Floor¹: (3/8) 27 x 18⁷/₈, angles

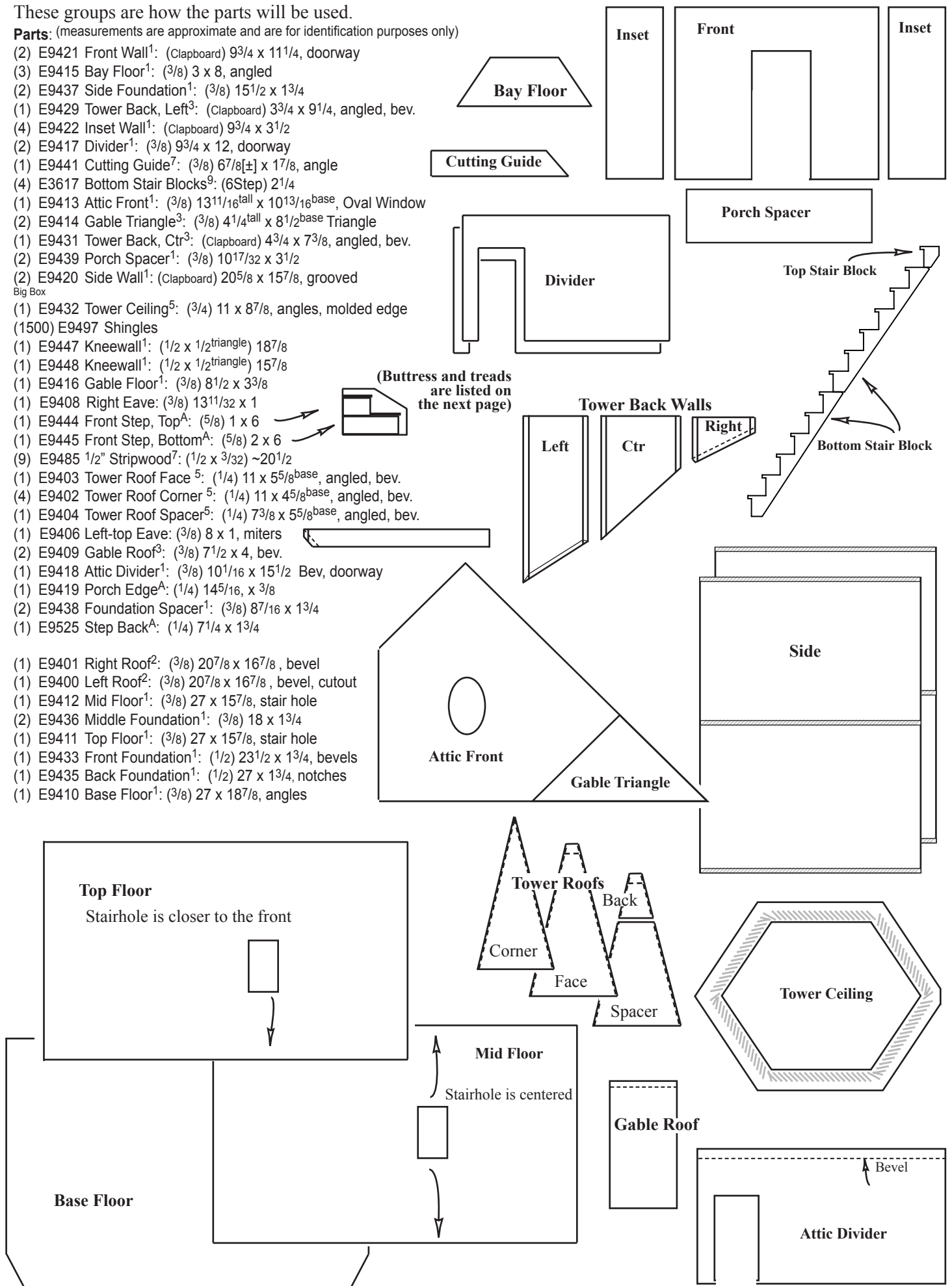

Drawings are not all the same scale

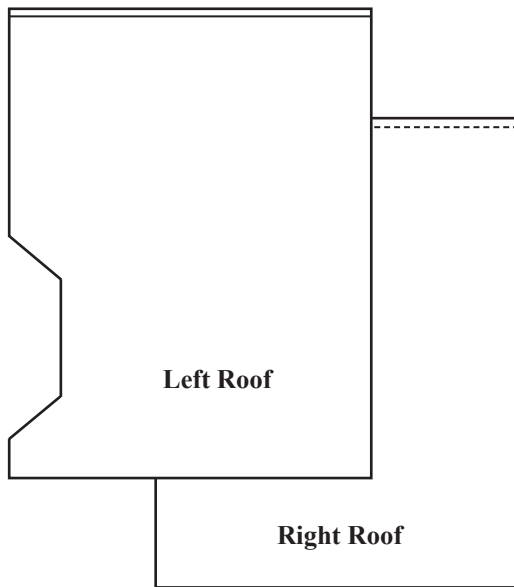

- (1) E9407 Left-bottom Eave: (3/8) 2³/₁₆ x 1, miters
- (1) E9465 Nosing, Left-Bottom Roof: (1/2 x⁹/₁₆ molding) 2¹/₂, miter
- (1) E9463 Nosing, Right Roof: (1/2 x⁹/₁₆ molding) 13¹/₂, miter
- (1) E9464 Nosing, Left-Top Roof: (1/2 x⁹/₁₆ molding) 8⁵/₈, miters
- (1) E9467 Nosing, Gable Left Roof: (1/2 x⁹/₁₆ molding) 7⁵/₈, miter
- (1) E9466 Nosing, Gable Right Roof: (1/2 x⁹/₁₆ molding) 7⁵/₈, miter
- (1) E9468 Nosing, Gable Base: (1/2 x¹/₂ molding) 9¹/₂, miters
- (1) E9469 Cornice, Porch Ceiling: (1 x³/₄ molding) 11¹/₂, miters
- (1) E9470 Cornice, Balcony Ceiling: (1 x³/₄ molding) 10⁷/₈, miters
- (1) E9471 Attic Tabling Trim (5/8 x⁹/₁₆ molding) 8³/₄, miters
- (1) E9472 Attic Crosspiece: (5/8 x⁹/₁₆ molding) 11³/₄, miters
- (1) E9473 Gable Crosspiece: (5/8 x⁹/₁₆ molding) 6¹/₄, miters
- (2) E9489 Balcony Rail⁹: (5/16 x⁵/₁₆ molding) 10¹¹/₃₂
- (2) E9490 Arch Rail⁹: (5/16 x¹/₄ molding) 10¹⁷/₃₂
- (1) E9474 Window Ledge 5⁵/₈, miters
- (2) E9475 Window Ledge 4⁵/₈, miters
- (2) E9456 Stringer^A: (3/8 x⁵/₁₆) 12", //angles

- (40) E9009 3/8 Beads⁹

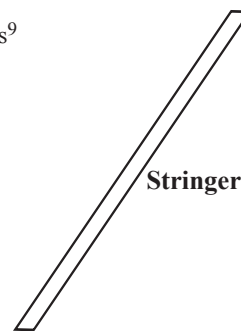

Cross sections

Window Horizontal Frames (7/16 x⁵/₁₆ molding)

- (20) E9461 3¹/₂ miter 45°/45°
- (40) E9462 2¹/₂ miter 45°/45°

Window Vertical Frames (7/16 x⁵/₁₆ molding)

- (24) E9459 5³/₄ miter 45°/45°
- (12) E9460 4³/₄ miter 45°/45°

Window Vertical Frames (7/16 x⁵/₁₆ molding)

- (24) E9458 6³/₄ miter 45°/45°

- (2) 6002 Door with Interior Trim (see page 34)

Box

- (1) 2019 Oval Window

Raised Panels⁸: (1¹/₂ x¹/₈ molding)

- (1) E9479 1¹/₂" Raised Panel: 3¹/₄
- (2) E9480 1¹/₂" Raised Panel: 2¹/₄
- (2) E9481 1¹/₂" Raised Panel: 3¹/₄
- (4) E9482 1¹/₂" Raised Panel: 2¹/₄

Pilaster: (3/4 x³/₁₆ molding)

- (4) E9477 1¹⁷/₃₂
- (3) E9478 1¹/₈
- (2) E9476 4³/₄

Cross sections

Bay Walls (Clapboard)

- (3) E9423 Front Mid¹: 3³/₈ x 4³/₄, groove, bev.
- (6) E9424 Side Mid¹: 3³/₈ x 3³/₄, groove, bev.
- (2) E9425 Front Base¹: 1⁷/₈ x 4³/₄, groove, bev.
- (2) E9426 Side Base¹: 1⁷/₈ x 3³/₄, groove, bev.
- (2) E9427 Front Top¹: 1¹/₂ x 4³/₄, bev.
- (6) E9428 Side Top/Base²: 1¹/₂ x 3³/₄, bev.

Bay Walls

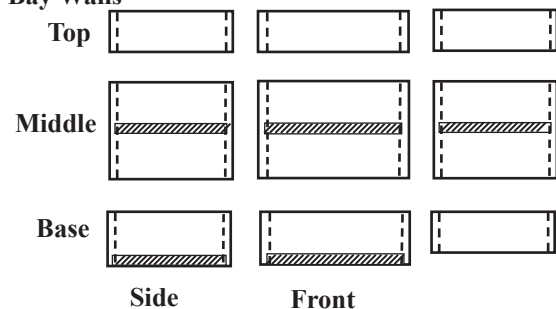

- (1) E9491 Window Pane (Printed) 4³/₈ x 3¹/₈
- (2) E9492 Window Pane (Printed) 5³/₈ x 3¹/₈
- (2) E9493 Window Pane (Printed) 6³/₈ x 3¹/₈
- (2) E9494 Window Pane (Printed) 4³/₈ x 2¹/₈
- (4) E9495 Window Pane (Printed) 6³/₈ x 2¹/₈
- (4) E9496 Window Pane (Printed) 5³/₈ x 2¹/₈

Stripwood stock is bundled for total yield... counts and lengths may vary

- (2) E9483 1" Stripwood¹: (1 x 1/8) ~18
- (2) E9484 3/4" Stripwood⁷: (3/4 x 3/32) ~18
- (3) E9487 3/16" Stripwood⁶: (3/16 x 3/32) ~18
- (5) E9488 1/8" dowel⁶: ~18

Cross sections

- (10) E9457A Bay Vertical, Corner⁹: 6³/₄
- (10) E9457B Bay Vertical, Side⁹: (3/8 x³/₄ molding) 6³/₄

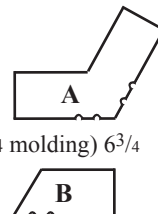

- (7) E9449 Window Block⁴: (3/8) 1/8 x 3⁵/₁₆
- (14) E9450 Window Block⁴: (3/8) 1/8 x 2⁵/₁₆
- (2) E9451 Window Block⁴: (3/8) 1¹/₈ x 3⁵/₁₆
- (4) E9452 Window Block⁴: (3/8) 1¹/₈ x 2⁵/₁₆
- (1) E9453 Window Block⁴: (3/8) 2¹/₈ x 3⁵/₁₆
- (2) E9454 Window Block⁴: (3/8) 2¹/₈ x 2⁵/₁₆

- (2) E9455 Top Stair Blocks⁹: (1Step) 2¹/₄
- (1) E9440 Stairhole Glueblock¹: (3/8) 2¹/₄ x 1/4
- (1) E9430 Tower Back, Right³: (Clapboard) 3³/₄ x 2⁷/₈, angled, bev.
- (2) E9443 Front Step, Buttress^A: (5/8) 2³/₁₆ x 1¹¹/₁₆, angled,
- (2) E9434 Corner Foundation¹: (1/2) 3¹/₂ x 1³/₄, bev.
- (1) E9405 Tower Roof Back⁵: (1/4) 3¹/₂ x 2⁷/₁₆^{base}, angled, bev.
- (2) E9442 Front Spacer¹: (1/8) 7³/₄ x 1
- (2) E9446 Front Step, Tread^A: (1/8) 1¹/₈ x 6
- (1) Tower Ceiling Groove Fill⁵: (1/4 x 1/8) 7¹³/₁₆.

Options for building the Victorian Painted Lady Dollhouse

Exterior:

Exterior Paint Color:
see www.realgoodtoys.help for suggestions

Accessories:

- Gingerbread
- Flower Boxes
- Foundation Stucco Grit
- Octagonal Shingles
- Fancy Windows and Doors
- Turnposts and Spindles

Interior:

- Wiring
- Wallpaper
- Interior paint color:
- Ceilings
- Painted walls
- Interior trim

Flooring:

- Faux-wood finish (do it now)
- Applied wood, tile, or carpet
- Painted floors

Banister & Landing Rails

- Window and Door trim
- Baseboard and Crown

Doors:

Exterior

Interior



#6018



#6022



#1015



A Doghouse for your Dollhouse

Note: I often enlarge an interior door opening to fit the #6022

Trim and Stripwood



Flute24



SW16



RGT8

Split Octagonal Shingles



Shingle Dye



Dye1: Reddish Brown
Dye3: Dark Grey



Real Good Toys' *Best1 Plus* Dollhouse Wiring Set

visit www.realgoodtoys.help for demos, slideshows, and suggestions for your build.

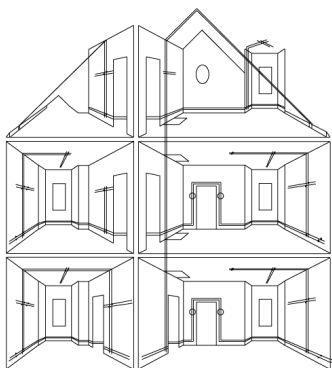

Wallpaper



P2000
HH444

Turntables, Decked Turntables, and Turntables with wiring feed are available



T-10
Turntable



6803 Banister & Landing Set

Assembly Notes:

A large, clutter-free, well-lighted work area is helpful during assembly, but a flat work surface is essential.

Read the instructions carefully; look at each of the illustrations. **!With the parts in your hands!**, think the assembly through before you proceed.

Test fit each time you are ready to glue a piece in place...then you'll know you have it right.

If more tape or a helper is needed, it's good to know that before the parts have glue on them.

Don't be stingy with glue or tape; use generous amounts. Always wipe off excess glue immediately.

Keep one damp rag and one dry rag handy all the time.

Have weights available for holding things tight as glue joints dry (stacks of books, gallons of pure Vermont Maple Syrup - anything heavy)

Glue the body of your dollhouse together with white, water clean-up glue that dries clear. Do not use instant-bond (super glue), fast-tack, rubber cement, silicone, or hot melt glues. They are all used in some wood applications, but they all have some characteristic that makes them un-desirable for the body of your dollhouse. Carpenter Glue works well, but glue-smear dries yellow or tan; many of the things you glue onto the house are pre-painted – extra glue will show. I use Aleene's Tacky Glue® for all house body assembly.

Make sure everything is straight and flat as glue dries... That's the shape that will be permanent.

Glue the shingles on with glue that doesn't have any water in it! If the glue says "water clean-up", it will curl the wooden shingles. Look carefully at the glue you intend to use to be sure it is solvent-based, or use hot-melt glue (and watch out for the burns). I use Liquid Nails #LN-601® glue which comes in a caulking-gun tube at the hardware or building supply store (note – Liquid Nails® also makes #990 which is "water clean-up" and will curl the shingles). Check ingredients and warnings! Solvent-based glues say "Caution, Flammable".

If you Wallpaper, use Roman's® "Border" paste, Brush paste on the wallpaper, then the wall, and then smooth the wallpaper into position.

When glue is drying, skip ahead to up-coming assembly steps and prepare the parts that will be used

OnLine Support: There are many photos of this Dollhouse under construction as well as tips, techniques, and extra help with your dollhouse project at: www.realgoodtoys.help

A: Getting Started: Do these things before the house assembly

Square the corners of the stair holes with a utility knife or coarse file - each cutout has a rounded corner left over from the tool that made it. Make two cuts in each corner from the top (one from each direction), then cut from each direction on the bottom to cut away the rounding in the corner so the stairs or glueblock will fit.

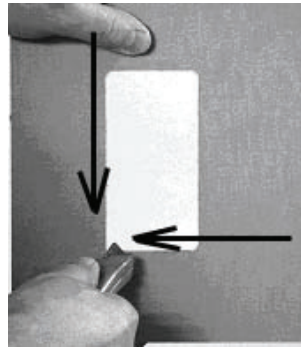

Stain the Shingles: Our pro uses Real Good Toys' Shingle Dye (available from Real Good Toys or your local miniature dealer) when dyeing the shingles for this house. Batch dye or stain the shingles several days ahead of time so they will be dry when the time comes to use them (instructions are with the shingle dye or www.dhbuilder.com).



Flooring: Applied hardwood flooring, carpeting, tile, or paint is applied after assembly is complete. Faux-wood flooring is done before assembly (Google "Faux Wood Floor on MDF gpr01010" for a YouTube video).

www.dollhouseworkshop.net/floorfinish

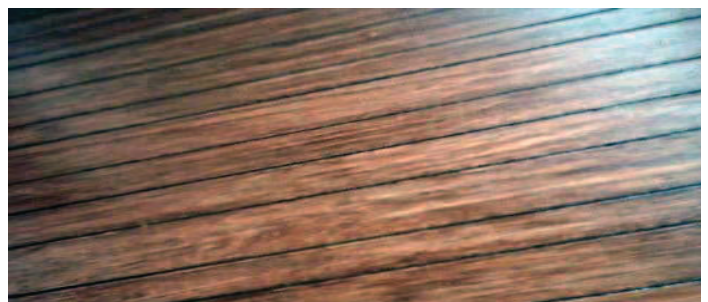

Painting: www.RealGoodToys.help has painting and sanding videos

A word about primer: Primer is designed to help paint stick to an impervious surface or to join layers of dissimilar paints. In *this* application, the first coat of paint soaks right into the wood and fills the grain - you *could* do that with primer, but its job of being an interface between different materials doesn't apply here. In *this* application, primer just adds steps and expense. I don't use it here and don't suggest it.

Paint the parts the first coat. The first coat mostly soaks into the wood, filling and reinforcing the grain so the sanding step clips off the fibers and leaves the surface smooth. Resist sanding before painting - it will leave the surface fuzzy and make a smooth finish harder to achieve. The quality of your final finish is dependent on the quality of the sanding after the first coat. Do not go back to re-paint just because the paint has soaked in. Just a bit of paint left on the surface tells you you have put on enough to saturate the grain, which is the right amount. More paint than that will only make sanding harder.

Glue doesn't stick to paint. Avoid painting edges, grooves, and areas that will be glued.

Paint the walls on both faces. Paint the upper floors on the bottom face (the ceilings).
Paint the Trim on one face and both edges.

Sand everything. Sand until the paint is smooth and "soft" feeling, transparent, and some of the wood is showing through. Sand the Clapboard one-clapboard-surface-at-a-time. Fold the sandpaper and sand back and forth until the surface of that board is smooth and transparent; then move on to the next board. Fold the sandpaper as needed to keep it fresh.

Paint the second coat. The Second coat for the outside of the Walls may be done after assembly of the housebody (that's what I do). The second coat goes on smooth and creamy with enough paint on the brush so it is quiet while you are brushing the paint out, but not enough to leave puddles or drips.

Clean the edges and grooves before assembly. A little paint always builds-out the corner of an edge or groove and will make assembly harder and the glue joint less strong. Test the Floor, Liner, and Back in their grooves to see that they fit well.

Do not stack painted parts - even when they feel dry they will stick and damage each other. Keep them spread out or separate them with waxed paper.

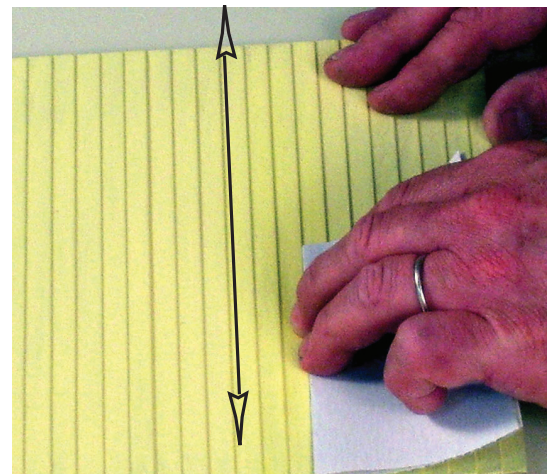
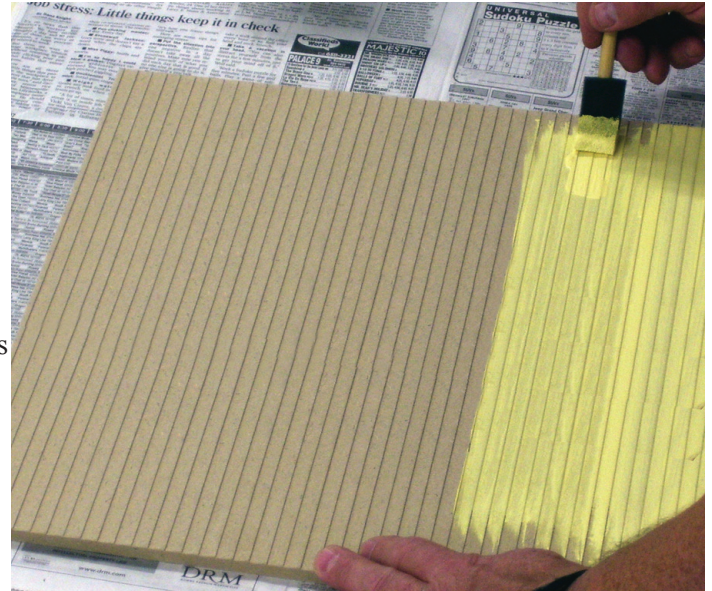

Cleaning a groove with a Cabinet Scraper



the back edge

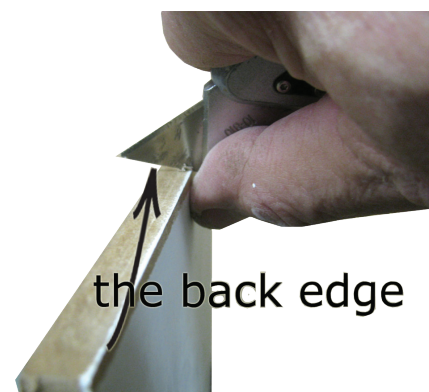

Cleaning an edge with the back of a utility knife blade

B: Paint all the walls now including the Attic Front and one Gable Triangle.
Do not paint the edges.

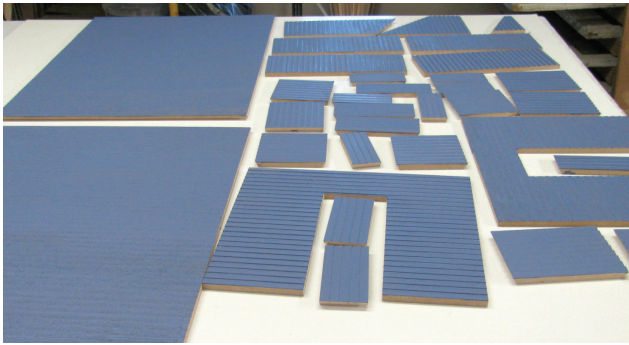

Paint the overhangs on the bottom of the Roofs

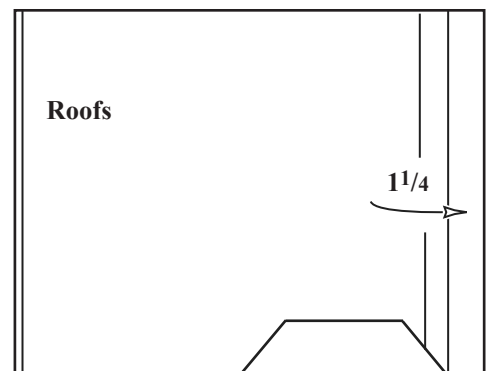
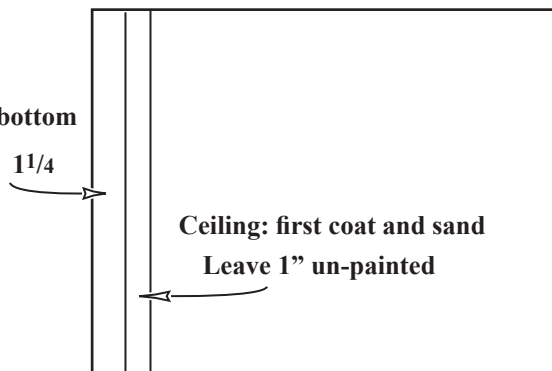

Paint the underside of the Eaves

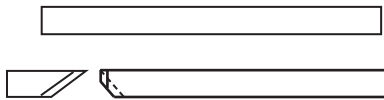

The dotted lines show a bevel that is facing away from you

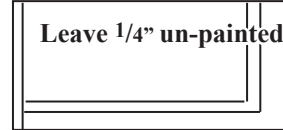
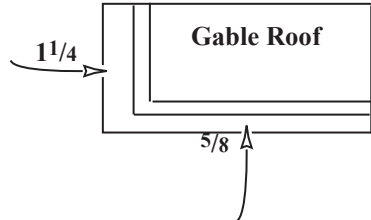

Trace a Bay Floor onto the bottom of the Gable Floor. Trace again with a 3/16" spacer (a Pilaster up on edge).

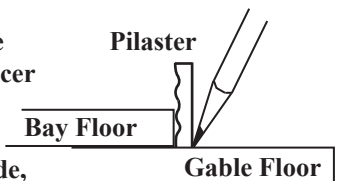

Paint to the Pilaster tracing on the outside, and to the Bay Floor tracing on the inside if you are painting the ceiling.

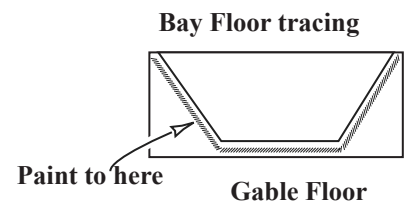

Paint the edges of the Tower Ceiling to the groove on top and 3/16" from the ceiling underneath

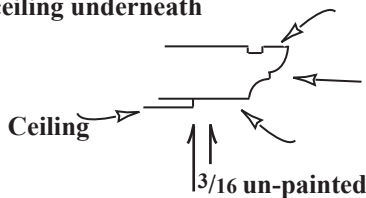

Anything that will be painted on the inside of the house can be first-coated and sanded now, while the panels are flat on the table. Sanding before assembly leaves some of the wood showing for the glue to grab (glue doesn't stick to paint), and allows a good

thorough sanding job for a smooth final finish. If you don't know whether you will paint, or you don't know the color, use white or primer for the first coat. Second-coat the interior paint after assembly.

Sand everything until the paint is smooth and transparent with the wood showing thru. Sand the clapboard *one course at a time*, with a folded piece of sandpaper. After a few courses, refold the sandpaper to keep the cutting action fresh.

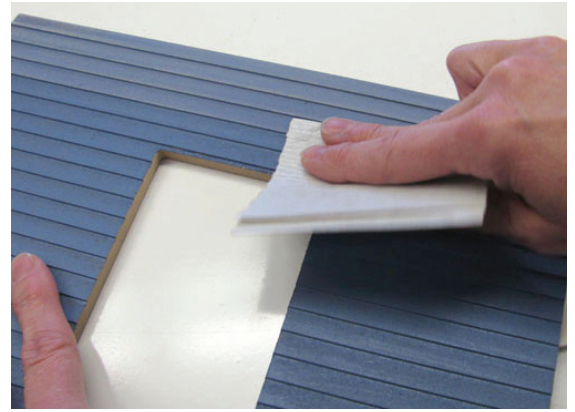

C. Build the Front Steps after the first-coat and sanding.

1. Glue together the Front Step, Bottom and the Front Step, Top, lined up in back.

Glue on the Buttrisses, also lined up in back. This is now the "Front Step Base".

2. Second-coat the Front Step Base and Treads. If you intend to texture-paint the Front Step Base, wait until the Treads are attached, and texture-paint close-to but not touching the Treads.

Texture Paint: For the foundations and anywhere else a textured surface is desired, base coat the surface with plain paint and second-coat with a mixture of paint and "Real Good Toys" Stucco Grit (www.realgoodtoys.com or your miniature store). Mix the Stucco Grit with paint and apply in slaps or short swirls

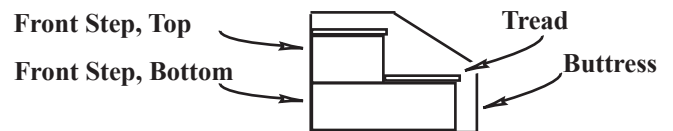
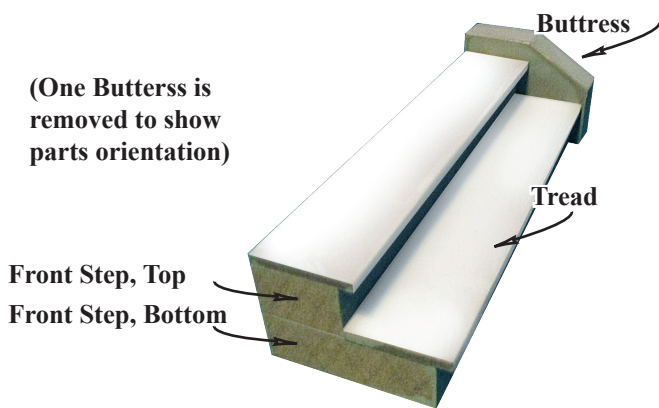

Re-paint. The second coat goes on smooth and creamy, with plenty of paint (but no puddles). Sometimes a third coat is necessary.

Do not second-coat Window Frames or Railing parts until they are glued together later on. Most interior painting should be second-coated after assembly.

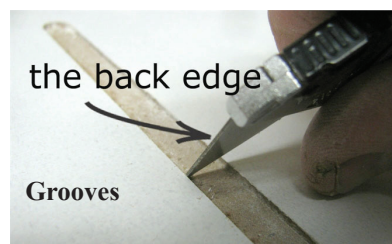
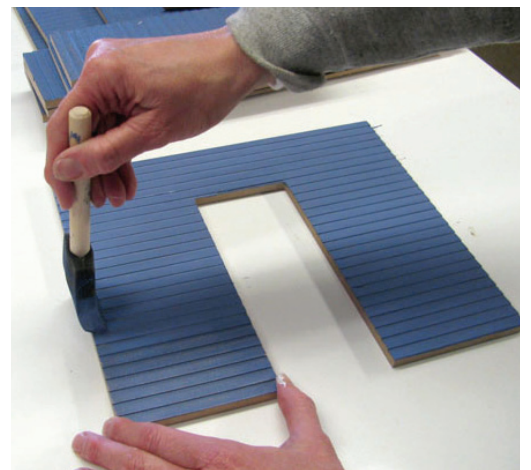

Clean excess paint from edges and grooves. Any amount of paint on edges and the lip of the grooves will make assembly difficult and interfere with the fit and strength of a joint. Use the back edge of your utility knife to remove the extra paint and test all joints before beginning assembly. Inspect and clean the beveled ends of all the Bay Walls.

Prepare the Floors:

1. The Base Floor will be used to exactly locate the Bay Floors on the Middle Floor and Top Floor. Protect the Base Floor with waxed paper from the glue (Illustration #1).

2. Lay the Middle Floor on the Base Floor with the stairhole closer to the right edge (the Middle Floor's stairhole is centered front-to-back). (Illustration #2). Prepare flaps of tape for holding the Bay Floors tight; the tape is stuck to the bottom of the Middle Floor. Line up the Middle Floor with the edges of the Base Floor.

3. Glue and tape the Bay Floors to the Middle Floor, carefully lined up on the angled edges. Stretch the tape under the Bay Floors, fold it over the top, and stretch it again to hold tight across the bottom and the top. (Illustration #3)

Check several times around the outside of the floors that the Middle Floor/Bay Floors line up with the Base Floor.

4. Glue the Stairhole Glueblock inside the Stairhole as shown, with the 3/8" thickness up-and-down (the same thickness as the floor)

Let the glue set for several minutes before moving the Middle Floor so the Bay Floors won't slip. When you do move the floor, clean up the glue with a damp rag and then a dry rag but be gentle! Replace the Waxed paper with a fresh piece for the Top Floor/Bay Floor assembly

5. Set the Top Floor on the Base Floor with the stairhole closer to the front and right edge. (Illustration #4)

Glue and tape a Bay Floor to the left edge only of the Top Floor, lined up carefully with the edges of the Base Floor.

Illus. #1

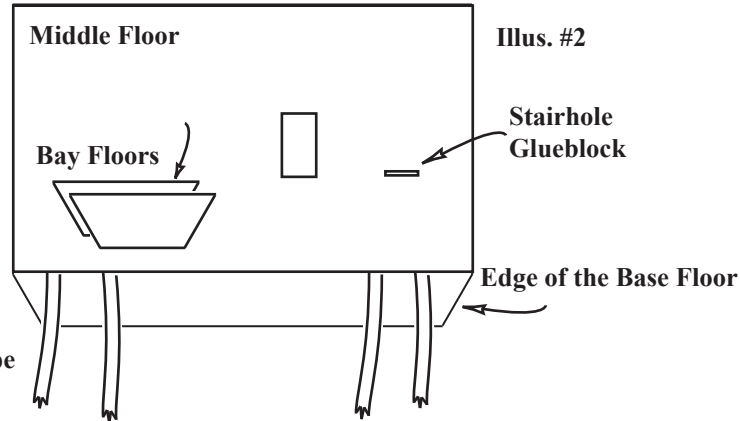
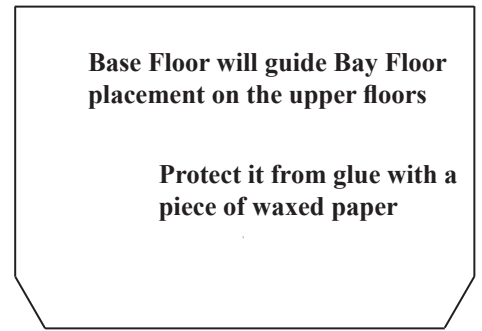

Illus. #3

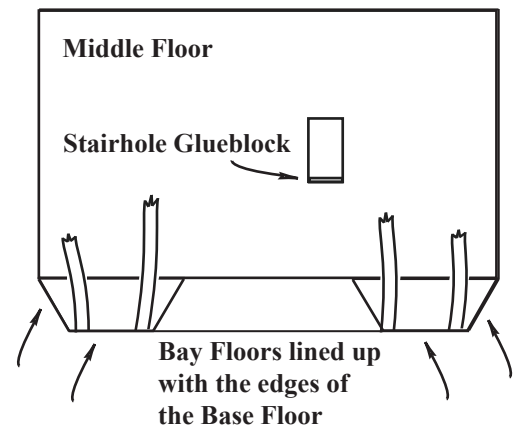

Illus. #4

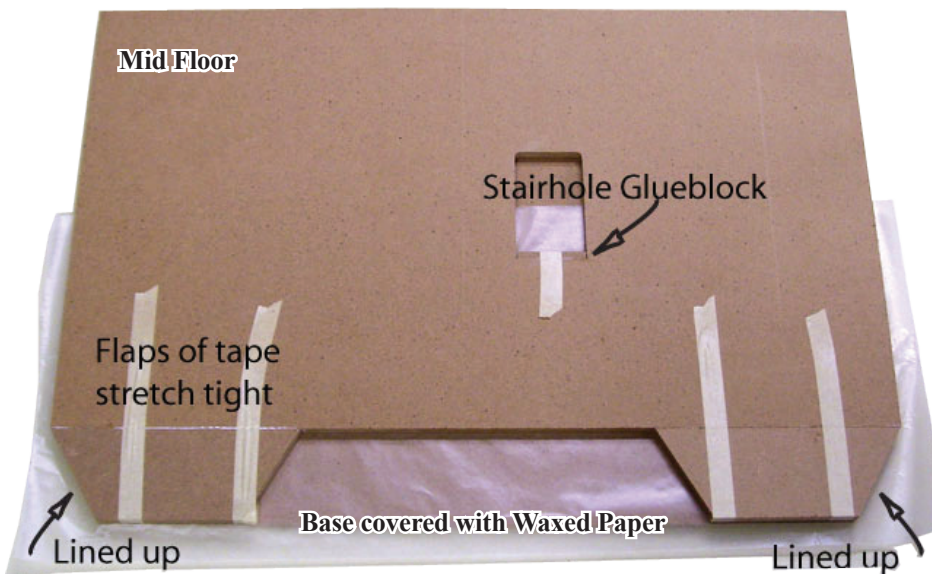
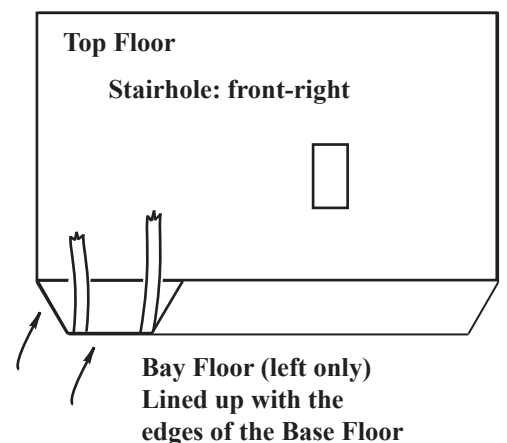

Let the glue dry

Assemble the Front Sets (Front Wall and Inset Walls)

6. **Tape together** (no glue) two Inset Walls and two Porch Spacers (the spacers are between the Inset Walls). Spread glue on the edge of the Inset Walls only.

Glue and tape the Front Wall to the Inset Walls, lined up top-and-bottom". When the glue is dry, remove the Spacers and use them to assemble the second Front Set. (Illustration 5)

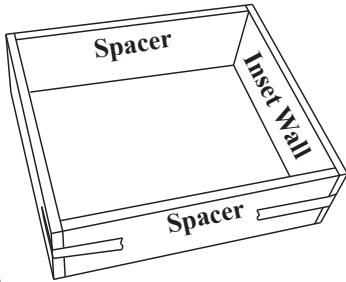

Illustrations #5
The "Spacers" are temporary

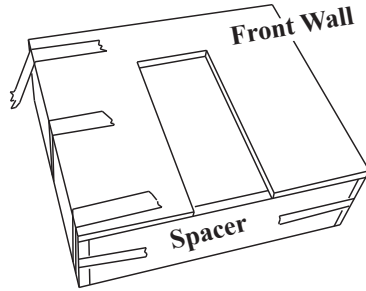

The Clapboard faces into the porch

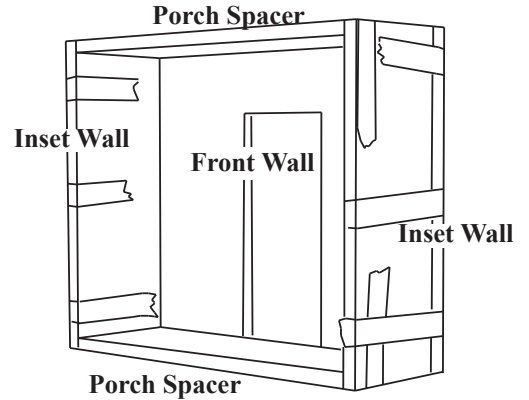

The Clapboard faces in and down on all three walls!

Assemble the Base (the Base Floor and Foundation)

7. **Glue and tape the Foundation Back (27")** and Sides (15 1/2") together and to the Base Floor, Tight in the Grooves and lined up at the edges. (Illustration #6)

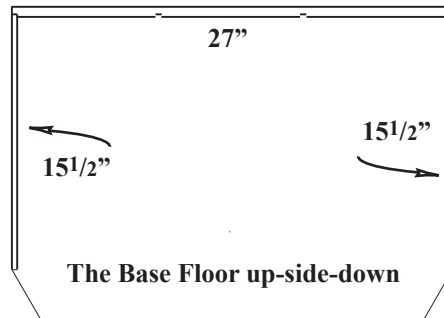

Illus. #6
Foundations

8. **Glue and tape Foundation Spacers (8 7/16")** to the Foundation and Base Floor as shown. (Illustration #7)

Illus. #7
Foundation Spacers

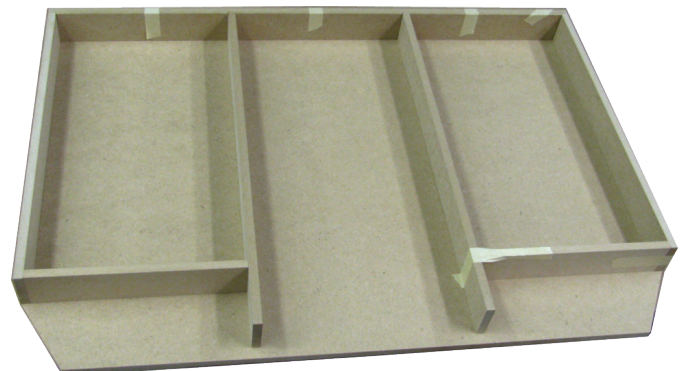
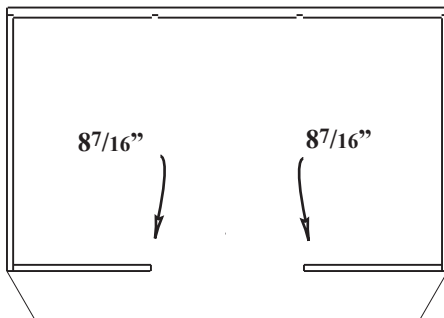

9. Glue Middle Foundations (18") to the Foundation and Base Floor as shown. (Illustration #8)

Illus. #8
Middle Foundations

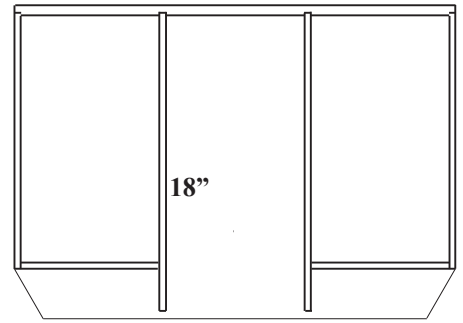

10. **Tape together** the Corner Foundations and the Front Foundation with the bevels face down.

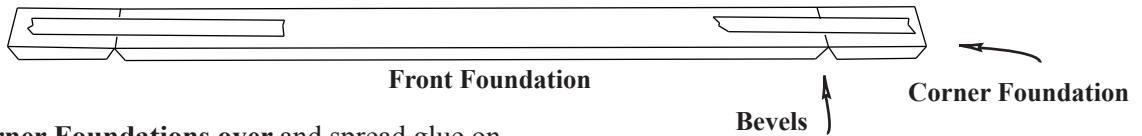

Turn the Front/Corner Foundations over and spread glue on all the beveled ends. Glue the Front and Corner Foundations together and to the Foundation/Base Floor. (Illustration #10)

Illus. #10

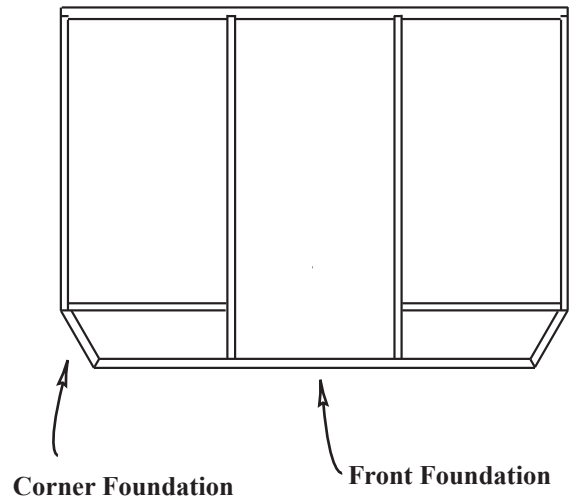

11. **Turn the Base Floor assembly over**; add lots of tape to hold the glue joint really tight. Check and adjust the foundation perimeter to match the floor perimeter. Weight the Base Floor assembly and make sure it is flat on a flat surface as the glue dries.



Let the glue dry, then take off the tape.

Mark and paint the Porch Floors/ceilings

12. **Set the Middle Floor on the Base**, lined up on the edges. Trace the edges of the Bay Floors onto the Base. Set a Pilaster  on edge against the Bay Floor edges of the Mid Floor, and trace along the outside of it. This gives a second line $\frac{3}{16}$ " (the thickness of the Pilaster) from the first. These line pairs will help position the Front set, and show the edges for painting the Porch Floor and the Inside Floor. Do not paint between these lines.

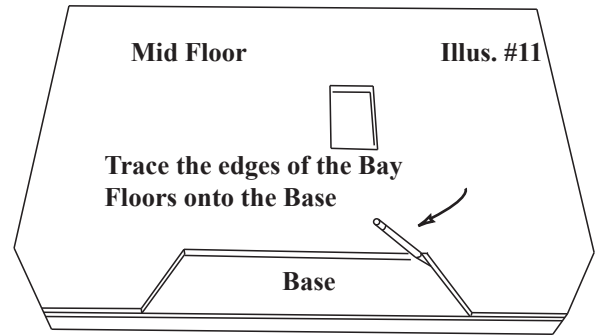
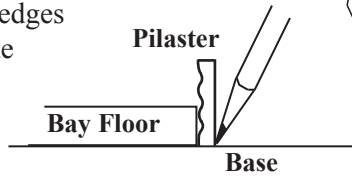

Set the Front Set on the Base spaced from the back edge with Dividers. Center the Front set side-to-side with the tracing (the inside surface of each Inset Wall is slightly inside the tracing). (Illustration #12)

Trace the inside and outside of the Front Set on the Base. Use these lines if you are painting the Porch Floor or Inside Floor - paint to just cover the line, but leave $\frac{3}{16}$ " or so unpainted.

If you are going to paint the Porch Floor, do so now.

If you are going to paint the Inside Floor, do the first coat and sand it now.

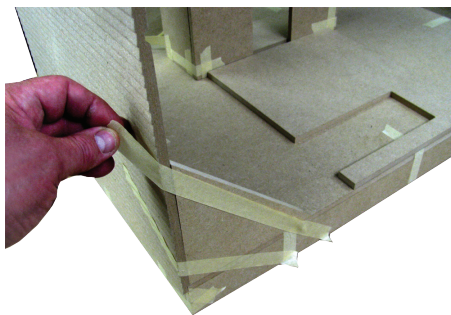
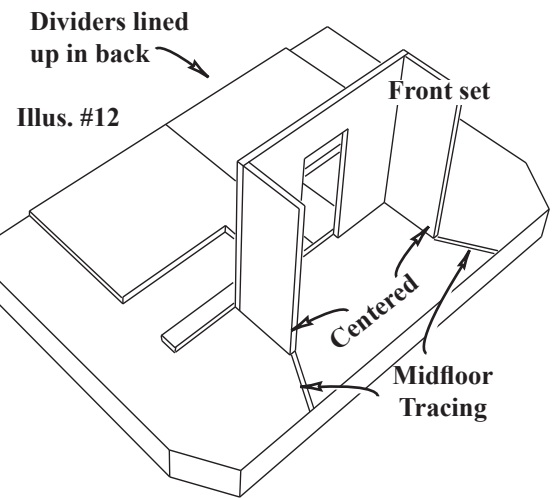

Without Glue, tape a Side Wall to the Base, lined up in back. Tape a Gable Triangle at the back edge to hold the Side straight. Repeat for the other Sidewall. Put a Front Spacer between the Sidewall and the Front Set on each side.

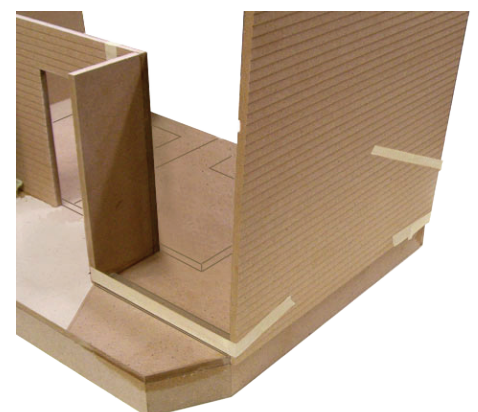
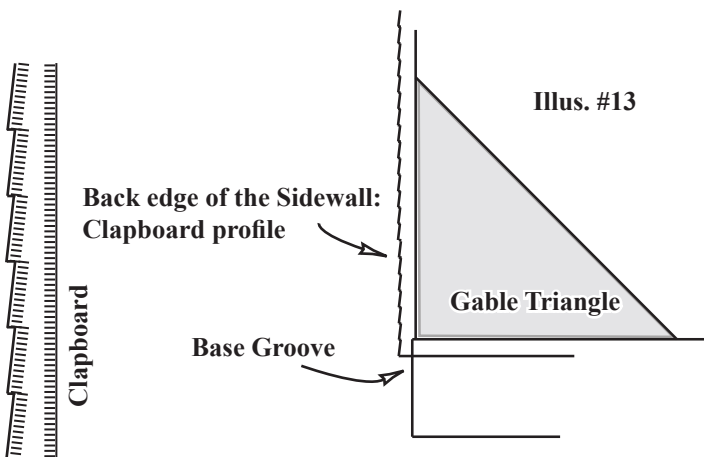
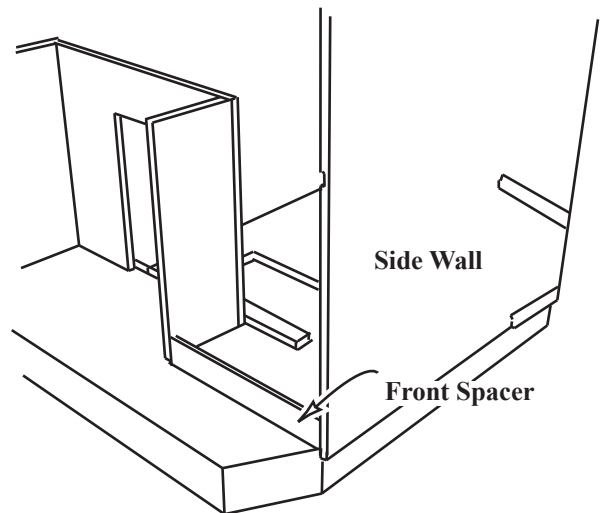

13. **Glue the Front Set** to the Base spaced from the back edge with the Dividers and centered side-to-side with the Front Spacers. Stretch tape a little above the floor all the way from one Side Wall to the other to tighten the Front Spacers. (Photo at right) Press down on the Front set, remove the Dividers, clean up the glue squeezings, then put the Dividers back. Weight the Front set, check the position against the Dividers and Spacers and let the glue dry. Use the other Front Set to trace-and-paint the bottom of the Mid Floor (Porch Ceiling) and the top of the Mid Floor (Balcony Floor). Trace-and-paint the bottom of the Top Floor for the Balcony Ceiling.

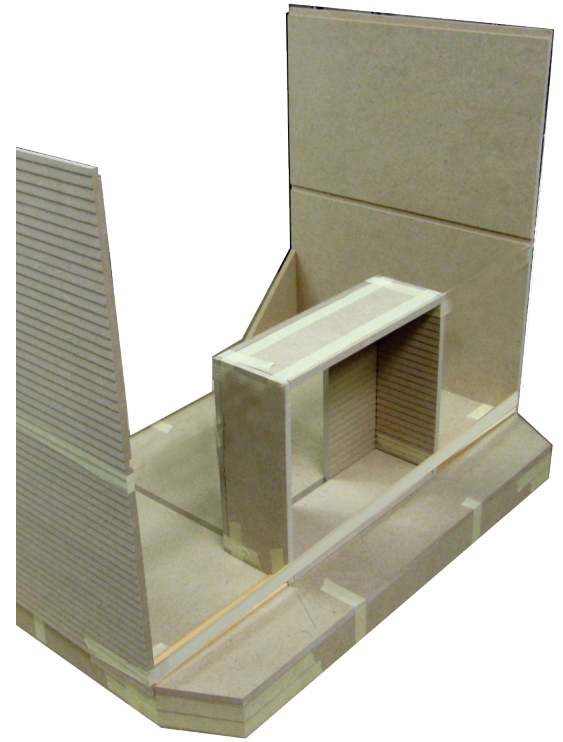

Let the glue dry

14. **Inspect the Front Set** to be sure nothing has moved while the glue was drying. **Remove the Side Walls.** Tape (don't glue!) Dividers to the back edge of Front Set, one on the left and one on the right. Tape the Dividers to the back edge of the house to hold them straight. (Illustration #14)

TEMPORARY use of the Dividers

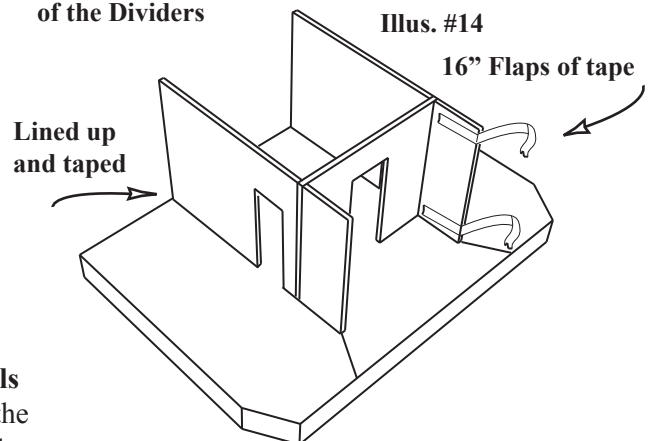

Complete steps 15 - 17 without letting the glue dry

15. **Spread glue in the base and mid grooves of the Side Walls** (the base is identified by the clapboard profile). Put a Side Wall on the Base (in the Side's base groove: Illus. #13). Tape the back edge of the Side to the Base using the Gable Triangle as a support square. Tape the lower front of the Side to the Inset with the prepared flap of tape. Tape the upper flap of tape from the Inset to the Side with a Front Spacer spacing and supporting the Side. (Illustration #15)

Illus. #15

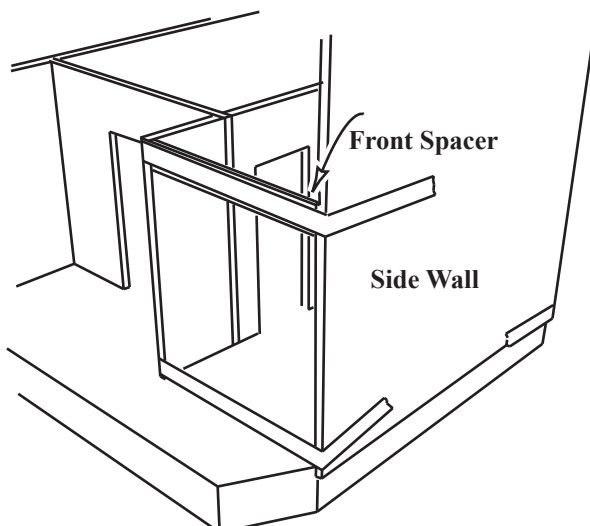

Don't glue the Dividers here!

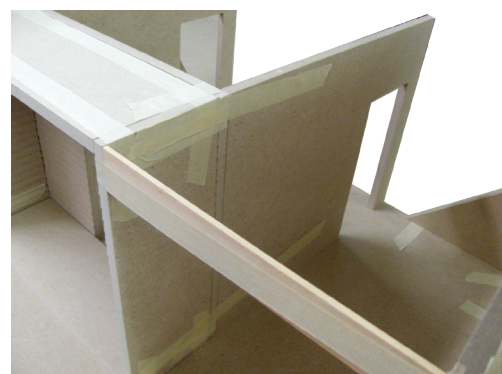

16. Repeat step 15 to attach the other Side Wall.
(Illustration #16)

17. Spread glue on the top edge of the Front Set.
Tip the Mid Floor into one Side's groove, then let the other
end down so it pops into the other. Stretch a band of tape
all the way around the house just above the Mid Floor.
Adjust the fit of the Floor at the back edges of the Sides.

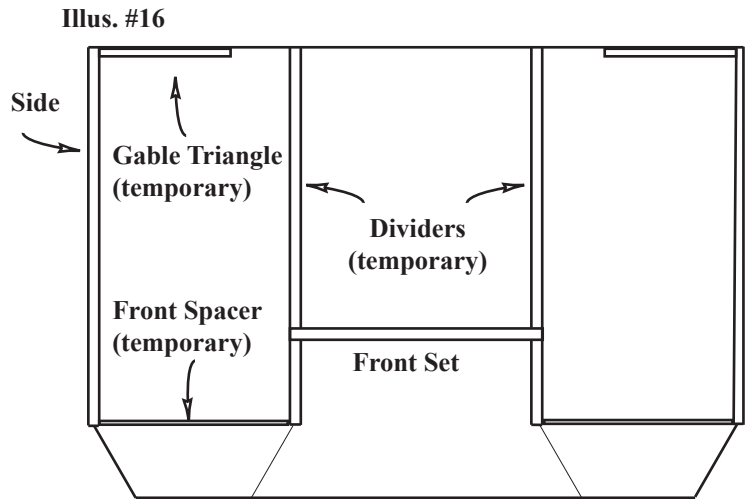

Don't glue the Dividers here!

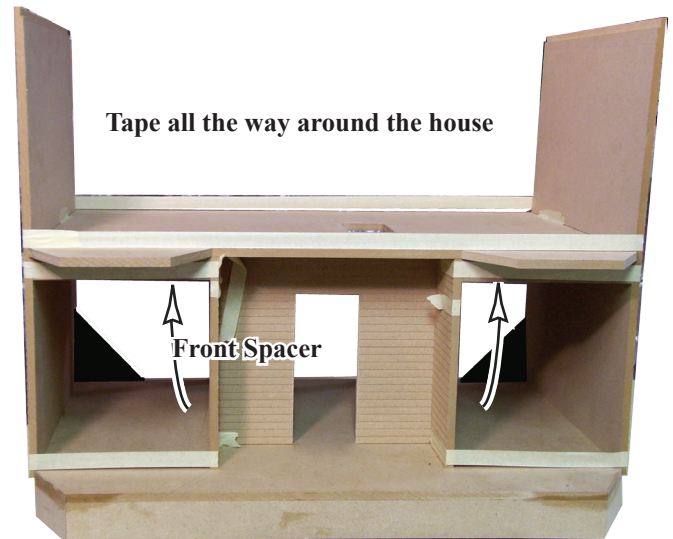

Put a front-to-back piece of tape at the joint between the
Floor and the Side to hold the Floor and Side exactly lined up
at the back edge. (Illustration #17A) Check the back edges
of the Dividers and press them front or back to make them
exactly line up with the back edge of the Floor. Put a front-
to-back piece of tape at the top of the Dividers to hold them
lined up in back.

Inspect the top of the Inset Walls. If they line up with the front edge of the
Mid Floor, then all the front-to-back tape on the Dividers and Sides has
worked. If not, now is the time to make the fit right. (Illustration #17B)
Let the glue dry

Illustration #17A

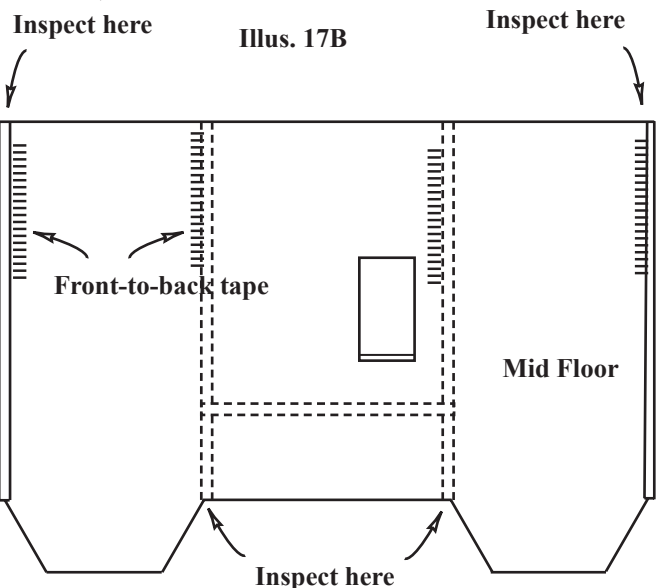
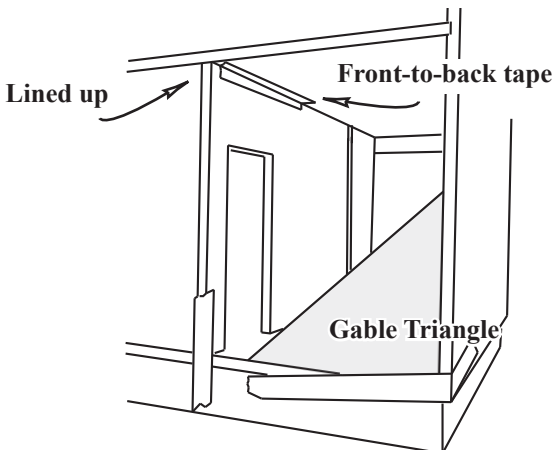

Dividers are temporary in this location

Let the glue dry

Inspect the floor at the back of the Dividers and Side Walls to be sure nothing has moved

18. **Glue the other Front Set to the Mid Floor**, lined up in front and centered side-to-side. Press down, clean up the glue squeezings, then add weight while the glue dries. Confirm the front-to-back fit with the Dividers and the side-to-side fit with the Front Spacers.

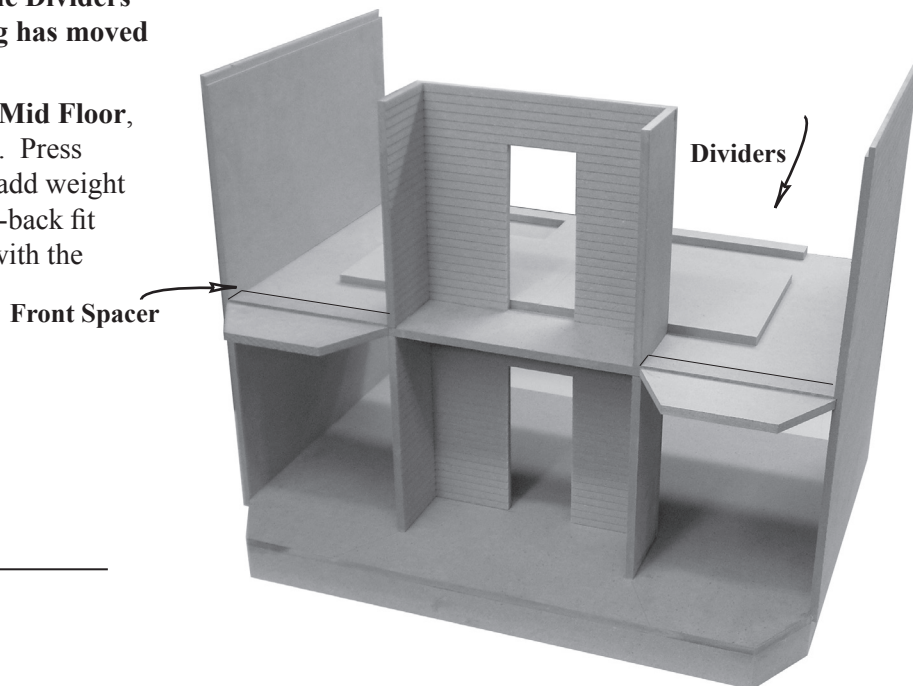

Let the glue dry

19. **Tape the Dividers** to the back of the Front set and to the back edge of the Mid Floor to hold the Front Set straight. Tape the Front Spacers between the top of the Inset Walls and the Side Walls, just-below the grooves for the Top Floor.

Apply glue to the top of the Front Set and to the ends of the Top Floor (NOT on the Dividers or Front Spacers). Put the Top Floor in place, lined up with the Sides in back, with the Dividers in back, and with the Front Set in front. Use the “front-to-back tape” technique to hold the inspection points (Illustration #17B) while the glue dries. **Tape the Top Floor tightly to the Sides** and put weight over the Front Set. Let the glue dry (Illustration #19B)

Illus. #19A

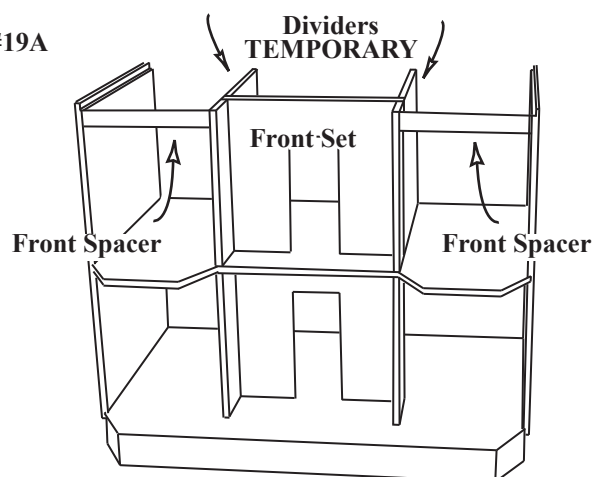

Illus. #19B
Top Floor

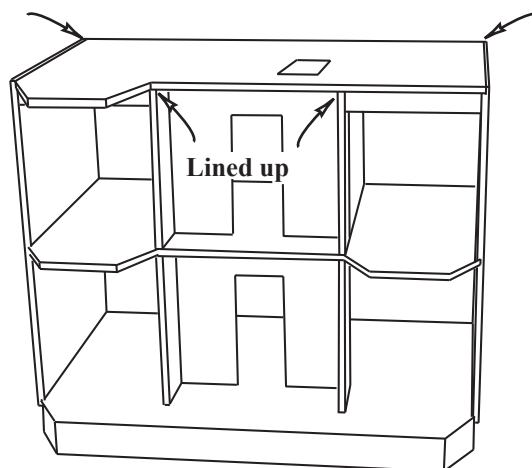

Inspect the floor at the back of the Dividers and Side Walls to be sure nothing has moved

20. **Glue and tape the Gable Floor** ($8\frac{1}{2} \times 3\frac{3}{8}$) to the Top Floor lined up on the right with the outside of the Right Side Wall. Extend a Divider under the Gable Floor for support as the glue dries.

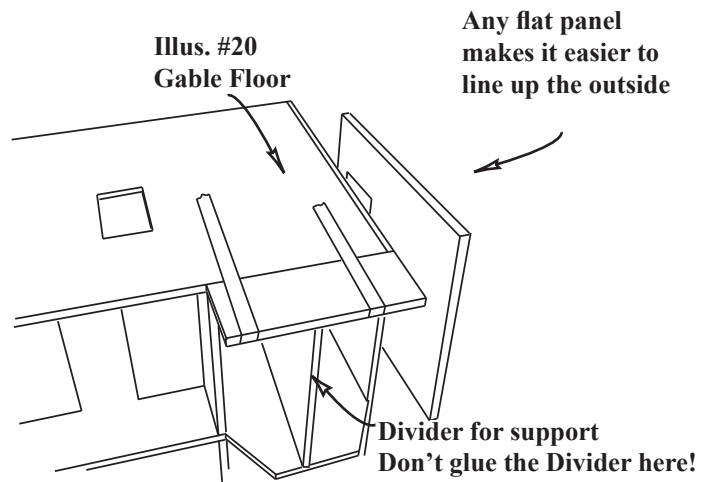

Let the glue dry

21. **Identify “up-and-down” for the Attic Front**
The Attic Front is an odd-shaped part, and builders often think the square edge (in the upper right in the photo) should go down... but if you start with the Gable Triangle in place (Illustration 23), it's easier to make the Attic Front fit

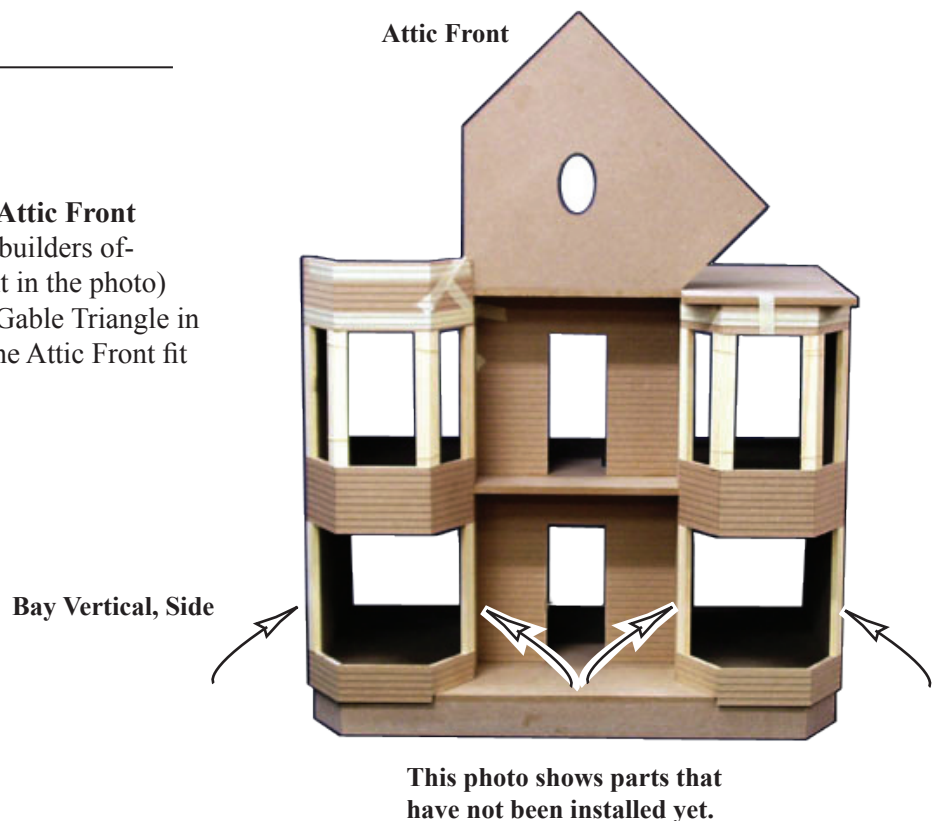

22. **Without glue**, tape together the Attic Front and the Gable Triangle (Illustration #23).

Glue the Attic Front to the Top Floor with the Gable Triangle lined up with the edges of the Gable Floor side-to-side and with the Attic Front lined up with the front edge of the Top Floor. Don't glue the Gable Triangle; it's only here to locate the Attic Front side-to-side, and it will be removed.

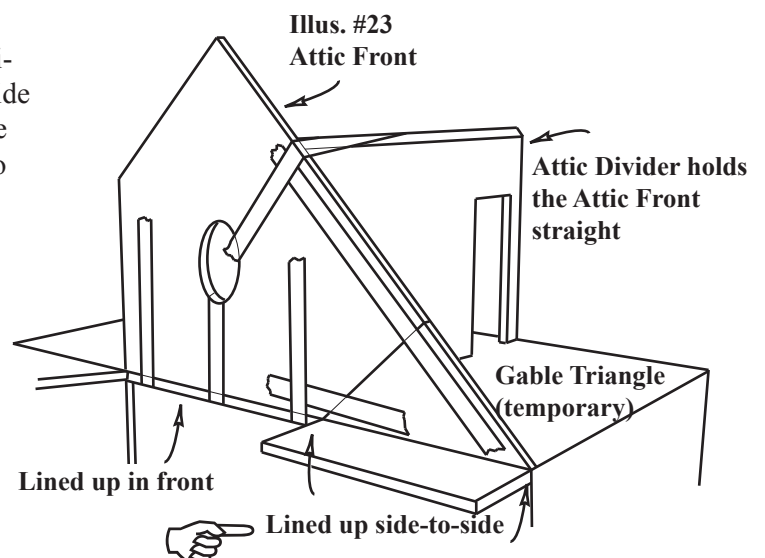

Let the glue dry

☐ 23. Lay out a set of Bay Walls for the Base; one 4³/₄ Front with a groove at the bottom, one 3³/₄ Side with a groove at the bottom, and one 3³/₄ Side with no groove (it's the same as the "Top Bay Walls").

Line them up at the top (check the clapboard on the one with no groove) and tape across the face leaving a 4" flap on both ends.

Turn the Bay Walls over, spread glue on all the beveled ends, in the grooves, and on the bottom edge of the un-grooved wall.

Install and tightly tape the Bay Wall set to the house. (Illustration #21B)

Repeat for the Bay Wall set on the other side of the Base.

Illus. #21A

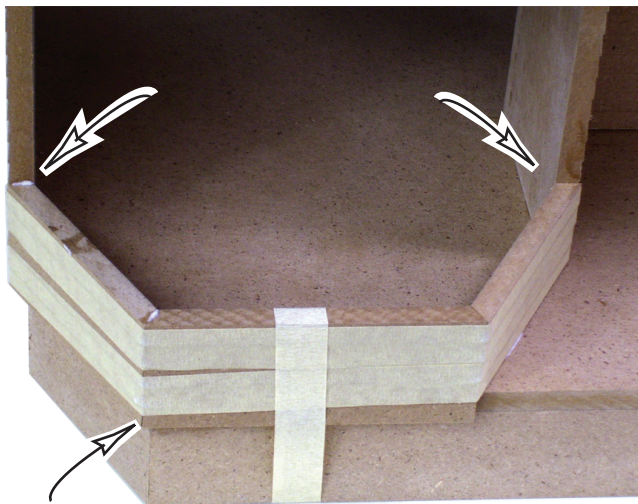
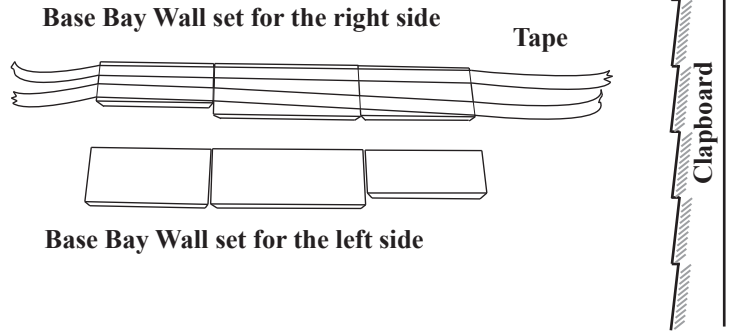

Illus. #21B

Right Bay Wall set

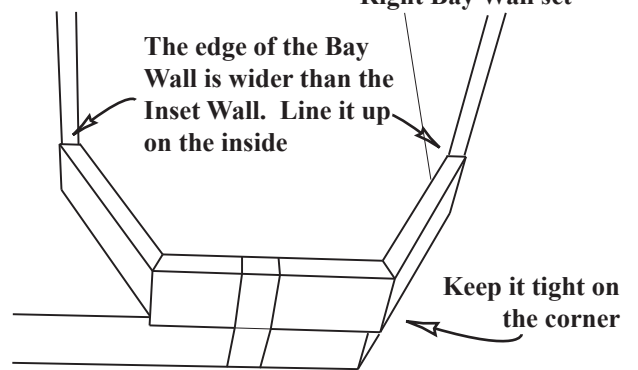

Illus. #21C

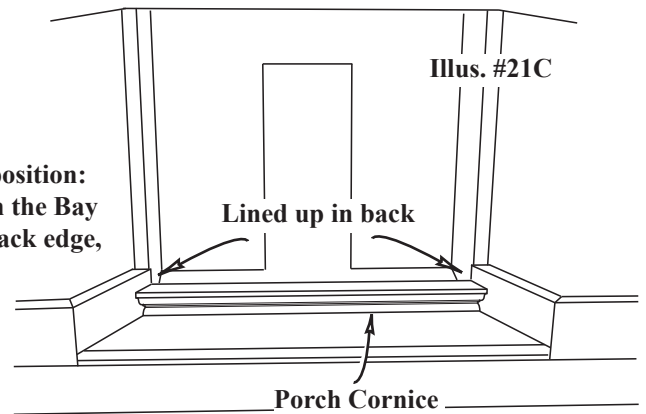

A final check of the Bay Walls' position: Hold the Porch Cornice between the Bay Walls. When it lines up at the back edge, the walls are perfect

☐ 24. Glue a Bay Vertical, Side to the front edge of each Side Wall and the top of the Base Bay Wall, lined up on the inside. Repeat for the Inset Walls... 4 Bay Vertical Sides.

Illustration #24

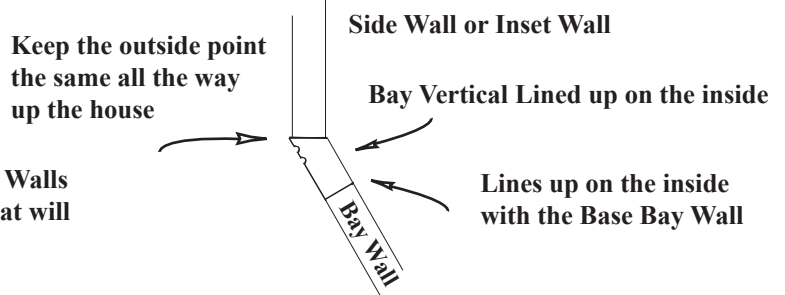

Note: the point of the Bay Verticals and Bay Walls that sticks out will rest against Stripwood that will be installed in Step 60

25. Lay out a set of **Mid Bay Walls** with all the clapboard facing down on each Wall (Illustration #25). Tape the Walls together and leave a 4" flap of tape on each end.

26. Turn the **Bay Wall Set over**. Spread glue in the grooves and on all the ends. Tape the Bay Wall set to the house. Line up and tape the Bay Wall set to the Bay Verticals on the inside.

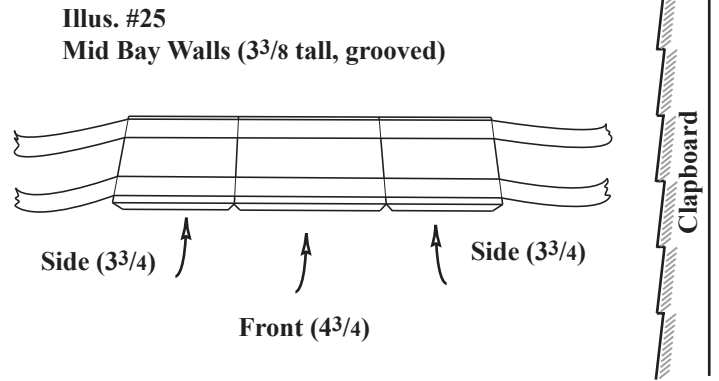

Note: The Clapboard profile is not continuous around the corner to the Side... it is separated by the Trim (Step 60)

Inspect the Bay Verticals and the ends of the Bay Walls (Illustration #24).

When they are straight up-and-down, the outside point of the Bay Wall will be the same for the Base set, for the Mid set, and all along the tip of the Bay Vertical. When this is the way the Bay Walls fit all the way up the house on both sides of the Bays, then they will be straight on the house (a good thing!)

Without glue, put the Bay Vertical Corners in place to hold the vertical spacing. (review Illus. #21C)

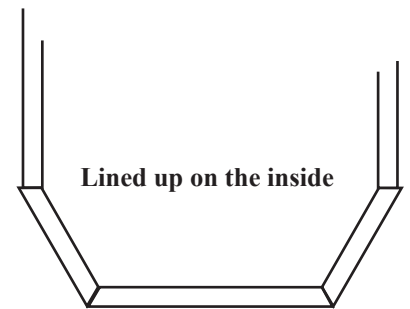

Illus. #26
Bay Walls
Bay Vertical, Sides

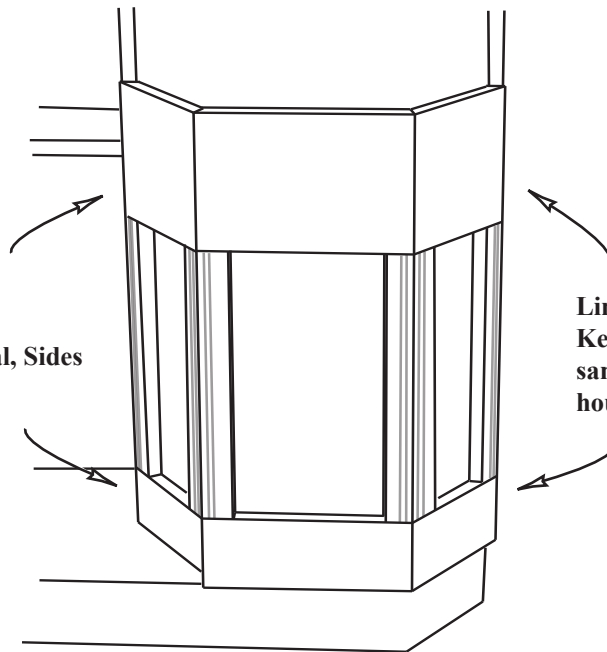

Line them up on the inside -
Keep the outside point the
same all the way up the
house

Temporary use of the Bay Vertical, Corners - Don't glue them here

27. Attach **4 more Bay Vertical Sides** to the Inset and Side Walls abover the Mid Bay Walls (Illustration #24)

28. **Build another set of Mid Bay Walls** as you did in steps 25 and 26. Glue and tape the Mid Bay Wall set to the Top Floor on the left. Keep the points of the Walls the same, as in Illustration #26. Tape to the inside of the Attic Front (Illustration #28)

Illustration #28
left bay

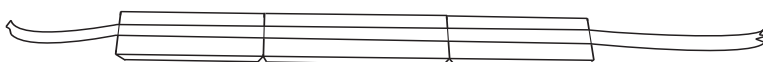
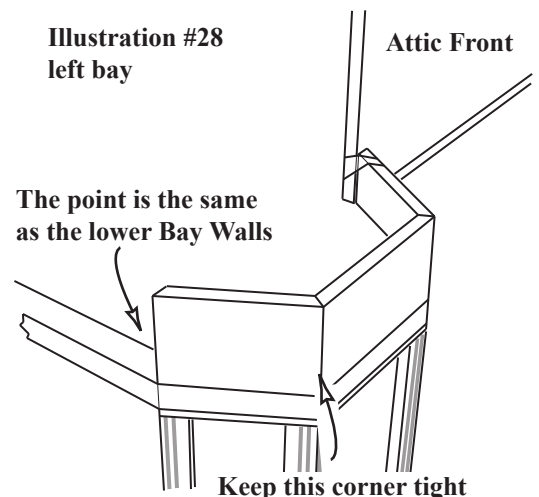

29. **Tape together a set of Top Bay Walls** (1 1/2" tall, no groove) Glue and tape the Top Bay Walls to the walls and to the underside of the Gable Floor.

Adjust the points to match the lower walls so the Top Bay Walls will be straight above them (review Illus. #21C) and the corners of the Top Bay Front line up with the corners of the Mid Bay Front. Use one of the largest Window Panes as a square against a 'Bay Vertical, Corner' to line up the corners of the Bay Walls.

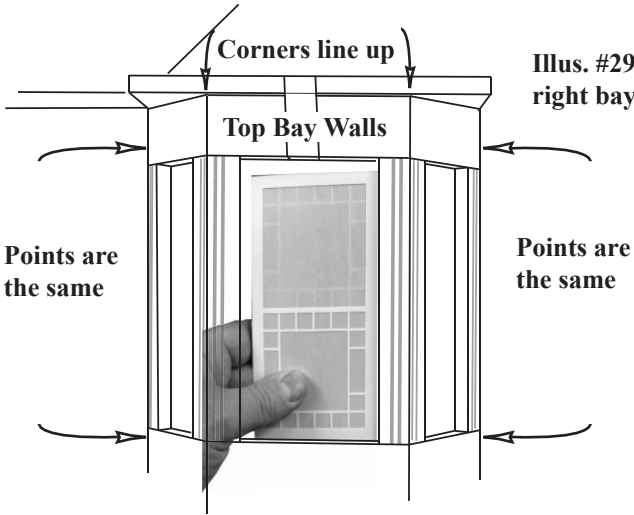

Temporary use of the Bay Vertical, Corners - Don't glue them here



Let the glue dry

30. **Draw Shingle Guidelines** on the Left Roof, Right Roof, and the Gable Roofs. Draw the first Guideline 1/4" from the bottom edge (the top edge is beveled) if you are going to use a "starter row" of shingles, or 1/2" if you are going to flash the bottom edge with Real Good Toy's Copper Flashing ("SC" from www.realgoodtoys.com). Draw the rest of the Guidelines 1" apart. (see step 66)
Draw all the Guidelines on the Tower Roofs 1" apart

This drawing may print differently from the layout - confirm the measurements before drawing your shingle guidelines

Bevels are on the inside of the Roofs (face down)

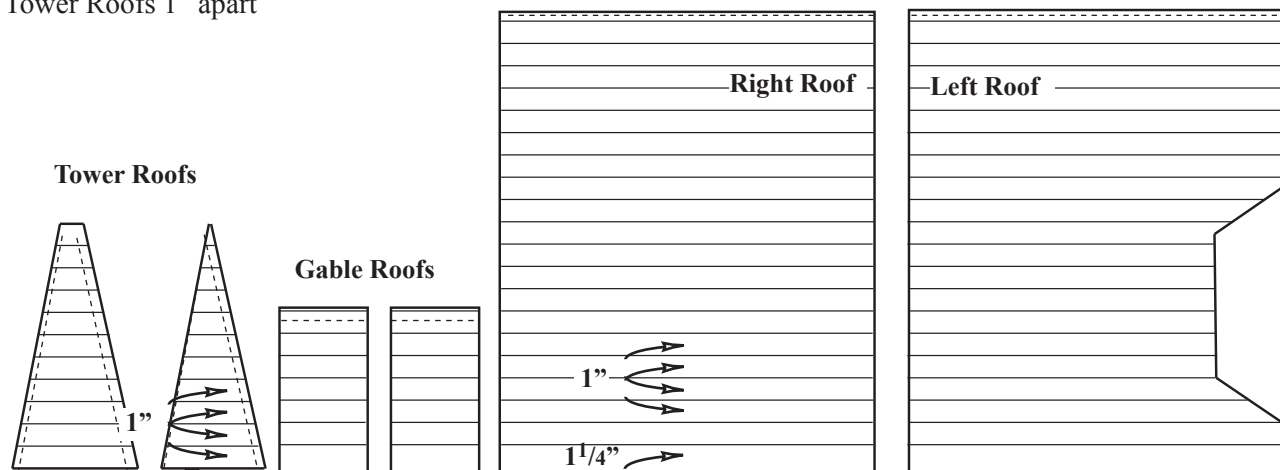

Guideline Measure

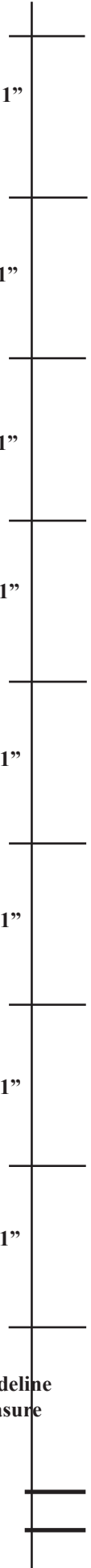

31. **Make a temporary Roof Support:** Hold a 1” Stripwood behind the Attic Front, straight up-and-down, and centered behind the peak. Use the edges of the Attic Front as a saw guide to cut the Stripwood to exactly match the Attic Front at the peak. (Illustration #31A)

Illustration #31A
The Attic Front from inside the Attic

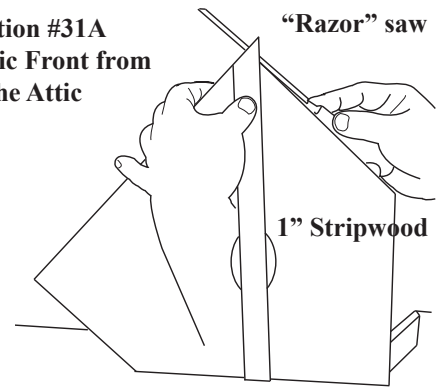

Make a temporary Roof Support Stand by taping two Gable Triangles together and taping the Roof Support to them. Put the Stand in the center at the back edge of the Top Floor

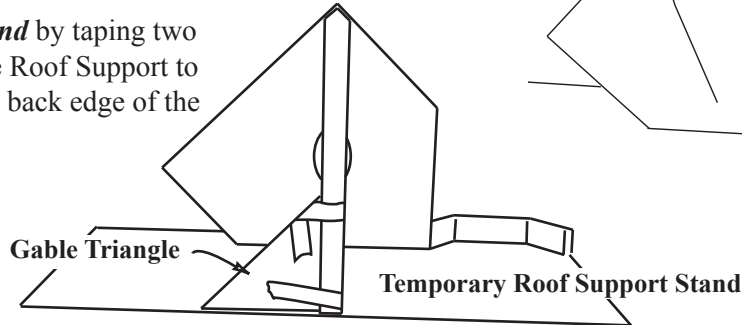

32. **Tape together the Left Roof and the Right Roof** at the peak (the ends with the bevels) Fold the Roofs at the peak and put them on the house, lined up with the face of the Attic Front. The Roofs are supported at the back edge by the Roof Support Stand. Mark and paint the underside of the Roofs where they overhang the Sides.

Illustration #32

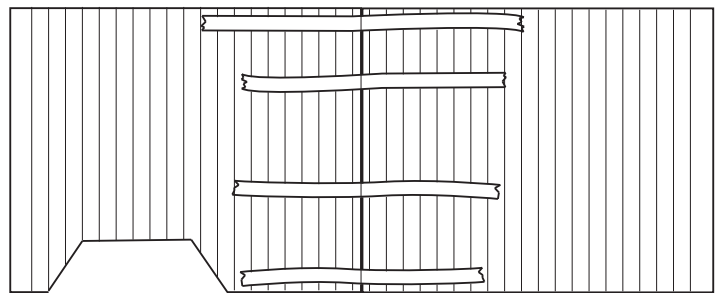

33. **Turn the Roofs over** and spread glue on the bevels. Spread glue on the top edges of the Attic Front. Tape the Roofs to the Attic Front and add additional tape as necessary to keep the Left Roof tight to the back of the Bay Walls (Illustration #33A) and lined up with the back edge of the Gable Floor (Illustration #33B).

Illustration #33A

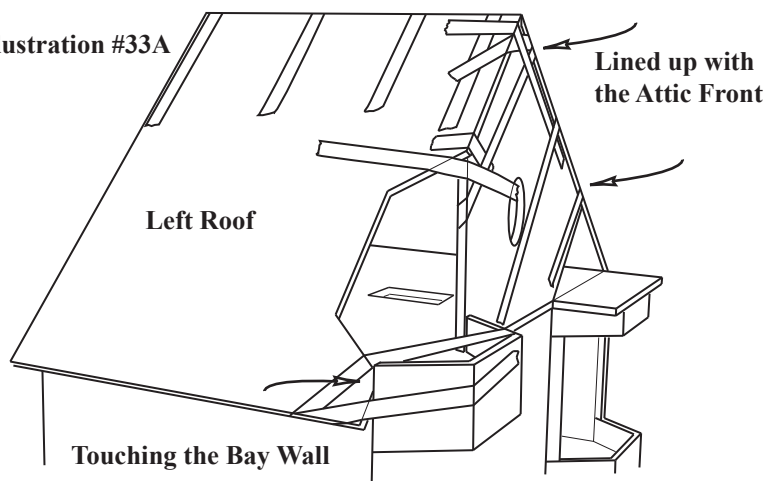

Lined up with the Attic Front
Illus. #33B

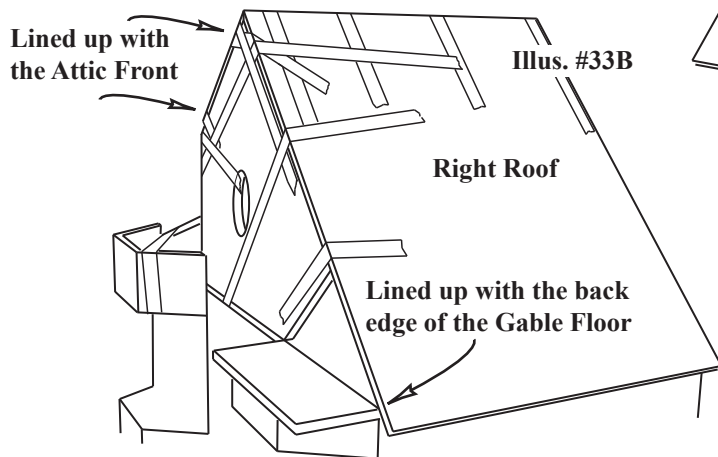

The back edge of the Roof overhangs the back edge of the house

34. **The Kneewalls** have a shiny edge; that's the one to leave exposed in the Attic. Glue the Kneewalls into the left and right corners of the Attic, lined up at the back edges.

On the Right Kneewall (viewed from the front), don't put any glue on the part that extends over the Gable Floor - it will be adjusted later to line up with the Gable Triangle after it is installed.

Tape the Front Spacers to the Top Floor to push the middle of the Kneewalls tight into the corner.

Tape the Roofs as necessary to keep them touching the top edge of the Sides.

Check again to be sure the Right Roof still lines up with the back edge of the Gable Floor.

Illustration #34

View from the back

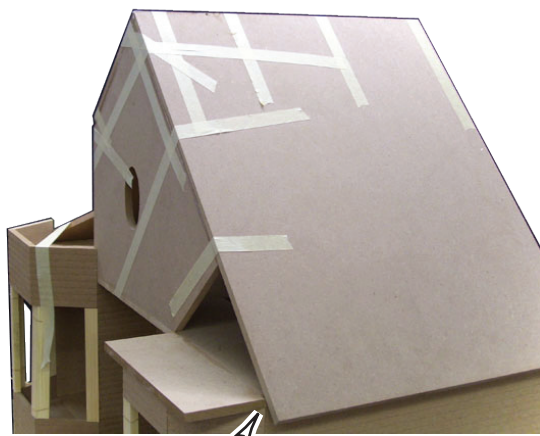
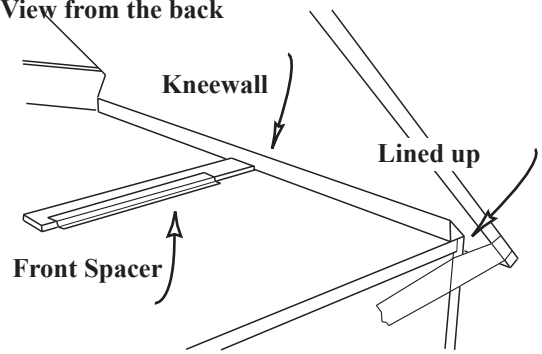

Check

Let the glue dry

35. Hold a Divider on the Gable Floor and hold a yard stick against the edge lined up with the peak of the roof. The edge of the Divider is now in the center of the Attic Front. Draw a reference line on the Attic Front in pencil for future trim layout.

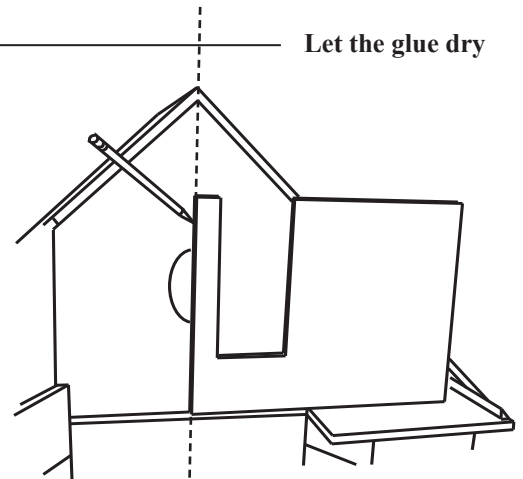

Draw a reference line

36. **Test, adjust if necessary, then glue and tape** the Porch Edge to the front edge of the Base Floor. (Illustration #42) Hold the Step Back below the Porch Edge to confirm the fit. Decide if you prefer the look of the Front Steps with or without the Step Back before painting the foundation.

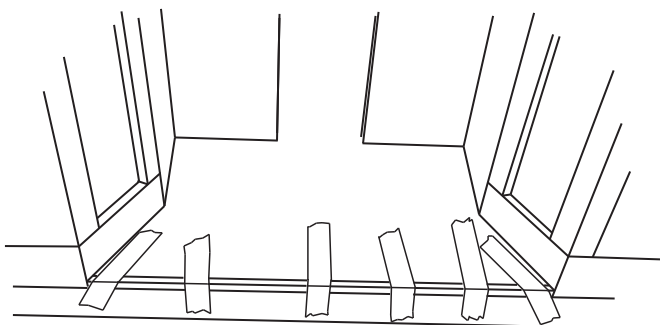

The Porch Edge

Illustration #42

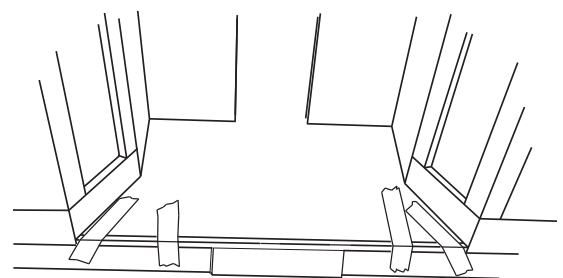

Step Back (optional)

37. Lay out and tape together the Tower Back Walls.

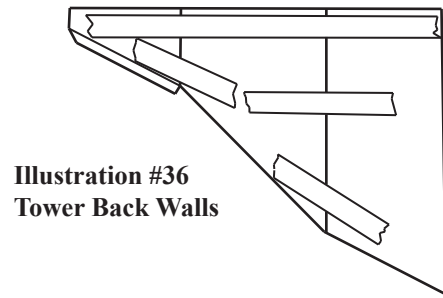
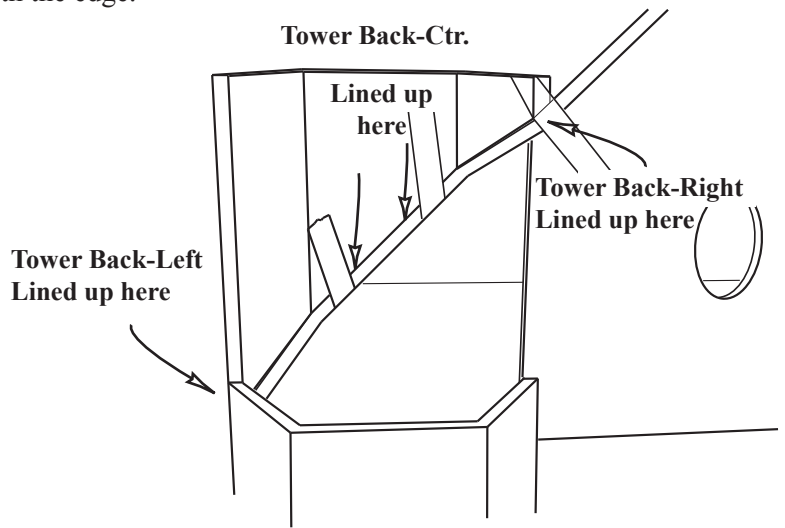

Illustration #36
Tower Back Walls

38. Glue and tape the Tower Back Walls to the Roof, lined up with the cutout. Tape the Tower Back-Right to the front edge of the Roof lined up with the corner of the cutout (Illus. #37A) (this tape will be removed shortly). Tape the Tower Back-Left to the Bay Walls (Illus. #37B). Adjust and tape the Tower Back-Ctr. to the Roof, lined up or parallel with the edge.

Continue to step #38 without letting the glue dry

Illus. #37A



Illus. #37B

Tower Back-Left
Lined up here

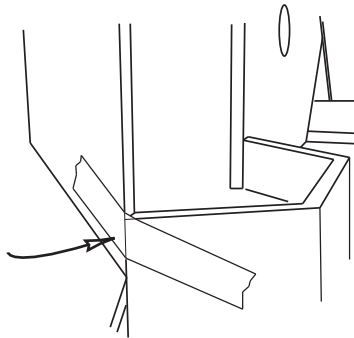

39. Tape together a set of Top Bay Walls. (Illus. #38A)

Illustration #38A: Top Bay Walls

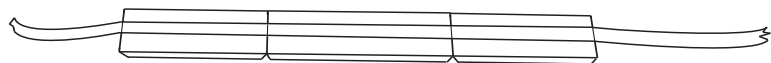

Glue Bay Verticals to the edge of the Tower Back-Left and the face of the Attic Front.

Glue and tape the Top Bay Walls together, to the Bay Verticals, and to the Tower Back, Roof, and Attic Front (the in-the-way piece of tape (step 37) has to be removed).

Illus. #38B

Top Bay Walls

Bay Verticals

Yard Stick

Hold a Yard Stick against the Bay Walls and make the top straight with the lower Bay. (Illus. #38B) The most important fits are:

- The Bay is straight
- The Top Bay Walls touch the Bay Verticals.

Put Bay Vertical Corners between the Bay Walls to hold the spacing while the glue dries.

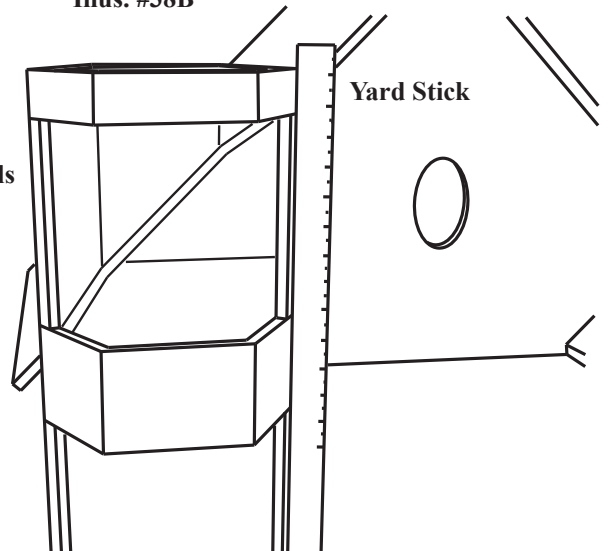

40. **Glue and tape the Gable Triangle** to the top of the Gable Floor, lined up in front and side-to-side. Tape a Porch Spacer against the back edge of the Gable Triangle to hold it straight as the glue dries

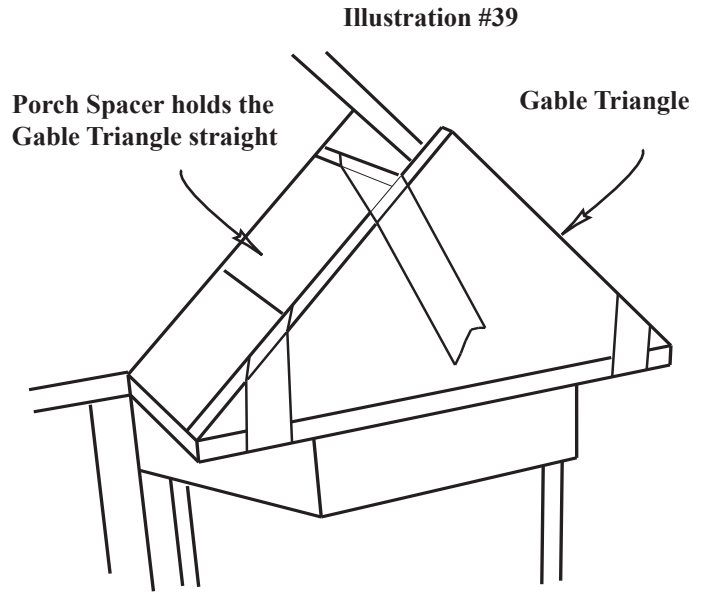
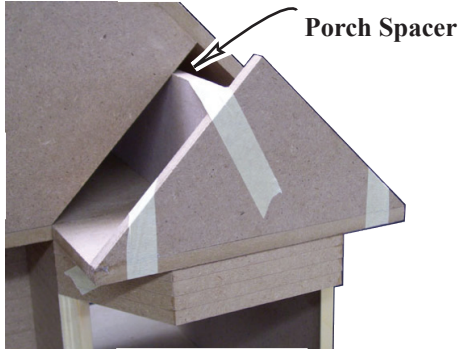

41. **Adjust the end of the Kneewall** that extends over the Gable Floor to line up with the edge of the Gable Triangle. Glue and tape the Kneewall in place. (Illustration #40)

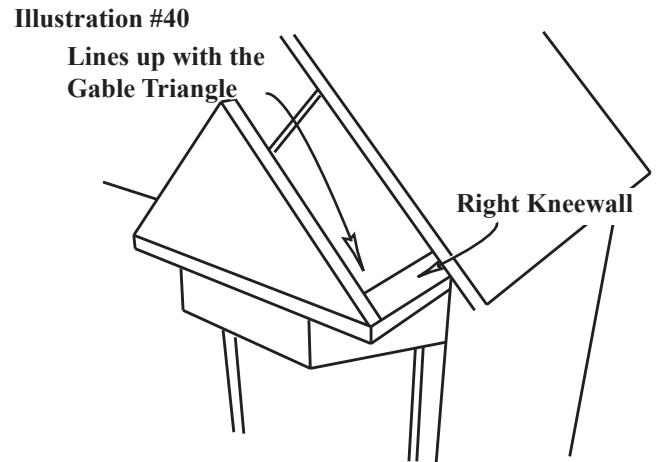
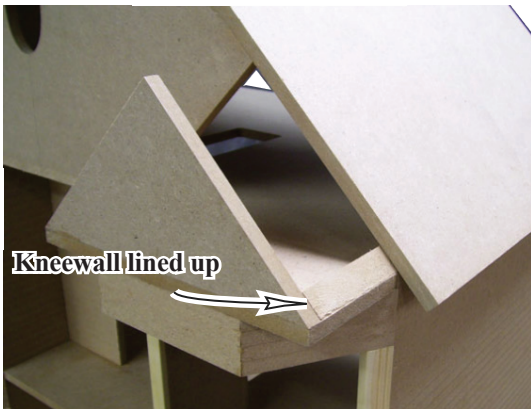

Let the glue dry

42. **Tape together the Gable Roofs** at the peak (Illus. #41A). Test, then glue and tape the Gable Roofs to the house everywhere they touch (Illustration #41B).

Illustration #41A

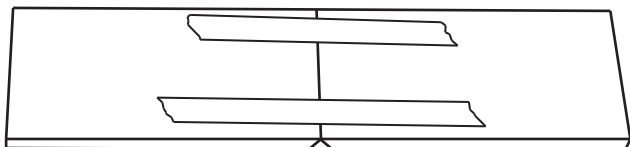
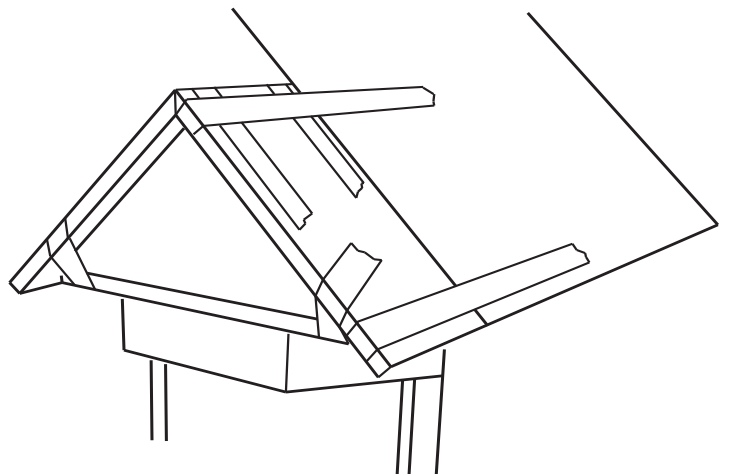

Illustration #41B



Lining things up: You are putting together many parts and lining them up with each other and with parts that are already in place... it's easy to get lost!! Start by having the parts touching and with everything lined up on the inside with the walls. After the tape is tight, pinch the parts to line up on the inside again, then make the outside work too (like 44B).

☐ 43. **Glue $1/8 \times 25/16$ " Window Blocks** to the Bay Sides of the first floor Bays, touching the Bay Verticals on the ends. As you are putting glue on the Window Block, put a dab on each end too so the Block will be glued to the Bay Vertical Sides and to the Bay Vertical Corners. Glue $1/8 \times 35/16$ " Window Blocks to the Bay Fronts, centered side-to-side.

☐ 44. **Glue Bay Vertical Corners** to the Bay Walls and Window Blocks. Stretch tape around the bay to the walls behind so the Corners will be tight in the Bays (Illustration #44A). Adjust the Corners to line up with the corners of the Bay Walls. Pinch the Window Blocks straight and lined up with the Bay Verticals on the inside, then re-adjust the Corners' side-to-side fit (Illustration #44B).

Illus. #43

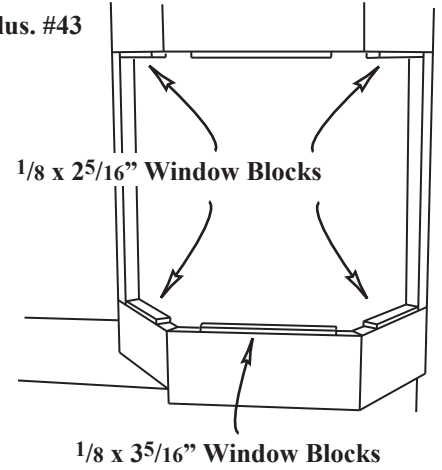

Illus. #44A

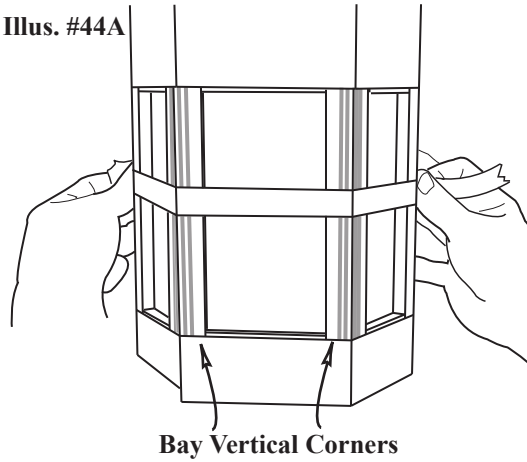

Illus. #44B

Lined up in the corner

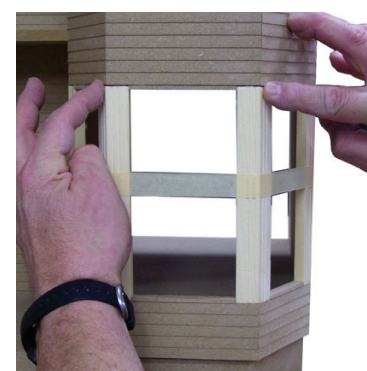
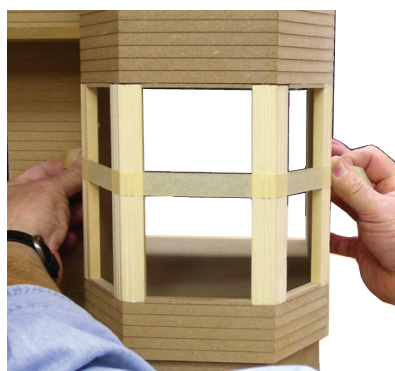
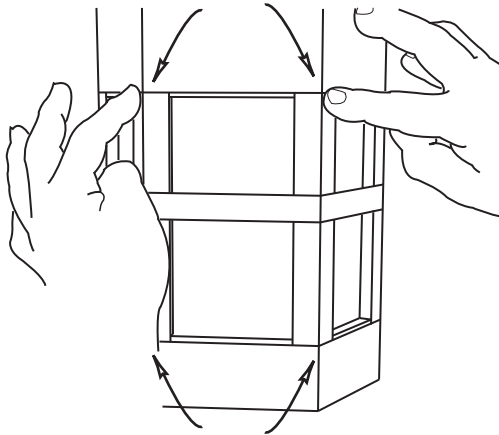

☐ 45. Follow steps #43 and #44 for the Mid Bay openings using the 1 1/8 tall Window Blocks for the bottom and the 1/8" tall Window Blocks (the same as the 1st floor's Window Blocks) for the top.

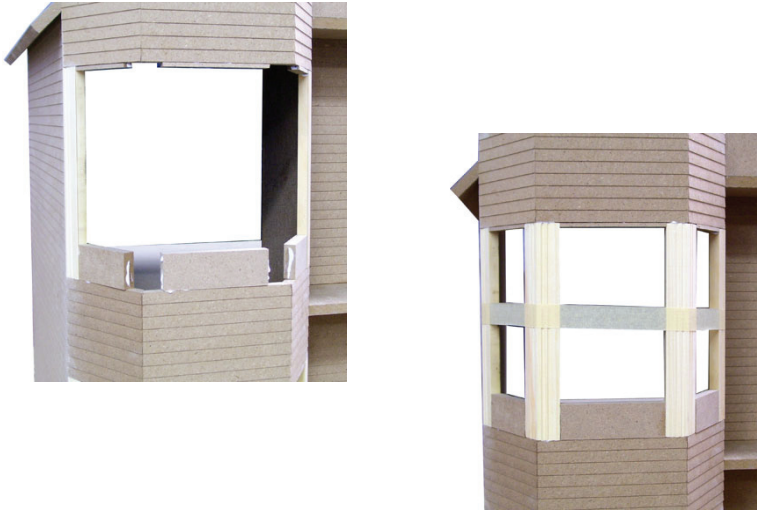
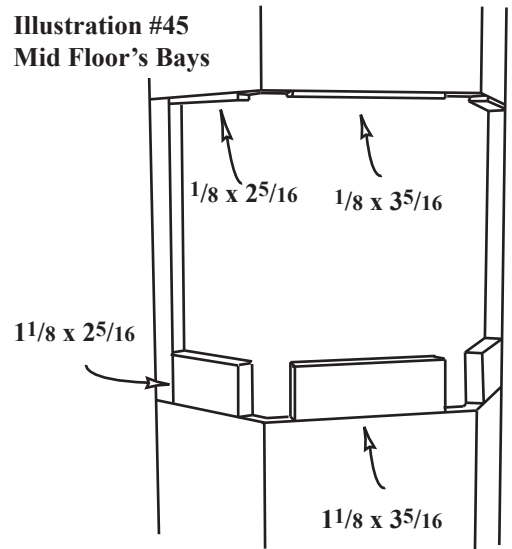

Illustration #45
Mid Floor's Bays



☐ 46. Follow steps #43 and #44 for the Tower Bay openings using the 2 1/8 tall Window Blocks for the bottom and the 1/8" tall Window Blocks for the top.



Illustration #46
Tower's Bay

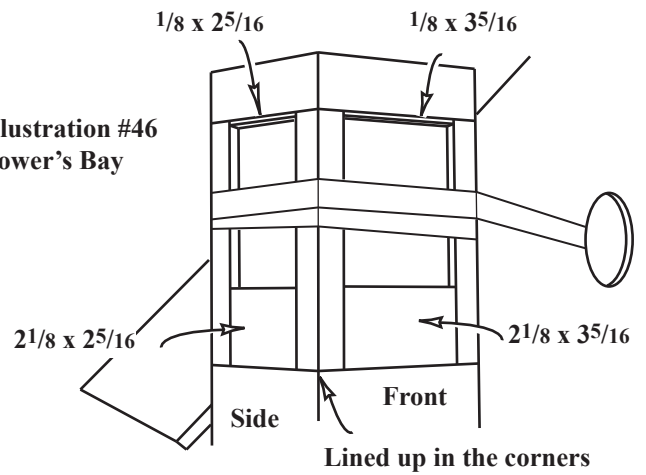

Let the glue dry

Window Assembly:

dhbuilder.com has more window assembly photos

47. **Paint (first-coat) the Window Frames.** Do not get paint on the ends - *wipe off any paint* that has crept around the corner onto the ends. Sand the Window Frames. The Frames will be re-painted after assembly.

48. **Each window is identified by the size of the Pane,** so test each size of Window Pane with the different Frame sizes to see how they are used.

Window Panes:

- 2) 1st Floor Front 6³/₈ x 3¹/₈
- 4) 1st Floor Side 6³/₈ x 2¹/₈
- 2) 2nd Floor Front 5³/₈ x 3¹/₈
- 4) 2nd Floor Side 5³/₈ x 2¹/₈
- 1) Tower Front 4³/₈ x 3¹/₈
- 2) Tower Side 4³/₈ x 2¹/₈

Each window has two frames, one for the inside and one for the outside. Set up frame parts for two sets of windows for each pane

Test assemble (no glue) a window Frame set. Practice holding the frame pieces face-down on the work surface and putting on the rubber band. When you can do it every time without pieces flying, then you are ready for glue.

Steps in banding a window set:

- Lay out two side frames with the frames face down on the table or on a piece of cardboard (less slippery).
- Set the top and bottom frames in place.
- Put a rubber band on your thumb and index finger, and push down on the Side Frames with those fingers.
- Stretch the band over the top.
- Switch hands with the new thumb and index finger also pushing down on the Side Frames. Now stretch the rubber band over the other end of the window.
- Press down on each corner to line up the frames and make the surface of the window flat.

Too frustrating? A snip of tape in each corner will keep the pieces from flying, but remove the tape after the rubber band is on so the parts can self-locate from the pressure of the band in the corners.

Glue and rubber band together all the Window Frames. A word about mullions: Painted mullions can be nicked in handling before assembly or at any time in the life of the dollhouse. In use, it is seldom easy to see that a mullion has been nicked, but if you do want to touch-up the mullions, mask the edges of the damaged mullion with "magic" tape, rub the tape down on the edge next to the mullion, and paint between the tape with "white-out"). Let the paint dry thoroughly before removing the tape.

49. **Paint (second-coat) the Window Frames**

Illustration #48A
Cross section of window

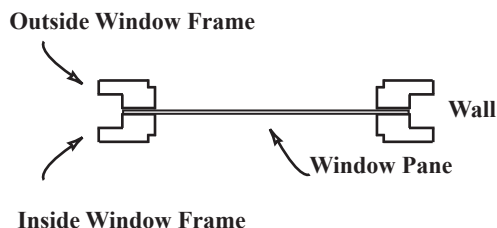

Inside Window Frame

These hands are holding the frame parts down against the table (not squeezing them together)



Outside Window Frame

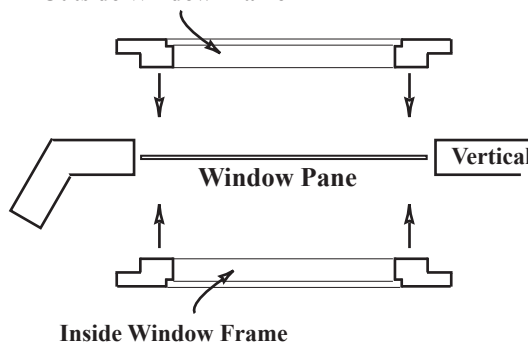

The Window Pane will sit in the window hole and be held in place by the frames. It is not glued.

50. **Tape together the Tower Roof set** (two Corners, the Face, two more Corners, then the Spacer), carefully lined up at the bottom edge. Wait to include the Tower Roof Back, use the Spacer to make the right space for the Back. (Note: the Spacer may be glued in if you do not want access the the room within the Tower Roof).

Illustration #50
Tower Roof set

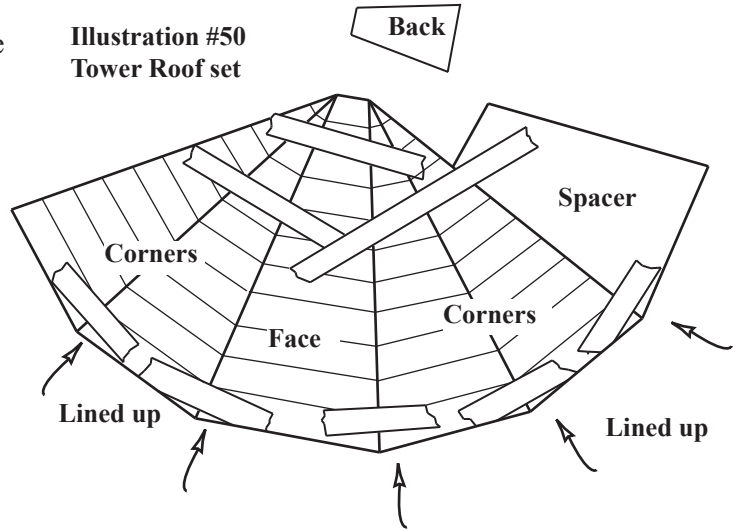

51. **Turn the Tower Roof set over.** Spread glue on all the bevels except the ones that will touch the Tower Roof Spacer. Fold up the set and carefully line up the last corner. Tape the Roof set firmly together.

Illustration #51

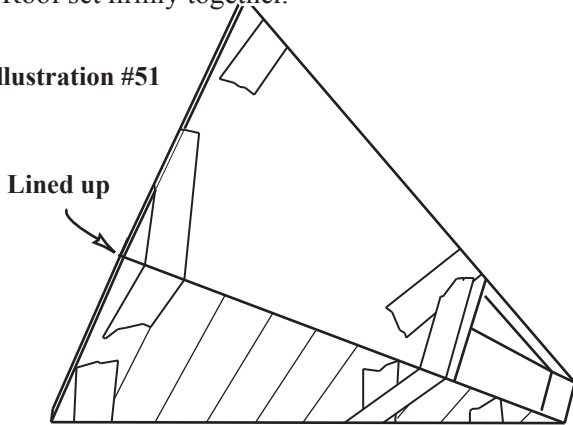
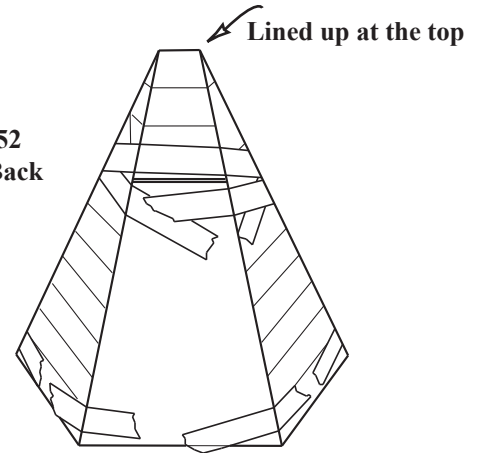

Illustration #52
Tower Roof Back



52. **Glue and tape the Tower Roof Back** to the roofset, lined up at the top.

53. **Glue the Tower Roof set into the Tower Ceiling's** groove. The flattened corner of the Tower Ceiling is the right end. Tape the Tower Roof set to the Ceiling if necessary for a good fit. When the glue is dry, decide whether you will keep the Spacer as part of the rear Tower Roof. If not, cut-to-fit and glue the 1/4 x 1/8 x 7/16 Groove Fill to fill the un-used part of the groove in the Tower Ceiling.

Illustration #53

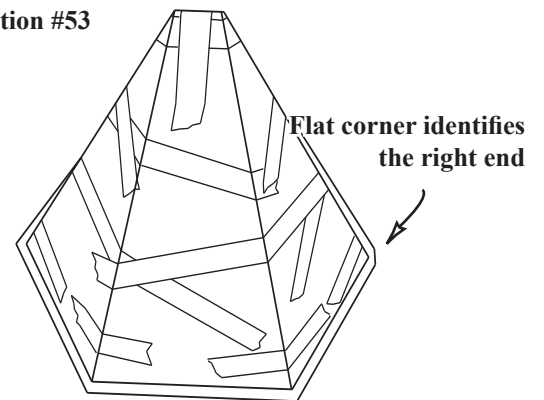

54. **Test, then glue and tape the Eaves** to the front edges of the house roofs. Note: there is clearance between the Gable Roof and the Right Eave for shingles.

Illustration #54
Eaves

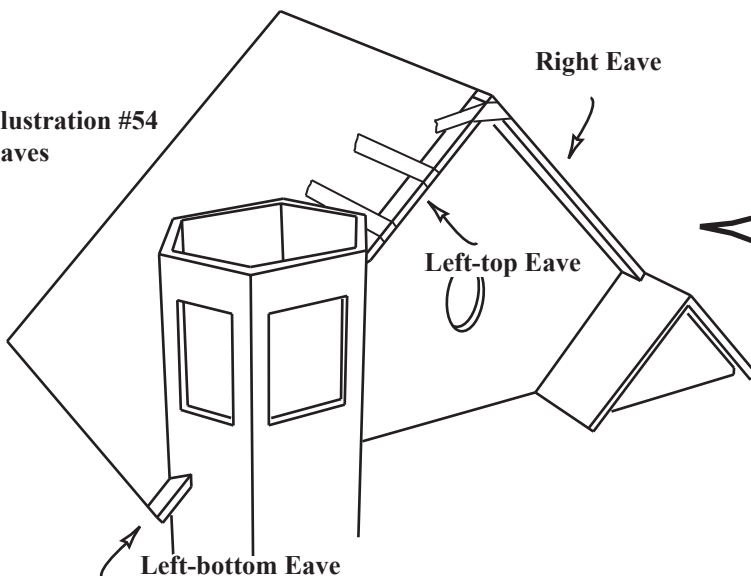

**Builders...
Don't skip the "Eaves"!**

If the Eaves aren't attached, the Nosing and Trim won't fit.

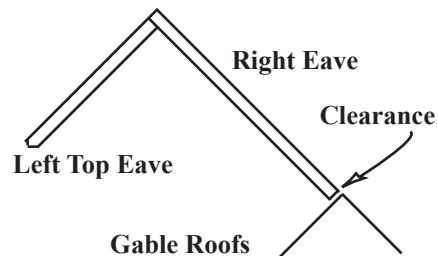

55. Balcony Rail Assembly

A. 1. Paint (the first coat) and sand the Rails before assembly.
Wipe any paint out of the grooves, and do not paint the Rail ends at all.
Paint and sand the Dowels.

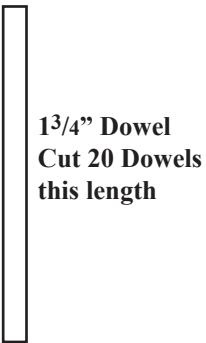

1^{3/4}" Dowel
Cut 20 Dowels
this length

2. Cut 20 Dowels 1^{3/4}". Lay a dowel on the diagram, lined up on the end. Press down with a utility knife on the other end of the dowel-length and roll the Dowel so the knife makes a cut all the way around. Snap off the Dowel at that cut. (see the photo on the next page)

B. Assemble the Railing:

1. Set one Balcony Rail on the drawing, lined up on each end. Put a dab of glue and a Dowel in the Rail's groove for each Dowel in the drawing. Adjust the Dowels to match the drawing; be sure all the Dowels are even, straight, and square. Let the glue dry for a few minutes.

2. Lift the Dowels with a piece of stripwood; dab a little glue onto each Dowel's end. Hold the second Balcony Rail over the Dowel's ends at an angle.

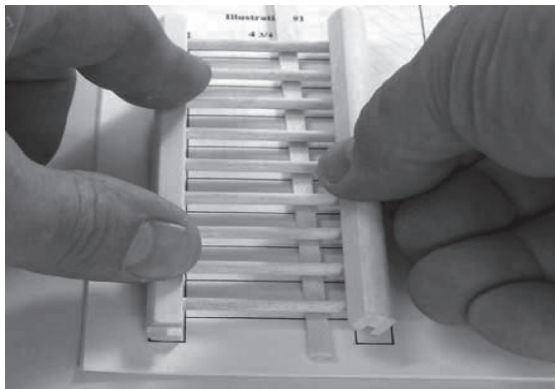

Note: This diagram does not print to scale on many printers. Compare the length of the printed diagram to your Rail. If it is not very close, talk to your web manager or adjust the 'scaling' for printing a PDF file in your printer settings

Push down and scoop the Dowels' ends into the groove.

3. Squeeze the Rails together so the Dowels are fully in the grooves.
4. Hold the Railing set on the drawing; make the Rail ends exactly line up. Adjust the Dowels - - straight and square. Tape together Dividers to form a square inside corner, and lay the Railing in the corner as the glue dries

C. Paint (second-coat) the Railing

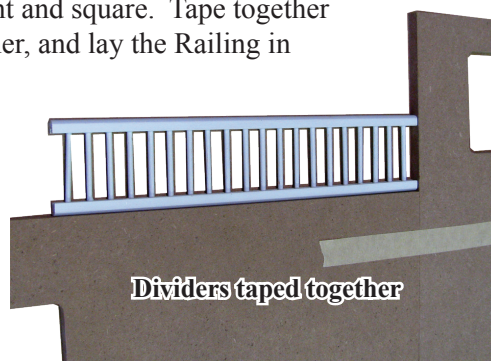

Dividers taped together

A Railing Assembly demo is available online at www.dhbuilder.com

If this diagram prints at a slightly different size than the original, center you rails on the layout, and still follow the Dowel placement

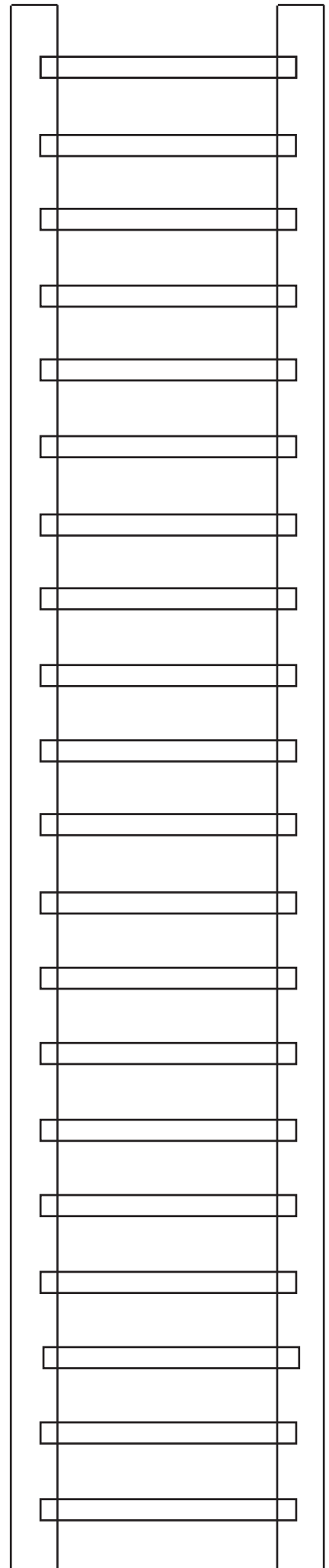

□ 56. Arch Rail Assembly: You may wish to remove this page from the instructions... there are many steps that have “let the glue dry” and you will want to skip ahead to other sections while you are waiting

- A. 1. Paint (first coat) and sand the Arch Rails, the 3/16” Stripwood, the 18” lengths of 1/8” Dowel, and the 3/8” beads.
2. Lay a Dowel on the Arched Railing diagram, lined up with one end of a dowel on the diagram. Press down with a utility knife on the other end of the dowel-length and roll the Dowel so the knife makes a cut all the way around. Snap off the Dowel at that cut. Make 4 Dowels of each length, and keep them organized by length (it is easy to confuse the shorter lengths)
3. Roll a little glue on the edge of one end of each Dowel, and glue it into a Bead. Twist the Dowel as you push it into the Bead to spread the glue.

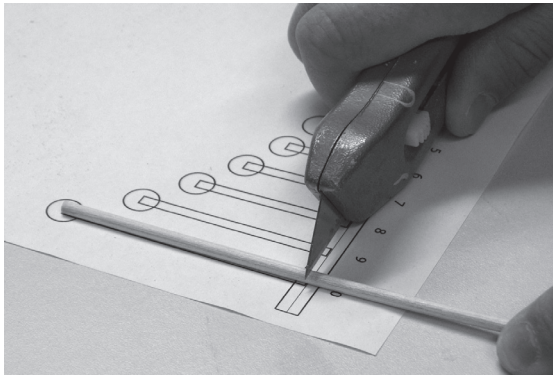

Note: This diagram will not print to scale on many printers. Compare the length of the printed diagram to your Arch Rail. If it is not the same, talk to your computer wizard or adjust the ‘scaling’ for printing a PDF file in your printer settings

- B. 1. Put the Arch Rail on its side on the diagram, lined up on the ends. Tape the Rail to the diagram so it won’t move.
2. Start with the shortest Dowel/Bead sets. Dip the end of a Dowel/Bead into a puddle of glue and push it into the Rail’s groove at the diagram’s location for that rail-length. Line up the Rail and Bead carefully with the diagram. Repeat for each length to the longest. You now have half of one Rail filled with Dowel/Beads. Adjust the parts to perfectly match the diagram and let the glue dry for a few minutes, then turn the diagram around and start from the middle again, filling the other side. Adjust the parts and let the glue dry.
- C. Cut two pieces of 3/16” Stripwood 10 1/2” (the same length as the Rail). Spread glue on the Stripwood and put it under the Dowels, lined up with the Rail on the ends, and spaced 3/16” from the Rail. Add a little weight and let the glue dry.
- D. Repeat all the above for the second Arched Rail.

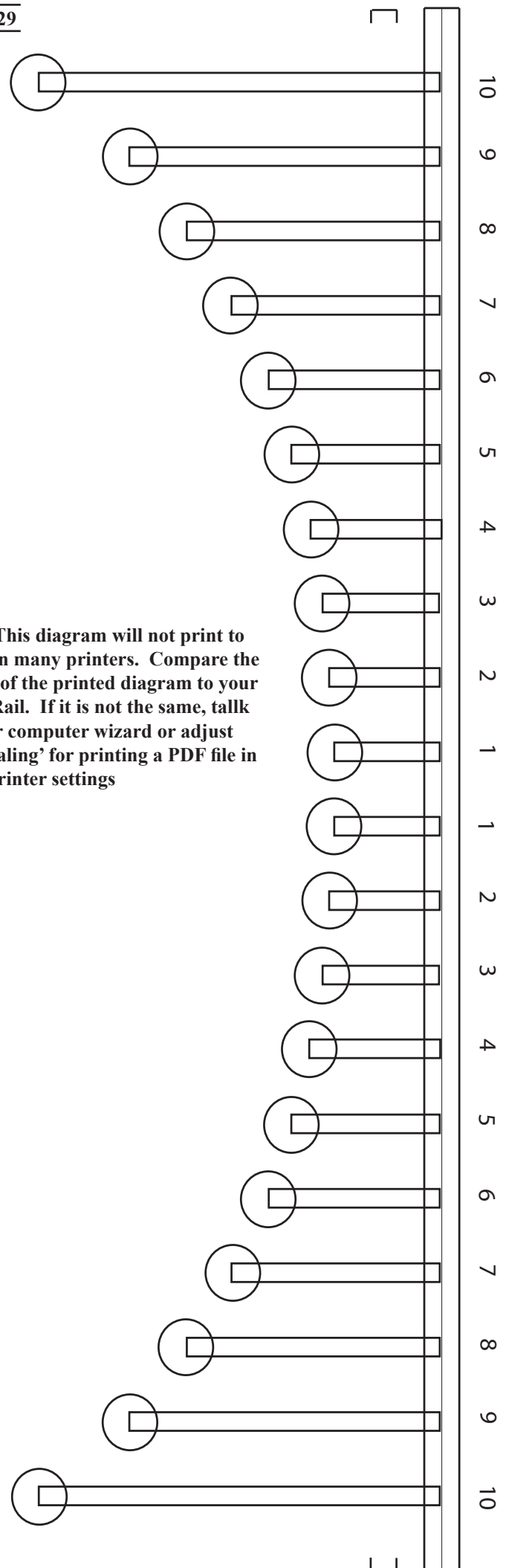

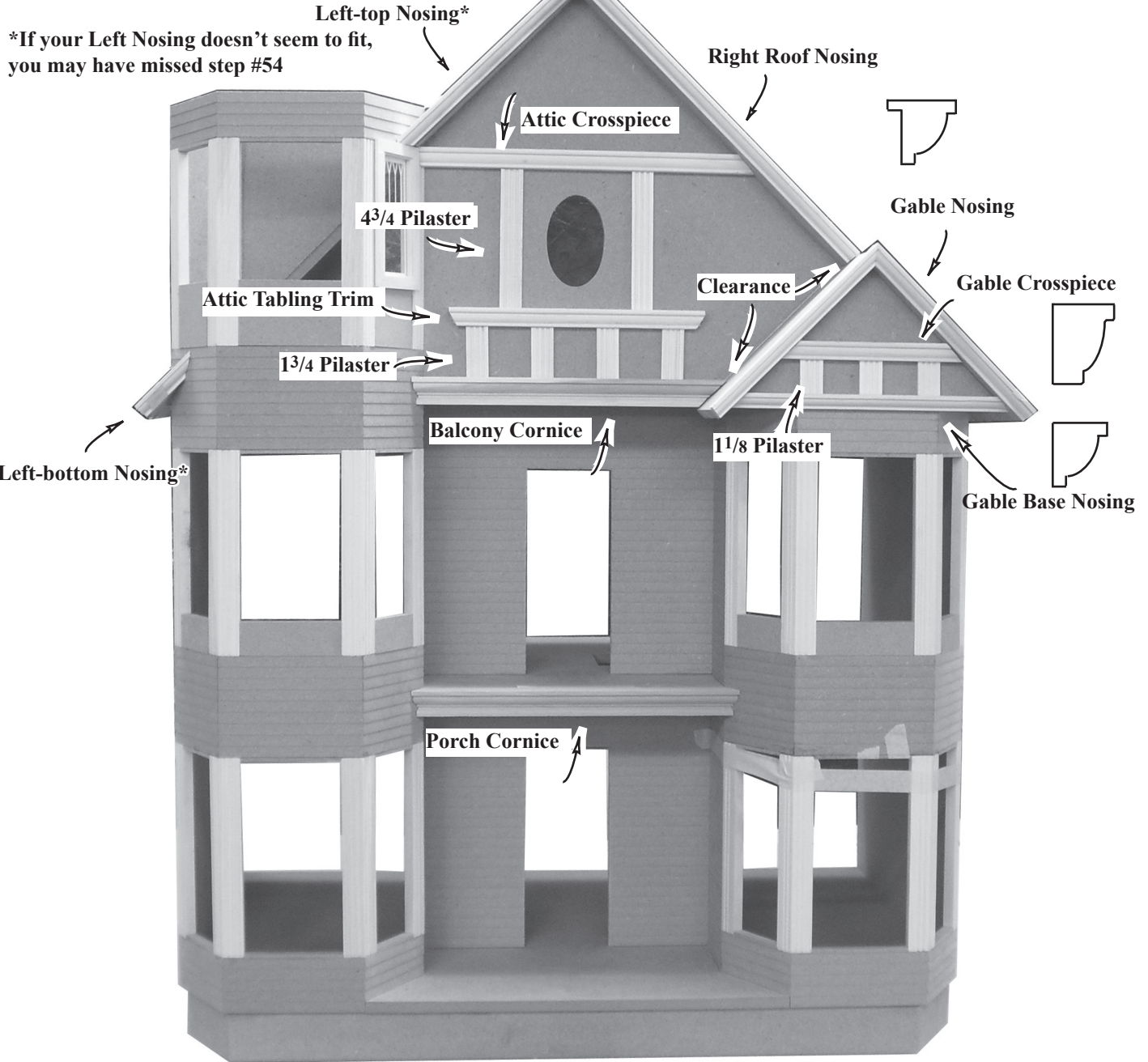

57. **Trim:** Lay the house on its back. Lay out the trim as shown, but without glue. The parts lay out from the bottom - up, but you will glue them on in reverse order: **from the top - down**. If your outside trim plan uses the Stripwood Trim (step #58), glue the molding trim on *after* you have cut and fit the Stripwood (step #60).

Notes:

- A. The Porch Cornice lines up with the Balcony Floor on top
- B. The Balcony Cornice lines up with the Balcony Ceiling on the bottom (If you shingled where the right end goes, some of the shingles may have to be carved or removed)
- C. Space the center-two 1 3/4" Pilasters 3/4" from the Reference line (step #35) and the outer two spaced 1 1/2" farther out (you can use the 3/4" width of the Gable's 1 1/8" Pilasters as the spacers).
- D. Center the Attic Tabling Trim on the Pilasters
- E. Center the 4 3/4" Pilasters over the spaces between the 1 3/4" Pilasters
- F. Space the 1 1/8" Gable Pilasters 1 1/4" apart
- G. The Right Roof Nosing has clearance at the bottom for shingling*.
- H. The Balcony Cornice touches the Tower and has clearance for shingling* on the right

*Consider shingling (Step #66) before attaching the Balcony Cornice and Right Roof Nosing

Erase the Reference line after gluing all the trim in place

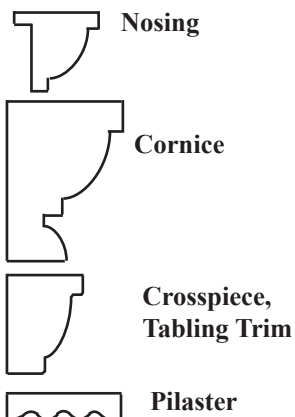

Pro tip: There are many ways to finish the outside of a true "Painted Lady" fancy shingles, sculpted plaster, fans, fleur-de-lis; the stripwood trim provided in this kit is only one of the techniques for you to consider as you finish your house

□ 58. Stripwood: Build a Miter Guide by gluing the kit's "Cutting Guide" to the Porch Spacer. One end will give you square cuts, the other is 45° (the roof angle)

Set aside (4) pieces of 1/2" Stripwood for the Side Trim (20 1/2") (step #60) and cut four pieces for the Porch (9 1/8") (step #63) before you start cutting the layered trim.

Cut and attach layered stripwood trim as shown, starting with the 1" Stripwood, then 3/4", 1/2" and finally 3/16"

Upper Attic Trim: 1", 3/4", 1/2", are the same length (measured on the outside edge)
Note: Every build is a little different and variations in the size shown in this diagram are expected.
Make your stripwood fit your house

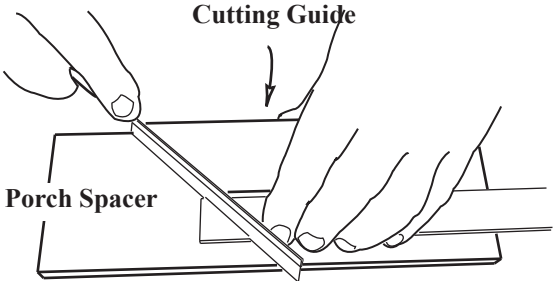
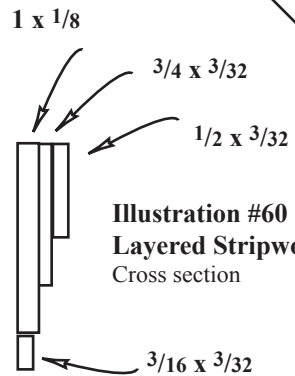
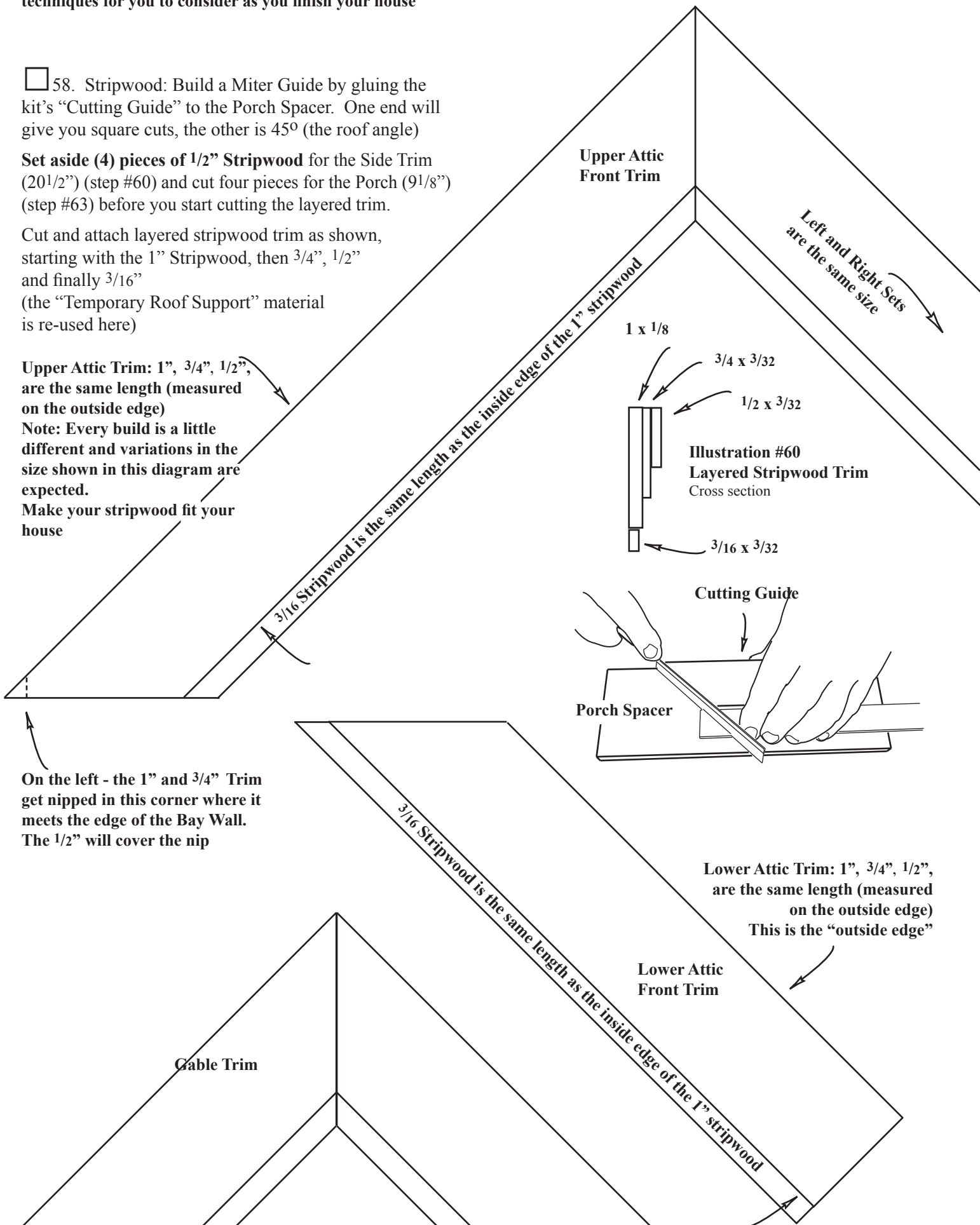

On the left - the 1" and 3/4" Trim get nipped in this corner where it meets the edge of the Bay Wall. The 1/2" will cover the nip

Lower Attic Trim: 1", 3/4", 1/2", are the same length (measured on the outside edge)
This is the "outside edge"

- 59. Install the Window Outside Frames and the Doors
- 60. Attach 1/2" Stripwood to the front and back edges of the Sides
- 61. Test, glue together, and attach the Window Ledge Set above the Left-Mid Bay Windows
- 62. Cut 3/4" Stripwood for the Block Trim between the Pilasters:
 (3) pieces 1" long for the Attic Front's Block Trim
 (2) pieces 5/8" long for the Gable's Block Trim.

- 63. Glue the Arched Rails to the Porch Ceiling and the Balcony Ceiling just behind the Cornice. Cut and attach 1/2" Stripwood to fit against the wall below the Arched Rail set.
- 64. Glue the Balcony Rail to the Stripwood and the Balcony Floor.
- 65. Attach the raised Panels centered below the windows and spaced about 1/4"

Optional: Glue on the Front Steps with or without the Step Back, centered.

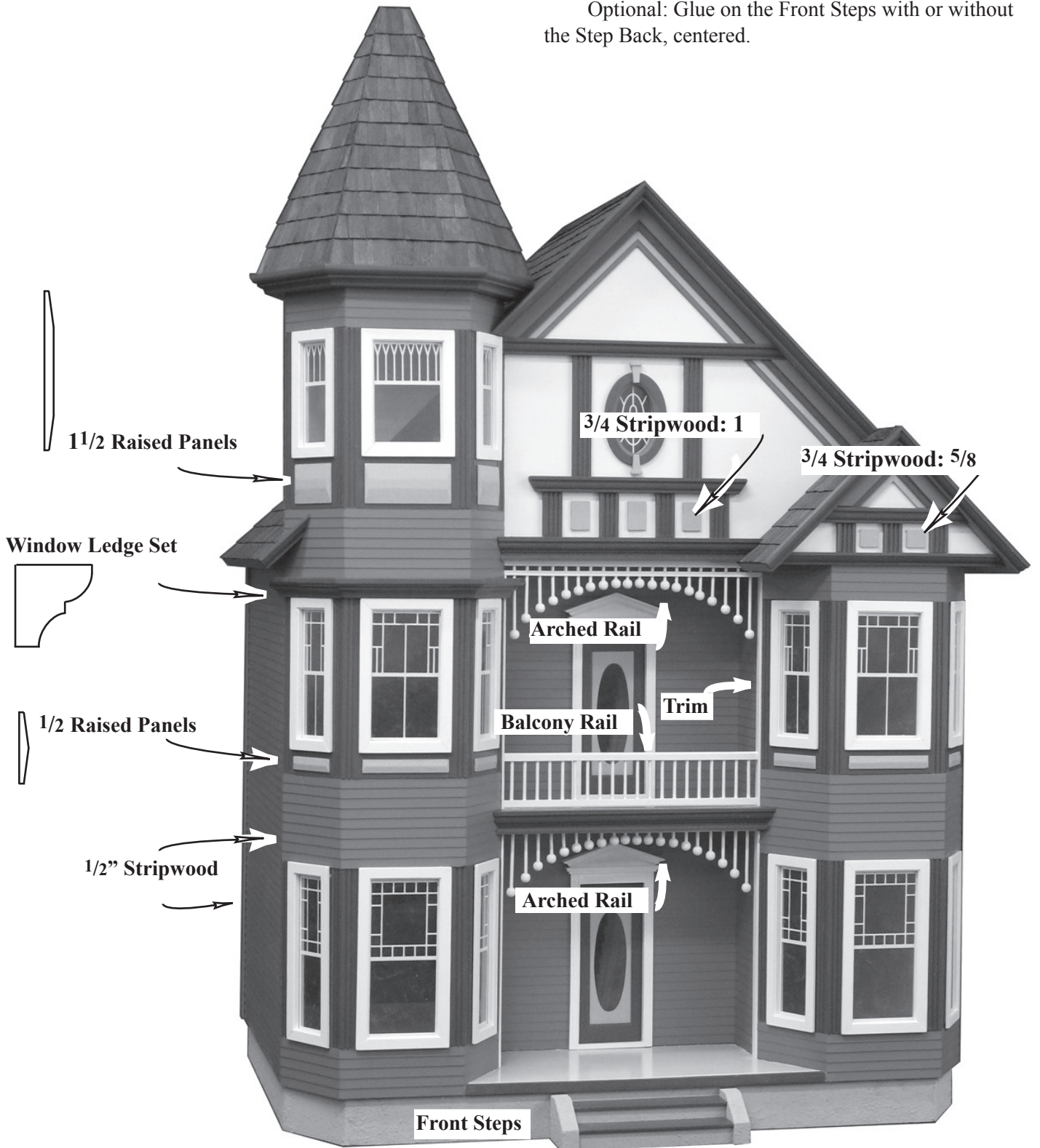

66. **Shingle the Roof:** Glue: Use a thick *solvent-based* (not “water clean-up”!) panel adhesive such as Liquid Nails[®]Macco available in caulking gun tubes at building supply stores. Trim just a little of the end of the tube for a tiny hole, giving a thin bead of glue. Always use good ventilation with solvent based adhesives.

Extend the shingle guidelines across the Eaves and across the Tower Back Roof.

A. Glue a “starter row” or 3/8” long Shingles square-edge down along the bottom edge of the Roof, or “Flash” the edge with a 1/2” strip of copper (#SC from *Real Good Toys* is available through your dealer) to prepare the bottom edge of the Roof for the first row of shingles

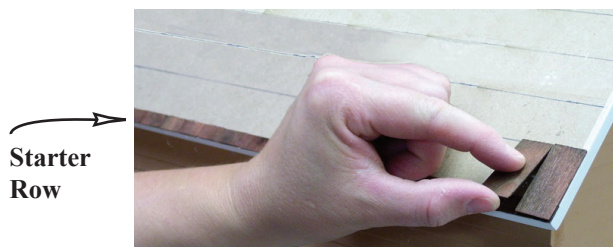
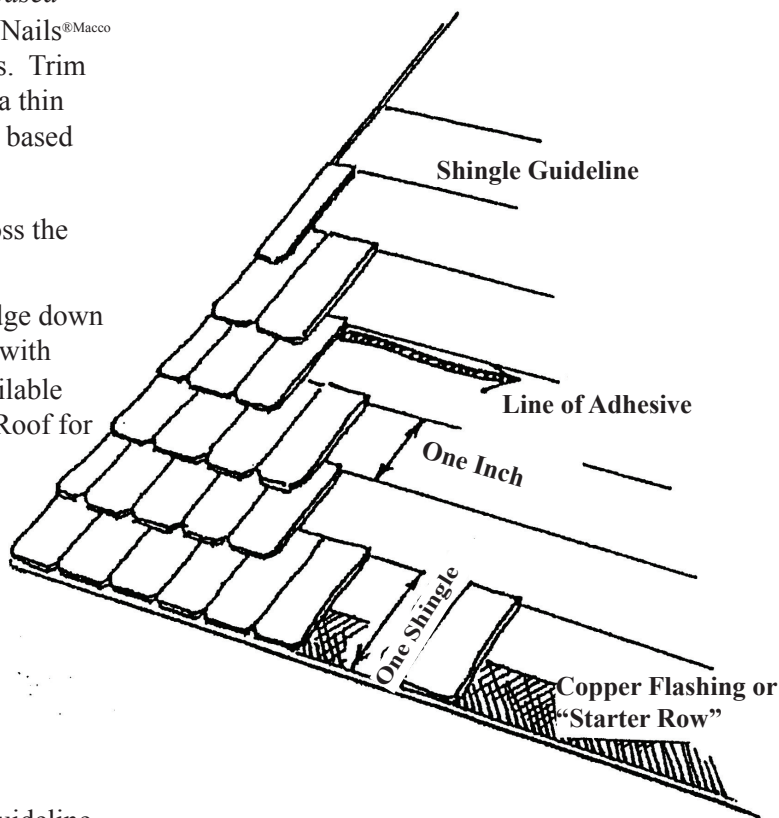

B. Apply a thin line of adhesive just below the lowest guideline all the way across one roof. Press the top edge of a Shingle into the line of glue, squeezing out the excess. Hold the first Shingle and press another Shingle into the adhesive, tight to the first. Hold the next Shingle and press in another... etc. all the way across the roof, cutting the last Shingle to fit

Continue up the roof one row at a time. Start the next row with a half Shingle so that the seam between Shingles is staggered back and forth as you go up the roof. Line up the top edge of each row (except the starters) with the guidelines.

Cut the top row of Shingles so that each row will have the same reveal. Finish the top edge with a “Boston Lap”: pairs of Shingles laid horizontally. Start at the ends of the peak, and, with each pair overlapping the previous pair, work to the middle.

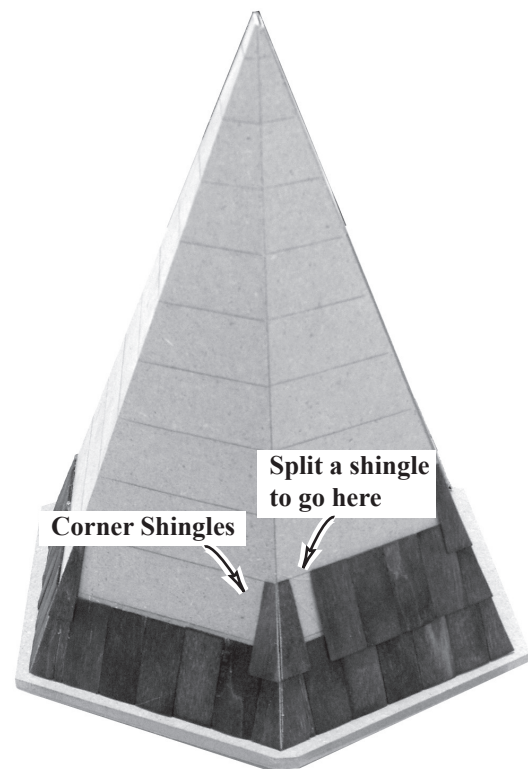

C. Cut angled shingles for the corners of the Tower Roof. When you glue a pair of shingles to the Tower Roof’s corner, the edge is straight up-and-down the roof. Start with the angle cutting guide and fine-tune your shingles; cut 50 pairs. For a course of shingles on the Tower Roofs, glue the Corner pair on first on both edges, and fill in the shingles between them, splitting a shingle for the narrow last space.

Corner Shingle
Cut with a saw to get two Corner Shingles from one flat Shingle (cutting with scissors splits one shingle of the pair)



Finish the Inside...Plan Ahead!

Interior finishing involves so many choices! Will this house be a play-house or a display for miniatures? What accessories will be used and where will they go? Wiring? Wallpaper? Tile or carpeting? Every choice makes a difference in the order of finishing. Real Good Toys has provided materials for some basic interior work, but you may choose to do it differently. Make your choices

Get your materials
Test your layout

With the pieces in your hands, imagine the steps to get to where you want to be.

Now you're ready for **your** order of interior finishing. Here's the order that our assembly pro follows for tackling most custom interior finishing:

- Dividers
- Electrical wiring (using "tape" style wiring)
- Wallpaper (using methylcellulose paste)
- Interior Window and Door Trim
- Stairs
- Flooring
- Baseboard and crown moldings

67. Window Interiors: The outside Frames were installed in step 59 along with other outside finishing. When the inside is ready for the window interiors (see "Plan ahead" at left), lay each window Frame on it's wide face and set a Window Pane the same size on it, painted face up, and lined up around the edge of the narrow face.



Tape the Pane to the Frame. Keep the tape close to the edge so it won't be visible thru the window when it is in the opening. Trim off the excess tape. Glue the Inside Frames into the window openings
Interior Door Trim: Glue together the Interior Door Trim (2 sets). When it is dry, glue and tape each set to a door, lined up on the inside.

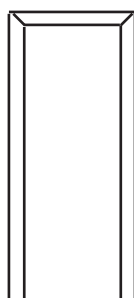

Illustration 67C
Interior Door Trim

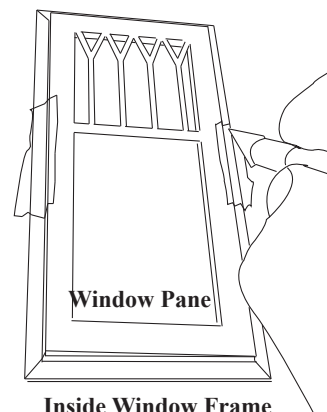

Illustration 67B

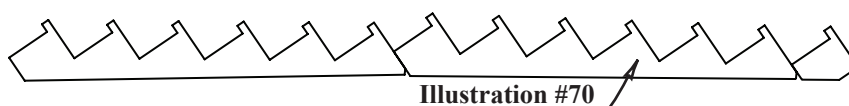
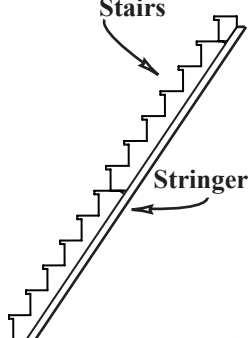

Illustration #70
Stairs

68. Set the Oval Window's printed Pane in the notch on the back edge of the frame. Install the Oval Window Interior Trim

69. Lay out Dividers without glue lined up with the stairhole; use other Dividers as "squares"... straight front-to-back and up-and-down. Mark their location. To glue Dividers in, apply glue, tip the Divider and put it almost all the way in, set the base, lift the next-higher floor for some clearance, tip the Divider upright, and slide it the rest of the way in place, clean-up the excess glue. The 1st floor Divider must have the doorway closer to the front and the 2nd floor Divider has the doorway closer to the back.

70. Assemble the Stairs: Lay a piece of tape sticky-side-up on the table. Glue and gently lay the Stair parts on the tape, lined up on the edges (Illustration #70). Stretch the tape and push down on the stair parts to stick them to the tape. Check the edges, add weight, and let the glue dry
Glue the Stairs to the floors and Dividers. Test then glue the Stringers to the back of each Stair



Glue on the Tower Roof after all interior finishing is done

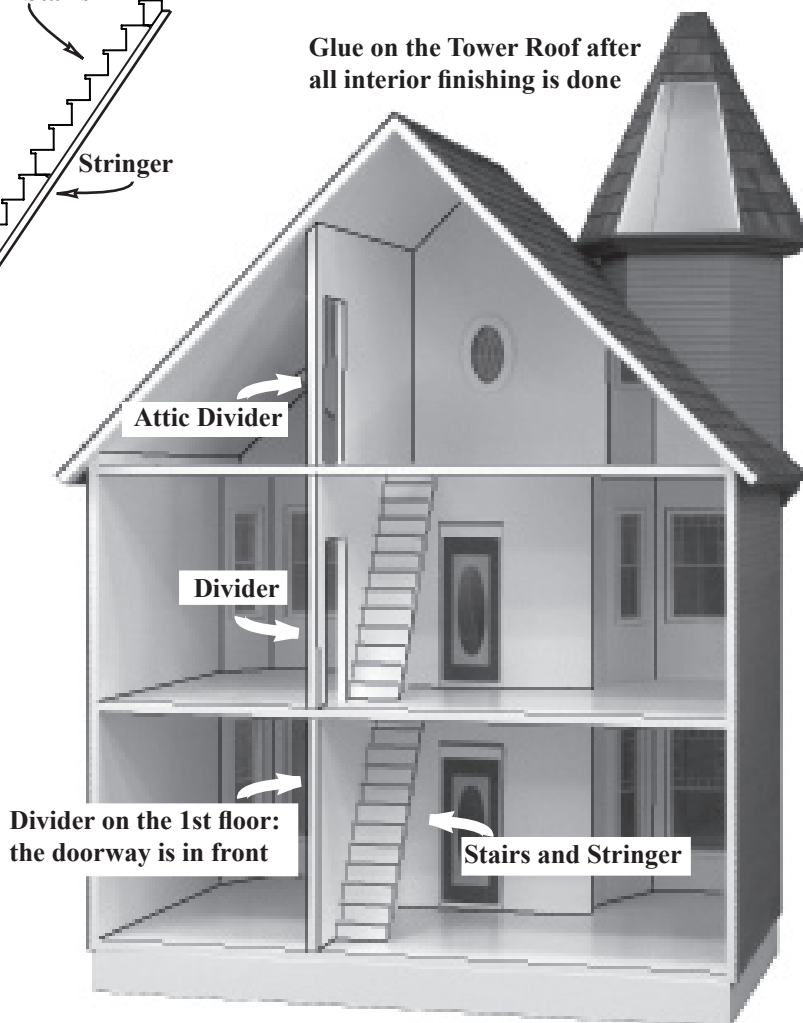

**That's it! You're Done
Congratulations!**