

Congratulations on your choice of a Real Good Toys product. Your kit has been precision made with meticulous care by our craftspeople using carefully selected materials. This Dollhouse will last for years, even generations, if heirloom care and attention is given during assembly. Take your time and read the instructions completely. If you have questions, ask the experts at your local Dollhouse store or at info@realgoodtoys.com

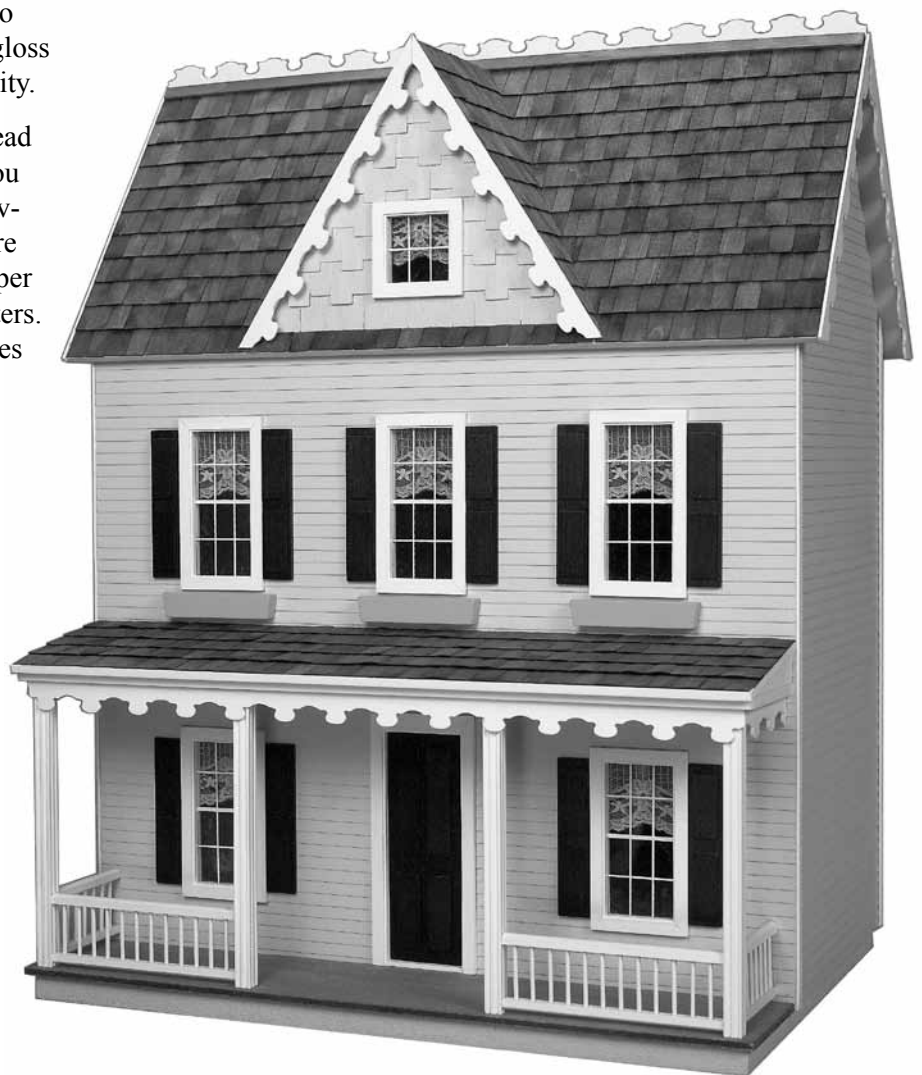
Before you begin - You have already opened the box and see all the parts organized in boxes and bundles. For the moment, keep them that way. There are important things to do before you open your glue bottle.

Choose your color scheme. Look at houses in your community, models in your local Dollhouse shop or at our website: realgoodtoys.com; look at plan books from a paint store or architectural books at your library (a favorite is: *Painted Ladies* by Michael Larsen and Elizabeth Pomada). You will be painting some of the parts right away so get the paint now. Choose high-quality semi-gloss latex enamel paints for ease of use and durability.

Prepare your space: This dollhouse will spread out over a large area while it is being built. You will need a large flat tabletop for the house, several boxes to keep parts organized until they are needed, and several trays lined with waxed paper for holding small parts like windows and shutters. A snap-lid box will keep your tools and supplies handy between building sessions.

Measure and identify the parts: The kit is packed in groupings that protect the parts, and that is how the Parts List is organized. As you measure and identify the parts, label them with sticky notes using the names from the parts list, and check them off the parts list so you know you have everything. Taking the time now to identify and organize the parts also makes them familiar so you will understand what the instructions intend as you read ahead.

- Plan ahead so you know where you are going
- Read ahead so you know how to get there
- Paint ahead so the parts will be ready when you need them



Tools and Supplies:

Tape measure or ruler, Pencil, Sticky notes (like PostItts®)
White glue (like Aleene's Tacky Glue®) for all construction
Solvent-based Panel Cement for shingles
Masking tape, Utility knife or coarse file
Fine tooth saw (razor saw (like X-Acto®) or a hacksaw)
Painting Supplies, Sandpaper (especially 320gr) Waxed paper

PostItts®, Aleene's®, and X-Acto® are registered trademarks of their manufacturers and have no affiliation with Real Good Toys

Not suitable for children under 13 years of age
California 93120 compliant for formaldehyde phase 2



www.realgoodtoys.help

Options for building the Vermont Farmhouse Jr. Dollhouse

See your local dollhouse shop or www.realgoodtoys.com

Exterior:

Exterior Paint Color:

see www.realgoodtoys.help for suggestions

Accessories:

- Gingerbread
- Flower Boxes
- Foundation Stucco Grit
- Octagonal Shingles
- Fancy Windows and Doors
- Turnposts and Spindles

Interior:

- Wiring
- Wallpaper

Interior paint color:

- Ceilings
- Painted walls
- Interior trim

Flooring:

- Applied wood, tile, or carpet
- Banister & Landing Rails
- Window and Door trim
- Baseboard and Crown



see page 18

JM-66 Conservatory
12 x 12 x 14T

JM-44 Colonial Addition
12 x 12 x 21T

C50 Chimney



Windows: Openings fit: full-size; working or non-working



JQ13W



#5042



#5041



5025
Louvered
Shutters

Split Octagonal Shingles

Cedar: HOC350

Pine: HOW500



Doors:

Exterior

Interior



#6002



#6018



#6022



#1015

Note: I often enlarge an interior door opening to fit the #6022

Shingle Dye

- Dye1: Reddish Brown
- Dye3: Dark Grey



Stucco Mix



T-10
Turntable



T250 Assembled Turntable

- T10: 12" Turntable
- T250: Assembled Turntable
- ET250: Wired Turntable

A Dollhouse for your Dollhouse



6452M: Cherrydale Mini



6448M: Kiwi Mini



DH

A Doghouse for your Dollhouse

Wallpaper

P2000
HH444



RGT5
Porch
Post

Trim and Stripwood

Flute24

SW16

RGT8
Spindle



Real Good Toys' *Best!*
Dollhouse Wiring Set



SW16



E226



E225



E224

Tapewire or Roundwire powered
"Light-It-Up" LED Lighting

Battery powered LED Lighting



HW2301



HW2326

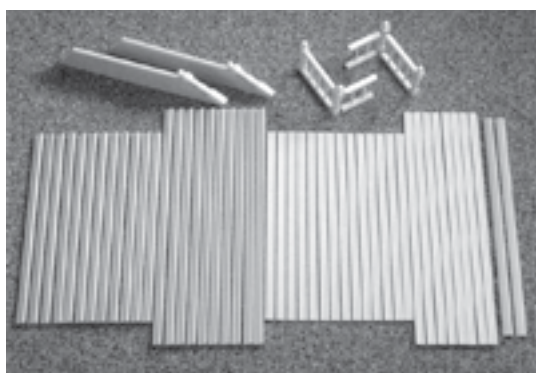


#4017 Pine Stair
and Landing Set



6803 Banister
& Landing Set

J-FK
Banister/Newel
Turned Landing Rails
Baseboard Molding
Crown Molding



Tools, Accessories, Supplies, and Miniatures:
visit www.realgoodtoys.com

Identify the parts: Open one bundle at-a-time.
 Measure each part and find it on the parts list.
 Label the parts with pencil or a sticky note.

The Woodgrain Flooring, Assembled Door, Sawn Shingles, and other extras make this a **“Special Edition” Kit**. In any correspondence include the words **“Special Edition”** so we can help you properly.

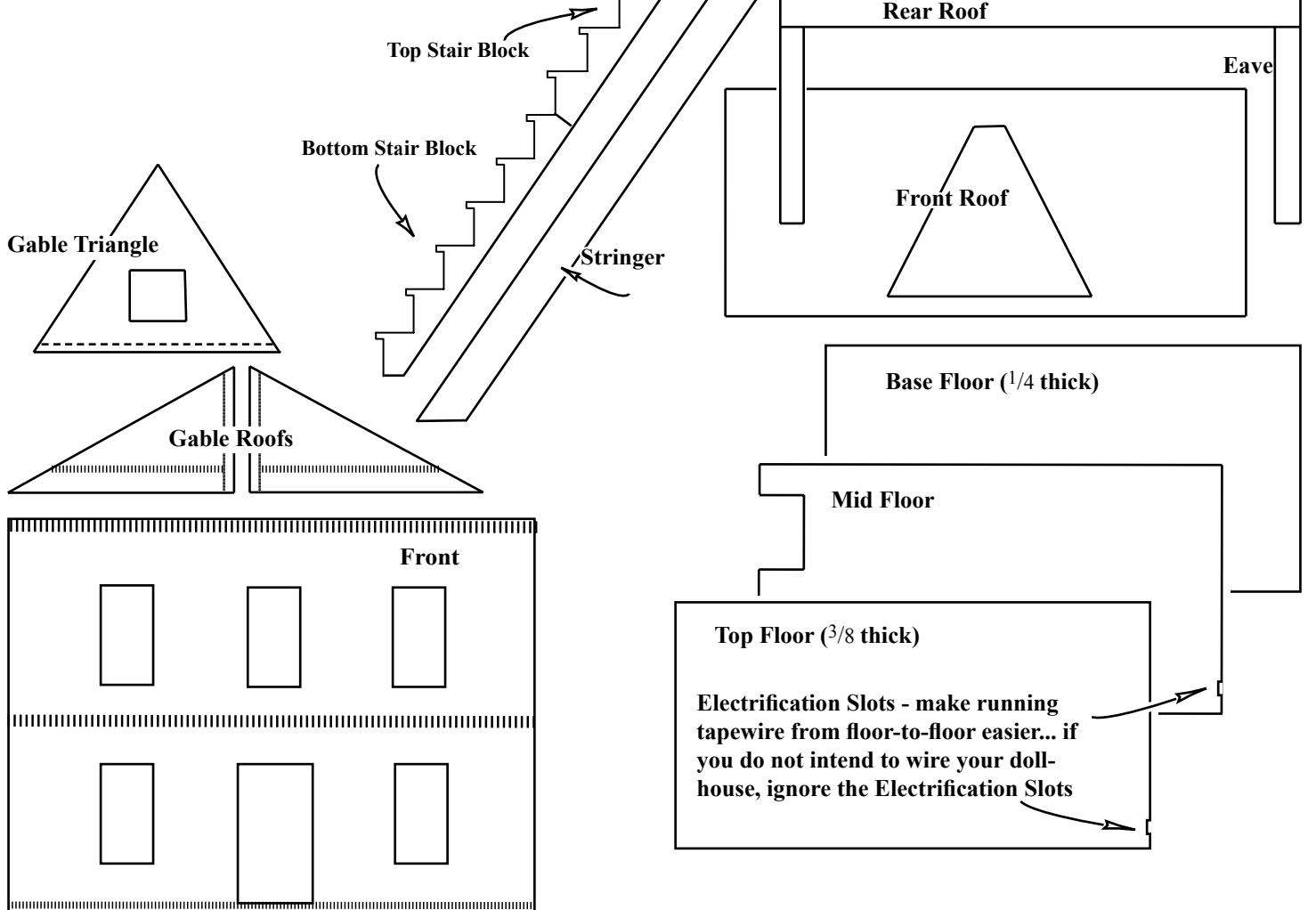
<https://www.realgoodtoys.help>

Parts List: Measurements are approximate and are for identification purposes only.

- (2) E3606 Side Panel: (3/8) 27³/₄ x 11³/₄, Grooved
- (1) E3607 Front Panel: (3/8) 19 x 22¹/₂, Windows/Door, Grooved
- (1) E3608 Front Roof: (1/4) 23⁷/₈ x 11¹/₂, Gable Cutout, Beveled
- (1) E3604 Porch Floor: (1/4) 22¹/₂ x 4¹/₂
- (1) E3605 Porch Roof: (1/4) 22¹/₂ x 5
- (1) E3637 Cresting Gingerbread: (1/8) 24
- (2) E3629 Foundation: (1/2) 3/4 x 16³/₈, mitered
- (2) E3630 Foundation: (1/2) 3/4 x 22, mitered
- (2) E3631 Foundation: (1/2) 3/4 x 15³/₈

- (1) E3713 Porch Gingerbread - 22¹/₈
- (1) E3609 Rear Roof: (1/4) 23⁷/₈ x 1³/₈, Beveled
- (2) E3627 Porch Trim: (5/16 pine) 5/16 x 22¹/₂
- (4) E3628 Stripwood: (3/8 pine) 3/32 x 20¹/₈
- (1) E9803 Stringer: (1/8 x 1³/₁₆) = 10⁷/₈

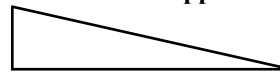
- (1) U-E3601 Base Floor: (1/4) 22 x 11⁷/₈
- (1) U-E6412 Middle Floor: (3/8) 22 x 11⁷/₈, Stair hole
- (1) U-E3603 Top Floor: (3/8) 22 x 11⁷/₈
- (2) E3610 Eave: (1/4) 1³/₈ x 10
- (1) E3611 Gable Triangle: (3/8) 7⁷/₈ x 10¹/₈, Window Cutout, Bev.
- (1) U-E3612 Left Gable Roof: (3/8) 10³/₁₆ x 6¹/₈, Bev., Grooved
- (1) U-E3613 Right Gable Roof: (3/8) 10³/₁₆ x 6¹/₈, Bev., Grooved
- (2) E3614 Attic Partition: (3/8) ±8³/₄tall Triangle
- (2) E3615B Divider: (3/8) 9 x 11³/₄, Door Cutout
- (1) E3623 Groove Fill: (3/8) 1/8 x 4



- (1) E9801 Bottom Stair Block: (6step) 2¹/₄
- (1) E9802 Top Stair Block: (6step) 2¹/₄
- (4) E3619 (1/2) Post: 9 tall
- (2) E3620A – Assembled Side Rail: 3³/₄
- (2) E3621A – Assembled Front Rail: 6¹/₄
- (4) E3624 Porch Support Triangle: (3/4) 4¹/₂ x 7/8
- (2) E3625 Triangle Spacers: (3/8) 1³/₁₆ x 6¹/₈



Porch Support Triangle



Note: Porch Triangles are wrapped and may not look like this until they are un-wrapped



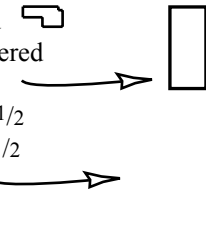
E3713 Porch Gingerbread



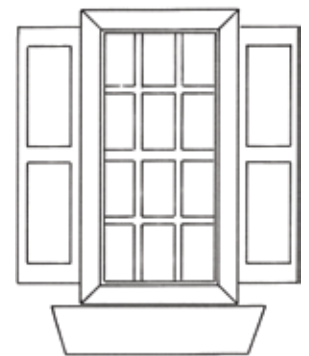
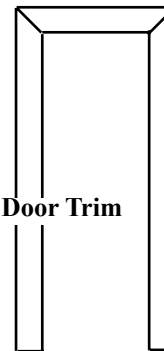
E3637 Cresting Gingerbread

Windows:

- (20) T1020 Vertical Frame: 5⁵/₁₆, mitered
- (28) T1021 Horizontal Frame: 2¹³/₁₆, mitered
- (20) E3633 Shutter Panel: (3/4) 3³/₃₂ x 1⁷/₈
- (5) T1022 Standard Printed Plexi: 5 x 2¹/₂
- (1) T1023 Small Printed Plexi: 2¹/₂ x 2¹/₂
- (10) E3632 Shutter Core: (1) 1/8 x 4⁵/₈

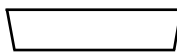


Interior Door Trim



Door & Interior Trim:

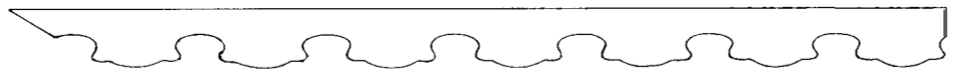
- (1) 6042 – Assembled Door
- (2) T0558 Interior Side Door Trim
- (1) T0559 Interior Top Door Trim
- (3) E3626 Flower Box: (1/2) 3/4 x 3³/₄



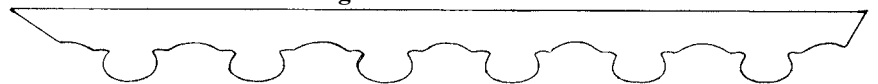
Eave Gingerbread

Pre-cut Gingerbread:

- (2) E4152 Eave Gingerbread - Left
- (2) E4153 Eave Gingerbread - Right
- (1) E4154 Gable Gingerbread - Left
- (1) E4155 Gable Gingerbread - Right
- (1) E4150 Porch Gingerbread - 4¹/₄ - Left
- (1) E4151 Porch Gingerbread - 4¹/₄ - Right

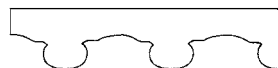


Gable Gingerbread



Roof Shingles:

- (1) E3638 Bag of Shingles (800)



JM-401 with two JM-44 Additions

Finish the Floors with clear acrylic urethane like StaysClear[®] Benjamin Moore to protect them from damage. Wipe off the first coat to leave it thin and un-beaded. When dry, rub the surface with a non-woven abrasive pad (“synthetic steel-wool”) or a crumpled brown paper bag to take off the shine, then put on another coat. Do not use penetrating stain.

www.realgoodtoys.help

Foundation Paint: For the show models we assemble here at Real Good Toys, we paint the Foundations and Steps with one coat of regular paint, then a coat of paint mixed with Stucco grit. Keep the mixture well stirred and apply with a foam brush in short swirls or slaps.

Overview of the Build:

Details of each step will be expanded along the way, but lots of folks like to see how it all fits together before they start

Identify and label all of the parts
 Preassemble the Foundation, Rear Roof, and Stairs
 Paint everything one coat
 Finish the floors
 Sand everything until the paint is smooth, transparent, and some of the wood is showing through
 Build the housebody up to the Roof
 Second-coat the Walls
 Mark, paint, and attach the Roofs
 (don't glue on the Rear Roof yet)
 Optional: Start the wiring
 Foundation
 Install the Dividers
 Optional: Finish the wiring
 Assemble and finish painting everything else
 Finish the Attic - attach the Rear Roof
 Finish the outside
 Finish the inside

Wiring? www.realgoodtoys.help

Click the buttons "JM401" and then "Wiring" for wiring information specific to this house.

Assembly Tips:

A large, clutter-free, well-lighted work area is helpful during assembly, but a flat work surface is essential.

Read the instructions carefully; look at each of the illustrations. **!With the parts in your hands!**, think the assembly through before you proceed.

Test fit each time you are ready to glue a piece in place...then you'll know you have it right.
 If more tape or a helper is needed, it's good to know that before the parts have glue on them.

Don't be stingy with glue or tape; use generous amounts. Always wipe off excess glue immediately. Keep one damp rag and one dry rag handy all the time. Have weights available for holding things tight as glue joints dry (stacks of books, gallons of pure Vermont Maple Syrup - anything heavy)

Glue the body of your dollhouse together with white, water clean-up glue that dries clear. Do not use instant-bond (super glue), fast-tack, rubber cement, silicone, or hot melt glues. They are all used in some wood applications, but they all have some characteristic that makes them un-desirable for the body of your dollhouse. Carpenter Glue works well, but glue-smear dries yellow or tan; many of the things you glue onto the house are pre-painted – extra glue will show.

I use Aleene's Tacky Glue® for housebody assembly (available at www.realgoodtoys.com).

Make sure everything is straight and flat as glue dries... That's the shape that will be permanent.

Slideshows, demos, useful links, details, and photos are all at:

www.realgoodtoys.help

Glue the shingles on with glue that doesn't have any water in it! If the glue says "water clean-up", it will curl the wooden shingles. Look carefully at the glue you intend to use to be sure it is solvent-based, or use hot-melt glue (use the high temp version and watch out for the burns). I use a "Sub-Floor Adhesive" glue which comes in a caulking-gun tube at the hardware or building supply store. It says "Caution: Flammable" on the front, and that's how I am sure it is *solvent based*. Check ingredients and warnings!

If you Wallpaper, use Grandma Stover's www.realgoodtoys.com or pre-mixed Roman's "Border" paste.

Brush paste on the wallpaper, then the wall, and finally smooth the wallpaper into position.

Taking things apart: Heat softens glue. If you have to take things apart, warm the part in the oven at 170° for up to a half hour to let the heat get into the joint where the glue is. Don't let it get hotter than you can touch or the paint may scorch. Don't heat window panes. www.realgoodtoys.help has more info.

When glue is drying, skip ahead to up-coming assembly steps and prepare the parts that will be used

Before you begin, read the "Finish the Inside" section at the end of these instructions.

Q: Can I wallpaper before I assemble the doll house?

A: Yes you can (it's your house!) Many experienced builders are advocates of papering before construction - I am not.

My biggest objection to papering first is that you are always too skimpy with glue so none will squeeze out and get on the paper. I try to use the amount of glue that fills the joint, so some will squeeze out in every joint and be wiped up. But wiping glue off of wallpaper leaves a streak, so the temptation is to go skimpy, and the joints aren't as strong.


Second, I can always tell a house that was pre-papered because the corners show a void instead of being continuous (see the slideshows about how to crowd the papers together in the corner... you can't do that with pre-papered walls).

Third, I have had to replace paper too often that has gotten damaged by glue or tape during construction... that wastes time and paper (\$) and can make it so you are left deciding whether to replace a damaged paper or letting it slide because you don't have any more of that pattern and you'll have to order it and that takes too much time (running out but then needing another piece is a distressing moment).

Finally, I don't find pre-papering to be faster. By the time I have done all of the extra planning that getting the papers in the right place requires, I have used up any potential advantage. I have great big blacksmith's hands, and papering in a finished house is easy for me.

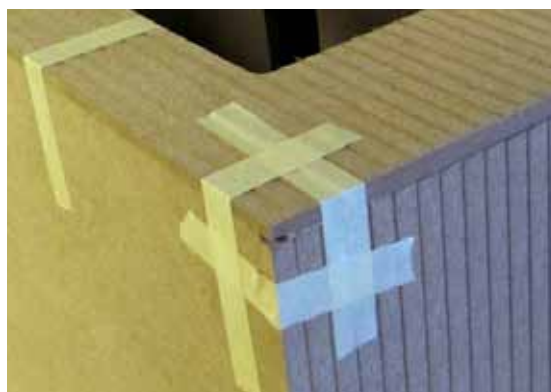
All that having been said, I do pre-cut the papers used in the attic before attaching the Roofs.

Masking tape is a great universal puller for dollhouse assembly, here's how to get the best out of it:

- a. *Use a sticky yellow tape*, not the easy-to-remove painter's tape.
- b. *Use enough tape* so you can start a distance from the joint and rub down several inches on the end, then...
- c. **Stretch** the tape as you pull it across the joint.  **Rub** the tape down so it will remain tight while the glue dries.
- d. **For more pull**, put on two thicknesses at the same time, or even three.

Wood always reacts to uneven moisture from paint or from having one surface exposed to the open air and the other facing a table top. It is part of the dollhouse builder's art to straighten reactive wood as you are building, and masking tape is your first and best tool. Many layers of tape will tighten or flatten even the most misbehaving panel, and it's normal to stretch bands of tape all the way around the house to hold the joints tight as the glue dries.

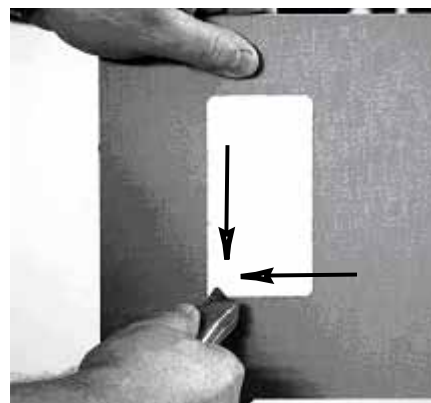
Don't be shy when using masking tape!



3-way tape on the corners

A: Getting Started: Do these things before the house assembly

Square the corners of the window, door, and stair holes with a utility knife - each cutout has a rounded corner left over from the tool that made it. Make two cuts in each corner from the outside (one from each direction), then cut from each direction on the inside to cut away the rounding in the corner so the window, door, or stairs will fit.



A Double-Cut Coarse file is easier for many people to use when squaring the corners. Make several strokes from each direction in each corner and test the Window or Door to see how it fits.



Stain the Shingles: Our pro uses Real Good Toys' Shingle Dye (available at www.realgoodtoys.com or through your Real Good Toys miniature dealer) when dyeing the shingles for this house. Batch dye or stain the shingles several days ahead of time so they will be dry when the time comes to use them (instructions are with the shingle dye).



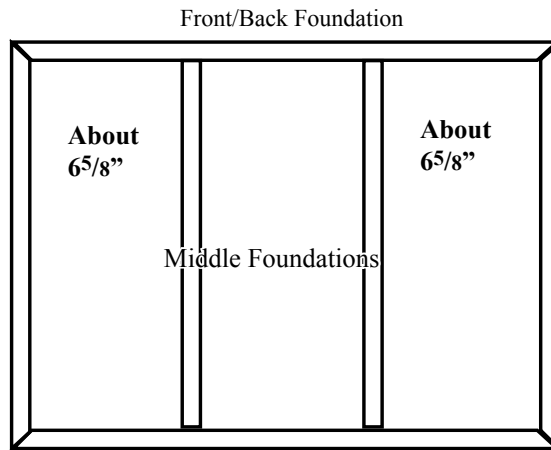
Demos and slideshows are at: www.realgoodtoys.help

Can I do it differently? *Yes you can - but:*

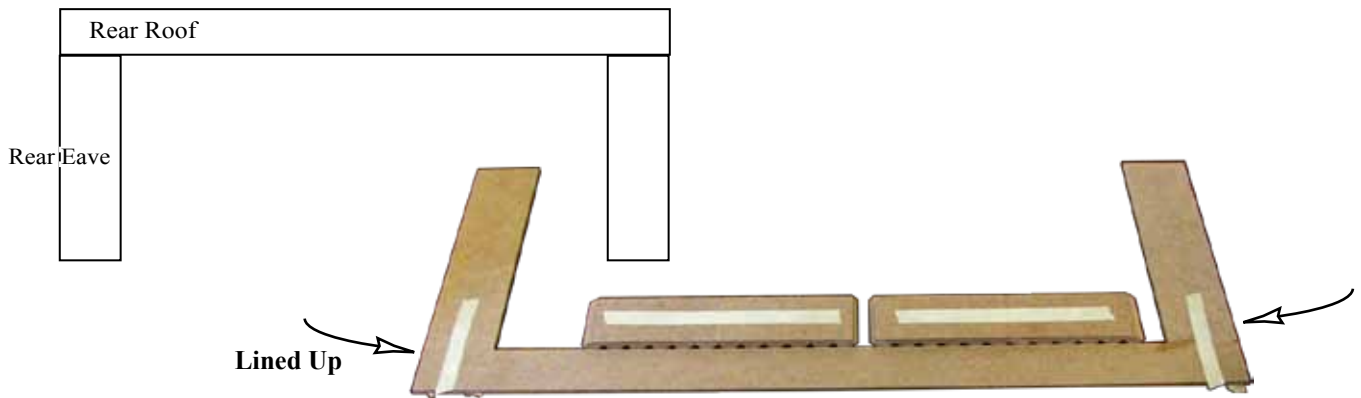
The information on these pages is offered as "best practices" advice, and it is what we do when we build this house. But if you are customizing or have something else in mind, go ahead!... just test-ahead to make sure your planning includes *everything!*

B. Pre-Assembly

Glue and tape together the Foundation set.

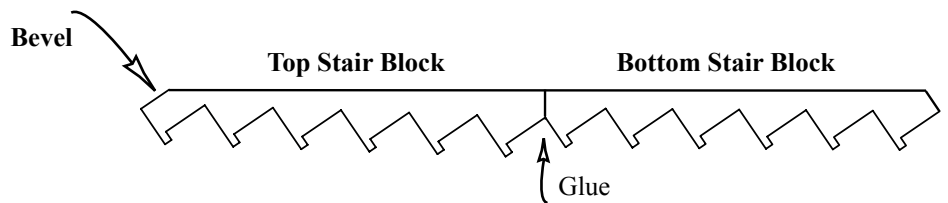


Glue and tape together the Rear Roof and Eaves.



In the photo above, the Rear Roof is used as a straight-edge for checking that the Stairs are straight as the glue dries.

Glue and tape together the Interior Stairs.



C: Painting: The order of assembly and painting is a back-and-forth process of test-assembly, marking, painting, and final assembly. There are three things to keep in mind as you do this:

1. **The quality of your paint job depends on sanding after the first coat**, and sanding is easiest and best while the parts are un-assembled.
2. **Glue doesn't stick to paint.** It does, however, stick to a part that has been first-coated and sanded. For this reason, parts that will be the same color can be glued together after one coat and sanding, but before the second coat of paint is applied.
3. **Where different colored parts will be glued to each other**, the neatest result will be achieved if the parts are marked and painted to just cover the mark, leaving the rest of the joint un-painted. That way, when they are glued together, the glue joint will have wood for strength (glue doesn't stick well to paint), and the joint between colors will be perfect (impossible to achieve with masking for painting).

Painting: www.RealGoodToys.help has painting and sanding videos

A word about primer: Primer is designed to help paint stick to an impervious surface or to join layers of dissimilar paints. In *this* application, the first coat of paint soaks right into the wood and fills the grain - you *could* do that with primer, but its job of being an interface between different materials doesn't apply here. In *this* application, primer just adds steps and expense. I don't use it under exterior colors, but I *do* one-coat and sand the interior walls and ceilings before assembly, and primer is a good choice for that.

Paint the parts the first coat. The first coat mostly soaks into the wood, filling and reinforcing the grain so the sanding step clips off the fibers and leaves the surface smooth. Resist sanding before painting - it will leave the surface fuzzy and make a smooth finish harder to achieve. The quality of your final finish is dependent on the quality of the sanding after the first coat. Do not go back to re-paint just because the paint has soaked in. Just a bit of paint left on the surface tells you you have put on enough to saturate the grain, which is the right amount. More paint than that will only make sanding harder.

Glue doesn't stick to paint. Avoid painting edges, grooves, and areas that will be glued.

Paint the walls on both faces. Paint the Upper Floors on the bottom face (the ceiling).
Paint the Trim on one face and both edges.

Sand everything. Sand until the paint is smooth and "soft" feeling, transparent, and some of the wood is showing through. Sand the Clapboard one-clapboard-surface-at-a-time. Fold the sandpaper and sand back and forth until the surface of that board is smooth and transparent; then move on to the next board. Fold the sandpaper as needed to keep it fresh.

Paint the second coat. The Second coat for the outside of the Walls should be done after assembly of the housebody and before attaching the Roof. The second coat goes on smooth and creamy with enough paint on the brush so it is quiet while you are brushing the paint out, but not enough to leave puddles or drips.

Clean the edges and grooves before assembly. A little paint always builds-out the corner of an edge or groove and will make assembly harder and the glue joint less strong. Test the Floors in their grooves to see that they fit well.

Cleaning a groove with a Cabinet Scraper



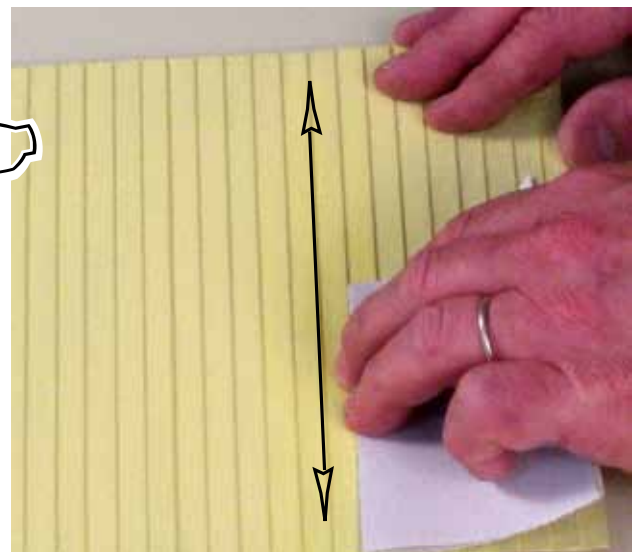
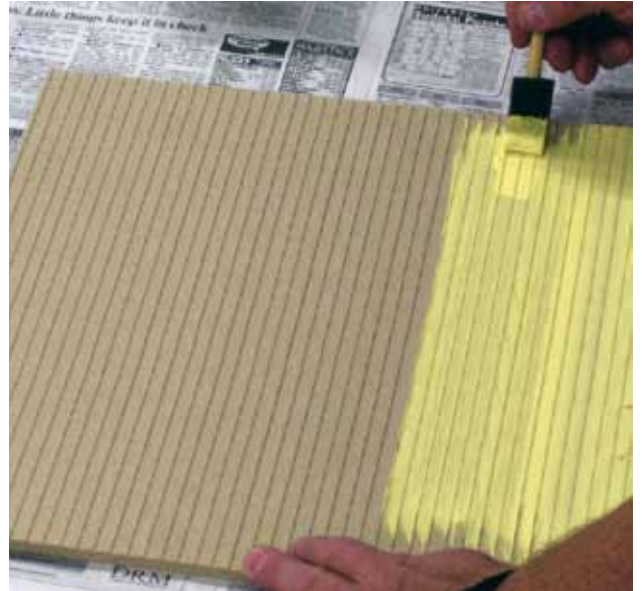
Cleaning a groove with a knife



Cleaning an edge with the back of a utility knife blade



Do not stack painted parts - even when they feel dry they will stick and damage each other. Keep them spread out or separate them with waxed paper.



Assemble the Housebody

Important! Finish the floors (see page 5) or be *very gentle* when you remove masking tape from the printed floors! Slowly, slowly rub the tape off or pull the tape at a flat angle (fingers touching the floor) with the direction of pull in line with the 'floor boards'.

Wiring? It's easiest to do some of the wiring steps now. Visit www.realgoodtoys.help and click on the buttons "JM401" then "Wiring" for wiring information specific to this house.

www.realgoodtoys.help has photos of finishing the floors

1. Select the Middle Floor. Without glue, test the Floor panel along with the Sides to check the fit (Illustration #2), and to identify the position of the stair hole, closest to the right-front corner (Illustrations #4A & 4B). Paint often hangs over the corners of the grooves and, without being noticeable, narrows them. Paint and floor finish also make the floors thicker. If the floors are too tight, scrape the sides of the grooves with the back of your utility knife, and scrape a bit of the bottom of the floor where it goes into the groove.

Complete steps 2 - 9 without stopping

2. Spread glue in the grooves of one Side panel (Illustration #3). Use plenty of glue and spread it lightly with your finger to keep it from dripping (if the glue is too runny, wait a bit for it to tack).

Now is a great time for an extra pair of hands.

3. Stand the Middle Floor on end (check the orientation again) and set the Side panel over the Floor in the middle groove. Repeat for the Top Floor in the top groove

4. Adjust and check all the parts. The Floor must be flush at the back edge of the Side panels ("flush" means 'forming a continuous, unbroken surface'). The Floor overhangs the front of the Side panels by 1/8" (Illustrations #4A & 4B).

Glue & tape the walls to the Floors.

5. Very carefully turn the Side/Floor assembly over. Glue & tape the other Side panel to the upper floors.

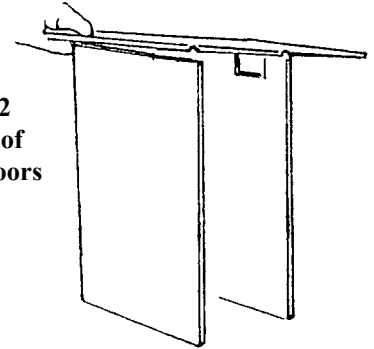


Illustration #2
Check the fit of the Upper Floors and the Sides

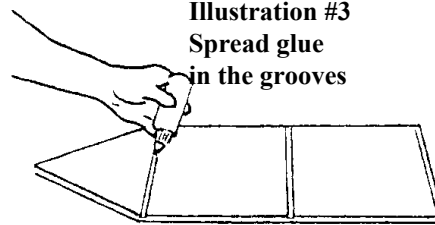


Illustration #3
Spread glue in the grooves

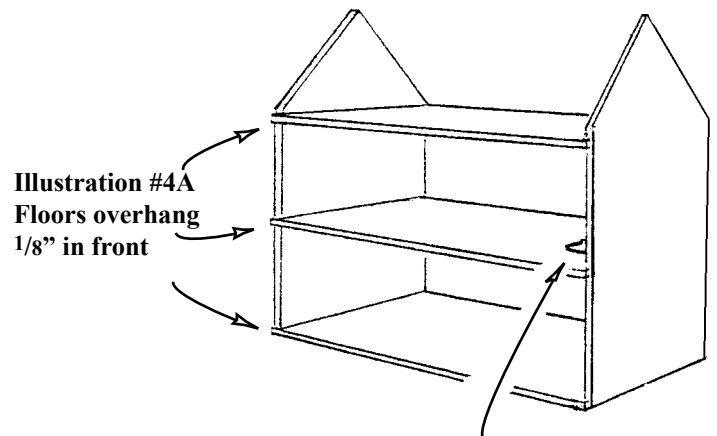


Illustration #4A
Floors overhang 1/8" in front

The Stair hole is closer to Front-Right!



The Floor sticks out 1/8" in front

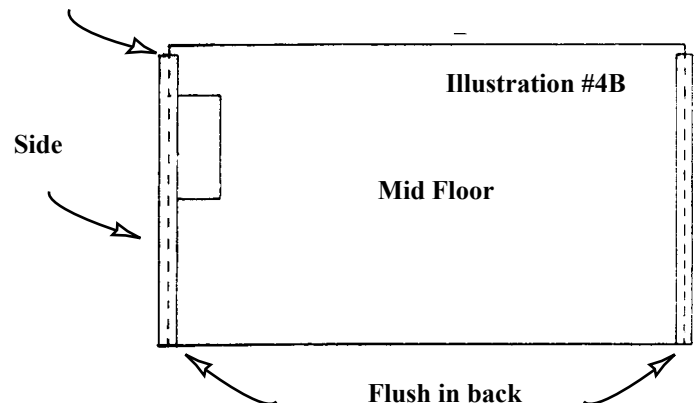


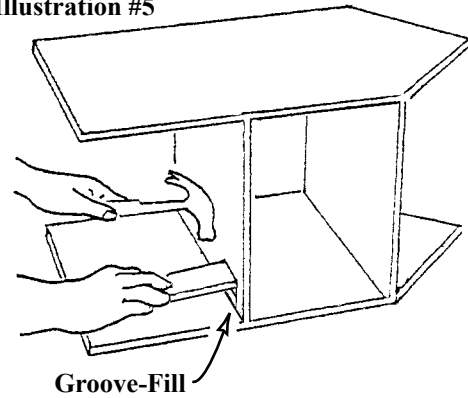
Illustration #4B

Mid Floor

Flush in back

6. Install the Groove Fill. Tap with a hammer and wood block for a snug fit. Its purpose is to fill the groove along the stair hole leaving a smooth wall (Illustration #5).

Illustration #5



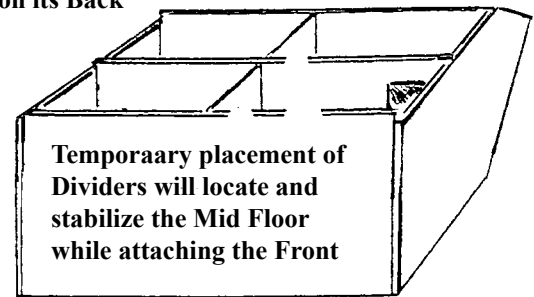
7. Spread the sides slightly; glue and tape the Base Floor into the Base Floor Groove. Make extra-sure that the Base Floor is pressed to the top-edge of the groove.

8. Attach the Front to the housebody. Lay the housebody on its BACK on a flat surface (Illustration #6).

Note: Temporary placement of Dividers will locate and stabilize the middle floor while attaching the Front panel.

9. Spread glue in the grooves of the Front panel and on the front edges of the Side panels. Set the Front panel into position on the housebody flush at the sides and bottom edges. Carefully tape in many places along the bottom edge making sure the Base Floor is tight to the top edge of the groove.

Illustration #6
Lay the Housebody on its Back



Line up one side edge flush all the way from the bottom to the top (This is the operation that straightens the house). Tape the Front securely to the Sides and Top Floor, and add weight over the Middle Floor to hold everything tight as the glue dries (Illustration #7).

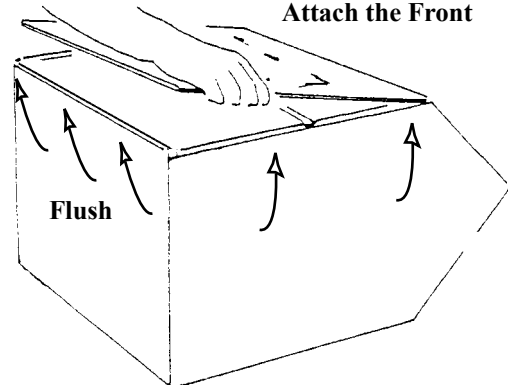
Review: Make sure all parts are in place and all the joints are tight.

- Check the position of the stair hole, closer to the front edge.
- The Base Floor is tight to the groove-top.
- The house is straight.

Finish painting the walls now

Painting: You may have already first-coated the walls. Sand between coats with 320 grit sandpaper *one clapboard course at-a-time* (this is important), then re-paint. Fold the sandpaper and sand each clapboard with your fingertips. After a few courses, re-fold to get a flat and fresh sanding surface. see www.realgoodtoys.help

Illustration #7
Attach the Front

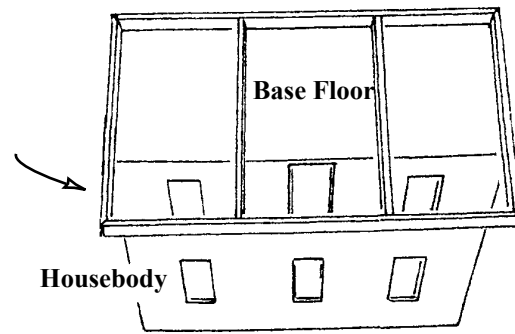


If you do not attach the Front now for whatever reason, at least tape the Front in place to square-up the house. Line up the Front at the corners of the Base Floor, then move the top of the Sides as necessary to make the fit perfect the whole way from the base corners to the top corners. Do this now so the house is square while the glue dries.

10. Pro Tip: Our Assembly Pro paints the foundation before attaching it to the house. Mix "Stucco Grit" with your foundation paint and apply with short swirls or slap the surface with the brush for a random pattern.

11 Wiring? It is easiest to run the tapewire into the cellar before attaching the Foundation to the house. Visit www.realgoodtoys.help for wiring information specific to this house

12. Glue, tape, and weight the foundation set to the housebody's Base Floor; spaced evenly at the sides and flush at the back.
The Foundation extends past the Housebody in front (Illustration #10).



1"

1"

1"

Optional - When you glue the Roofs in place, do not glue the Rear Roof set. Delay this until wiring and attic finishing is done (wallpapering, etc)

Housebody Roof:

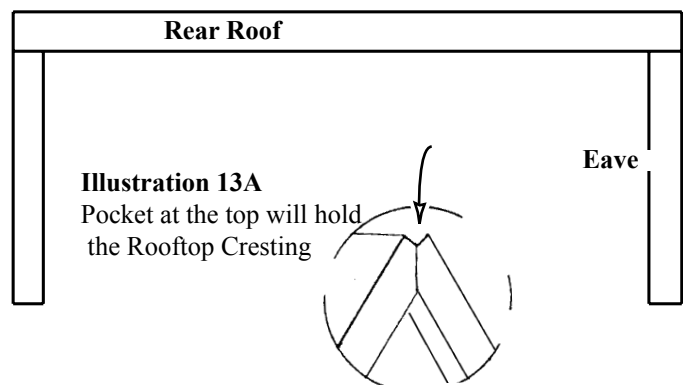
Preview: In this section you will draw Shingle guidelines, and attach the Front and Rear Roofs, and the Eaves.

13. Without glue, hold the Front and Rear Roofs on the house to see how the bevels touch at the top. The blunt edges at the top form a gluing surface for the Cresting (Roof-Top Gingerbread).

14. [Done in "Pre-Assembly"] Glue and tape together the Rear Roof and Eaves, lined up on the outside, and square with each other.

15. On the outside of the Front Roof Panel draw guidelines for locating Shingles. The first guideline should be drawn 1/4" (for a "Starter Course") or 1/2" (for "Flashing" ... see page 19) from the bottom edge. Draw the rest of the guidelines spaced 1" apart See Illustration #11 and the Guideline Measure (life size spacing) along the edge of this page. Repeat drawing shingle guidelines on the Rear Roof Set.

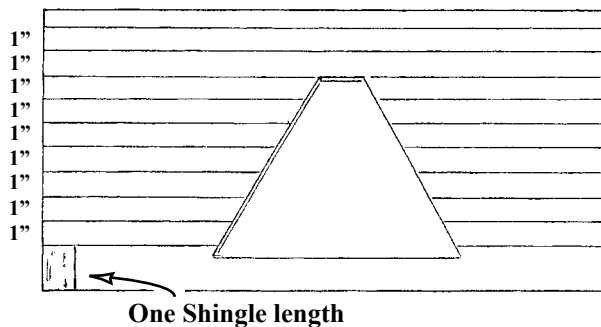
16. Prepare several flaps of tape along the top outside edge on the Front Roof. Lay the Front Roof face down on a flat work surface (Illustration #12).



1"

1"

**Illustration #11
Shingle Guidelines**

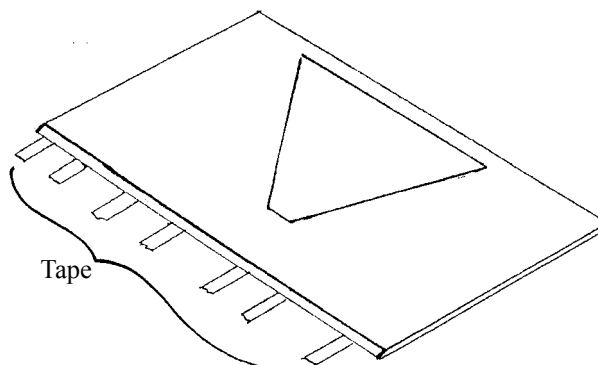


1"

1"

1"

**Illustration #12
The Front Roof is face down**



1"

1"

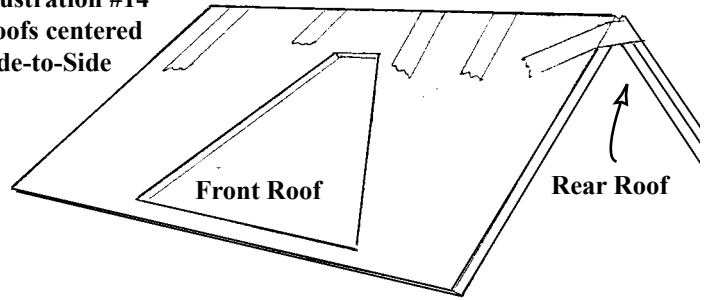
Pro tip: trace the Housebody Sides on the underside of the Roofs, and paint the Roofs' underside leaving a little unpainted between the tracings (for glue - glue doesn't stick to paint). Do this before attaching the roofs to the house.

1/4 or 1/2

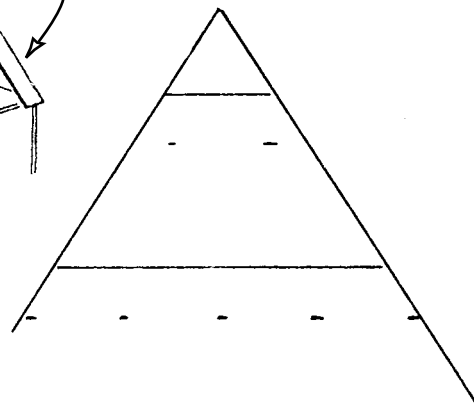
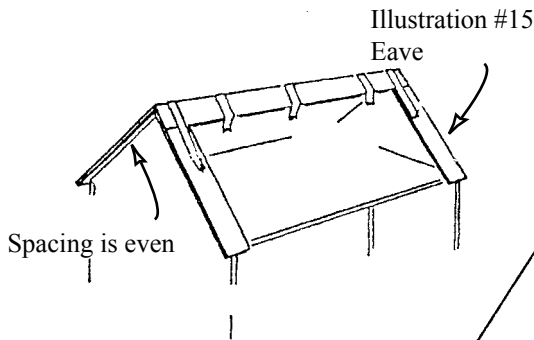
□ 17. Without glue, test the Roof set in place on the sides of the housebody, make sure the roofs are centered side-to-side (Illustration #14).

Take the Roof set off, then glue and tape the Roof set in place centered side-to-side.

Illustration #14
Roofs centered
Side-to-Side



□ 18. Glue and tape the Eaves in place, on the remaining exposed top edge of the sides, flush at the outside edge of the Rear Roof. Look under the Eaves to check that the spacing is even (Illustrations #15).



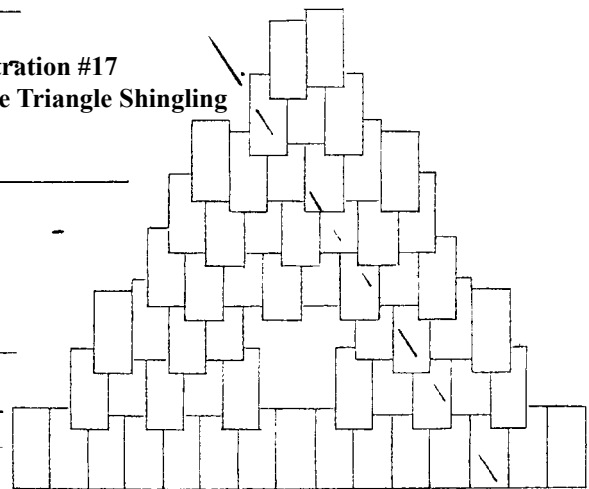
**Special Feature:
Milled Triangle does not
need to be Shingled**

Preview: In this section you will draw shingle guidelines (optional), shingle the Gable Triangle; and install the Gable set.

□ 19. Draw Shingle guidelines on the outside of the Gable Triangle. The first guideline should be drawn one Shingle length from the bottom edge. Draw the rest of the guidelines spaced 7/8" apart (Illustration #16).

To create the "Cottage Weave" shown, our pro draws a 2nd line 1/4" below the 7/8" spaced lines, and butts every-other shingle to this lower line

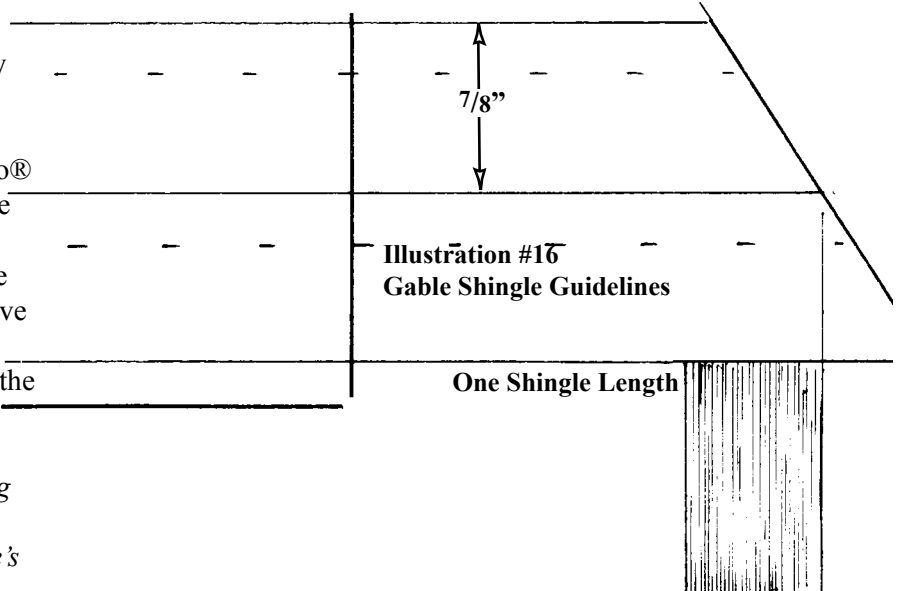
Illustration #17
Gable Triangle Shingling



□ 20. Shingle the Gable Triangle (Illustration #17). Follow the Shingling instructions in the "Shingle the Roof" section. Let the glue dry overnight..

Trim the Shingles to match the edges of the Triangle. Cut from the inside laying your x-acto® knife or single edge razor against the edge of the Triangle, and make several light cuts **starting at the bottom and working to the top**. Cut the Shingles again, this time from the outside to leave 1/8" on the edge un-shingled (this fits into the Gable Roofs' grooves). Cut from the bottom to the top - gentle and careful!

Illustration #16
Gable Shingle Guidelines



You can skip ahead to the section for assembling the Windows and Door (even the Porch section) and come back to here when the Gable Triangle's Shingles are dry.

Draw Shingle guidelines on the outside of the Left and Right Gable Roof panels. Draw each of the guidelines spaced 1" apart beginning at the bottom edge.

21. **Assemble the Gable Roof Set:**


On a flat work surface, lay out the Gable Left and Right Roofs with the bevels face down, and the points touching across the top edge.

Tape the roofs together at the top edge (Illustration #18).

Turn the roof set over and spread glue in the "V" formed by the bevels. Fold the roofs together; tape them on the ends (Illustration #19).

22. **Attach the Gable Triangle:** Glue and tape the Gable Triangle into the grooves of the Gable Roof set (Illustrations #20 & 21). Let the glue dry.

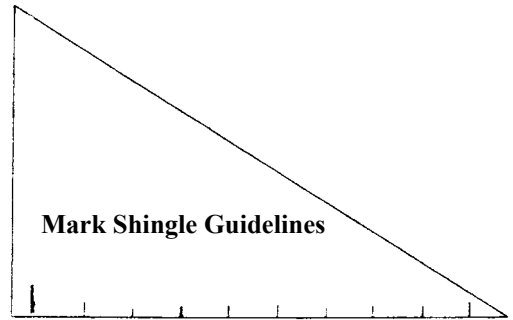
23. Adjust the fit of the Gable Triangle until the roof overhang is even in front. Mark the Gable Triangle position on the roofs.

 Remove the Gable Triangle, then replace this time glue and tape the Gable Roof set to the Gable Triangle. Check to be sure the match across the edges is still exactly matched (Illustration #21). Let the glue dry.

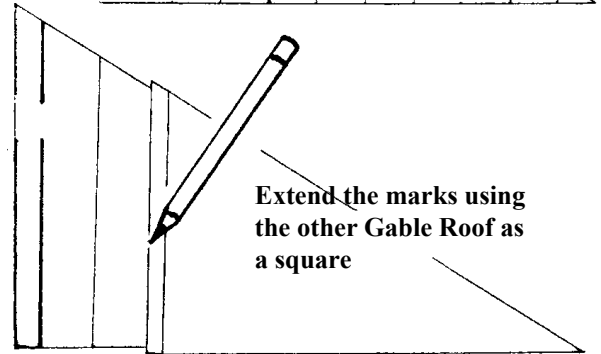
24. Glue and tape the Gable in place on the House Roof. Stretch tape from the inside of the Gable to the inside of the House Roof for a tight fit. Check to be sure the Gable is straight as the glue dries (Illustration #22).

Touch up Paint:

25. Finish painting the housebody.



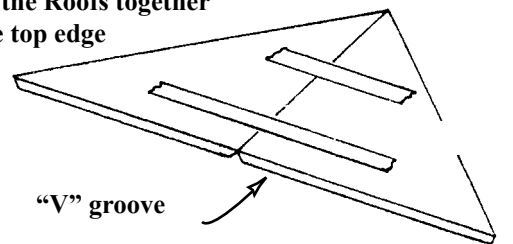
1"



1"

1"

Illustration #18
Tape the Roofs together at the top edge

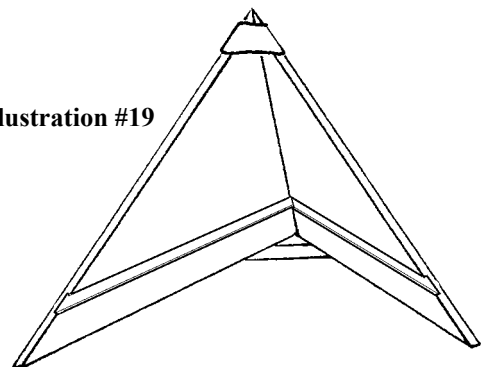


1"

1"

1"

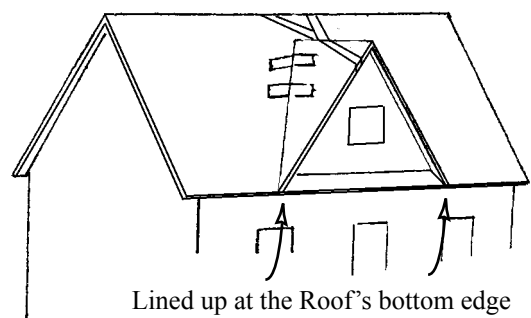
Illustration #19



1"

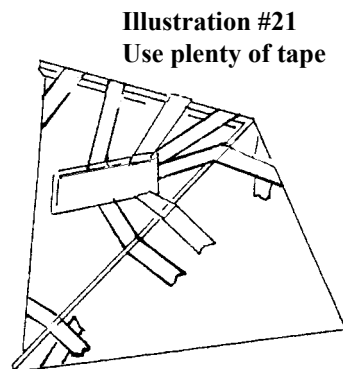
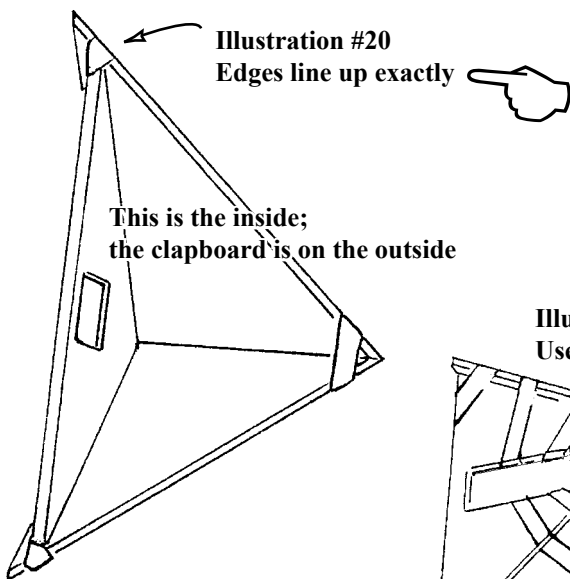
1"

Illustration #22
Attach the Gable



1"

1"



Window Assembly:

Assemble the window frames before painting

26. Test assemble (**no glue**) a window set Practice holding the frame pieces face-down on the work surface and putting on the rubber band (Illustration #23: a scrap of tape at each corner helps). In the illustrations, the hands are holding the frame parts down, not squeezing them together. When you can get the rubber band on every time without pieces flying, then you are ready for glue.

27. Glue and rubber band together ten (10) window frames. Make sure the assembly is square as the glue dries (Illustration #24).

Gable Window: Glue and rubber band together two sets (2) of four 2¹³/₁₆" Window Frames.

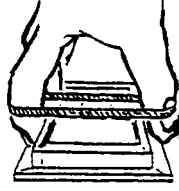
28. Check the fit of the windows in the openings. Make sure the windows can sit level with the house. Trim the corners of the openings square if necessary for a good fit.

29. Paint the Shutter parts on both faces. Without glue, adjust the spacing of the Shutter Panels on the Shutter Cores (Illustration #25). Remove the Shutter Panel, put a scant line of glue on each edge of the back surface, then replace the Shutter Panel. Too much glue will make the panel curl.

30. The Door: Pull the pin from the bottom of the Door and tip out the door panel for painting (tape the pins to the bottom of the threshold so they won't be lost) Check the fit of the Door in the opening. Trim the corners of the opening square if necessary for a good fit.

Glue the windows, the Door, and the Shuttters in place only after everything (including the House-body) is painted.

Illustration #23
The hands are holding the frame parts Down, not squeezing them together



A snip of tape in the corners helps keep the parts still while you put on the rubber band, but take off the tape while the glue dries.

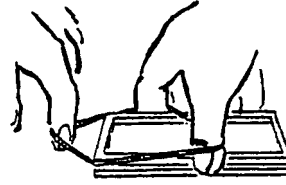
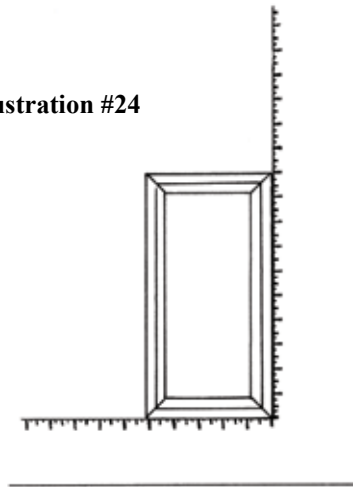


Illustration #24

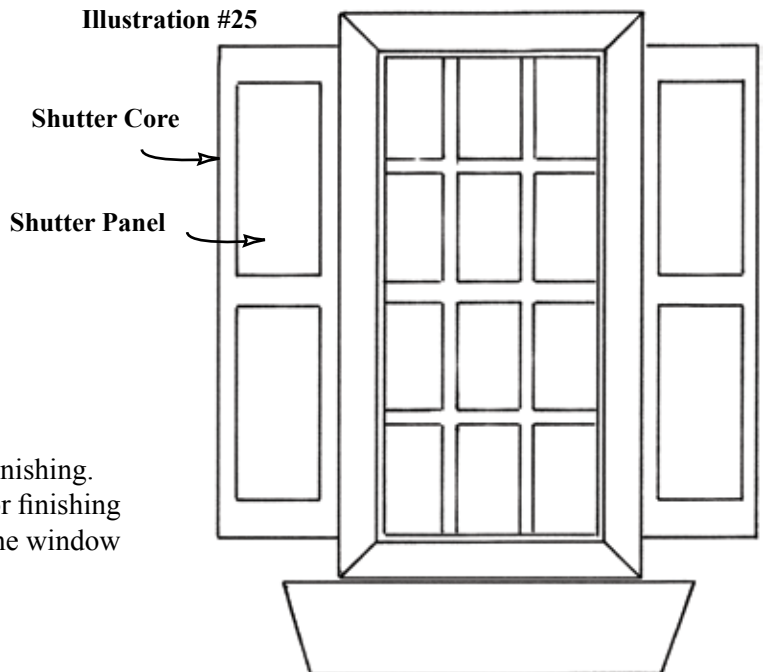


Exterior Window Frame

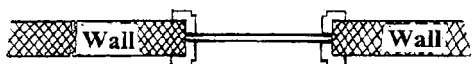


Interior Window Frame

Illustration #25



Attach the exterior window frames as part of the exterior finishing. The Panes and Interior frames are installed after the interior finishing is done (wallpaper, paint, etc.), set the window plexi into the window cutout and glue the interior window frame in place.



Porch Assembly:

Preview: In this section, you will assemble and install the Porch.

31. **Paint, sand, and second-coat the Rails;** do not paint the Rail ends at all. Set aside to dry.

32. Glue, tape, and weight the Porch Floor to the Foundation centered side-to-side, and to the Housebody's Front Panel. Let dry.

Now is a good time to draw Shingle guidelines on the Porch Roof (Illustration #26).

33. **Porch Support Triangles and Triangle Spacers:** Lay the house on its back. Against the Front of the house and without glue, organize the Porch Posts, Support Triangles, and the Triangle Spacers as shown in Illustration #27. Set the end Triangles $\frac{1}{16}$ " in from the edge of the house.

The Triangle Spacers support and locate the Triangles, and support the Porch Roof. Do not glue them so high that they will interfere with the Porch Roof. (Illustration #28)

34. Glue the Support Triangles and Spacers to the front of the house as shown. Remove the Posts.

Illustration #26
Porch Roof Shingle Guidelines

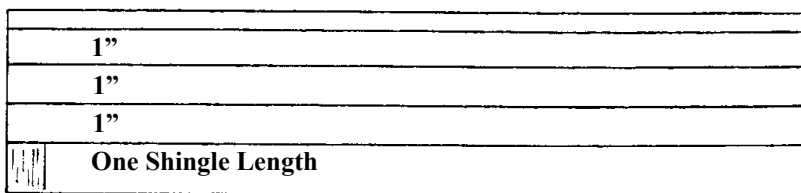


Illustration #27

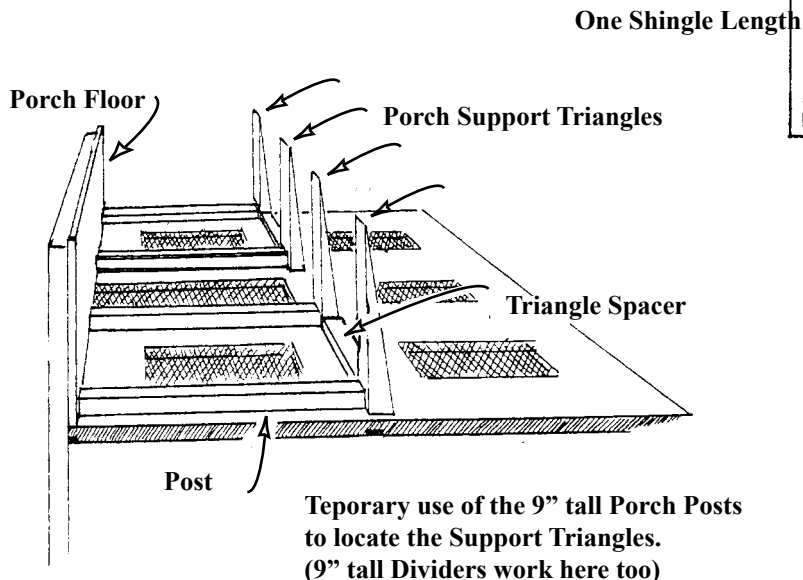
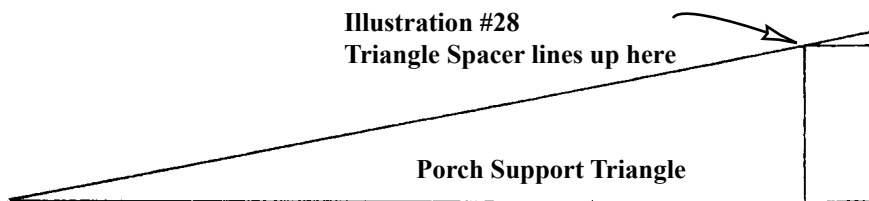
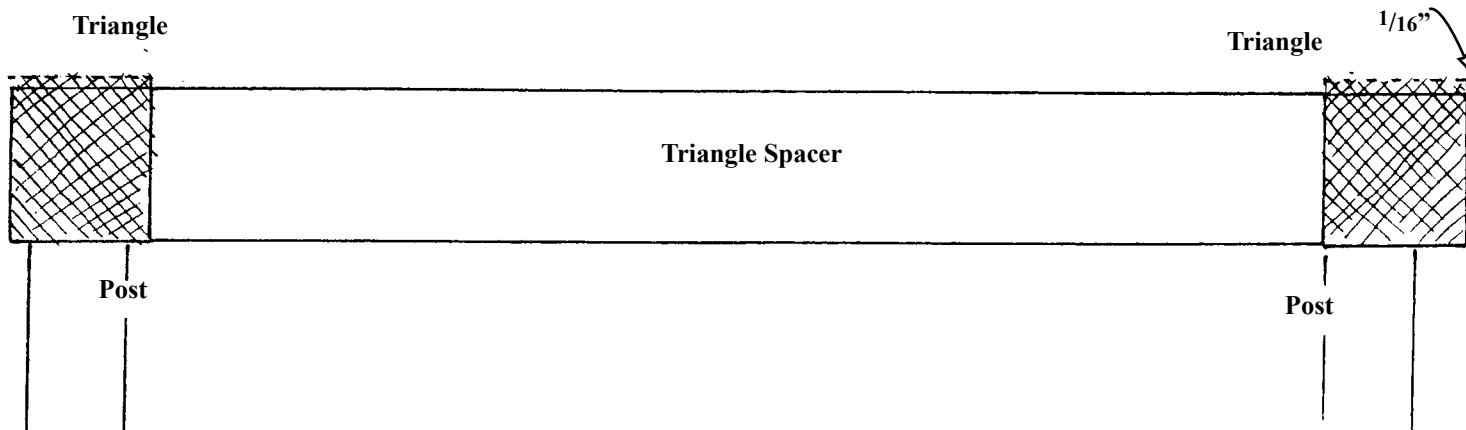


Illustration #28

Triangle Spacer lines up here

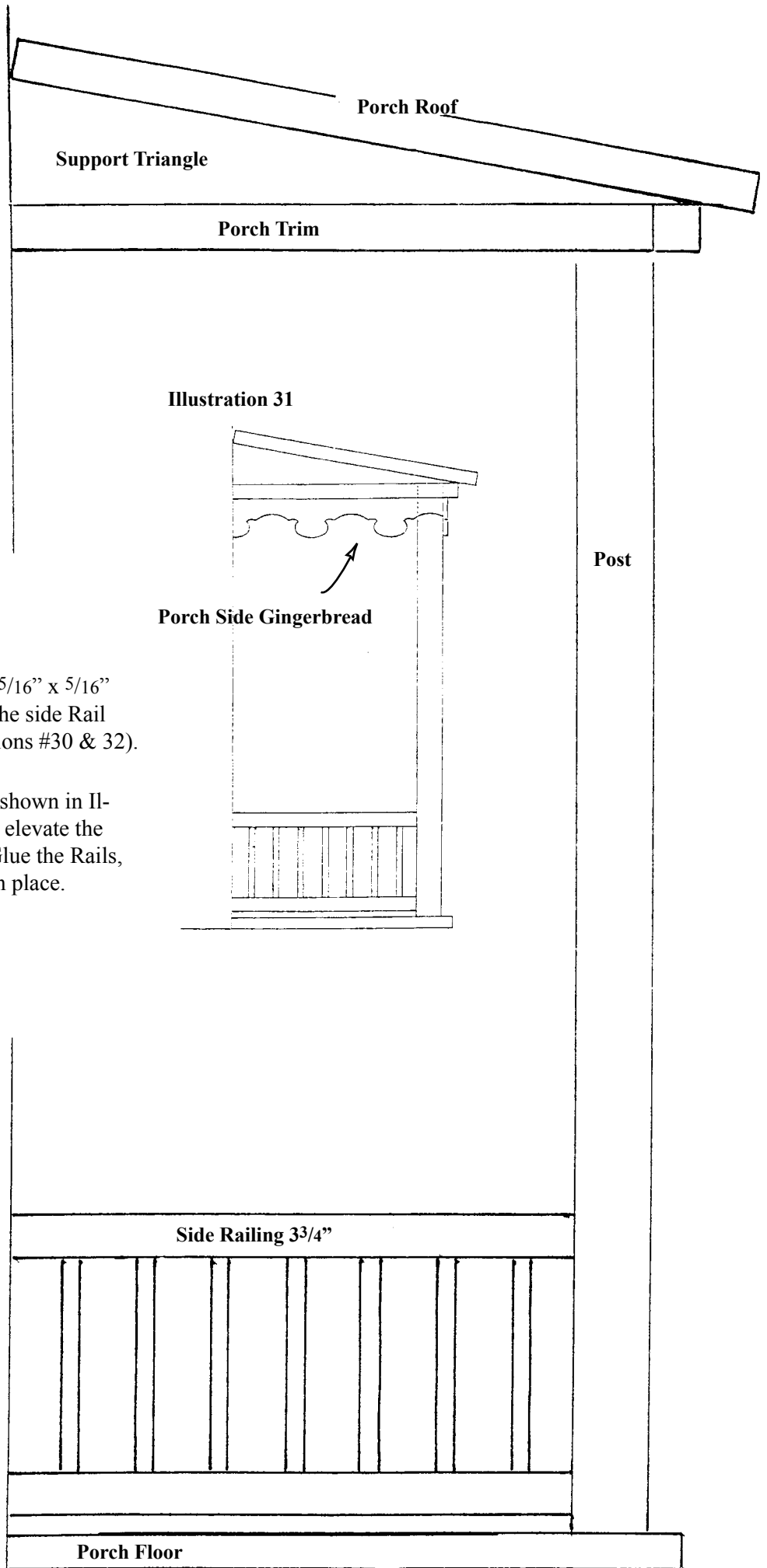


Side of House



**Special Feature
Gingerbread is Pre-Cut
and Ready to Use**

Illustration 30

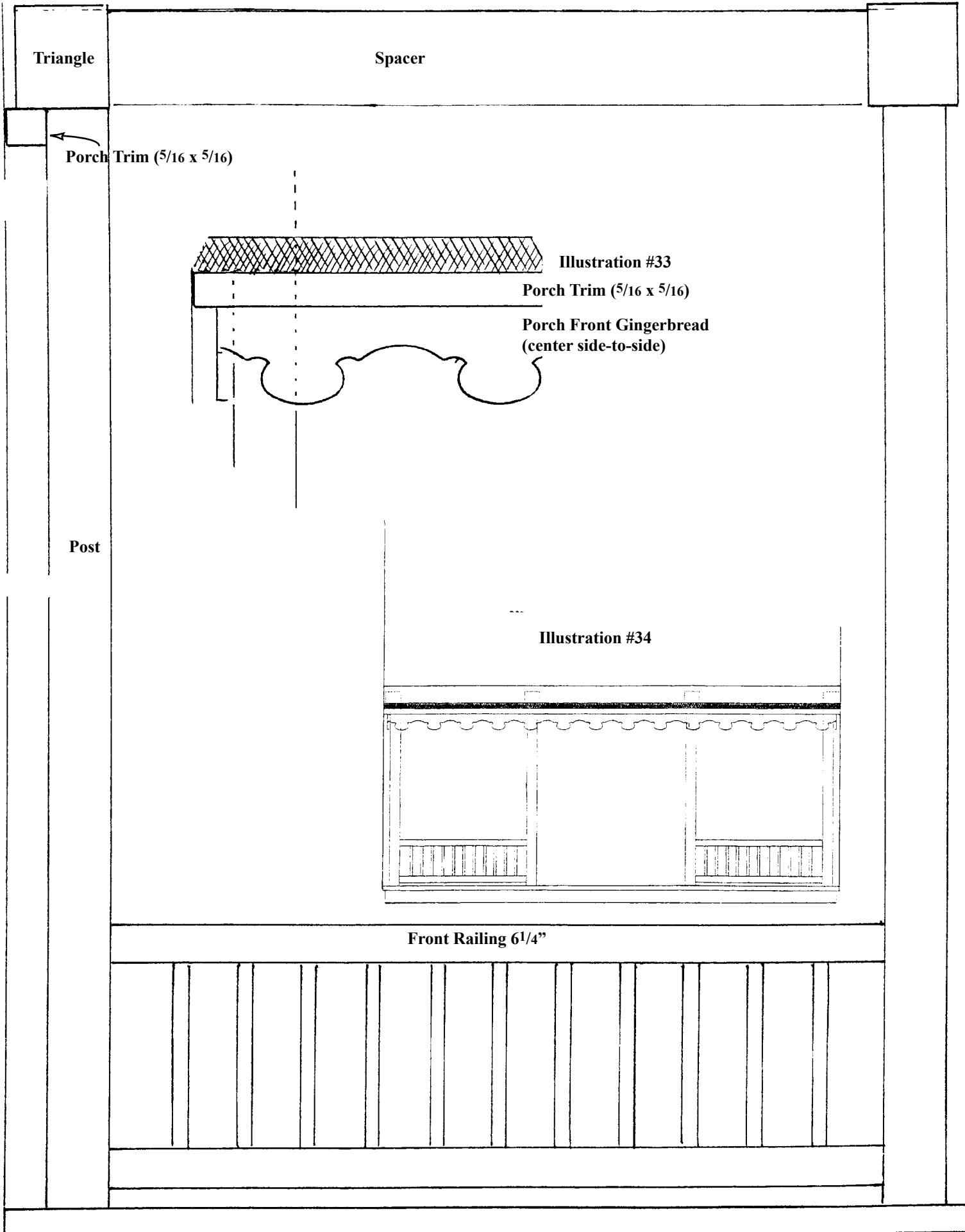


35. Cut and attach two pieces of $5/16'' \times 5/16''$ Porch Trim $4\frac{1}{4}''$ long (the length of the side Rail plus the thickness of a Post) (Illustrations #30 & 32).

36. Set up the Rails and Posts as shown in Illustrations #31 & 34. Use shingles to elevate the Railing sets above the Porch Floor. Glue the Rails, Posts, Porch Trim, and Gingerbread in place. Glue the Porch Roof in place.

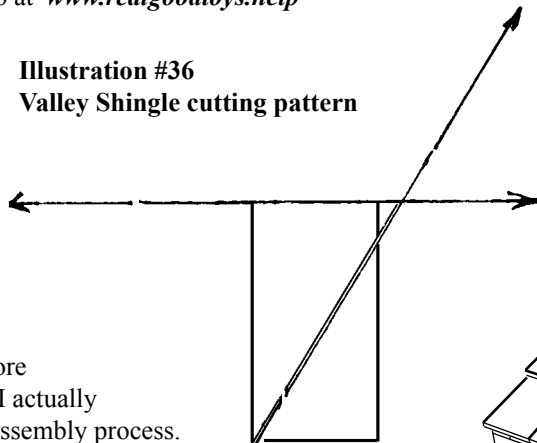


Illustration #32

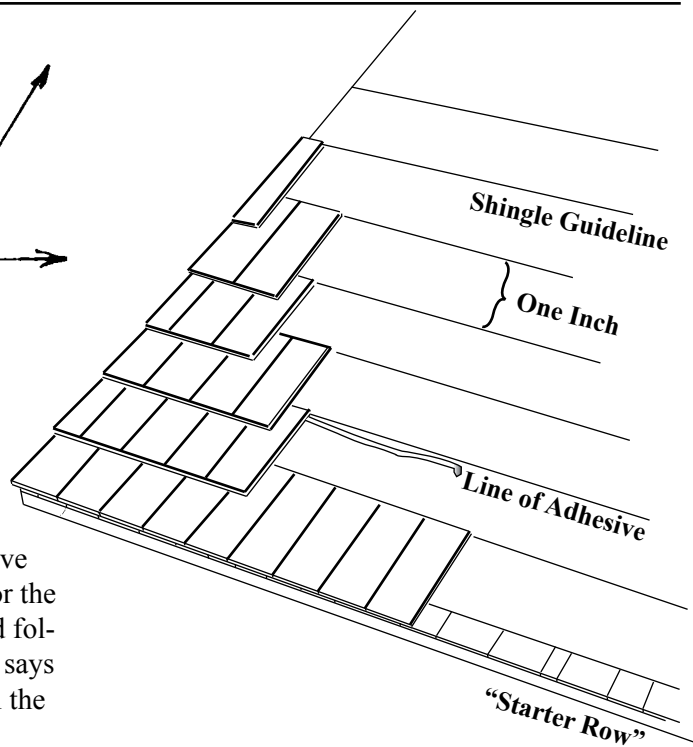


There is more Shingling info at www.realgoodtoys.help

Illustration #36
Valley Shingle cutting pattern



Pro tip: I finish the attic before attaching the Rear Roof, so I actually do the shingling last in the assembly process.



Shingle the Roof: Glue: Use a thick, *solvent-based* panel adhesive available in caulking gun tubes at building supply stores. Look for the “Flammable” warning to know it is a Solvent Based adhesive, and follow the manufacturer’s warnings. If there are no warnings or if it says “water clean up”, then it is an acrylic based adhesive and will curl the shingles.

Cut 40 Shingles that, when they are in pairs with the angles in the valley (illustration #38), the straight edge is straight up-and-down the roof (use Illustration #36 to get the angle).

A. Glue a “starter row” of 1/4” long Shingles square edge down along the bottom edge of the Roof, or “Flash” the edge with a 1/2” strip of copper (#SC from *Real Good Toys*) to prepare the bottom edge of the Roof for the first row of shingles



C. Apply a thin line of adhesive just below the lowest guideline all the way across one roof. Press the top edge of a Shingle into the line of glue, smearing the excess upward. Hold the first Shingle steady and press another Shingle into the adhesive, tight to the first. Hold the next Shingle and press in another... etc. all the way across the roof, cutting the last Shingle to fit



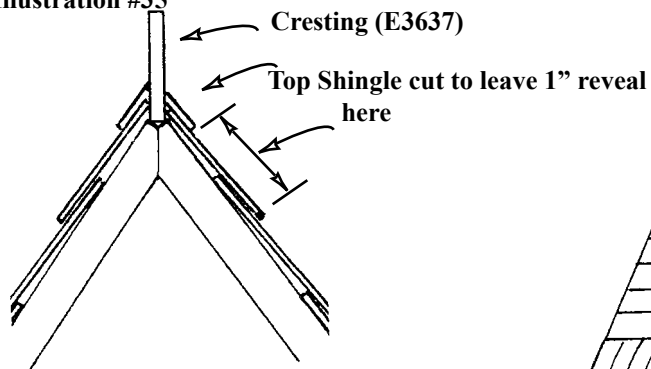
Continue up the roof one row at a time. Start the next row with a half Shingle so that the seam between Shingles weaves back and forth as you go up the roof. Line up the top edge of each row (except the starters) with the guidelines.



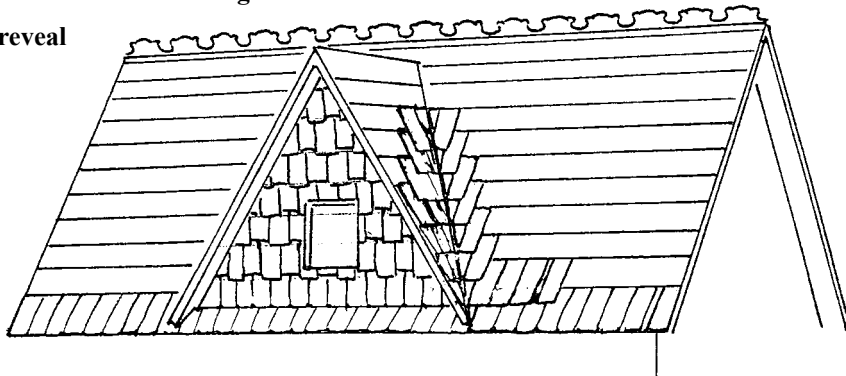
Cut the top row of Shingles so that the next lower row has a 1” reveal. Glue the last row of Shingles to the Roof and to the Cresting (Illustration #35).

40. Shingle the Back Roof and the Porch Roof.

Illustration #35



E3637
Cresting



Finish the Outside

Special Feature

Gingerbread is Pre-Cut and Ready to Use

- 41. Paint and install the Gable Gingerbread to the edge of the Gable Roofs, covering the edges of the shingles.
- 42. Paint and install the Eave Gingerbread to the edges of the Roofs, covering the edges of the shingles.
- 43. Cut one end of each piece of Stripwood to match the Stripwood angle pattern.

(Illustration #39)

Paint and attach the Stripwood to the front and back edges of the Sides (Illustration #40). Cut off the bottom edges to fit.

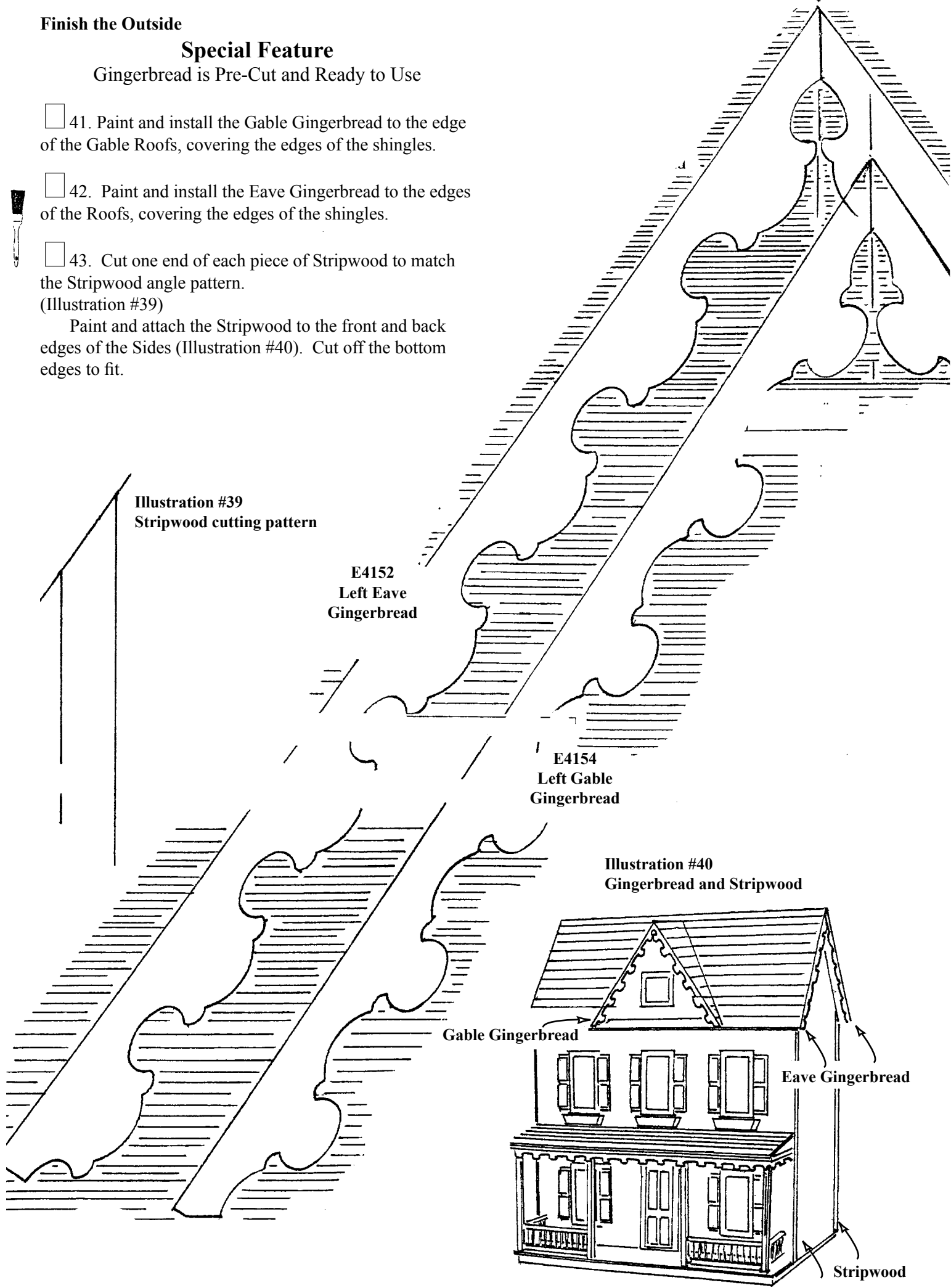


Illustration #39
Stripwood cutting pattern

E4152
Left Eave
Gingerbread

E4154
Left Gable
Gingerbread

Illustration #40
Gingerbread and Stripwood

Gable Gingerbread

Eave Gingerbread

Stripwood

Finish the Inside...Plan Ahead!

Interior finishing involves so many choices! Will this house be a play-house or a display for miniatures? What accessories will be used and where will they go? Wiring? Wallpaper? Tile or carpeting? Every choice makes a difference in the order of finishing. Real Good Toys has provided materials for some basic interior work, but you may choose to do it differently.

- Make your choices
- Get your materials
- Test your layout

With the pieces in your hands, imagine the steps to get to where you want to be.

Now you're ready for **your** order of interior finishing. Here's the order that our assembly pro follows for tackling most custom interior finishing:

- Dividers
- Electrical wiring (using "tape" style wiring)
- Wallpaper
- Interior Window Trim
- Flooring
- Stairs
- Baseboard and crown moldings

44. Dividers and Attic Partitions are important for floor support, but they can go wherever you like. Try different layouts and test your furnishings before permanently installing the Dividers

45. Lay the window panes in the window cutouts.
Glue the interior window frames in place
Glue the Door Interior Trim to the inside of the Door

45. Line up the Stringer with the pattern, and mark the cut. Cut the Stringer with a fine toothed saw.

46. Glue the Bottom and Top Stair Blocks together (Illustration #41). Without glue, test the Stair assembly in the stair hole. The stairs are tight to the wall and the top tread is flush with the floor.

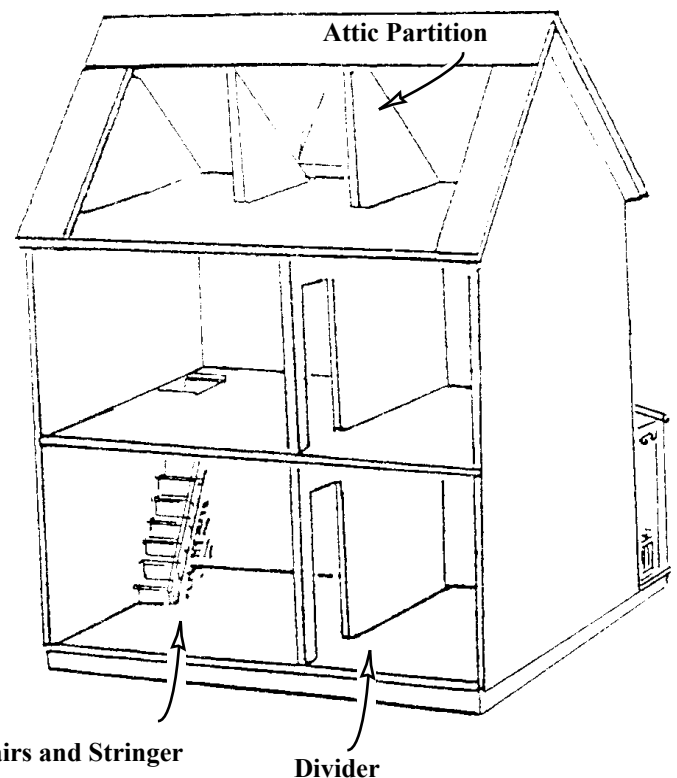
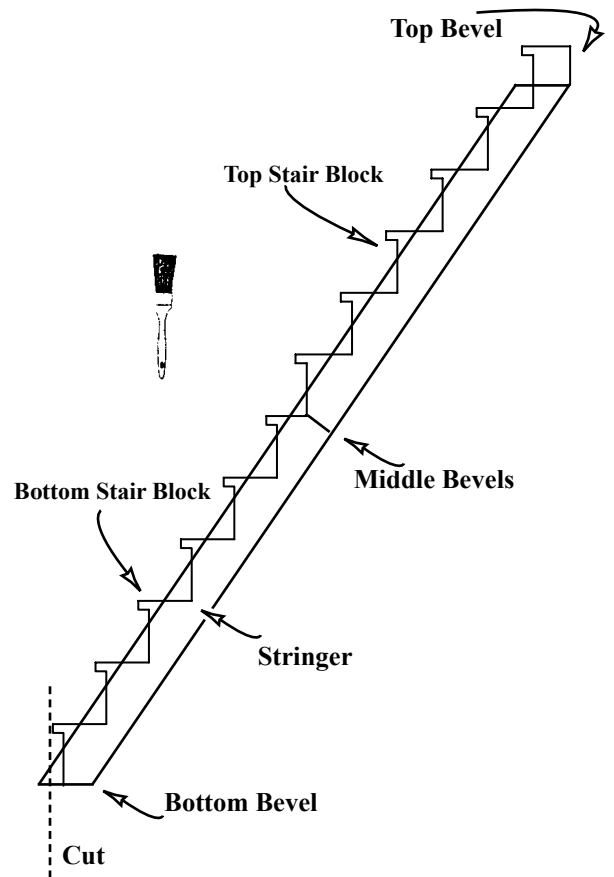
Wait to permanently install the stairs until flooring and wallpapering are done.

Glue the stair assembly in place. Let dry.
Glue the Stringer to the side of the Stair assembly for support.

Adjust the fit of all the parts. Everything must be straight as the glue dries.

You have finished the Dollhouse assembly part of your project...

ENJOY THE REST



Stairs and Stringer

Divider

Options:

A wide variety of materials and accessories are available to help you achieve your dream house.

The following is a partial list of accessories and options that fit this dollhouse, available through your dealer from *Real Good Toys*.

See www.RealGoodToys.com for detailed info.

J-FK Interior finishing materials: Baseboard and crown moldings & stairway banisters and landing rails.

JM44 Colonial Style Junior Addition (see the photo on pg. 15)

JM66 Junior Conservatory Addition (see the photo below)

SC Copper flashing for valleys and hard to finish areas.

Dye1 Brown Shingle dye (reddish-brown)

Dye3 Grey Shingle dye (blue-grey)

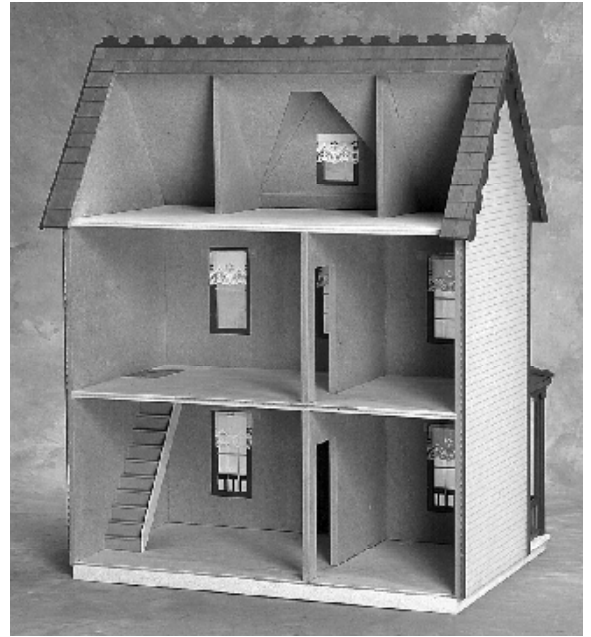
5025 Louvered Shutters (pair)

6007 6 Panel interior door

Stucco A paint additive for foundations or stucco walls.

T10 12" diameter Turntable (holds 1000 lb.)

6888 the "Best1" wiring set with easy to follow instructions, links to web support, necessary tools, and supplies - everything you need for the basic wiring of this house.



Slideshows, demos, useful links, details, wiring help, and photos are all at:
www.realgoodtoys.help



SE-JM401 shown here with
JM66 Conservatory Addition (right)
&
JM44 Colonial Style Addition (left)
(each sold separately)



SE-JM401 shown here with
(2) JM44 Colonial Style Additions
(each sold separately)