

Parts:

1	E8121	Bay Base Floor	1/4	7 1/4	22 1/32	angles
4	E8116	Bay Side Wall	3/8 Milled	23/32	13/4	
2	E8117	Bay Front Wall	3/8 Milled	23/32	3 1/2	
6	E8138	Bay Vertical	3/8	3/4 bev	97/32	
2	E8134	Bay Side Foundation	3/8	3 1/4	13/4	bev
1	E8135	Bay Front Foundation	3/8	45/8	13/4	bev
1	E8137	Bay Top	3/4	10 13/16	3 15/16	angles, molded
6	E8155	Window Frame	5 1/4 miter	45 Deg	^ 45 Deg	
2	E8160	Window Frame	3 3/4 miter	45 Deg	^ 45 Deg	
4	E8164	Window Frame	1 15/16 miter	45 Deg	^ 45 Deg	
1	E8159	Middle Frame	47/16			
1	E8161	Trim	1/16 x 3/8	49/16		
4	E8163	Narrow Pane	printed	15/16	45/8	
2	E8165	Spacer		13/16		
2	J0642	Interior Window Trim	3/32 x 3/8	3 23/32, angled	^	
4	J0643	Interior Window Trim	3/32 x 3/8	2, angled	^	
6	J0645	Interior Window Trim	3/32 x 3/8	5 11/32, angled	^	
2	J0637	3/4 Trim	3/4 x 3/32	8 15/32		
2	J0638	3/8 Trim	3/8 x 3/32	8 15/32		
8	J0639	3/16 Trim	3/16 x 3/32	8 15/32		

www.realgoodtoys.help has painting and sanding videos

Paint (first coat) all the parts. Do not paint edges that will be glued. Apply just enough paint to fill the grain and leave a hint on the surface.

Sand until the wood is smooth, the paint is transparent, and lots of the wood is showing thru. Sand clapboard one-board-at-a-time.

Second-coat after assembly but before trim.

This Bay and these parts are as used on the JM1065. Your use may be different and the way these parts will fit best on your house may be different too.

Test these bay parts on your house and adjust as needed.

This is the JM1065 Gable where the JM22 Bay fits:

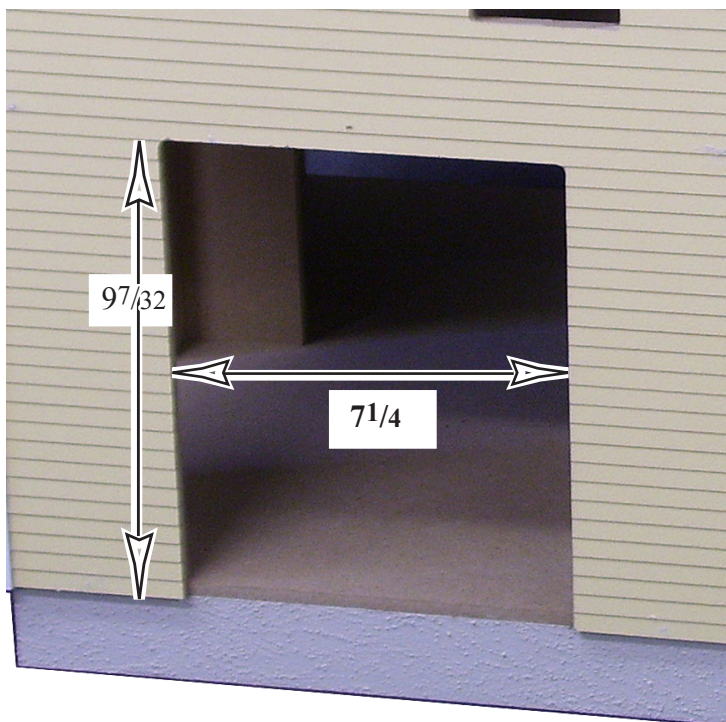
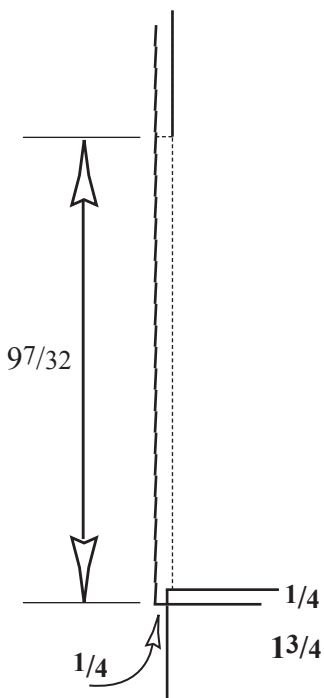

Pre-Assemble the Bay Wall sets; each set is 2) Bay Verticals and 2) Bay Walls (1³/₄ or 3¹/₂" long) The clapboard profile is on the outside. The wider face of the Bay Vertical is on the outside.

view from the top

Make two Bay Side wall sets

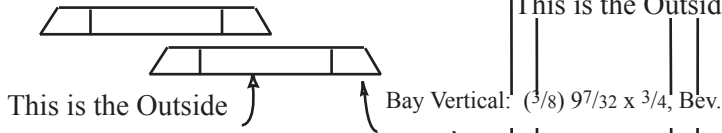

Make one Bay Front wall set

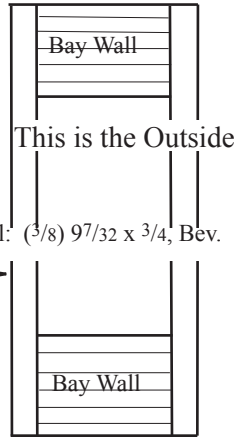

Like this!

The wider face is the outside

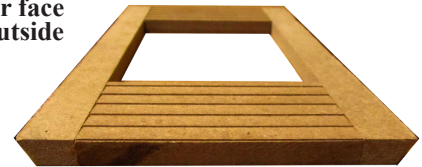
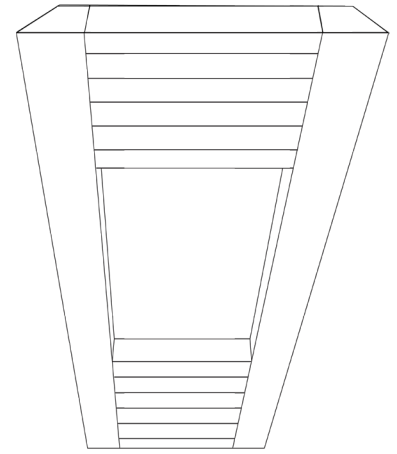

III. Assemble the Bay:

Continue to Step 4 without stopping

1. Glue and tape the Bay Base Floor to the front edge of the house's Base Floor, inside the bay cutout (7¹/₄ W x 97/32 T) (Illustration #1). Make sure the floor surface across the joint is tight and smooth.

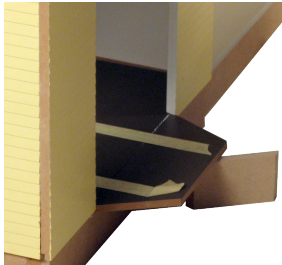
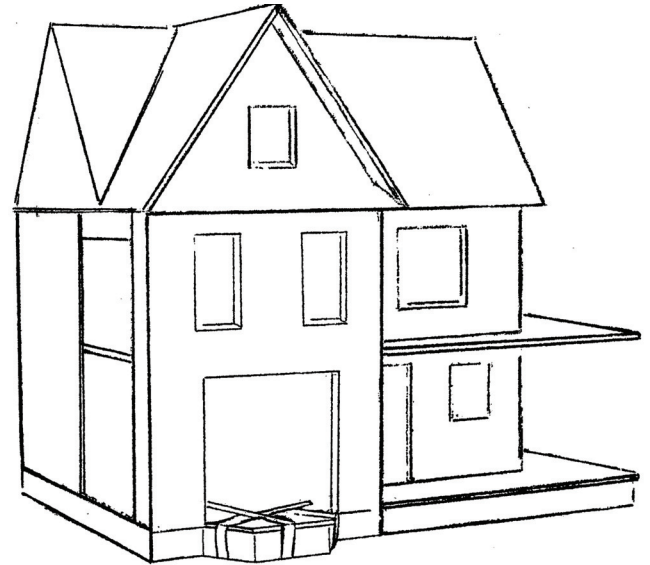

Illustration #1

Glue and Tape the Bay Base Floor to the Front Edge of the House's Base Floor



2. Glue and tape together the Bay Foundation (Illustration #2).

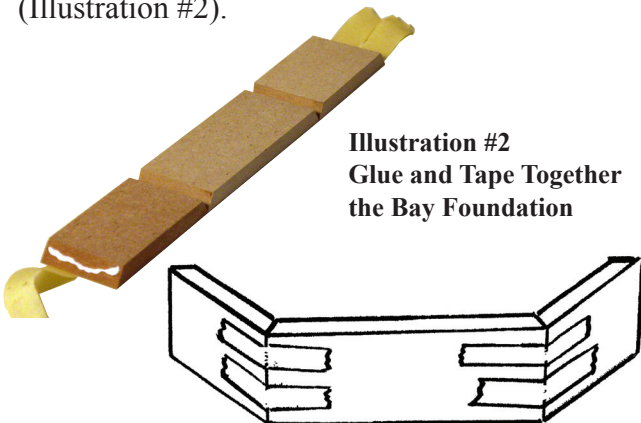
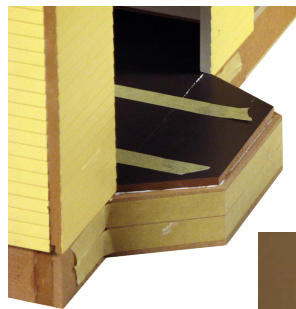
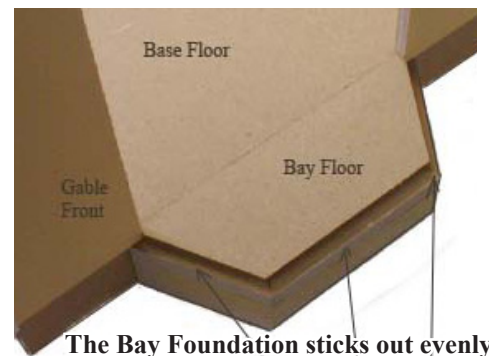

Illustration #2
Glue and Tape Together the Bay Foundation



3. Glue and tape the Bay Foundation set to the Bay Base Floor and to the House Foundation. The foundation extends past the Bay Base evenly on all edges (this is a ledge to hold the bottom of the Bay Walls).



The Bay Foundation sticks out evenly

4. Tape the Bay wall sets together at the corners (Illustration #4). Test them on the house wrapped around the Bay Floor (but leaving a small clearance between the walls and the floor); adjust if necessary.

Glue the Bay walls together, to the Bay Base Floor, and to the foundation (Illustration #5).

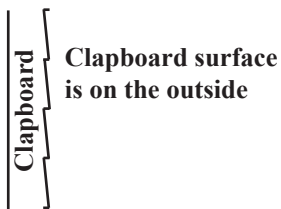
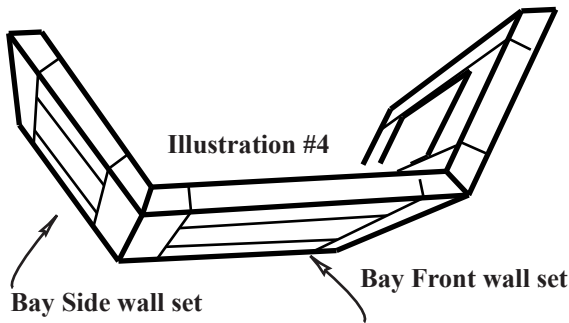
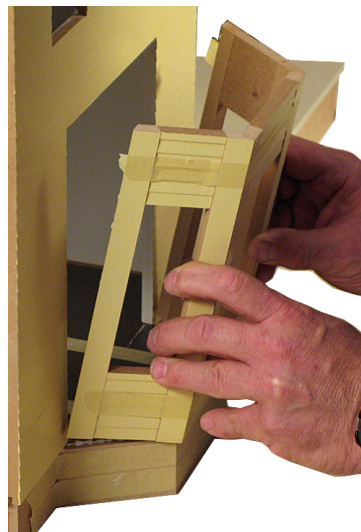
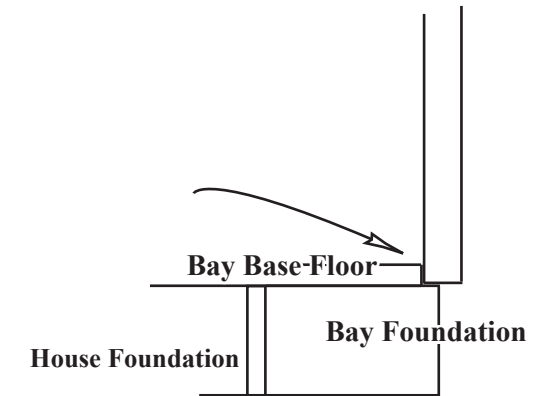
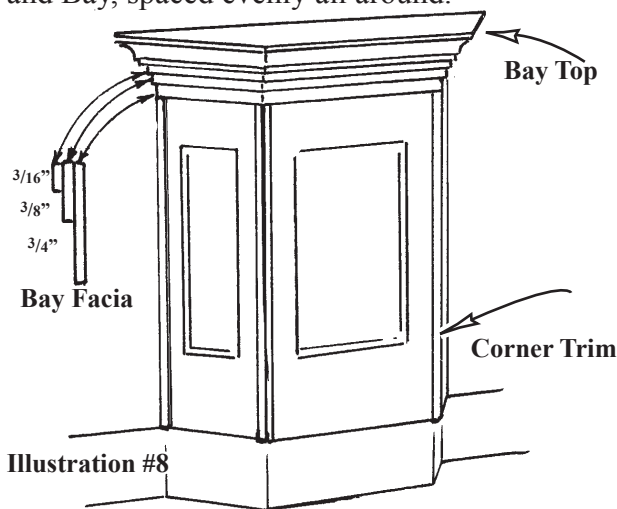

Illustration #5
Glue the Bay Walls Together,
to the Bay Base Floor,
and to the Foundation



5. Glue and tape the Bay Top to the housebody and Bay, spaced evenly all around.



6. Cut, paint, and install the Front Bay Facia from $3/4''$, $3/8''$ and $3/16''$ Trim (Illustration #8).

7. Cut, paint, and install the Corner Trim from $3/16''$ Trim ($3/16 \times 3/32$) $8^{15}/32$.

A Trim Cutting photo gallery is at www.realgoodtoys.help

Use this Bevel Guide when Cutting the Ends of the Bay Facia

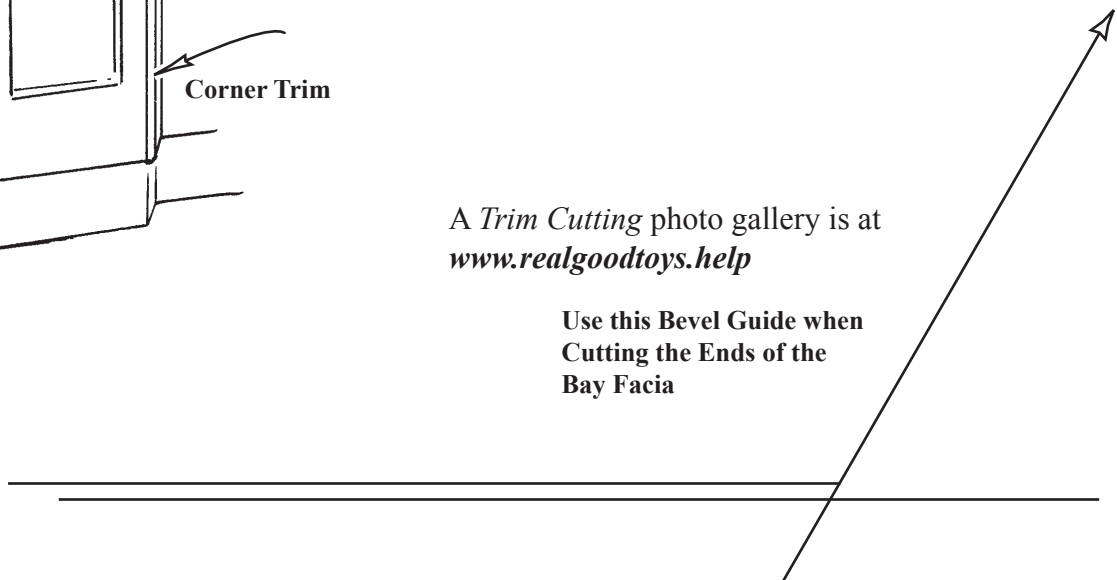

V. Window Assembly:

The parts used in this section should be painted ahead of time. If they have not been painted, do so now.

www.realgoodtoys.help has more window assembly photos

1. **Single Narrow Windows:** Test assemble (*no glue*) the window set.

Practice holding the frame pieces face-down on the work surface and putting on the rubber band. When you can do it every time without pieces flying, then you are ready for glue (Illustration #1).

2. Glue and rubber band together the window frame with the Window Pane in place. Make sure the assembly is square as the glue dries (Illustration #2).

3. **Double Narrow Window:** Lay out and assemble the Double Window face down on the work surface (Illustration #3).

4. Turn the Double Window face up and push the Middle Frame down to the work surface. Adjust the spacing of the Middle Frame with the 13/16" Spacers (Illustration #4).

5. Glue the Trim to the Frames centered on the Middle Frame.

6. Touch-up the sanding and paint, but *stay away from the Window Pane!*

7. **Interior Window Trim** Assemble and paint the interior window trim sets. Glue them centered on the windows after wallpaper or paint is done.

2) Single Narrow windows, each uses:

- (2) J0643 Interior Window Trim (3/32 x 3/8) 2 angled\
- (2) J0645 Interior Window Trim (3/32 x 3/8) 5¹¹/32 angled\

1) Double Narrow window uses:

- (2) J0642 Interior Window Trim (3/32 x 3/8) 3²³/32 angled\
- (2) J0645 Interior Window Trim (3/32 x 3/8) 5¹¹/32 angled\

Illustration #1

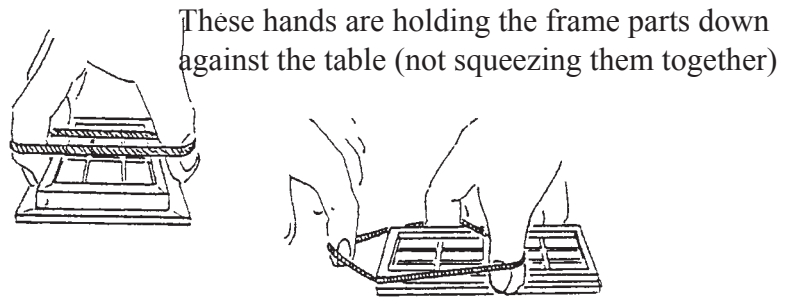

A snip of tape in the corners helps keep the parts still while you put on the rubber band, but take off the tape while the glue dries.

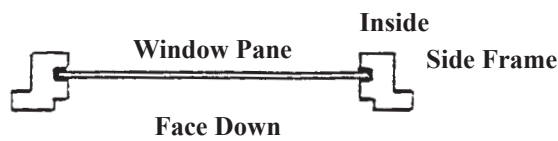

Illustration #2
Face Down:
Inside Showing

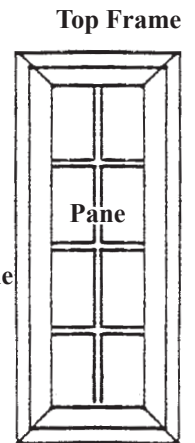

Illustration #3

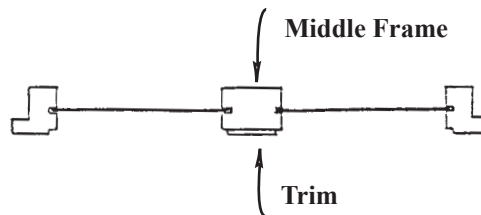

Illustration #4

