

**Packing list for:**  
**ELECTRIC THROTTLE SERVO UPGRADE KIT**  
**MCS850\_UPGRADE**

<u>Qty</u>	<u>Part Number</u>	<u>Description</u>
1	MCS 850	Electric throttle servo assembly (without nose)
1	MCS 850B	Servo cable-sealing boot
1	MCS 850C	Servo Nose
3		M4 x 12 pan head screws
1	BS116	'O' Ring
2	MCS 054	Wire ring, cable retainer (1 spare)
1	MCSSC ???	Servo cable (customer to specify length)
<b><u>OR</u></b>		
1	MCSCC 1150	Carburettor cable - 1150mm long
1	MCSU 427	Inner cable (wire rope) fitted with ball nipple and barrel nipple (spare cable)
2		Inner Cable End Cap (1 spare)
1	MCS8001-SRV	Servo wiring harness (2m or length specified by customer)
10	AMP 3-1447221-4	Computer plug terminals (6 spares)
1		Paper clip (terminal insertion & blanking plug removal tool)
5		150mm cable ties
5		200mm cable ties
5		300mm cable ties
1		Electric servo installation manual (this manual)

**Customer requested parts**

Mounting brackets (MCS 851, 852, 853 or 854 parts)

Hose Clamps (HoseClamp #)





## **Motorcycle Electronic Cruise Control**

# **Installing the new MCS850 Electric Throttle Servo instead of the old MCS574 Vacuum Actuator/Servo**

**16 February 2017**

## **MOTORCYCLE CRUISE CONTROLS**

**MotorCycle Setup Pty. Ltd.  
A.B.N. 94 798 167 654  
6 Kingston Street  
Mount Waverley, Victoria, 3149  
AUSTRALIA**

The MCS574 vacuum actuator/servo that has been used on MotorCycle Cruise Controls cruise control kits for the last 17 years is no longer available. The manufacturer stopped production of the actuator in 2014. MotorCycle Cruise Controls purchased several hundred from the last production run. They are now all sold.

In the meantime the new MCS850 Electric Throttle Servo was developed by MotorCycle Cruise Controls and now used instead on all new cruise control models.

Where possible, we source bikes that we developed on the vacuum actuator and have redeveloped a cruise control kit for them using the new electric throttle servo, but we cannot get access to the majority of those bikes. Consequently, the only way we can provide a cruise control on these older models, is for the installer to fit the new electric throttle servo instead of the vacuum actuator.

**The purpose of this document is to provide as much information as possible to allow the installer to determine if it is possible to fit the electric throttle servo and to make fitting it as easy as possible.**

**NOTE: - We recommend that you read this manual in conjunction with the cruise control installation manual for the vacuum actuator/servo cruise control for your bike to allow you to become familiar with the cruise control components and where they are fitted on your bike. This will help you to decide if and where you can fit the electric throttle servo.**

We stock a variety of mounting brackets and hose clamps to mount the new electric throttle servo. The installer must decide if any of these parts are suitable to mount the servo on the bike, and order the appropriate parts. We will provide a reasonable quantity of these parts free of charge (typically 1 or 2 brackets will be required and hose clamps to suit the mounting brackets).

The new compact electric throttle servo is about twice the weight and slightly longer than the old vacuum actuator/servo, but is almost  $\frac{1}{2}$  the diameter. The performance of the electric servo is more precise and responsive than the vacuum actuator, resulting in smoother and more precise speed control than before.

The drawing below shows the dimensions of the vacuum actuator (servo) that was supplied in our older cruise control kits, and is no longer available. You will see photos of the actuator installed on your bike in the existing installation manual. In some cases the vacuum actuator was also provided with covers to enhance appearance and provide protection from the elements.

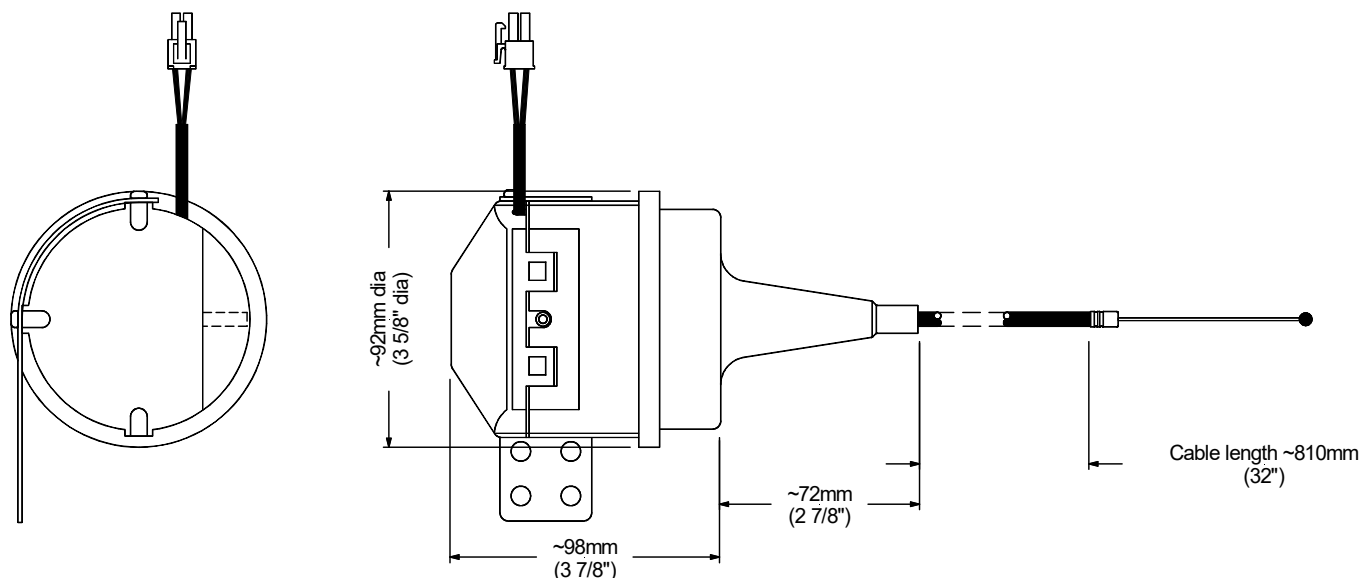

## **Components in the cruise control kit needed for the Vacuum Actuator.**

The vacuum actuator requires various components for connection to vacuum from the bike's engine to the vacuum actuator. In most cases this is simply a vacuum hose and one-way valve/s, in some cases there are additional parts such as 'T' connectors, restrictors and a vacuum reservoir.

## **None of these parts are required for the electric throttle servo and will not be supplied in the kit.**

The drawing below shows the dimensions of the electric throttle servo that is now supplied in our new cruise control kits. There are several photos of the electric servo installed on various bikes later in this document.

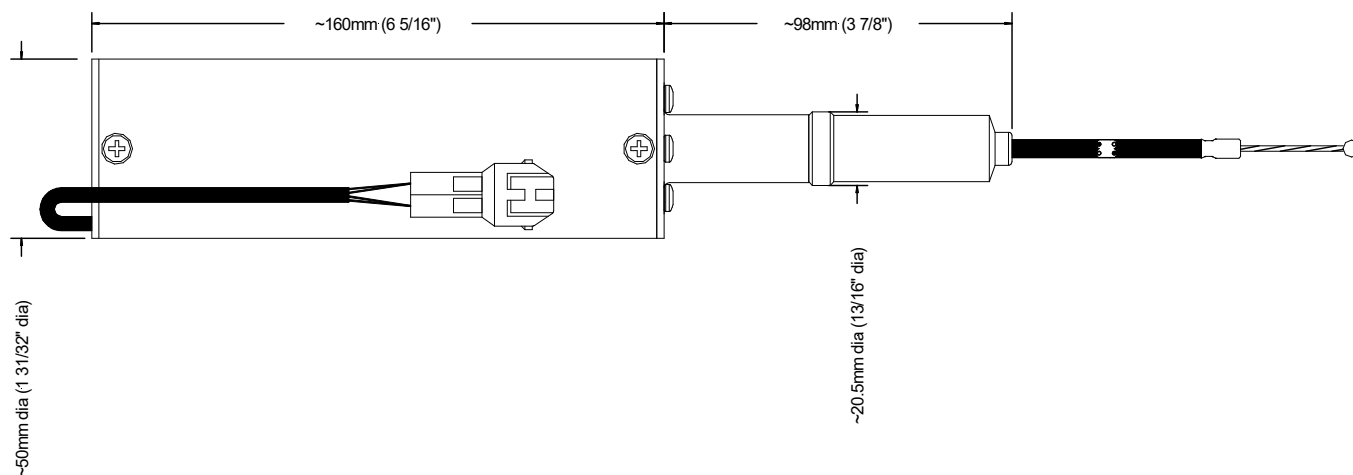

In order to fit the electric servo on a bike setup for a vacuum cruise control kit, you need to find a suitable space for the servo and a way to mount it. You need to get good cable routing from the servo to the cruise control CIU (Cable Interface Unit or cable junction box).

In some cases, it may be possible to fit the electric servo in the same location that vacuum servo was fitted.

The main things to consider are:

- The electric servo is quite a lot heavier than the vacuum servo and therefore needs a stronger, more robust mount than the vacuum actuator.
- The electric servo is quite a lot longer than the vacuum servo. The body length of the vacuum servo from the back end to the cable is ~170mm, the electric servo is ~260mm from the back to the cable.

The servo can be mounted pretty much anywhere within reach of the cable to the CIU (Cable Interface Unit), see later in the document for cable lengths available, but should be kept away from extreme heat (exhaust headers or junctions) and not mounted in direct water/dirt/road spray locations. The servo body is aluminium tube, anodised black to improve the appearance. The ends of the servo are made of black engineering plastic.

The servo can be mounted using long hose clamps to a frame tube, similar to the way the remote reservoir on some shocks are mounted, or brackets can be made to mount it. We also have a range of 'universal' mounting brackets to assist in mounting the servo. More details on these brackets are provided later in this document.

The servo weighs about 700grams or 25 ounces, more than twice the weight of the vacuum servo.

A piece of 50mm or 2" PVC pipe or a tube from a caulking gun (silicone sealant or similar) is ideal to use as a 'mock up' of the servo to see where it might fit on the bike.

Cut the length of tube to match the length of the servo. The plastic tip of the caulking tube is a fairly close match to the end of the servo in length but is smaller in diameter.

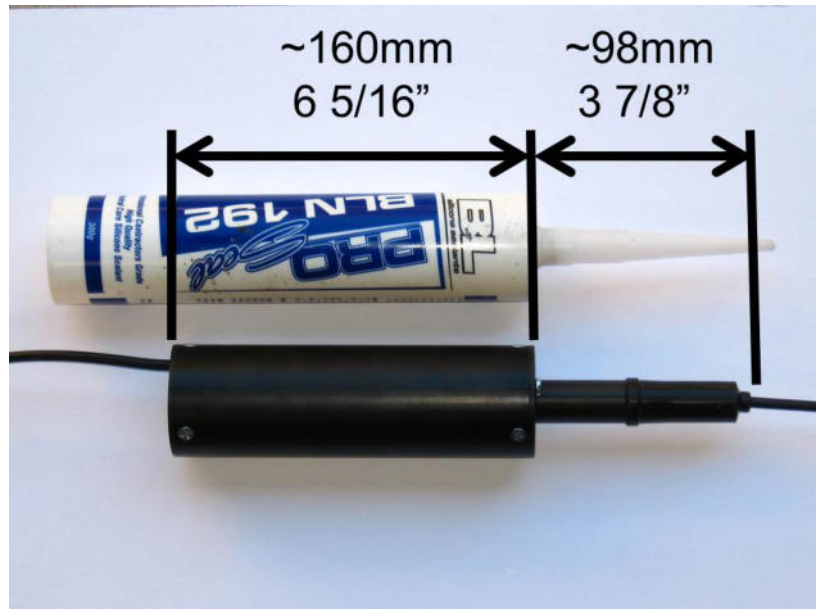

Make sure that there is space for the electrical wire out the back (left) end of the servo and in particular for a straight run for the cable out the front (right) end. The cable can be bent but the radius of the bends must not be less than 50mm (2"), and preferable much larger than that. A 180 degree turn of the cable must not be less than 100mm (4") across the bend, and should if possible be twice that.

Wiring for the electric servo and vacuum actuator is similar, but the wires are different colours and the wires are inserted into different positions on the cruise control computer plug. This difference will be covered later in this document.

### **Universal servo mounting brackets.**

The following diagrams show the current range of universal mounting brackets available for the electric throttle servo.

Most of these brackets are laser cut from 1.5mm thick 304 stainless steel, some of the longer brackets are made from 2mm thick material. All dimensions on the drawings are in mm.

### **MCS851 hose clamp & bolt mounting tabs**

The MCS851 series tabs are designed to use an existing bolt or bolt hole on the bike, and a hose clamp around the bracket and the throttle servo. Generally you will need at least two of these brackets to mount the servo, but in some cases you will get away with one bracket and cable tie/s or Velcro.

If the bolt hole in the bracket is too small, it can be drilled to make it larger. There are some comments on modifying these brackets later in this document.

**NOTE: - The Installer must order the brackets needed for the installation. If no brackets are ordered, none will be supplied in the kit.**

**WARNING: - Take care with drilling these brackets, mount the bracket in a vice, use a good sharp drill, use suitable cutting lubricant for drilling stainless steel and run the drill at moderate speeds to reduce heat generation damaging the bracket or drill bit.**

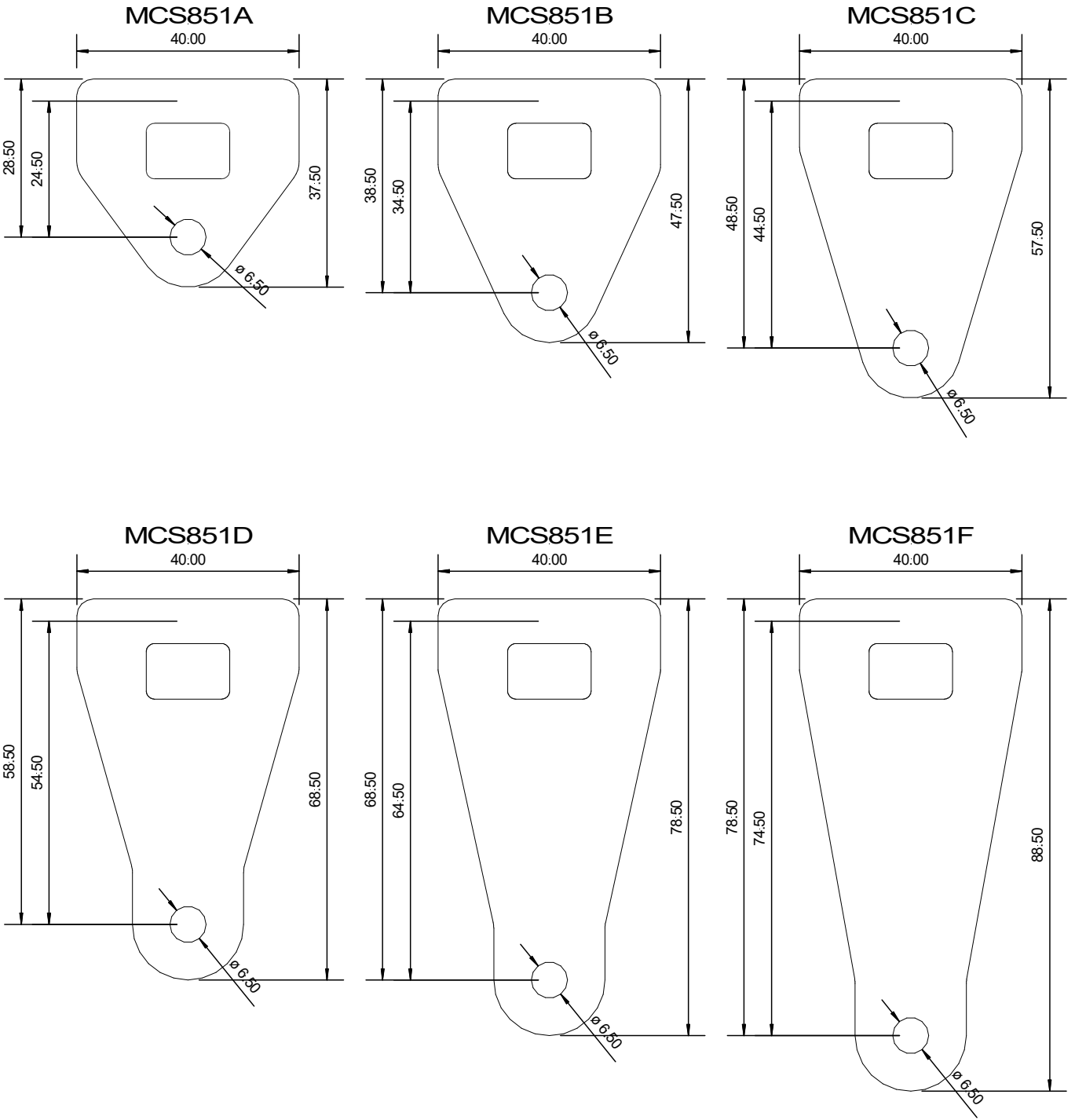

More over page.

These last two brackets are the same basic design, but cut from 2mm thick stainless steel.

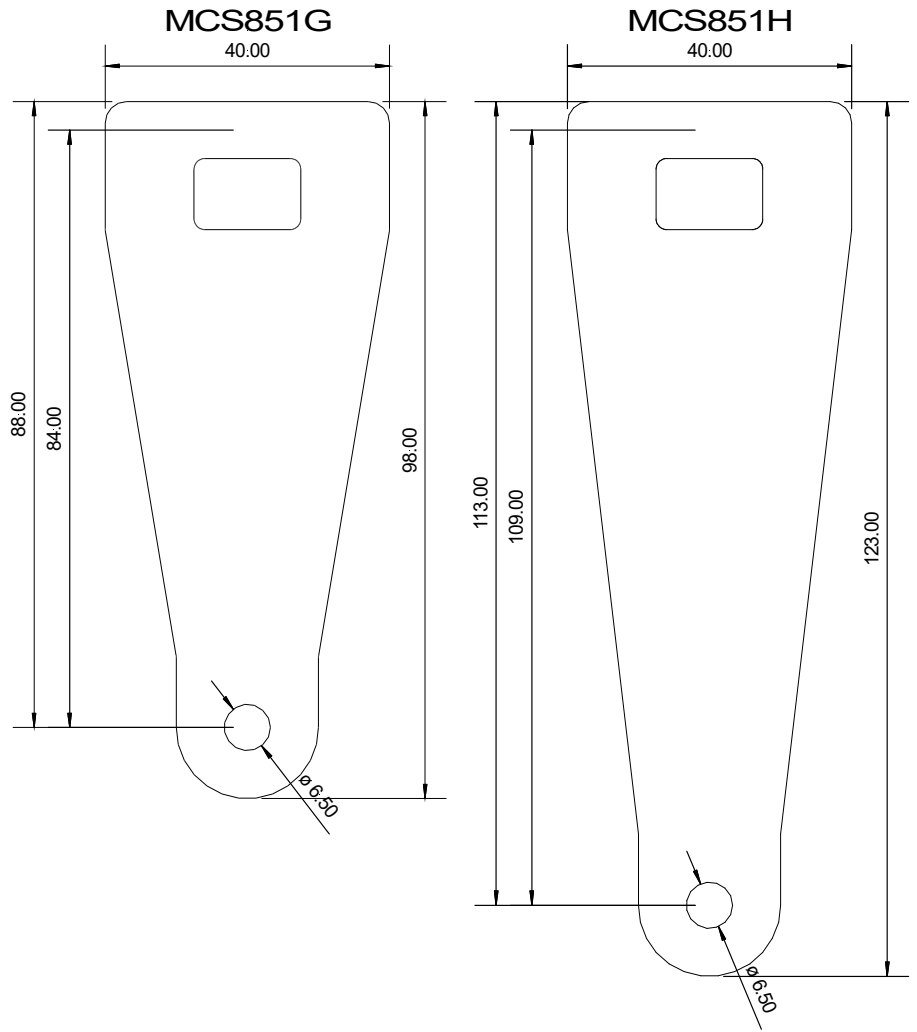



## MCS852 right angle hose clamp tabs

The MCS852 series tabs are designed to use two or three hose clamps, one or two around a frame tube, the other around the throttle servo, when the frame tube is roughly at right angles to the servo tube. The larger 24mm wide tab on the right of the brackets is intended to be attached to the servo, but the tab can be used either way around. The tab must be formed to wrap around the frame tube it attaches to, and formed to match the curve of the servo. Again, two brackets are usually required, but in some cases a cable tie or Velcro can be used instead.

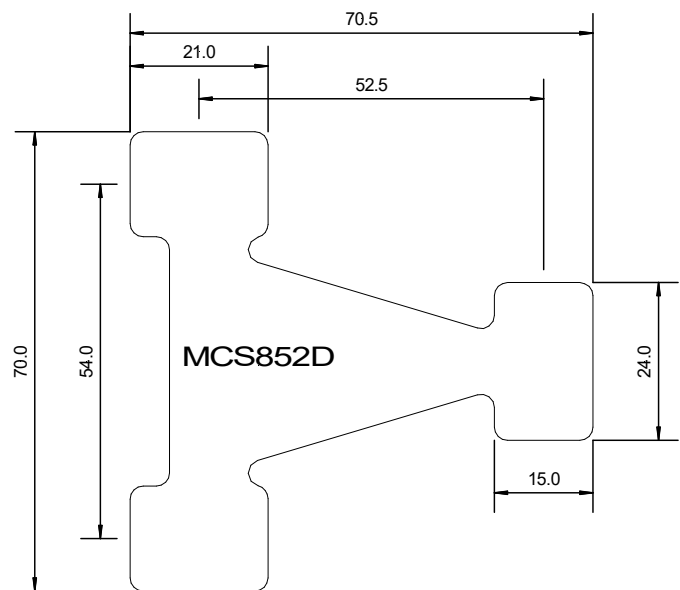
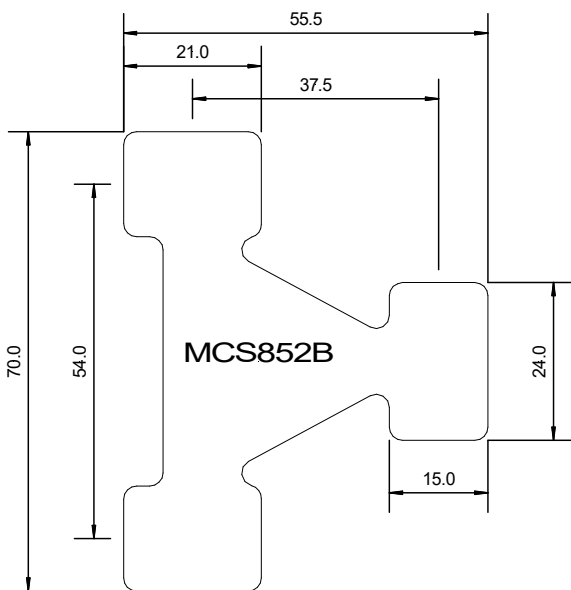
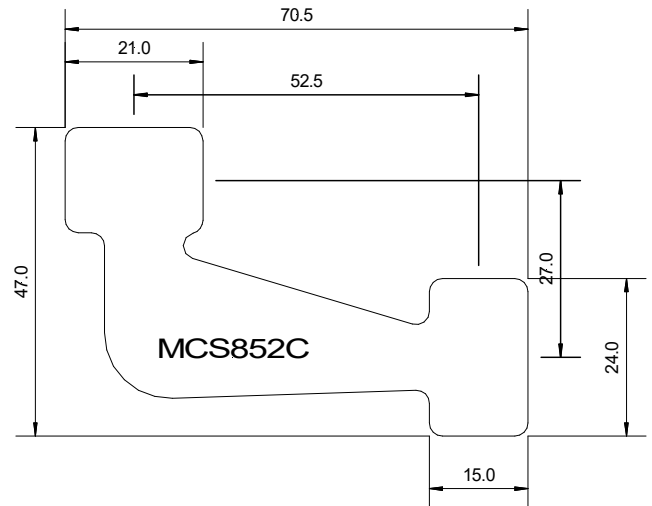
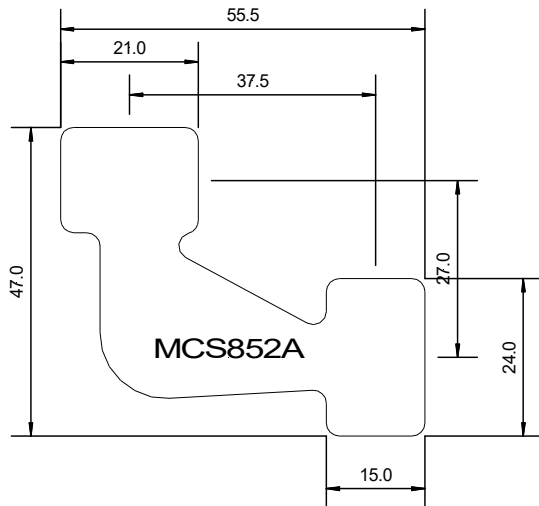

**MCS853 hose clamp brackets.**

The MCS853 series brackets are designed to use hose clamp or clamps to attach to a frame tube and to the throttle servo where the frame tube is parallel to the servo.

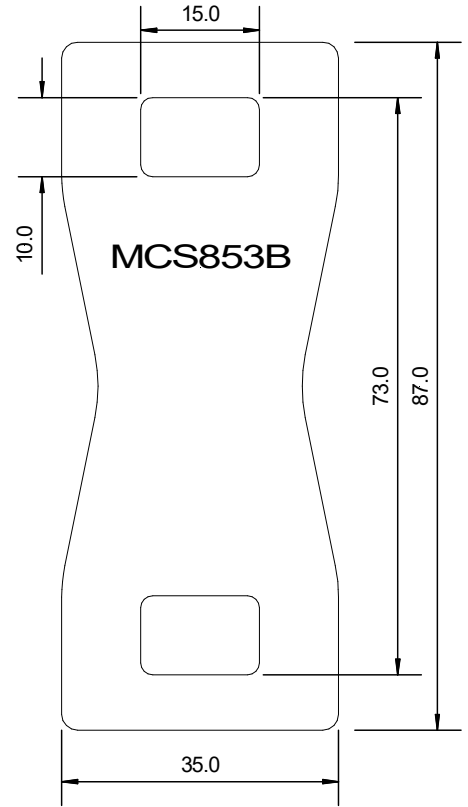
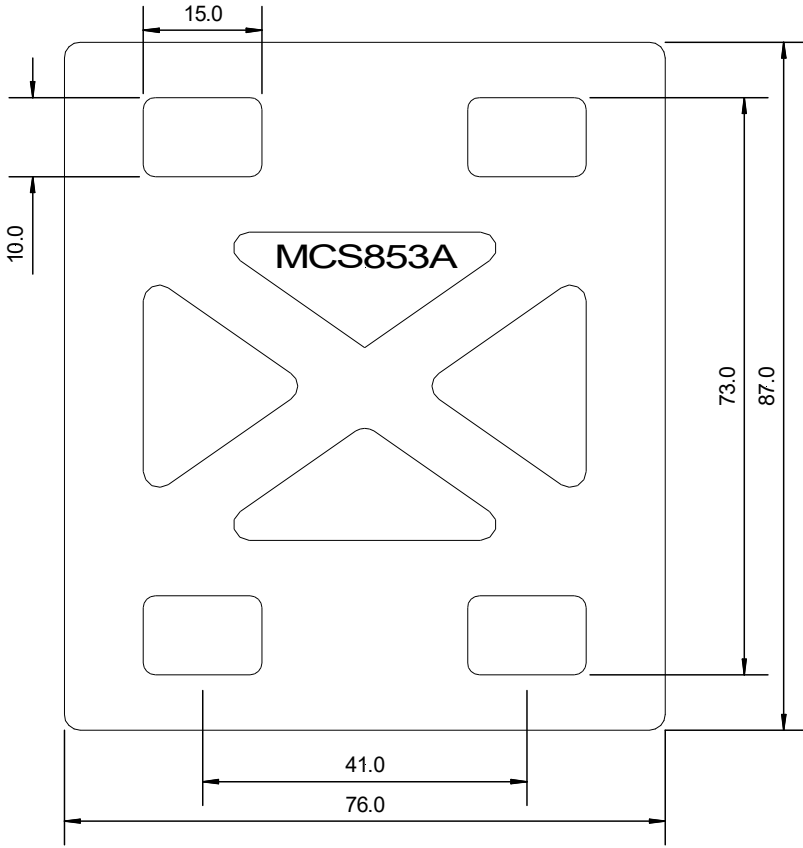

## MCS854 right angle hose clamp brackets

The MCS854 series brackets are designed to use hose clamp or clamps to attach to a frame tube and to the throttle servo where the frame tube is at right angles to the servo. Either end of the bracket can be attached to the frame tube or the servo.

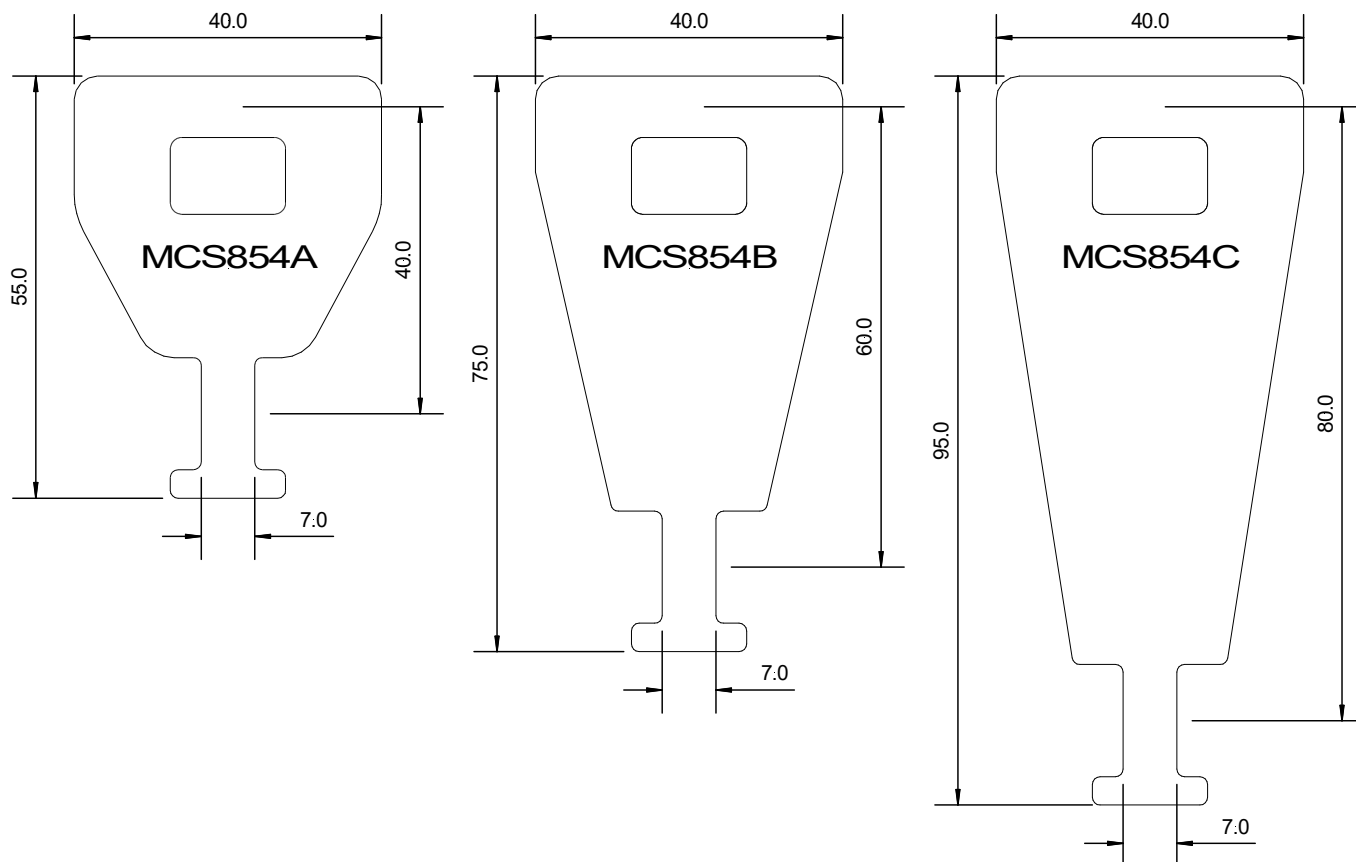

More over page.

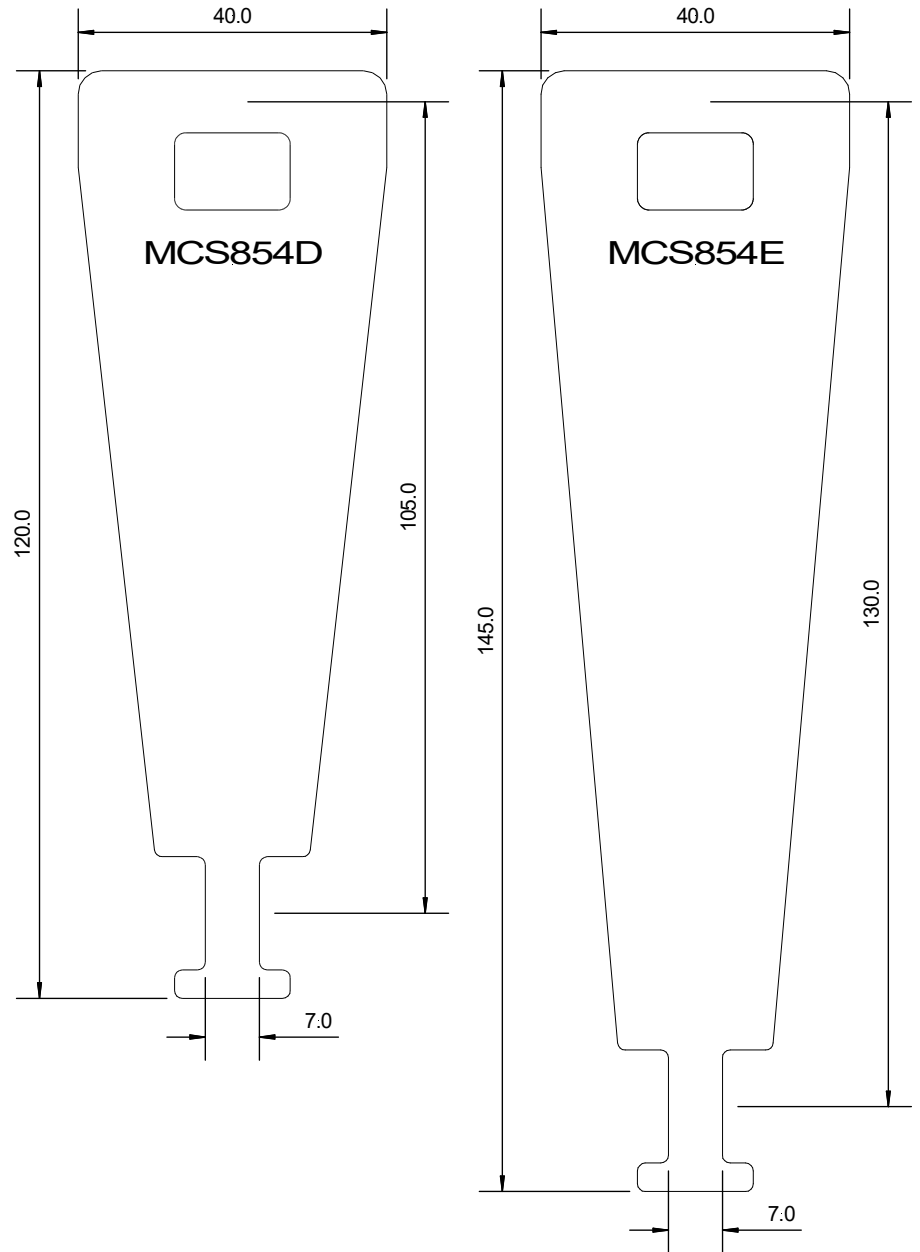

**Remember, the installer must order the brackets needed for the installation. If none are ordered, none will be supplied in the kit.**

## Installation examples.

The following photos and text show several examples of the electric throttle servo mounted on motorcycles using cable ties and Velcro, or just hose clamps on frame tubes, or some of the universal mounting brackets shown previously in this manual.

### Suzuki DL1000 – Velcro & Cable ties.

The throttle servo is mounted in the storage space under the pillion seat using Velcro mounting tape and cable ties. Using cable ties and Velcro is satisfactory in this case, because even if the servo comes loose, there is nowhere for it to go, it is fully contained under the bike's seat.

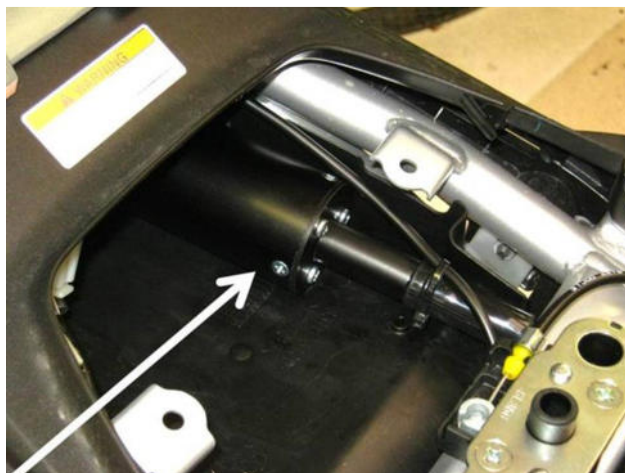

### Kawasaki Versys KLZ1000 – Velcro & Cable ties.

The throttle servo is mounted in the storage space under the pillion seat using Velcro mounting tape and a cable tie. Using cable ties and Velcro is satisfactory in this case, because even if the servo comes loose, there is nowhere for it to go, it is fully contained under the bike's seat.



This cruise control was never released using the vacuum actuator.

### Moto Guzzi Norge – Velcro & Cable ties.

The throttle servo is mounted in the storage space under the pillion seat using Velcro mounting tape and a cable tie. Using cable ties and Velcro is satisfactory in this case, because even if the servo comes loose, there is nowhere for it to go, it is fully contained under the bike's seat.

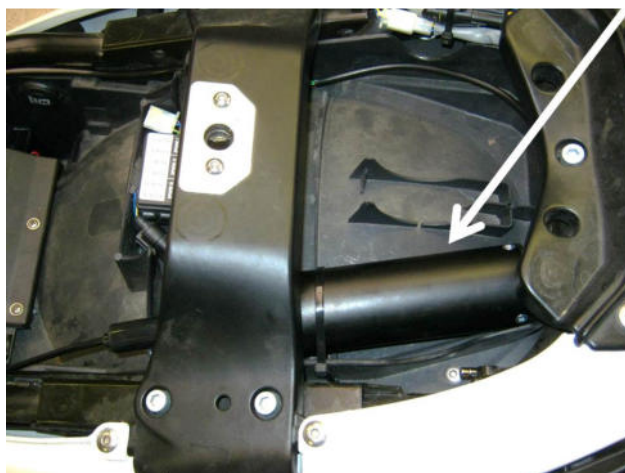

The vacuum actuator was mounted in the fairing on the right side on the earlier version of the cruise control.

### Honda CTX1300 – Velcro & Cable ties.

The throttle servo is mounted on the fairing frame on the right side of the bike. Using cable ties and Velcro is satisfactory in this case, because even if the servo comes loose, there is nowhere for it to go, it is well contained inside the fairing.

This cruise control was never released using the vacuum actuator.

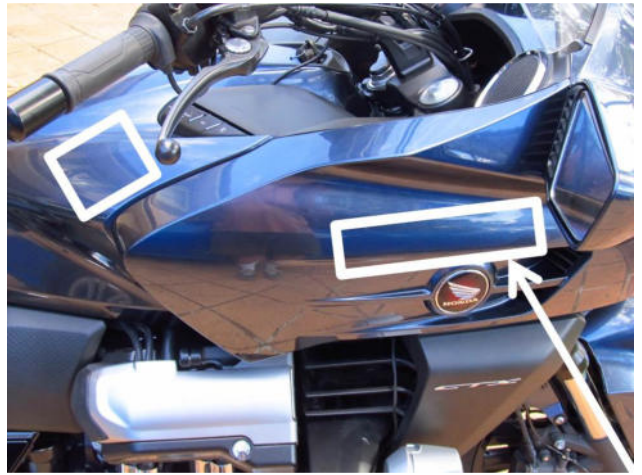

The servo mounts in two places on the fairing frame using cable ties (arrowed) and Velcro to prevent the servo moving around.

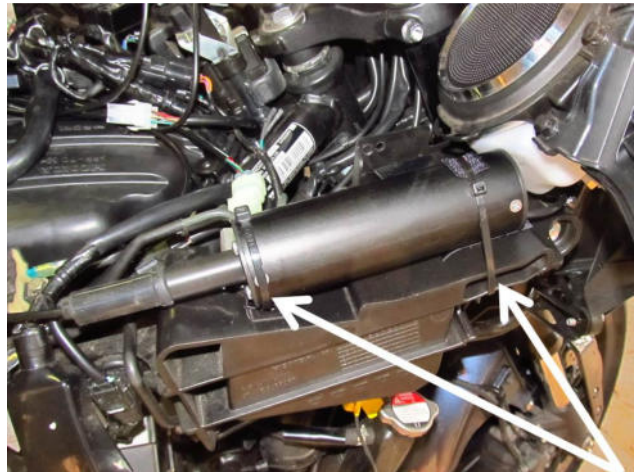

### Harley Davidson Dyna – Hose clamped to frame tube.

In this case the servo is mounted to the frame tube with conventional hose clamps. The hose clamps are covered with black heat shrink tube to improve the appearance and to prevent damage to the paint on the frame and the black anodised finish on the servo.

This cruise control was never released using the vacuum actuator.



### Harley Davidson Softail – Hose clamped to frame tube.

In this case the servo is mounted to the frame tube with conventional hose clamps. The hose clamps are covered with black heat shrink tube to improve the appearance and to prevent damage to the paint on the frame and the black anodised finish on the servo.

This cruise control was never released using the vacuum actuator.



Harley Davidson Sportster – Hose clamped to frame tube.

In this case the servo is mounted to the frame tube with conventional hose clamps. The hose clamps are covered with black heat shrink tube to improve the appearance and to prevent damage to the paint on the frame and the black anodised finish on the servo.

This cruise control was never released using the vacuum actuator.



Honda CRF1000 – Hose clamped to frame tube.

The servo is mounted on the right side of the bike, on the rear sub-frame tube, above the passenger footrest, again using conventional hose clamps.

This cruise control was never released using the vacuum actuator.



Kawasaki Versys KLZ1000 – Hose clamped to frame tube.

The servo is mounted on the left side of the bike, on the rear sub-frame tube, above the passenger footrest, again using conventional hose clamps.

This is an alternative mounting for this bike, the servo may also be mounted under the seat.

This cruise control was never released using the vacuum actuator.



BMW R1200GS – Hose clamped to frame tube.

The servo is mounted on the left side of the bike, on the rear sub-frame tube, above the exhaust muffler, again using conventional hose clamps.

On the earlier version of the cruise control with the vacuum actuator, the actuator was mounted off the same frame tube, but was located in front of the muffler, above the exhaust pipe that runs into the muffler.



Honda CTX700 – Hose clamped to frame tube.

The servo is mounted on the left side of the bike, above the rear of the engine on the frame tube, again using conventional hose clamps.

This installation was done by a customer in USA, we have never seen a CTX700 in our facility.



Ducati Multistrada 1200S – Hose clamped to frame tube.

The servo is mounted on the right side of the bike, on the frame tube, beside the engine, again using conventional hose clamps.

This cruise control was never released using the vacuum actuator.



Suzuki GSX1300R Hayabusa – Hose clamp and cable tie.

The servo is mounted on the right side of the bike, at the rear of the bike under the rear seat fairing.

This cruise control was never released using the vacuum actuator.



A hose clamp is used at the rear of the servo and a cable tie at the front end.

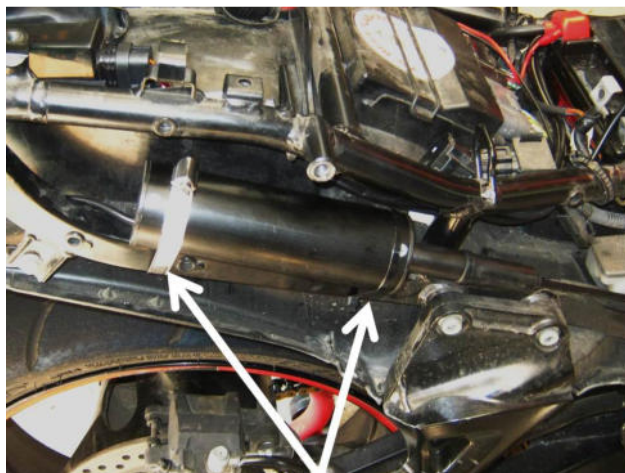



Yamaha XT1200Z Super Tenere – Hose clamped to starter motor.

The servo is mounted across the back of the engine cylinder block to the top of the starter motor using long conventional hose clamps.

On earlier versions of the cruise the vacuum actuator was mounted beside the starter motor, using one of the starter motor mounting bolts.

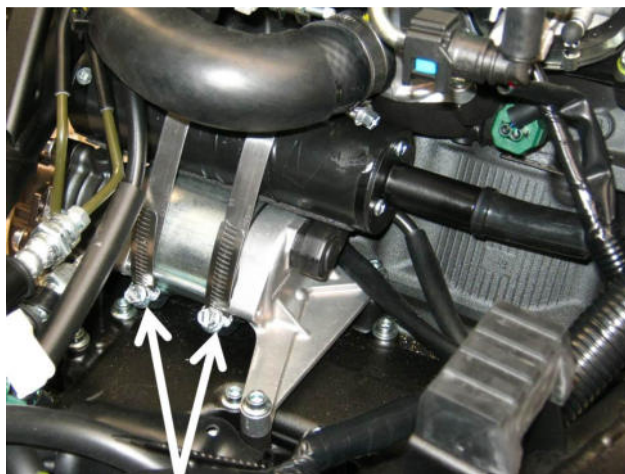

Yamaha MT-09 Tracer – Hose clamped to starter motor.

The servo is mounted across the back of the engine cylinder block to the top of the starter motor using long conventional hose clamps.

This cruise control was never released using the vacuum actuator.

This photo shows the 'back' end of the servo (arrowed), and also shows the two hose clamps.



This photo shows the 'front' end of the servo where the cable comes out (arrowed)



Honda VFR1200X – Universal bracket, hose clamp and cable ties.

The servo is mounted on the right side of the bike, high in the fairing beside the head light.

This model was first released using the vacuum actuator, but it was mounted on the left side of the bike, above the gear shift lever.



This photo shows the servo mounted with the fairing removed.

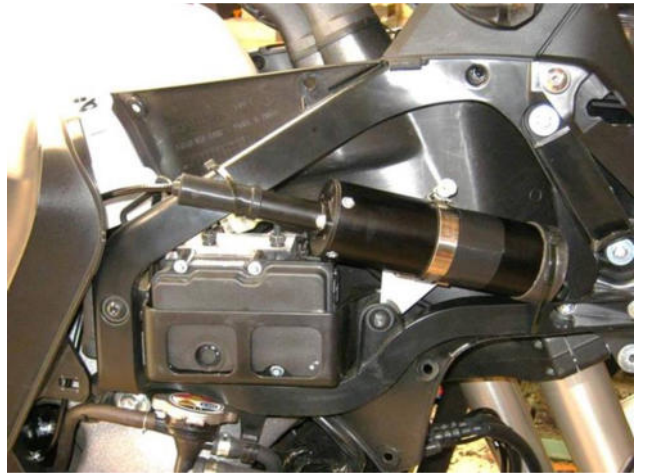

The MCS851C Bracket is used, bent over and mounted on one of the bike's existing fairing frame bolts. A small amount of the bracket near the bolt has to be filed away to allow clearance for the fairing frame.

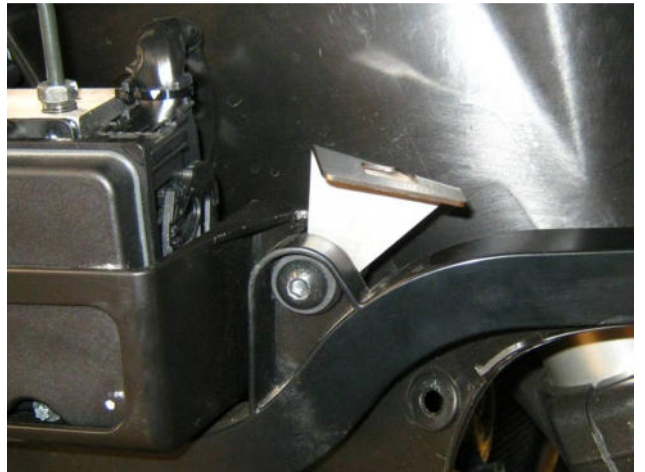

The servo is mounted to the bracket with a hose clamp.

A long cable tie is used to hold the servo to the fairing frame. Self-adhesive foam tape is used around the end of the servo to prevent the cable tie slipping off.

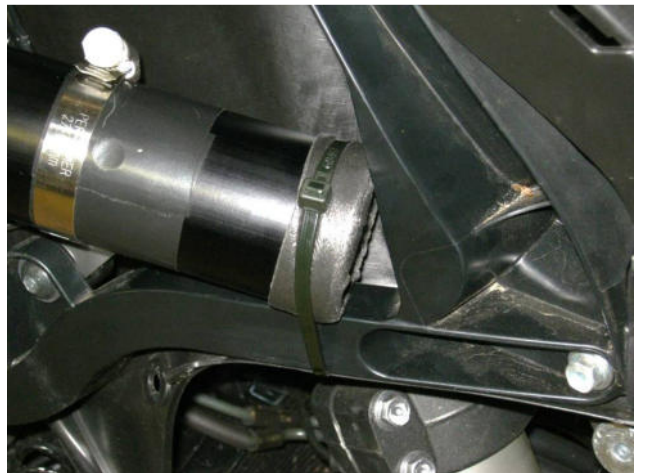

Another cable tie is used at the other end of the servo, again holding the servo to the fairing frame.

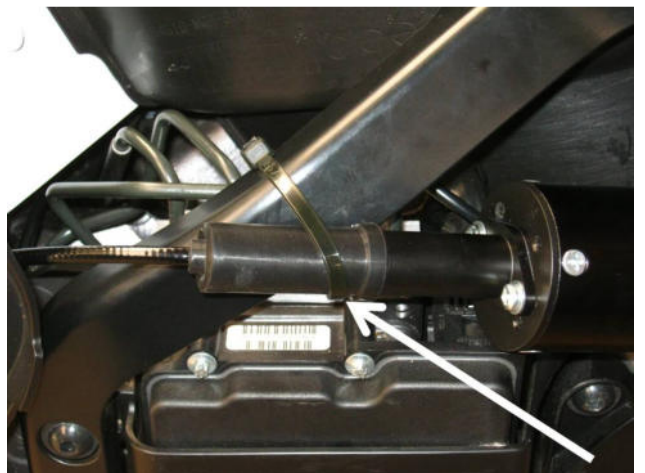

The finished servo mounting, two cable ties, a universal bracket and a hose clamp.



Honda NT700V – Universal bracket, hose clamp and cable ties.

The servo is mounted on the left side of the bike, on the internal engine protection bar (arrowed).

This model was originally released using the vacuum servo, mounted below the engine crash bar, instead of above the bar in this case. Cable routing and other aspects of the cruise control are identical to the vacuum actuator version.



The MCS851G Bracket is used, with a slight bend and mounted on one of the bike's existing engine crash bar mounting bolts.

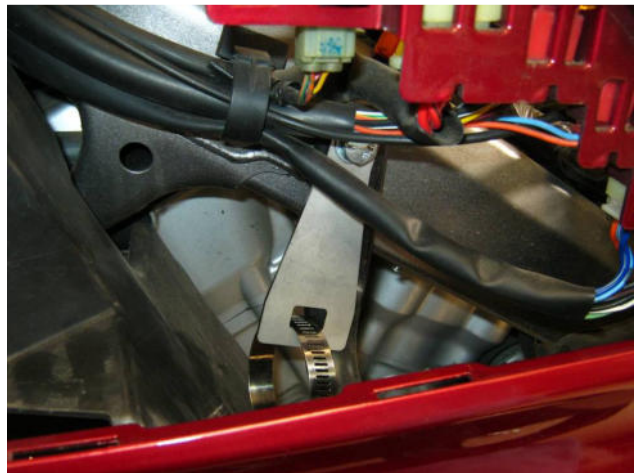

The servo is fitted, and is resting on the crash bar at each end. Two cable ties are fitted, one at each end (arrowed) to prevent the servo vibrating against the crash bar, and to prevent vibration causing the mounting bracket to fatigue.

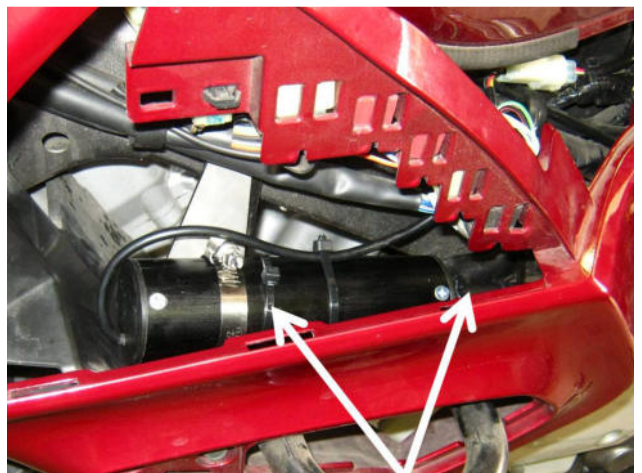

This photo shows the detail of one of the cable ties holding the servo to the crash bar to prevent vibration damage.

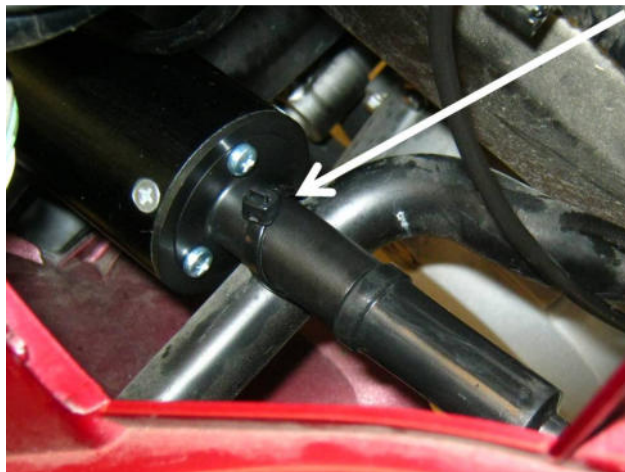

Honda VRF800FI – Universal brackets and hose clamps.

The servo is mounted on the right side of the bike, using existing bolt holes on the frame.

Previous models of this bike had the vacuum actuator, mounted low in front of the engine.



This photo shows the servo mounted with the fairing removed.

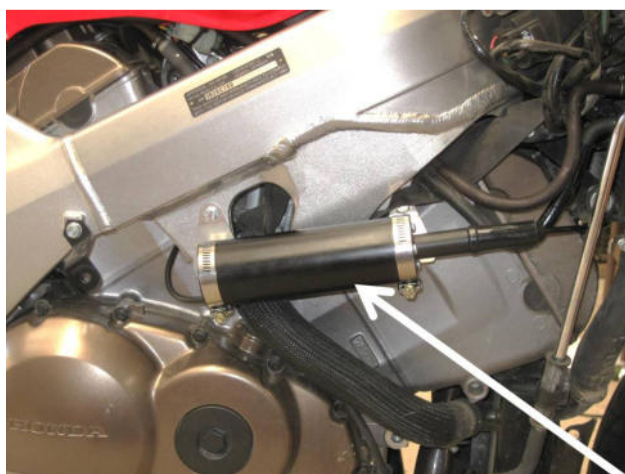

The existing frame bolt hole, these holes have M6 threads (6mm).

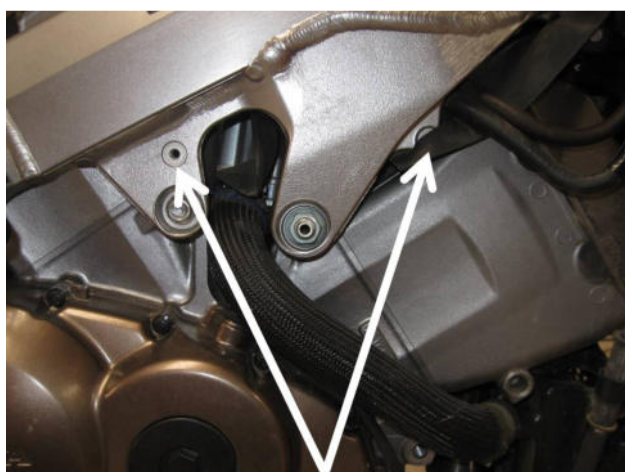

The hardware to mount the servo, two MCS851C brackets, one bent on the end, M6 bolts and washers and two hose clamps.



The brackets fitted to the bike.

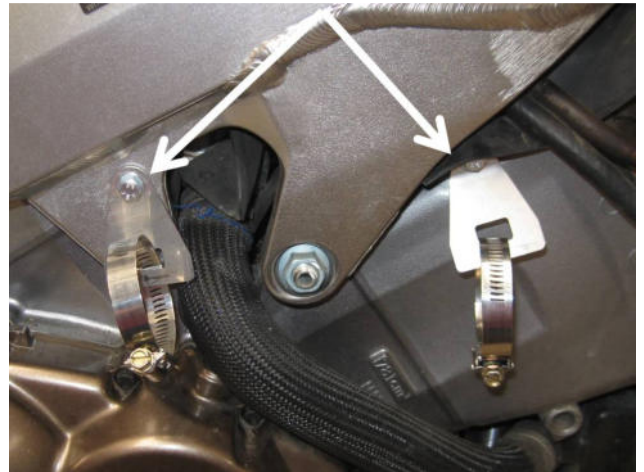

The servo installed on the bike.



### Honda XL1000V – Universal brackets and hose clamps

The servo is mounted on the left side of the bike, using existing bolts that hold the clutch cable bracket.

On earlier versions of the cruise control using the vacuum actuator, the actuator was mounted in the same location.



The hardware to mount the servo, two MCS851C brackets, bent slightly, and two hose clamps.



### Yamaha FJR1300 – Universal brackets and hose clamps

The servo is mounted on the left side of the bike, using existing bolts that hold the passenger footrest mount.

The servo can also be mounted under the rider's seat on this model.

Earlier versions of the cruise had the vacuum actuator either mounted under the rider's seat or on the right side of the motor, between the engine and the radiator.



The hardware to mount the servo, two MCS851A brackets, bent to 90 degrees.



The servo is then mounted on the brackets using two hose clamps.



### Kawasaki Z1400GTR Concours – Universal brackets and hose clamps.

The servo is mounted on the right side of the bike, using existing bolt holes on the frame and the fairing frame tube.

In this case, the vacuum actuator was mounted in almost exactly the same location, but the cable pointed down instead of up.



This bracket is the MCS851D and is attached to an existing bolt on the frame.



The MCS852A bracket is also used to attach the servo to the fairing frame tube.

The large upper hose clamp is attached to the MCS851D bracket shown in the previous photo.



### Suzuki DL650 – Universal brackets and hose clamps.

The servo is mounted on the front of the bike, behind the instrument cluster, above the headlight on the fairing frame.

This cruise control was never released using the vacuum actuator.

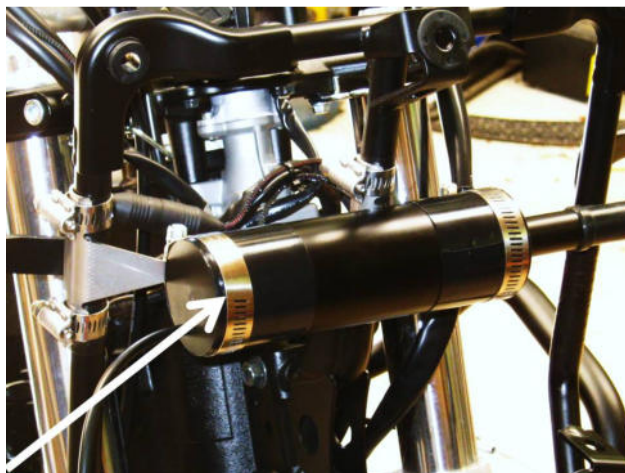

The two mounting brackets, on the left is an MCS852D, on the right is an MCS852C.

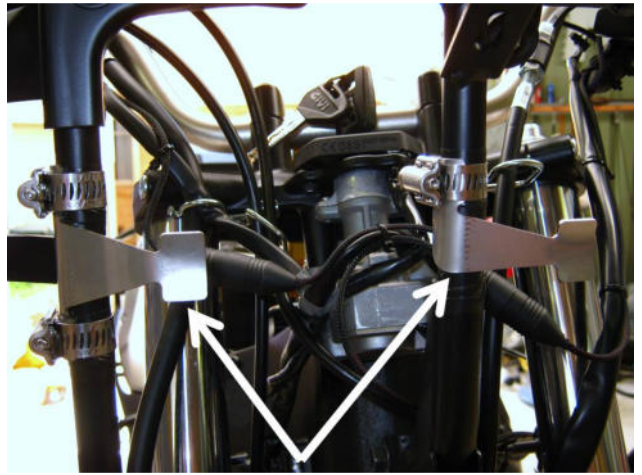

This photos shows more detail of the bends required on the brackets.



The throttle servo fitted to the bike.

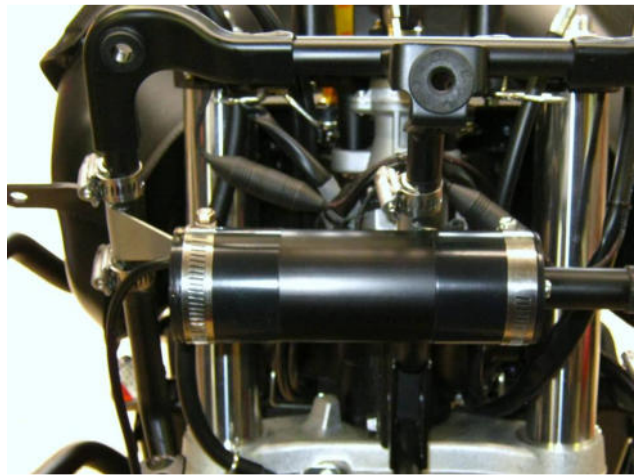

Honda GL1800C Valkyrie – Universal bracket, hose clamps and a cable tie.

The servo is mounted under the rider's seat, beside the battery.

This cruise control was never released using the vacuum actuator.

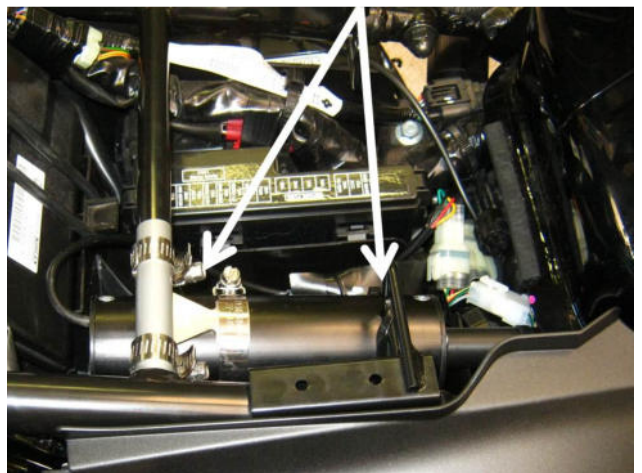



A cable tie is used at the front of the servo and an MCS852B bracket and hose clamps are used at the rear of the servo.

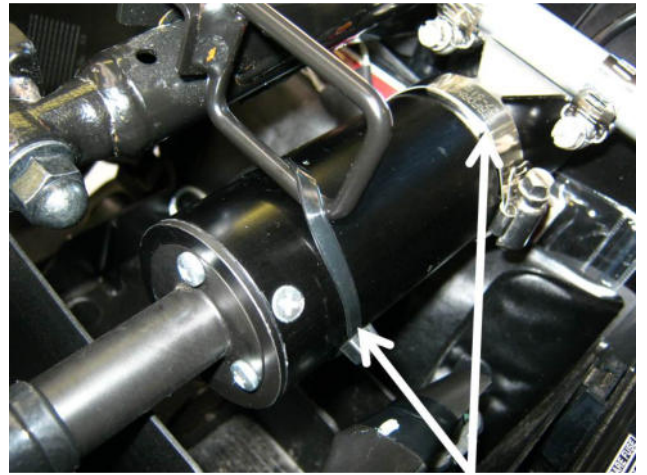

Triumph Thunderbird – Universal bracket and hose clamps.

The servo is mounted on the front of the bike, behind the radiator.

In this case, the vacuum actuator was mounted in almost exactly the same location, but the cable pointed to the right instead of up. This model has a dedicated mounting bracket to hold the bottom end of the servo (lower arrow), and a universal bracket at the top of the servo (upper arrow).



The MCS854C bracket, bent at 90 degrees, and then powder coated in black in this case.



The bracket fitted to the frame, behind the radiator.

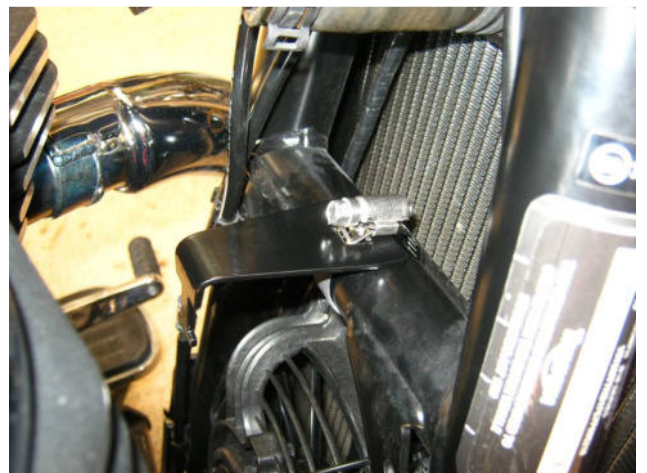

The servo in place with the mounting bracket hose clamped to the servo and the frame.

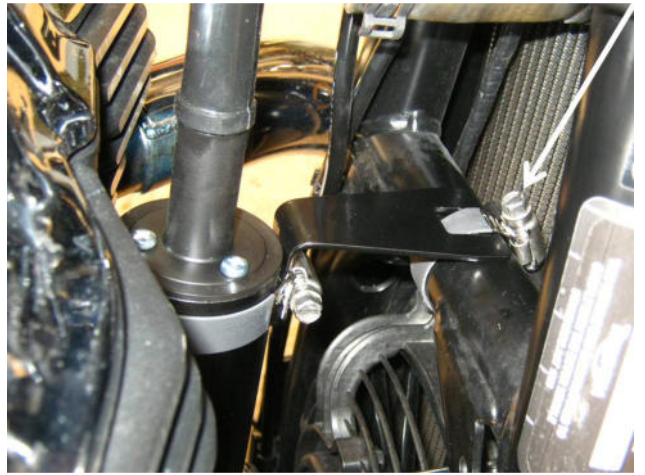

Harley Davidson Electra Glide Sport 1987.

The servo is mounted under the seat, attached to a flat section of frame behind the rear cylinder of the motor.

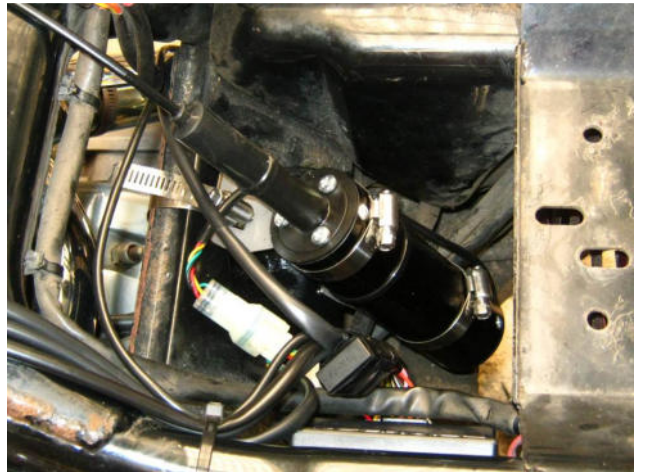

In this case, two different brackets, the MCS854A and MCS854B are used, held to the flat section of frame with a single long hose clamp (HoseClamp #60) wrapped around the frame and going through the two brackets.

The brackets are bent slightly so they sit flat on the frame and on the servo.



The servo is then attached to the brackets using two hose clamps, (HoseClamp #24).



Yamaha FJR1300 – 50mm (2”) pipe support bracket (from a plumbing supplier).

The servo is mounted under the rider’s seat using a plumber’s pipe support bracket.

The servo can also be mounted on the right side of the bike, using the bike’s footrest mounting bolts.

Earlier versions of the cruise had the vacuum actuator either mounted under the rider’s seat or on the right side of the motor, between the engine and the radiator.



**Modifying the mounting brackets.**

The various mounting brackets that we supply are all laser cut from stainless steel. This means that cutting the brackets is possible without causing potential sources of corrosion on cut edges.

The brackets can be modified using a grinding wheel or cutting disc easily.



The brackets can be cut using a fine tooth, good quality HSS (High Speed Steel) hacksaw blade. Use a suitable cutting lubricant on the hacksaw blade to prevent dulling the blade and ease the cutting operation.



Stainless steel tends to ‘work harden’, using a lubricant will reduce heat generation and reduce the tendency of the material to harden.

**WARNING: - DO NOT ATTEMPT TO ENLARGE EXISTING HOLES WITH A NORMAL TWIST DRILL.** The drill bit is likely to catch and will damage the bracket and could cause injury.

Use the stepped drill like the one shown in the photograph. Use a suitable cutting lubricant on the drill bit as well.

Normal twist drills can be used to drill a new pilot hole, again use a cutting lubricant and good quality HSS twist drills.



Use a vice and hammer and a suitable 'tool' to form a curve on a bracket to achieve the correct diameter for the frame tube the bracket has to fit.

This example shows the use on a socket extension bar to form the appropriate radius on a bracket.



**WARNING: - Secure mounting of the servo is critical. It is directly connected to the bike's throttle. If the mounting is not secure and the servo falls off the bike, it WILL pull full throttle.**

**Establishing what size hose clamp to use.**

The following drawings show what size of hose clamp to use with various sizes of frame tube.

If you are using one of our servo mounting tabs/brackets, use a 51mm hose clamp (HoseClamp #24).

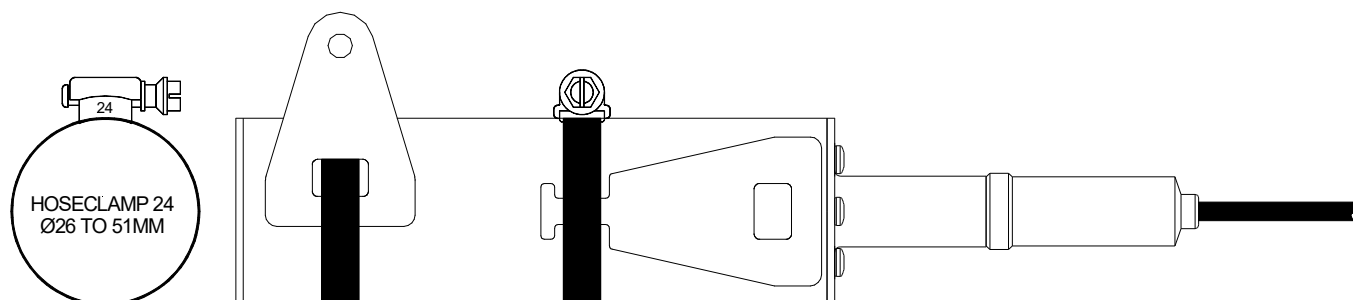

The next series of drawings show various sizes of frame tube and a suggested hose clamp size.

**NOTE: - The installer must order what hose clamps are needed for the installation. If none are ordered, none will be supplied in the kit.**

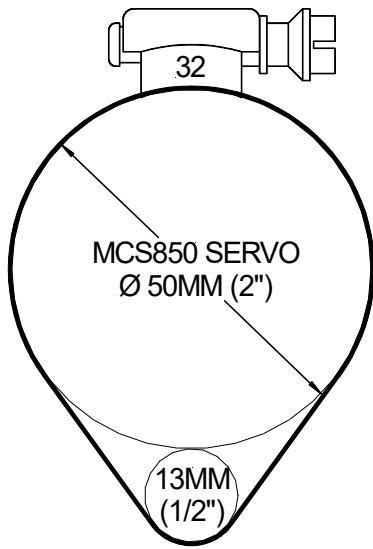

HOSECLAMP 32  
Ø40 TO 64MM

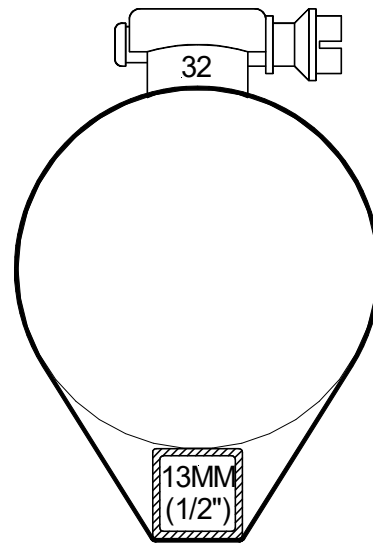

HOSECLAMP 32  
Ø40 TO 64MM

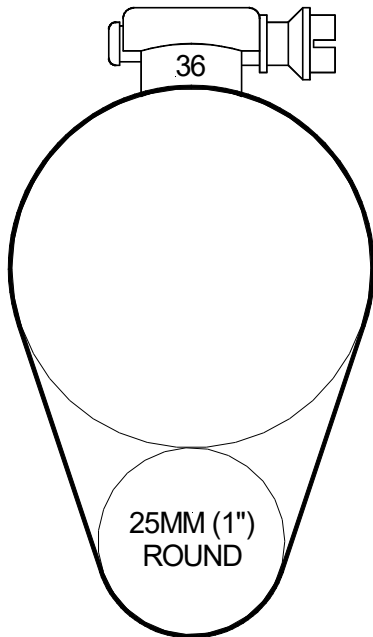

HOSECLAMP 36  
Ø46 TO 70MM

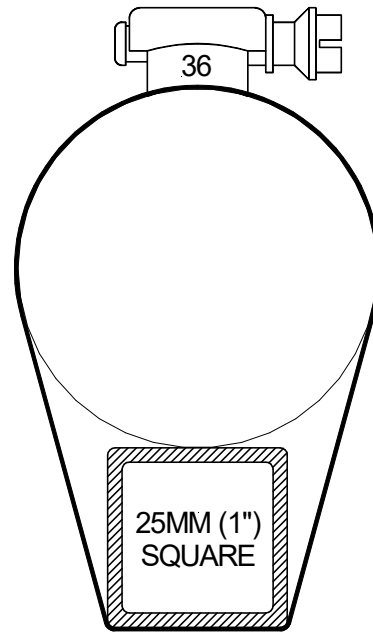

HOSECLAMP 36  
Ø46 TO 70MM

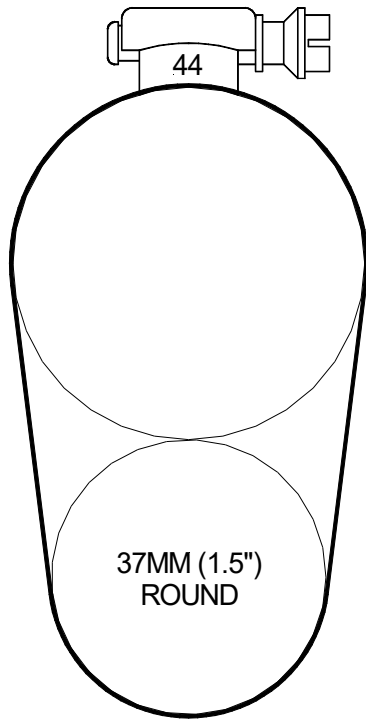

HOSECLAMP 44  
Ø57 TO 82MM

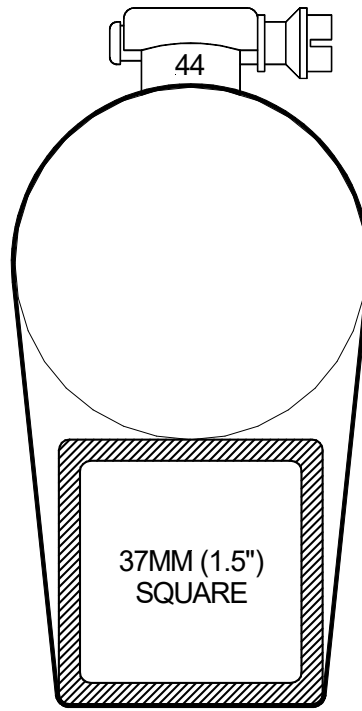

HOSECLAMP 44  
Ø57 TO 82MM

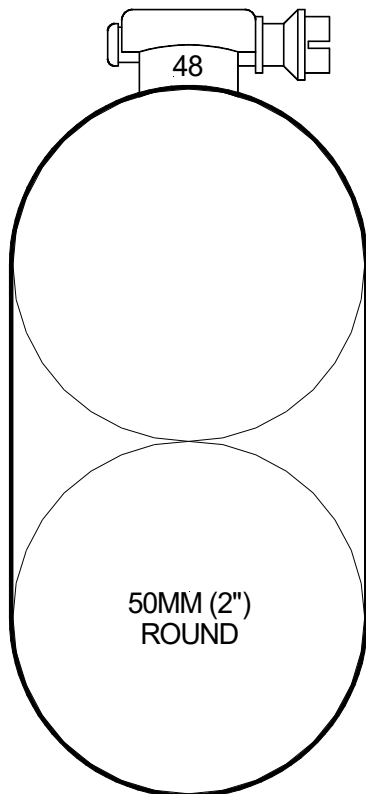

HOSECLAMP 48  
Ø65 TO 90MM

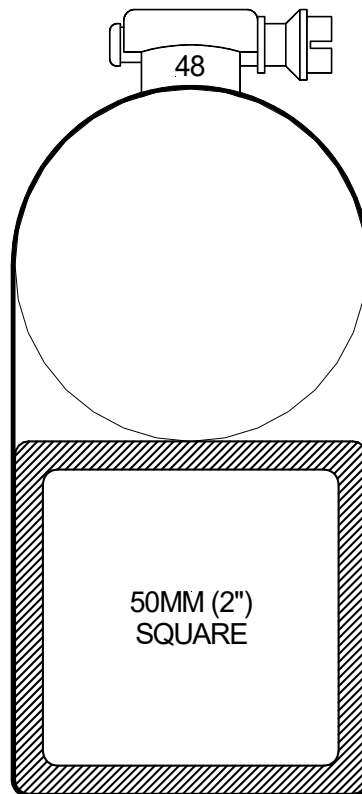

HOSECLAMP 48  
Ø65 TO 90MM

LARGER SIZES ARE AVAILABLE FROM YOUR LOCAL AUTO STORE OR EBAY

## Hose Clamp sizes

The range of hose clamps we carry are shown below in the table. This table has the size # of the clamp, the diameter range it covers and the maximum circumference or perimeter length the hose clamp can accommodate. This is useful if you have a frame tube or something similar you want to attach the servo to directly. Place your 2" PVC tube in position and wrap a length of wire or string around the servo and frame tube. Measure the length of the wire or string to wrap around end to end, then pick the appropriate hose clamp size from the table.

<b>Hose Clamp size #</b>	<b>Diameter Range</b>	<b>Maximum Perimeter Length</b>
HoseClamp #6	8~22mm (5/16" ~ 7/8")	70mm (2 3/4")
HoseClamp #10	14~27mm 9/16" ~ 1 1/16")	85mm (3 3/8")
HoseClamp #12	17~32mm (5/8" ~ 1 1/4")	100mm (4")
HoseClamp #16	21~38mm (7/8" ~ 1 1/2")	120mm (4 3/4")
HoseClamp #20	22~44mm (7/8" ~ 1 3/4")	140mm (5 1/2")
HoseClamp #24	27~51mm (1 1/16" ~ 2")	160mm (6 1/4")
HoseClamp #28	33~57mm (1 1/4" ~ 2 1/4")	180mm (7")
HoseClamp #32	40~64mm (1 5/16" ~ 2 1/2")	200mm (7 7/8")
HoseClamp #36	46~70mm (1 7/8" ~ 2 3/4")	220mm (8 5/8")
HoseClamp #40	51~76mm (2" ~ 3")	240mm (9.5")
HoseClamp #44	57~82mm (2 1/4" ~ 3 1/4")	260mm (10 1/4")
HoseClamp #48	65~90mm (2 9/16" ~ 3 1/2")	280mm (11")
HoseClamp #60	84~108mm (3 5/16" ~ 4 1/4")	340mm (13 3/8")

## Throttle Servo cable length.

The servo cable has to reach from the Throttle Servo to the CIU (Cable Interface Unit), and is connected to the CIU in exactly the same way as the cable from the vacuum actuator was. The installation process of the Cable Interface Unit and the rest of the cruise control is identical to the vacuum actuator cruise control, except that any hardware related to the vacuum connection and the vacuum actuator is not needed.

The drawings below show our servo cable. The length is measured roughly from the inside edge of the caps on each end of the outer cable, so essentially the 'visible' length of the cable with the adjuster fitted to one end and the visible part of the cable outside the CIU.

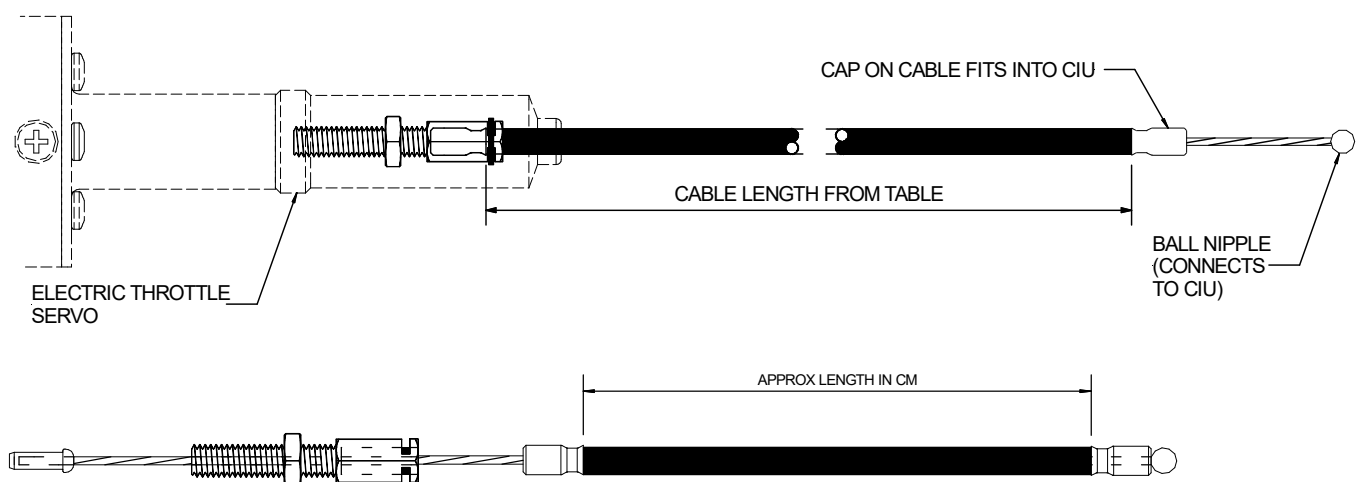

The throttle servo cable is available in the following lengths.

- 100mm (4"). Part number MCSSC100.
- 150mm (6"). Part number MCSSC150.
- 200mm (8"). Part number MCSSC200.
- 250mm (10"). Part number MCSSC250.
- 300mm (12"). Part number MCSSC300.
- 360mm (14"). Part number MCSSC360.
- 420mm (16"). Part number MCSSC420.
- 500mm (19"). Part number MCSSC500.
- 580mm (22"). Part number MCSSC580.
- 650mm (25"). Part number MCSSC650.
- 750mm (29"). Part number MCSSC750.
- 850mm (33"). Part number MCSSC850. This is the default 'standard' part included in the kit if another size is not requested. This cable could be used if the electric servo is in the same location and has the same cable routing as the vacuum servo, as it is the same effective length of the original cable on the vacuum servo.
- 1000mm (39"). Part number MCSSC1000.
- 1150mm (45"). Part number MCSSC1150.

The longest cables will work, and do work quite well in the few installations that we have done that require their use, but if it is at all possible to use shorter cables you should do so. If the longest cables are used, careful and regular attention to lubrication of ALL the cables in the throttle system will be required to maintain satisfactory throttle feel and cruise control performance. This should be done anyway for all cable lengths, but the longer cables make this more necessary.

You can also purchase any of these cables and they can quite easily be 'reworked' to any shorter length desired, using tools available in most home workshops. You do NOT need to be able to solder cable nipples to be able to modify the length of the cable. Detailed instructions are shown over the page to assist with this job if it is necessary.

### **Servo cable custom lengths.**

If the range of cables above are not suitable for your application, or you have a cable that is too long and need to shorten it, follow these instructions.

Once you have worked out the servo location and mounting, you can determine how long the cable needs to be.

Temporarily mount the servo in its final position.

Temporarily mount the CIU (Cable Interface Unit) housing in its final position, or estimate its location from the photos in the installation manual.

### **Servo Cable Custom Length Preparation.**

Cut the **barrel nipple** (NOT the ball nipple) off the end of the cable and pull the inner cable (wire rope) out of the cable.

Remove both adjusters from the cable, one is plain, the other has two slots cut into the hex head for a retaining clip.

Discard the **plain** adjuster (the one without the slots).



**Keep the adjuster with the slots for the retaining clip.**

Remove the rubber boot from the nose of the servo.

Screw the adjuster with the slots for the retaining clip into the end of the servo nose, screw it about half way in.

Place the end of the outer cable in the adjuster in the servo. If necessary, fit the retaining clip to hold the cable in the adjuster.

Route the cable to where the CIU will be mounted.

Make sure the routing of the cable is suitable, not near hot exhaust systems, near any moving parts that might damage the cable, or any other parts that may crush the cable when the bike is re-assembled.

Mark the cable length. The cable must be able to go about 1cm (3/8") into the unthreaded hole with the retaining screw in the CIU. This is the hole at the bottom or closed end of the CIU housing.

**Be a bit generous with the cable length, don't make it too short.**

Remove the cable from the bike.

Unscrew the slotted adjuster from the servo.

Use the following instructions to assemble the servo cable.

**NOTE: - The cable MUST be removed from the CIU and the Throttle Servo. The cable MUST NOT be connected during the construction process.**

**STEP 1: CUT OUTER CABLE TO LENGTH.**  
 USE FINE-TOOTHED HACKSAW OR SHARP CUTTERS.  
 CLEAN UP CUT END WITH FILE OR BENCH GRINDER.  
 ENSURE THE NYLON LINER IN THE CABLE IS UN-DAMAGED AND THE CUT IS CLEAN AND CLEAR OF DEBRIS.

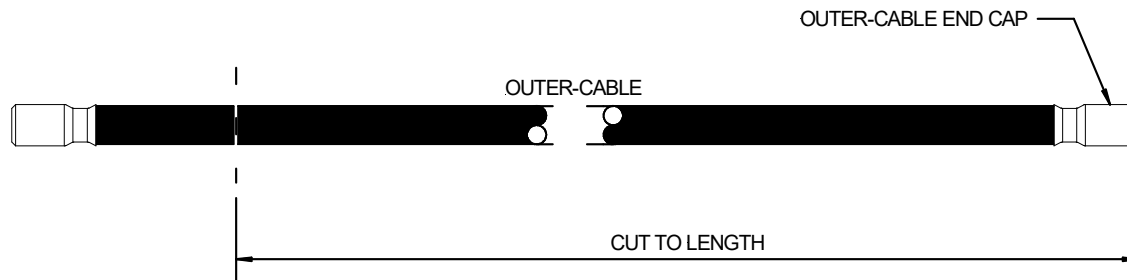

**STEP 2: INSERT INNER-ROPE CABLE.**  
 ENSURE BALL NIPPLE IS AT CAP END.  
 PULL THROUGH ALL THE WAY.  
 MAKE SURE THE CABLE IS COMPLETELY FREE TO MOVE. IF THERE IS ANY BINDING CHECK THE CUT END OF THE NYLON LINER FOR DAMAGE. CLEAN OUT THE END WITH A 1.5~2.0MM DRILL BIT IF NECESSARY



**STEP 3: INSTALL CABLE ADJUSTOR.**  
 ENSURE ADJUSTOR IS SEATED FIRMLY.  
 INSTALL WIRE RING CLIP.

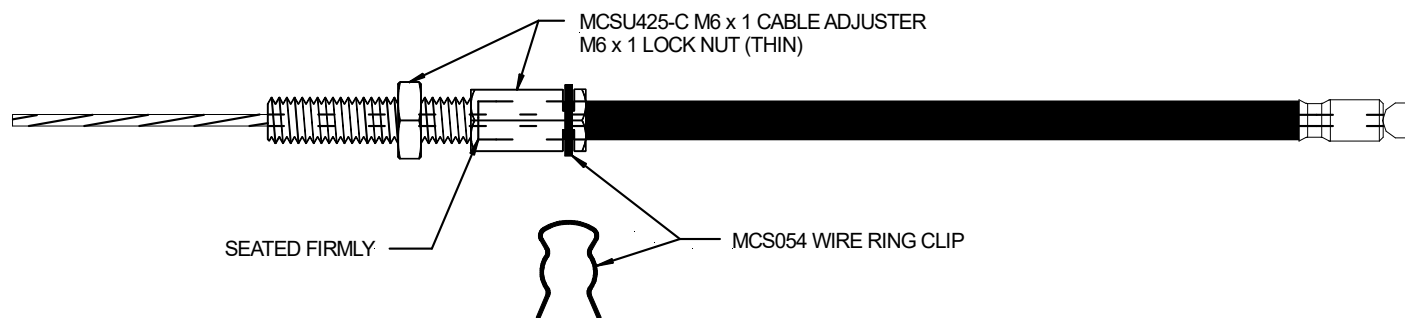

**STEP 4: CUT INNER-ROPE CABLE TO 90MM AS SHOWN.**

**ENSURE ALL COMPONENTS ARE SEATED FIRMLY!**

PLACE A DROP OF HIGH STRENGTH THREAD LOCKING COMPOUND ON THE END OF THE CABLE

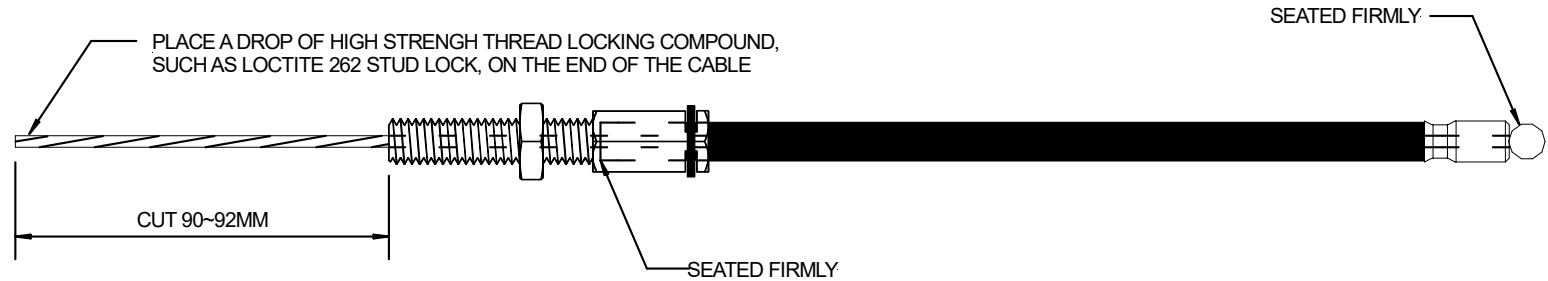

After the cable end is cut, place a drop of thread locking compound on the end of the cable.



**STEP 5: INSTALL INNER CABLE NIPPLE/END CAP. USE PLIERS OR CRIMPING TOOL TO SECURE FIRMLY.**

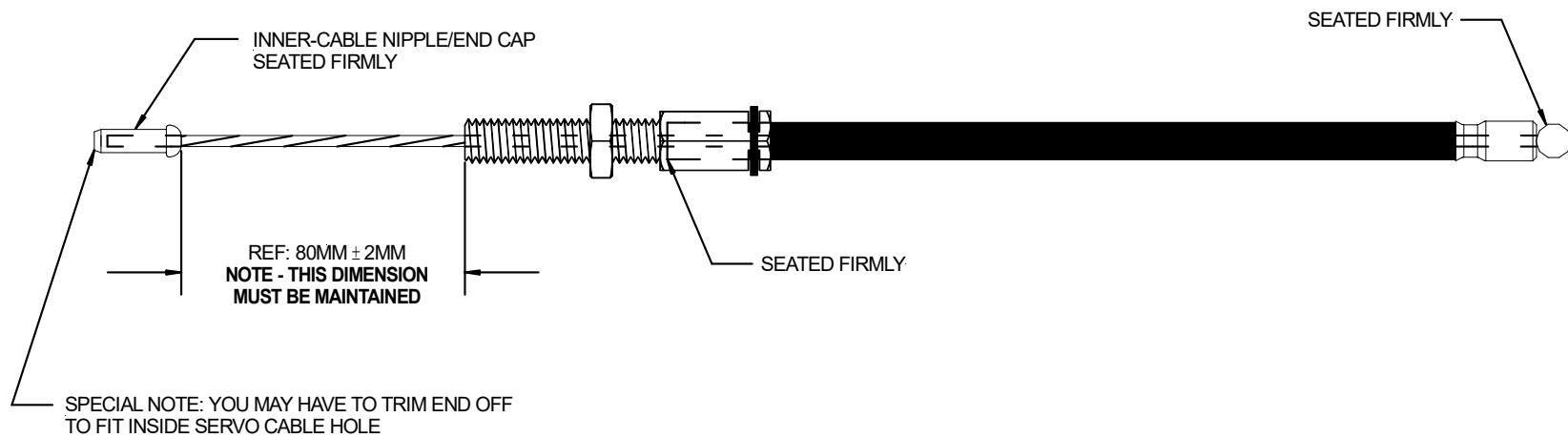

Place the cable end cap on the wire rope inner cable, covering the thread locking compound.

The thread locker will help ensure the end cap will not come off the cable.



Use terminal crimpers or pliers to crimp the end cap to the cable, just behind the collar on the cap.

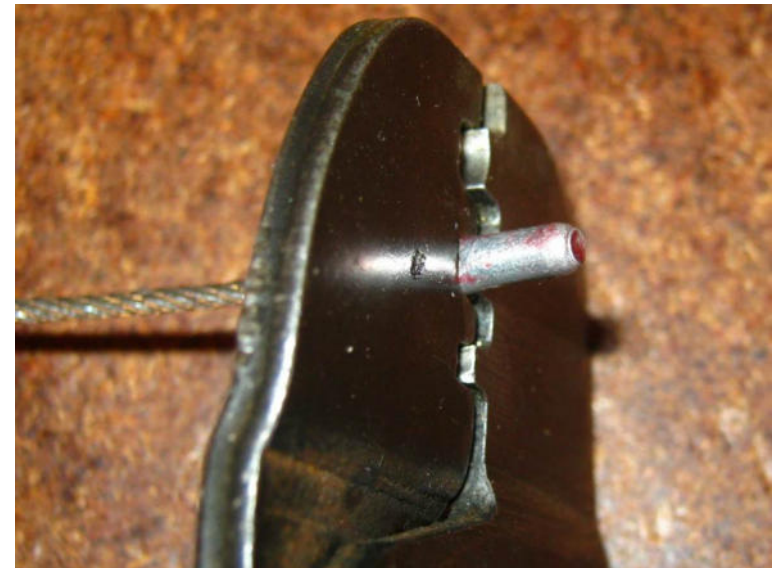

Crimp the cable end cap again, further along the cable.



The cable end with two crimps.

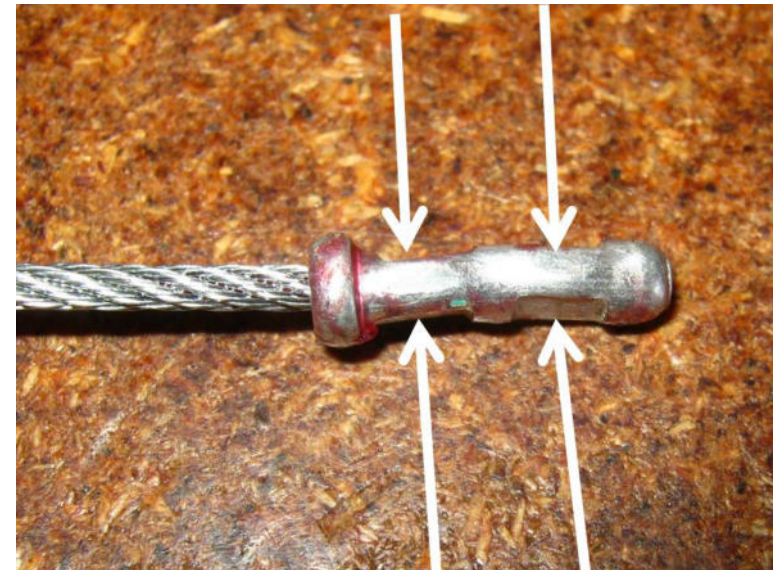

Check if the cable cap will fit in the lost motion device on the servo.

You may need to trim the end of the cap with side cutters.



Try not to cut the cap too short, ideally it should be longer than the slot and hole in the servo lost motion device.



## Installing the servo cable in the servo.

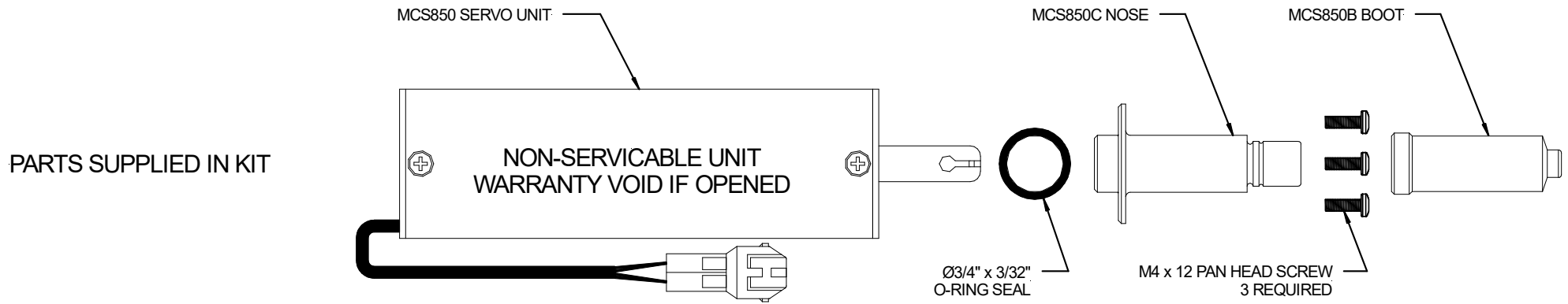

MCS SERVO CABLE ASSEMBLY  
PRE-ASSEMBLED OR  
ASSEMBLED BY INSTALLER

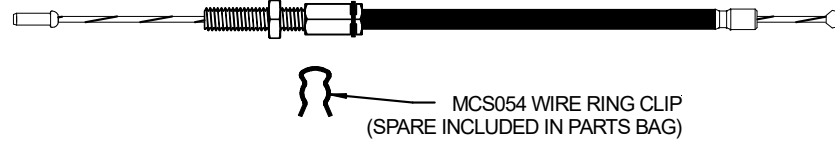

STEP 1: SCREW ADJUSTOR IN TO NOSE PIECE  
LEAVE 8~10 THREADS EXPOSED (8~10MM (5/16"~3/8"))  
DO NOT OVERTIGHTEN LOCK NUT,  
FURTHER ADJUSTMENT WILL BE REQUIRED  
DURING KIT INSTALLATION

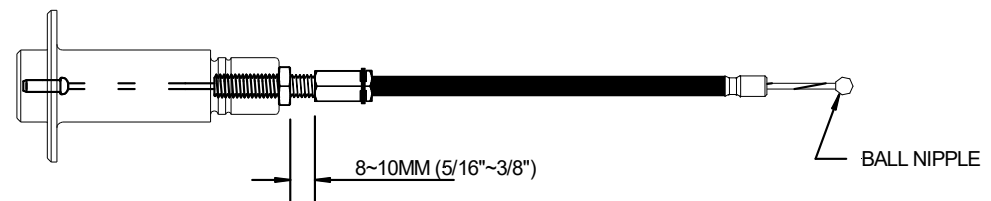

**STEP 2:** SLIDE O-RING ON TO NOSE.  
 APPLY SILICONE (OR TEFLON) SPRAY  
 LUBRICANT (WEATHER SEAL O-RING).

HOOK CABLE NIPPLE IN TO SERVO UNIT.

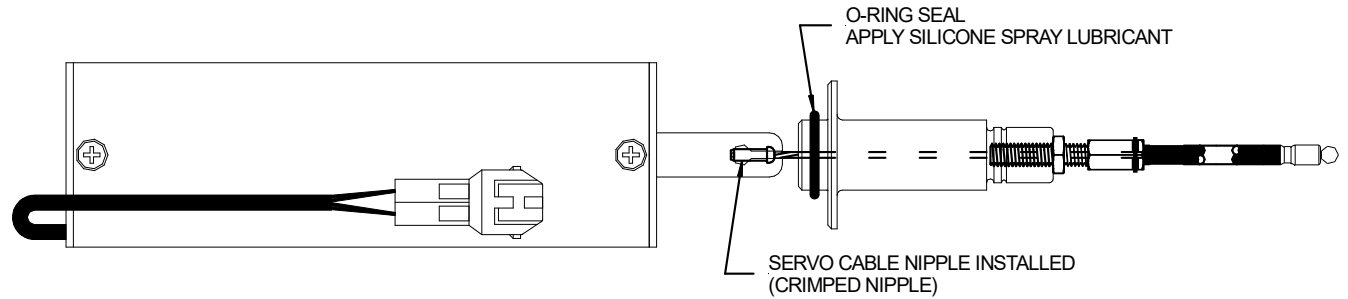

**STEP 3:** APPLY MEDIUM THREADLOCK  
 (LOCTITE 243 OR SIMILAR) TO M4 SCREWS.

SCREW NOSE TO SERVO UNIT BUT  
 DO NOT OVERTIGHTEN SCREWS

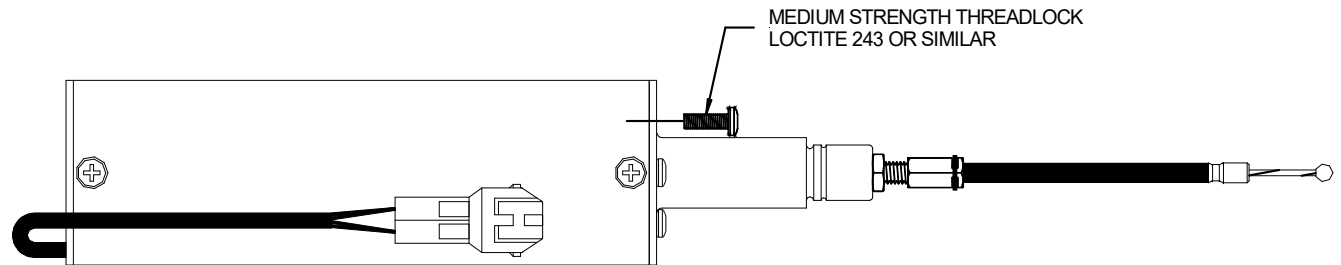

**STEP 4:** APPLY SILICONE SPRAY  
 LUBRICANT TO RUBBER BOOT.

CHECK WIRE RING CLIP IS SECURE  
 BEFORE INSTALLING BOOT.

SLIDE ON TO SERVO.

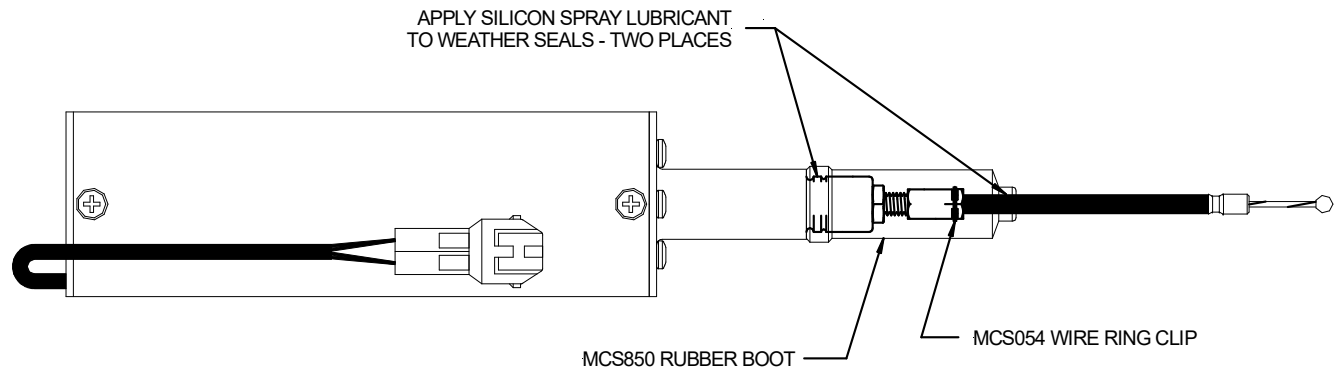



## Electrical connection of the new electric throttle servo.

If you can tell us the length of wire required to go from the cruise control computer to the servo, we can supply the wiring harness complete, based on all the other parts of the cruise control being fitted as per the installation instructions for the vacuum servo. The best way to establish this length is to physically route a piece of wire or thin rope from the location of the cruise control computer plug (refer to the installation instructions for the cruise control) to the location where you are going to mount the electric throttle servo.

The wires out of the end of the servo are approx. 30cm (12") long from the end of the servo to the four way plug in the wires.

The wires to the computer plug must connect to the four way plug and connect to the cruise control computer plug. Route the wires away from high heat (exhaust systems) and away from high voltage (ignition coils or spark plug leads) or high current (alternator wires or starter motor/battery cables) as is reasonably possible. Try to avoid moving parts or stationary parts that may damage the wires, such as mounting point for the seat.

Measure the length of the rope allowing for the 30cm of wire on the servo.

If you don't know what length the wires will need to be from the throttle servo, you will be supplied with a branch of the wiring harness that has the plug for the servo already fitted to it, and you will have to cut the wire to length and fit four terminals that go into the cruise control computer plug, then insert the terminals into the correct hole positions in the computer plug.

A set of these terminals to fit the cruise control computer plug will be provided in the kit.



Using the correct uninsulated (roll) terminal crimper will result in the terminal being crimped to the terminal correctly



If you don't have or did not purchase suitable crimpers, the other option is to solder the terminal to the wire.

Use a pair of pliers to 'close up' the sides of the wire bucket.

**NOTE: - soldering the wire to the terminal is NOT the preferred method, as soldering the wire heats the wire and makes it more brittle and prone to breakage. Soldering must be done as quickly as possible and at the lowest temperature possible to ensure a good solder joint that will not damage the wire.**



Fill the cavity with solder.



Cut, strip and 'tin' the end of the wire.

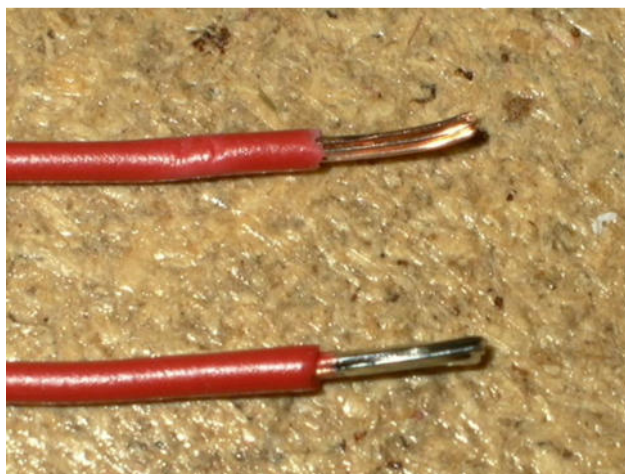

Insert the wire into the terminal and re-heat the solder to allow the wire to go into the cavity.

After the wire and terminal have cooled, use pliers to fold over the tabs on to the insulated part of the wire.



The cruise control computer plug on the wiring harness will have four empty holes in positions 8, 9, 10 & 11 in the top row of the connector.

The holes are for the four wires to the electric throttle servo.

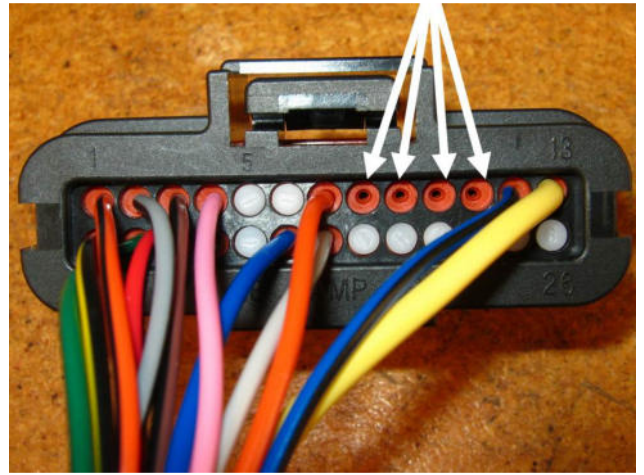

To allow the terminals to be inserted into the connector, the terminal retainer must be 'unlocked'.

Push the three white rectangular tabs on the bottom side of the connector in with a suitable tool. The white tabs will depress about 3mm (1/8").

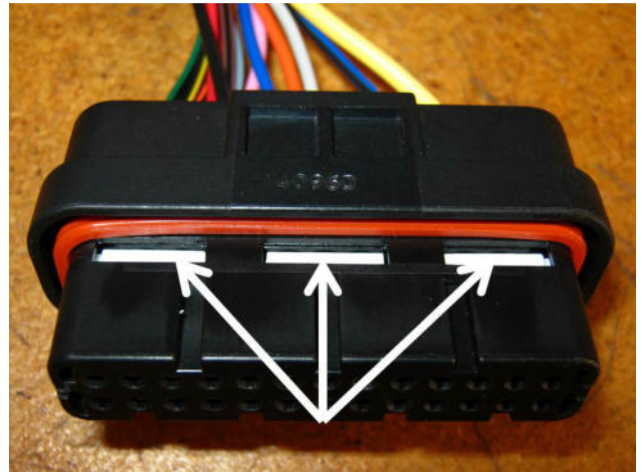

The two white tabs on the top side will protrude about 3mm (1/8").

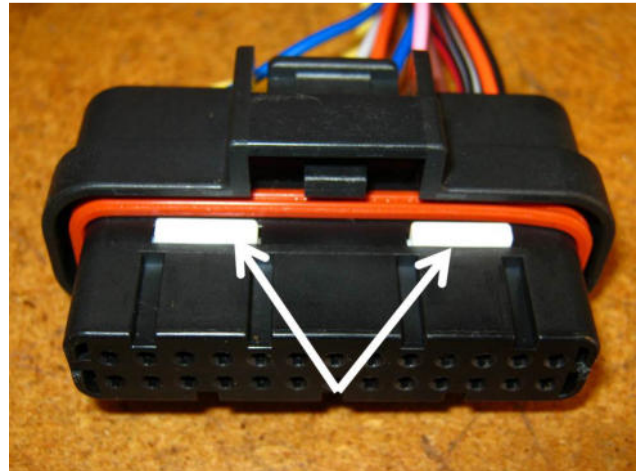

Insert the four terminals on the servo wires into the four holes. Insert the wires in the following positions.

- Black – Position 8
- Red – Position 9
- Yellow – Position 10
- Green – Position 11.

See the diagram over the page for details of the wire positions.

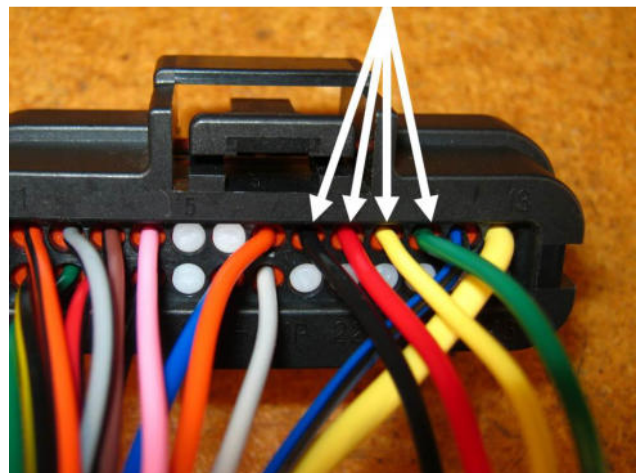

The four servo wires go into positions 8, 9, 10 & 11.

**CAUTION: - These wire positions ONLY apply to the black plastic MCS8000C cruise control computer. If your computer is the earlier aluminium body MCSU400C computer, the wire positions are different. Contact us for wire positions on the older computer.**

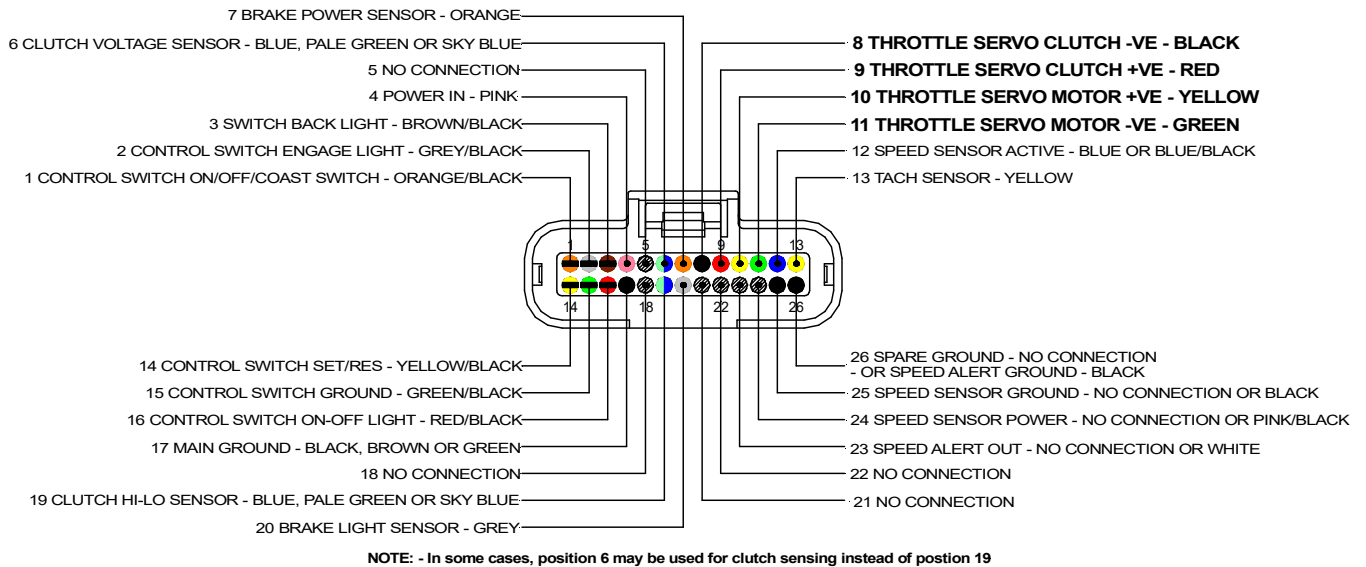

Check that the terminals are visible in the four positions. If the end of the terminal is not visible, the terminal has not been fully inserted.

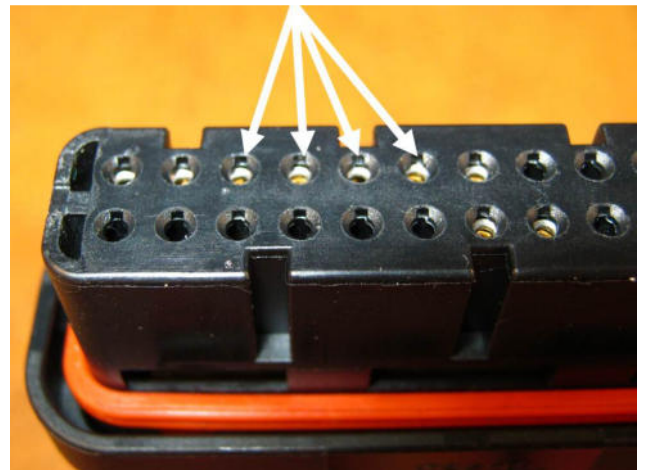

If the terminal will not push home, use the end of an unbent paper clip to push on the back end of the terminal.

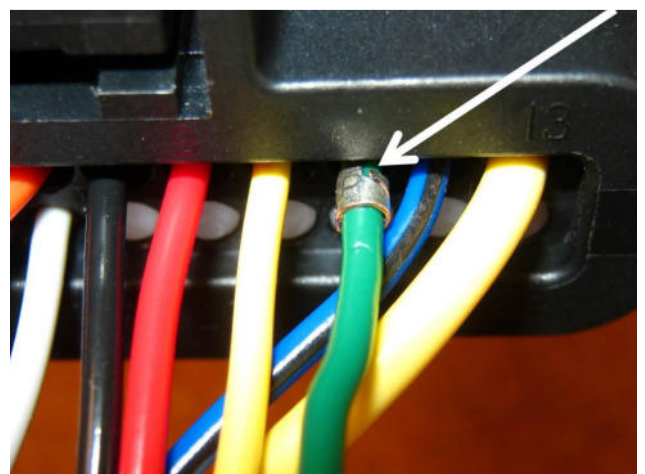

If the terminal will not push home, use the end of an unbent paper clip to push on the back end of the terminal.

Push the paper clip in past the wire seal to push the terminal all the way in to the connector.

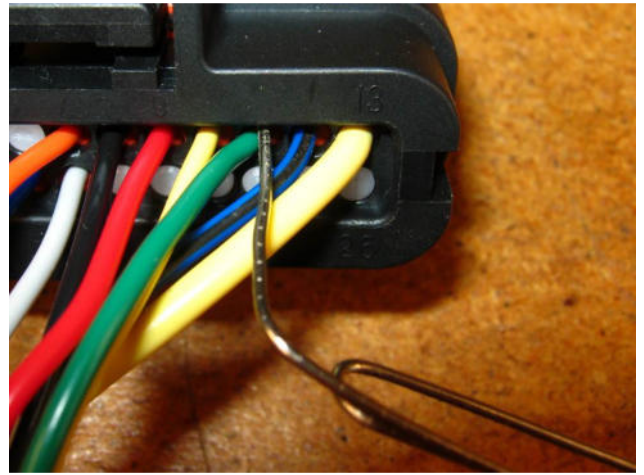

Push the two white tabs down so they are flush to 'lock' the terminal retainer.

**NOTE: - The tabs will not push down if any of the terminals are not fully inserted. Check carefully that ALL the terminals, not just the servo wires, are fully inserted.**

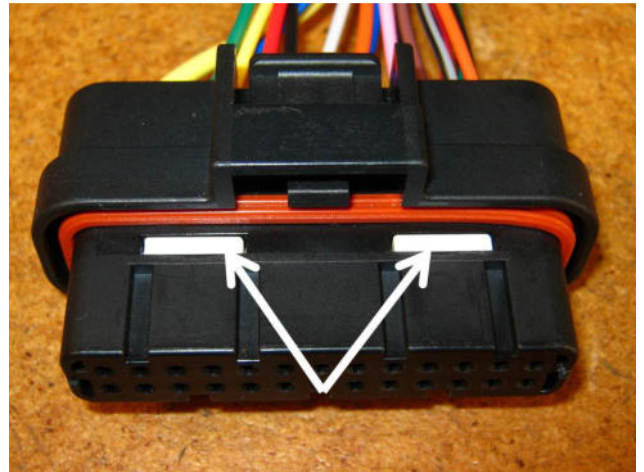

The wiring harness with the servo wires fitted.

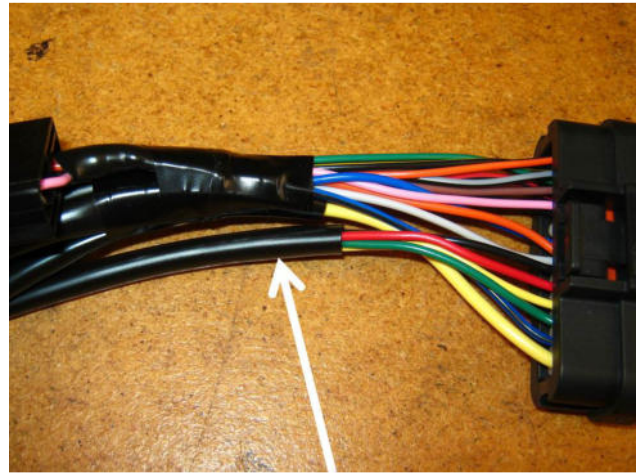

If desired, tape the servo wires to the rest of the harness.

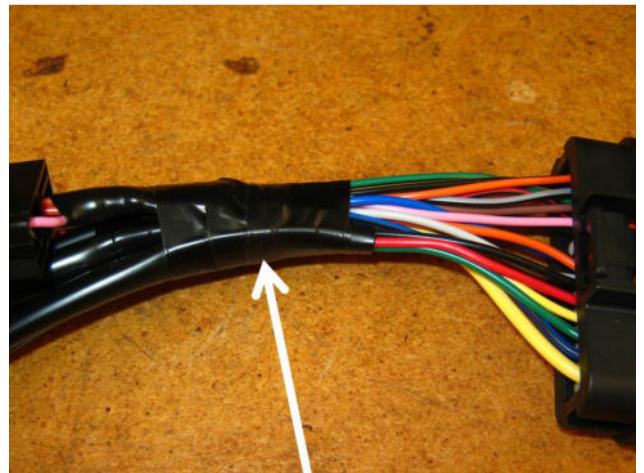

## Mounting the cruise control computer.

A new, smaller, cruise control computer is now supplied in our cruise control kits. This unit has replaced our previous model computer.

Many of our instruction sets are written and photos taken using our previous model computer. This section shows the difference in mounting the cruise control computer.

The parts list in the second or third pages of the installation instruction set will show the part number for 'old' metal box computer as MCSU400C.

The new computer part number is MCS8000C. In cases where the cruise control was developed before the new computer was released this new computer will be supplied, but the old computer will still be shown in the parts list.

Functionally, both computers are almost identical, the new unit has some new designs and abilities, and is more compact and lighter.

The previous model is the one in the metal 'box' at the rear of this photograph.

The new model is in a black plastic enclosure. This model is quite a bit smaller and a lot lighter than the previous model, but still uses the same connector. The latest model still uses a black plastic enclosure like this one, but no longer has a label, the MCS logo is moulded into the top of the box.

**WARNING:** - The wiring 'pin' positions on the new model are different to the old model and the units are NOT interchangeable without re-wiring the connector.



## Mounting the new computer on installations that still show the previous model.

There are several different methods used to mount the previous model computer.

Some installations come with a foam block to mount the cruise control computer.

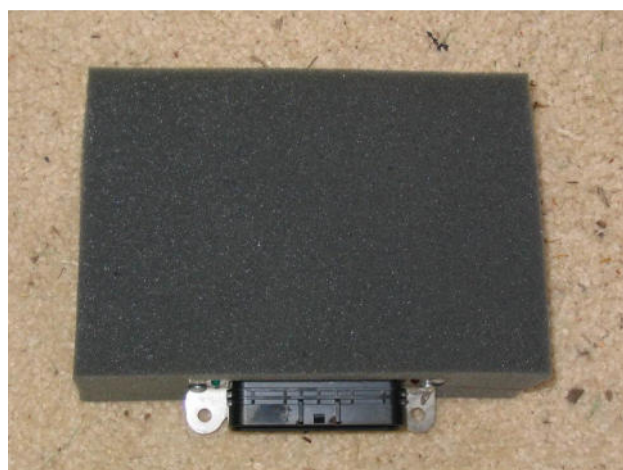

The foam block is then cut to suit the space on the bike.

This method can still be used with the new computer.

In some cases, double sided adhesive foam mounting tape will have been supplied.

In most cases Velcro mounting tape will also be provided in the cruise control kit. This may be used instead of the foam block or the foam mounting tape.

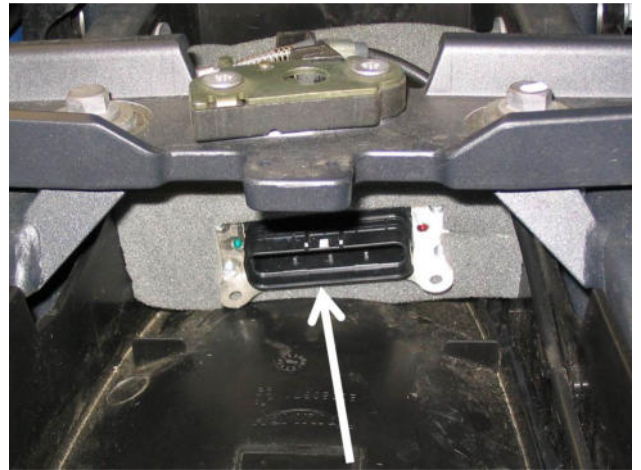

Apply the Velcro tape to the bottom of the computer and use the tape to attach the computer to the bike.

This method is also used where a metal mounting bracket is supplied in the kit to mount the computer.



Where a mounting bracket was supplied, the old computer was attached to the bracket using two or four screws.

The new computer is mounted to the bracket using Velcro mounting tape.

After it is attached using the Velcro tape, place a long cable tie (zip tie) around the bracket and the computer 'box' (arrowed).



This completes the differences in the installation between the old vacuum cruise control models and the changes required to fit the new throttle servo and new computer using instructions from the old vacuum cruise control kit.

## **Throttle, 'Carburettor' and Servo Cable adjustment procedures.**

When you come to the part of the installation that deals with adjustment of the cables, first ensure that the adjuster on the new electric throttle servo is screwed out roughly 8~10mm (8 to 10 turns or 8~10 threads visible on the adjuster), see below.

### **Servo cable initial adjustment.**

Slide the rubber boot off the end of the servo.

Remove the cable retaining clip from the adjuster (arrowed) with a pair of pliers.

**NOTE: - Don't lose the clip. There is a spare in the parts bag if it is lost.**

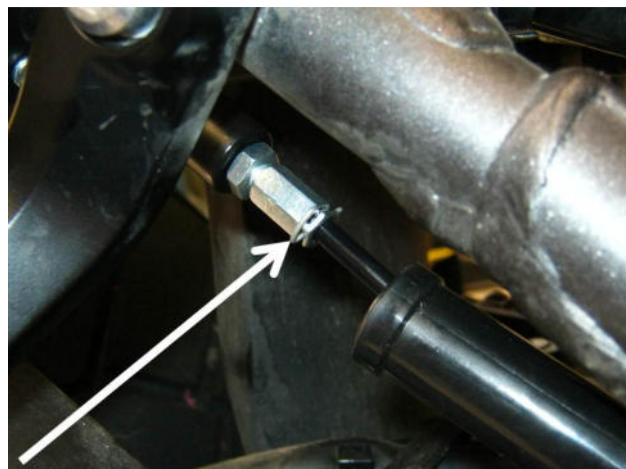

Screw the adjuster out about 8~10 turns, so about 8~10 threads are visible.

Push the cable firmly into the adjuster.

Replace the cable clip if desired, but it will have to be removed again later.



**Now return to the installation manual for the vacuum actuator cruise control, and adjust the 'carburettor' cable and throttle cable per the instructions.**

**When the installation is complete, see below for the final adjustment of the servo cable.**

### **Servo cable final adjustment.**

Slide the rubber boot off the servo and along the servo cable to get access to the servo cable adjuster.

Remove the cable retaining clip (arrowed) – take care not to lose the clip. There is a spare in the parts bag if needed.

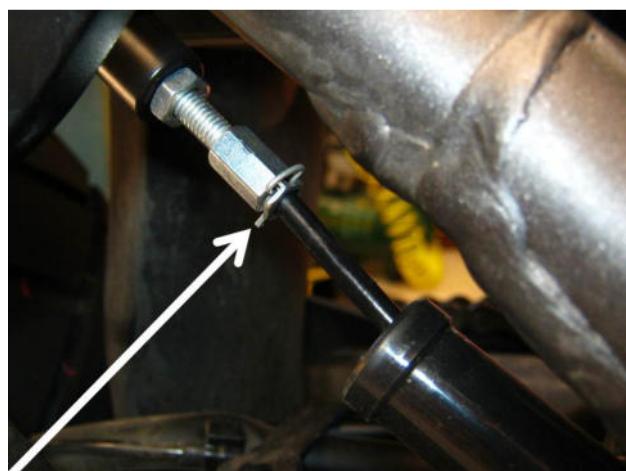



Screw the adjuster on the servo in most of the way to put more free play in the cable.



Press and HOLD the SET/ACC and ON-OFF buttons on the cruise control switch. HOLD both buttons in.

Turn the ignition on. Wait until you hear the cruise control servo operate (about 2 seconds after the ignition is turned on) OR until the lights come on behind the three buttons (back lights), then release the SET/ACC and ON-OFF buttons.

The noise from the servo is the self-test routine; the servo motor will operate for about 1 second, stop briefly (less than ½ second), then operate again for about 1 second and stop. This is normal and will happen each time the ignition is turned on. It also may be too quiet to hear unless you move close to the servo.

Apply and release the brakes. The indicator light on the switch should come on green when brakes are applied and go out when the brakes are released. This confirms that the cruise control is in diagnostic mode, and that the brake connections are correct. If the green light does not come and turn off with brake operation, turn the ignition switch off and start again.

Start the engine.

Apply and the release the brakes. The indicator light on the switch should come on green when brakes are applied, and go out when the brakes are released. This confirms that the cruise control is still in diagnostic mode.

Wait for the engine idle speed to settle to 'normal' idle, this usually takes a couple of minutes.

Press and release the SET/ACC button repeatedly and regularly (1 to 2 presses per second) until the engine revs start to increase, while counting the number of presses. This will probably take 15 to 30 presses of the SET button.

As soon as the engine rpm starts to increase stop pressing SET and press and release the RES/DEC button at least as many times as you pressed the SET button. The engine revs should return to idle as you press the RES/DEC button. Don't forget, press the RES/DEC button AT LEAST as many times as you pressed the SET button.

Screw the adjuster on the servo cable out until the engine rpm just starts to lift off idle speed.

Slowly screw the adjuster back in until the engine just returns to idle speed.

Make sure the cable is fully seated in the adjuster (push it in to the adjuster) and screw the adjuster out and in to find the point where the engine idles normally, but there is NO free play in the cable.



Gently tighten the lock nut on the adjuster while holding the adjuster to stop it turning.



Firmly push the cable into the adjuster and re-fit the cable retaining clip.

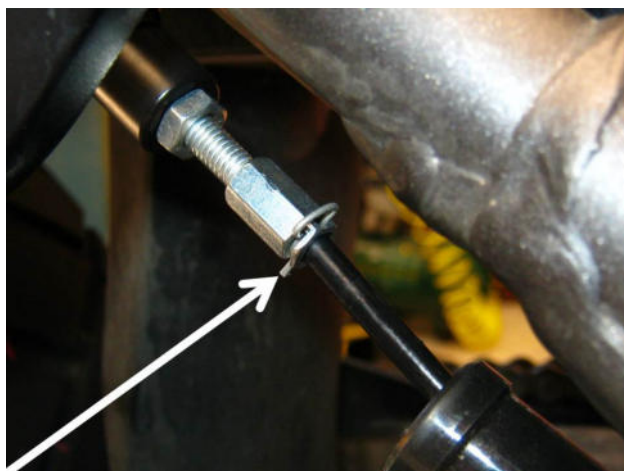

Apply and release the brakes, wait a couple of seconds after releasing the brakes.

Press the SET/ACC button and count the presses. After about 7 to 12 presses, the engine speed should start to increase. Keep pressing until the engine speed is about 2000~3000 rpm.

Now press the RES/DEC button several times until the engine drops to idle. If it does not quite drop to idle, you will have to screw the servo cable adjuster IN a bit more to give more free play.

Press the RES/DEC button at least 10 times more.

Press the SET/ACC button, the revs should start to increase within 1~3 presses. If it takes more than 3 presses to get any increase in engine speed, screw the servo cable adjuster OUT a bit to remove free play.

Try going up and down with the SET and RES buttons several times, always press the RES button at

least 10 times extra after the revs return to idle.

Using this method, the engine revs should increase within 1~ 3 presses of the SET button, and RES should reliably return the engine speed to idle.

Apply and release the brakes, wait a couple of seconds after releasing the brakes.

Press the SET/ACC button; it should take roughly 7 to 12 presses of the SET button to lift engine speed off idle.

Apply and release the brakes.

The engine should instantly drop to idle.

Turn the ignition off.

**NOTE: - This adjustment is critical to good cruise control performance. It must be done correctly.**

Replace the rubber 'boot' on the throttle servo nose.



**Your cruise control is now ready for testing!**

## **8. DIAGNOSTIC MODE OPERATION**

Refer to Chapter 8, Diagnostic Mode Operation, in the Information, Set Up and Operation Manual.

We suggest that you re-assemble the bike AFTER the diagnostic test is complete.

Use the section of the installation instructions **'Preparing the bike for cruise control installation'** to assist in re-assembling the bike.

NOTES: