

DENVER™

elite
healthcare



Martina Tierney
Occupational Therapist & Creator of the Denver

“Since becoming an Occupational Therapist 30 years ago, I’ve worked to improve the quality of people’s lives through seating, and every day I see their lives dramatically changed as a result. The results are amazing”



Seating Matters™

Elite Healthcare Ltd.
Phone: +353 (0) 1 8903932
Fax: +353 (0) 1 8903937

Web: www.elitehealthcare.ie
Email: info@elitehealthcare.ie

Dublin: F1 Swords Enterprise Park,
Feltrim Road, Swords, Co Dublin,
K67 E984, Ireland.

Cork: 602 Harbour Point Business
Park, Little Island, Cork, T45 X624,
Ireland.

THE ONLY CHAIRS SUPPORTED BY COMPREHENSIVE CLINICAL EVIDENCE

Download the full research summary here: [Seating Matters Ulster Research Summary](#)

The significant results* have demonstrated what we already believe, that the correct use of clinical, therapeutic seating can lead to:

- ✓ Pressure injury reduction.
- ✓ Improved posture and function.
- ✓ Reduced sliding and falling from chairs.
- ✓ Reduced time spent in bed.
- ✓ Improved comfort and quality of life.
- ✓ Reduced expenditure on staff and resources.

Pressure Injuries

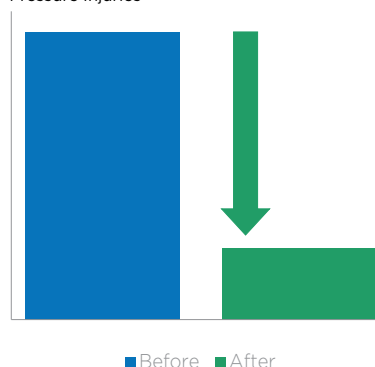

THE FOUR PRINCIPLES OF PRESSURE MANAGEMENT IN SEATING

1. Load the Body

Ensure full body is in contact with the chair to redistribute pressure off bony prominences. Don't forget to load the feet! 19% of body weight goes through our feet.



2. Provide Postural Support

Posture and pressure are inextricably linked. Support any fixed or flexible deviations in posture with the correct seating and accessories to avoid uneven pressure redistribution.

3. Effective Repositioning

Guidelines recommend that seated individuals are repositioned every two hours to increase blood flow to skin. Functions such as tilt in space and back angle recline make this easier.



4. Appropriate Surface

All weight bearing parts of the chair should facilitate immersion, envelopment and support of the patient's body. The Seating Matters chairs are made up of Dartex covered pressure redistributing foam.



The Denver chair has been clinically designed to bring pressure management, posture support and comfort to riser recliner chairs.

The Denver has full pressure care materials throughout the sitting surface, adjustable posture supports and a stand assist riser function.

The Denver has dual motors, providing leg elevation and tilt in space positioning as well as adjustable recline angle. The tilt in space combined with back recline can reduce sliding from the chair, while the riser function helps the user to a standing position to promote easier independent transfers.

To help prevent pressure injuries, the Denver is upholstered in Dartex – A multi stretch, pressure management material used in all Seating Matters chair. The Denver includes a high grade memory foam seat cushion and waterfall back rest to provide all day comfort and pressure care.

To provide the best possible fit, the Denver is adjustable in seat depth, back rest configuration and has the option of lateral supports to help maintain posture.

The Denver uses hospital grade materials to ensure easy cleaning and reduce infection risk. All areas of the Denver are able to be cleaned and the cushion can be removed.

For multi-user environments, hospitals and equipment loan stores, the Denver is completely modular and all parts can be replaced.

Suitable For These Conditions

- ✓ People requiring assisted stand function
- ✓ People with deteriorating function and mobility
- ✓ Dementia
- ✓ Parkinson's disease
- ✓ Multiple sclerosis
- ✓ Stroke
- ✓ Pressure ulcers (also known as pressure injuries or bed sores)
- ✓ Moderate kyphosis, scoliosis & lordosis
- ✓ Muscle & joint contractures
- ✓ Oedema (Edema) or swelling of the lower limbs
- ✓ Post-operative rehab needs
- ✓ Spasticity
- ✓ Low muscle tone
- ✓ Support for hip abduction & windswept postures
- ✓ Fatigue

MAIN USES

Aged Care and at Home

Suitable for people who spend long periods seated and require pressure care, posture support and comfort. The riser function helps the user to a standing position to promote easier independent transfers.

Hospital

Suitable for those in high dependency wards at risk of pressure injury and who tolerate sitting in a standard hospital chair. Main wards include HDU, surgical wards, general medical wards, geriatric medicine, stroke and neuro, transitional care and acute care. Can be used for patients who can independently transfer, or stand and transfer with assistance.

The Denver Chair Has:



* Items are optional

DENVER™

Elite Healthcare Ltd.
Phone: +353 (0) 1 8903932
Fax: +353 (0) 1 8903937

Web: www.elitehealthcare.ie
Email: info@elitehealthcare.ie

Dublin: F1 Swords Enterprise Park,
Feltrim Road, Swords, Co Dublin,
K67 E984, Ireland.

Cork: 602 Harbour Point Business
Park, Little Island, Cork, T45 X624,
Ireland.

Denver Chair Features:



Assisted stand function. True rising function, not just forward tilt.

Dual motor - Tilt in space and leg elevation in one motor and back angle recline in another.



Dartex multi stretch pressure management materials throughout all patient contact surfaces. This material is breathable with moisture permeability to ensure that the surface remains dry and comfortable for the user. This material can be wiped down for infection control and hygiene requirements.

Medium to high pressure management cushion, using memory foam. This cushion is removable for cleaning and if you wish to use a different type. An advantage of our memory foam cushions is they do not require maintenance or adjustment for each person, unlike a gel or air cushion. The cushion is also easily replaceable.



Adjustable seat depth with configurable back rest. Armrests can be replaced.



Denver Parts & Accessories

Laterals



Side Pockets



FibreLux Configurable Back

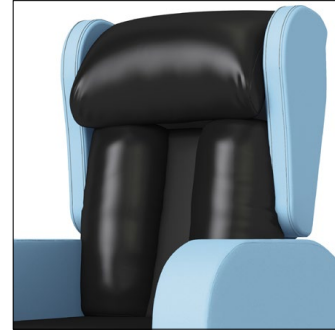

Cushions can go horizontal or vertical for extra support when needed.

Standard Fabric Options

Taurus Cream



Mocha



Cobalt Black



Other colour options are available for volume purchases.

Denver Technical Specifications

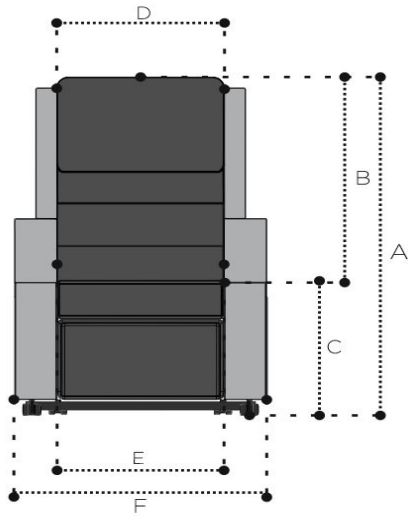

Basic dimensions

A	Overall height	1090mm/43in
B	Back height	690mm/27in
C	Seat to floor height	400-500mm/16-20in
D	Inside back width	495-595mm/20-24in

Chair and overall length

E (Seat width)	F (Overall widths)
450mm/18in	700mm/28in
500mm/20in	750mm/30in

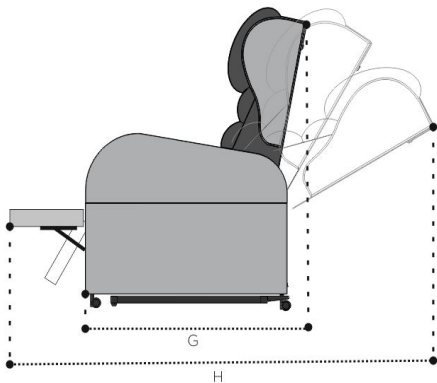

Seat depth back position

I	Position 1	457mm/18in
J	Position 2	559mm/22in

Tilt angle

K	Forward tilt	35°
---	--------------	-----

Overall chair length when fully reclined and tilted

H	1700mm/67in
---	-------------

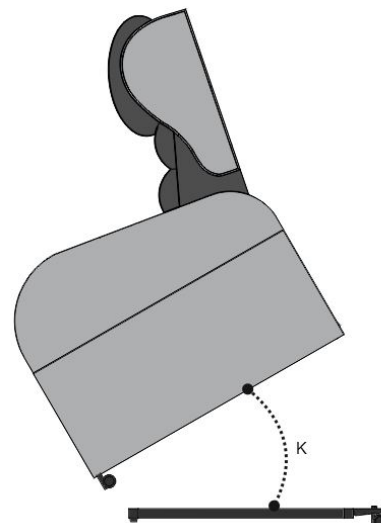
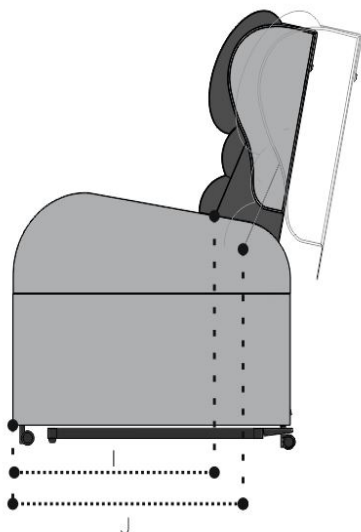

Infection Control

Infection prevention is vitally important in the home, hospital and healthcare environments. Bacteria and germs often contribute to the development and spread of infections. They can potentially be very harmful so this is important to control and prevent, especially in areas such as hospitals, where patients may be vulnerable and susceptible to infection.

Seating Matters take infection control very seriously. Our chairs have been specifically designed to decrease entrapment areas where bacteria and germs can survive.

Dartex Multi-stretch (Patient contact surface). Waterproof, stain resistant, flame retardant, multidirectional stretch for pressure redistribution i.e. seat cushion, calf panels, lateral supports and seat back.

BELOW ARE SOME OF THE STEPS WE HAVE TAKEN TO PREVENT THE SPREAD OF INFECTIONS:

- ✓ All chairs are upholstered in a hard-wearing, enduring contract vinyl proven to counteract C.difficile, E.coli as well as MRSA and the vast majority of bacteria.
- ✓ The materials can all be cleaned with hospital-grade cleaning agents, without causing damage to the fabrics. Please refer to the instructions on the specific cleaning solution you intend to use for best results.
- ✓ The seat cushion is removable for ease of cleaning.
- ✓ The seat cushion is attached to the base of the chair with a non-slip, wipeable material therefore having no materials such as Velcro which can hold dirt and bacteria.
- ✓ All electric components are part of a sealed unit which can be wiped clean.
- ✓ The metal frames of the chairs have a powder coated finish which is electro-statically applied then cured under heat to allow it to form a "skin". The powder is a thermoset polymer and is used to create a hard finish that is tougher than conventional paint, therefore protecting the frame from being exposed to outside conditions and thus preventing rusting.
- ✓ All chairs have modular parts which means the chair can be completely dismantled leaving no areas unexposed for cleaning.
- ✓ The complete chair frame is designed with flat panels throughout which can be easily wiped clean.
- ✓ Dartex Multi-stretch Fabric (Patient contact surface). Properties: This fabric is waterproof, has the ability to be wiped clean and has biostatic (anti-mycotic) coatings to provide an impenetrable barrier to virus and bacteria.



Build Quality

It takes continuous, careful planning to ensure our chairs are functional as well as being aesthetically pleasing. Our design team are adamant that the chairs need to be designed in such a way that they fit into a home environment. Each and every part of a Seating Matters chair has been engineered and devised to offer optimum quality and support for the user.



EASE OF USE

All Seating Matters chairs can be adjusted without tools in less than one minute. Useful to easily and efficiently adjust the chair to suit the user or to readjust for use within a multi-user environment.



7 YEAR WARRANTY

Have total peace of mind when relaxing in a Seating Matters chair as each one has passed some of the world's most stringent standards for strength, durability and safety. That's why we can uphold an industry leading 7 Year Frame warranty on the Phoenix chair with total confidence. Some terms and conditions apply, see our 7 Year Warranty booklet for full details.

10 101

About-us

Hello, I'm Martina Tierney,
I am an Occupational Therapist, Author, Educator and the Clinical Director of Seating Matters.

Throughout my 30 year career, I have worked in acute and community care, nursing homes and rehab, specializing in clinical seating provision. During my time working with patients, I discovered the profound effects poorly designed seating could have on patient outcomes and struggled to find chairs which met their clinical and functional needs.

After outlining the different features my patients required, including pressure care and easy adjustability, I set the goal to change the world of healthcare seating, by designing therapeutic chairs that would meet needs of bed-bound and low mobility patients.

WHY SEATING MATTERS

It is sometimes hard for an able-bodied person to understand what it feels like to be sitting for long periods of time and how this affects your life sitting in a poorly designed chair. An able-bodied person can easily and unconsciously re-adjust their position before getting too uncomfortable.

As a comparison, think of the discomfort when you are sitting on a long-haul flight. You will get up and walk around to reduce any pain. This shows that a standard chair is not suitable for long term sitting.

Now imagine doing a long-haul flight every single day of your life.
That is what some people experience every day in their own homes, hospitals or care facilities and many haven't got the ability to change their own position!

That is why getting the right chair for the right person is so important.

Even today, too many people continue to experience pain because of poor posture and poorly designed seating. Too many people are suffering a reduced quality of life from avoidable pressure injuries. Also far too much money is being spent by health services worldwide on reacting to these problems after it is too late.

Clinical, functional seating can help solve these problems.

As author of 'The Clinician's Seating Handbook' amongst other titles, I continue to research to find new solutions to seating challenges and help to educate audiences throughout the world on my findings.

Today, Seating Matters is changing the world through healthcare seating by improving the knowledge available to the healthcare community and by continually pushing the boundaries of seating innovations.

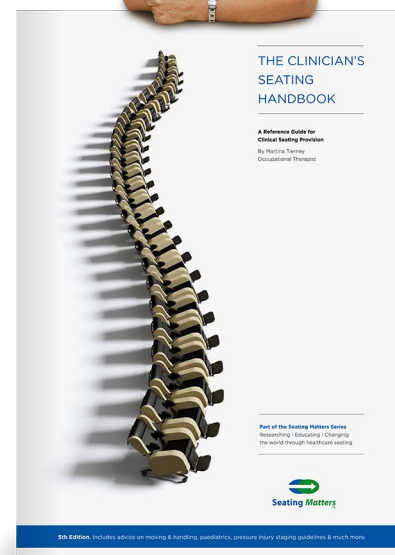

To request a copy of The Clinicians Seating Handbook visit:
www.seatingmatters.com.au

“Each day I realise more and more the impact of seating on people’s lives. For these people, the quality of their chair determines the quality of their life.”

— Martina Tierney, OT



Seating Matters
TM

Elite Healthcare Ltd.
Phone: +353 (0) 1 8903932
Fax: +353 (0) 1 8903937

Web: www.elitehealthcare.ie
Email: info@elitehealthcare.ie

Dublin: F1 Swords Enterprise Park,
Feltrim Road, Swords, Co Dublin,
K67 E984, Ireland.

Cork: 602 Harbour Point Business
Park, Little Island, Cork, T45 X624,
Ireland.