

COMPETITION GRADE HIGH PERFORMANCE RADIO CONTROL RACING CAR CHASSIS KIT

# WILDFIRE 006

DYNAMICS EDITION

WITH UPDATED VBC DYNAMICS PERFORMANCE PACKAGE

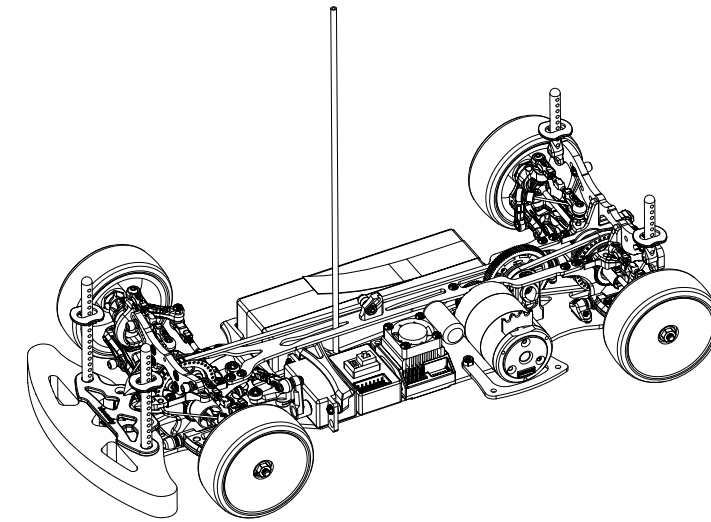

PACKAGE LIST



Thank you for purchasing VBC Racing product.

**Things that we should remind you.**

This VBC Racing kit is a high performance, racing grade car kit intended for experienced racers. The kit compose of VBC formulated composite materials, top quality full carbon fiber chassis and high grade 7075 material which will give you a competitive edge over the others.

Novice racer should seek advice from more experienced racer before assembly.

Always keep this instruction manual handy at all times for quick reference even after completing the assembly.

**Before your assembly, sand the chassis edges.**

Sand the chassis edges with #600 sand paper and apply CA glue to the edges and counter sink holes.

**Need help or support.**

If you need help or you would like to leave us a comment, please email to our support team: [support@vbc-racing.com](mailto:support@vbc-racing.com) or visit our web site [www.vbcrc.com](http://www.vbcrc.com)



BAG MARKED

# WILDFIRE D06 DYNAMICS EDITION



VBC Dynamics options included in the bag

**STEP 1**  
OPTION

WildFireD06 ALU7075 Chassis (2.0mm) B-02-VBC-3043 x 1  
Option Chassis for WildFireD06 Standard Graphite Chassis

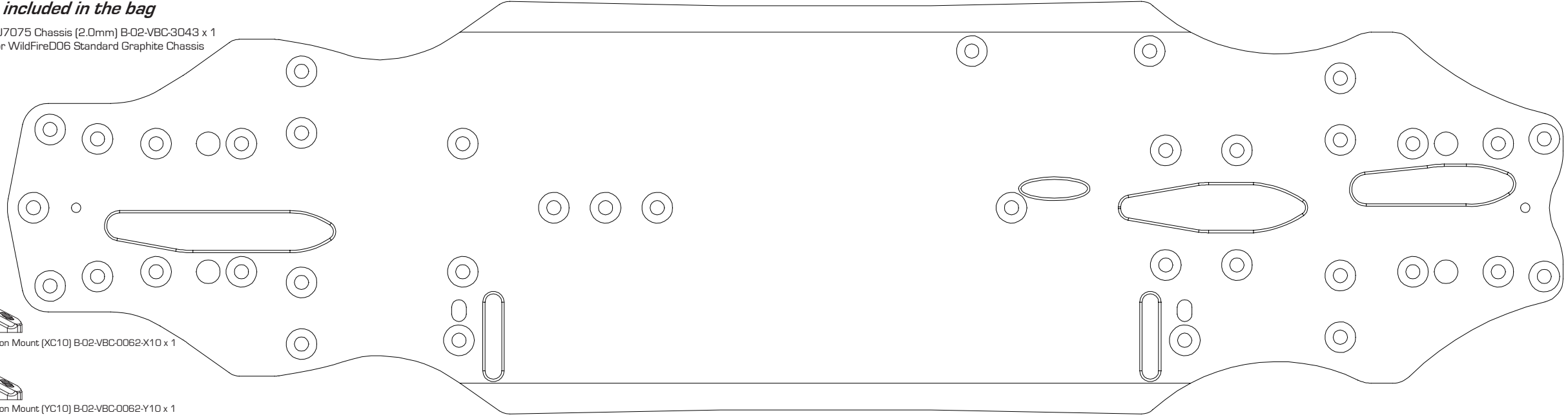

**STEP 4**  
OPTION



Center Suspension Mount (XC10) B-02-VBC-0062-X10 x 1



Center Suspension Mount (YC10) B-02-VBC-0062-Y10 x 1

**STEP 6**  
OPTION



Center Suspension Mount Shim(0.5mm) Option A-01-VBC-0042 x 2



Center Suspension Mount Shim(0.5mm) Option A-01-VBC-0042 x 2

**STEP 11**  
OPTION



Titanium Coated Center Shaft Pin B-02-VBC-0095 x 2

**STEP 14**  
OPTION

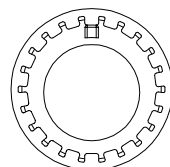

Belt Tension Adjuster Ring (Black) A-03-VBC-3048 x 2

**STEP 15**  
OPTION

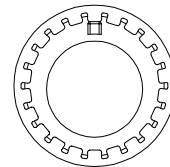

Belt Tension Adjuster Ring (Black) A-03-VBC-3048 x 2

**STEP 18**  
OPTION



E20 Suspension Mount B-02-VBC-0061-20 x 1

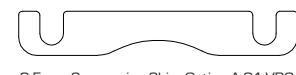

0.5mm Suspension Shim Option A-01-VBC-0041 x 1



Titanium Coated Suspension Arm Pin B-02-VBC-0098 x 2

**STEP 19**  
OPTION

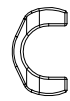

Shaft End Shoe (Self Lubricating) A-03-VBC-0077 x 2

**STEP 20**  
OPTION



Titanium Coated Upright Shaft B-02-VBC-0096 x 2

**STEP 21**  
OPTION

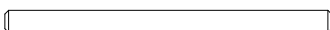

Titanium Coated Suspension Arm Pin B-02-VBC-0098 x 2

**STEP 22**  
OPTION

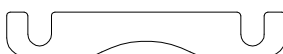

0.5mm Suspension Shim Option A-01-VBC-0041 x 1

**STEP 24**  
OPTION



Titanium Coated Upright Shaft B-02-VBC-0096 x 2

**STEP 25**  
OPTION



Front Stabilizer 1.4 White Option B-02-VBC-0074-14 x 1

Front Stabilizer 1.2 Green Option B-02-VBC-0074-12 x 1

Rear Stabilizer 1.4 White Option B-02-VBC-0075-14 x 1

Rear Stabilizer 1.2 Green Option B-02-VBC-0075-12 x 1

**STEP 28**  
OPTION

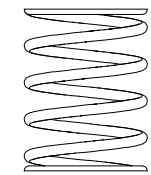

TBB Shock Spring (Green-Soft) B-02-VBC-0136 x 2

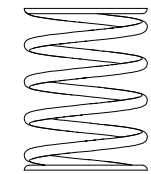

TBB Shock Spring (White-Hard) B-02-VBC-0137 x 2



TBB Oil Sealer Cap (Soft-Clear) B-03-VBC-0139 x 4



TBB Oil Sealer Cap (Medium Hard-Blue) B-03-VBC-0141 x 4



TBB Oil Sealer Cap (Hard-Pink) B-03-VBC-0142 x 4

**STEP 27**  
OPTION

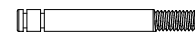

Titanium Coated Shock Shaft for TBB Shocks B-02-VBC-3031 x 4

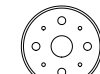

TBB Shock Piston (4 holes) A-03-VBC-0138 x 4

**STEP 34**  
OPTION

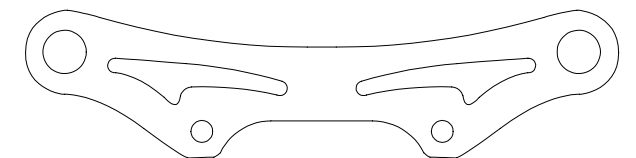

WildFireD06 ALU7075 Chassis (2.0mm) B-02-VBC-3043 x 1