

DS-88 6-Speed
Sequential Transmission

Sequential Transmission

-Installation Manual-

—INSTALLATION OF TRANSMISSION—

- ① This kit is designed to use originally equipped transfer unit. However, the bolts that connect the transmission case and the transfer unit may be longer than it should be in some cases. Cut the bolts to the ideal length if it is too long to be tightened.
- ② Screw a stud bolt that is enclosed in the kit to the place indicated by ○ in picture 1. Tighten it fully, and adjust the remaining length of the threads to be 27mm. Cut the stud bolt when necessary. Use the nuts enclosed in the kit when fitting transmission case.

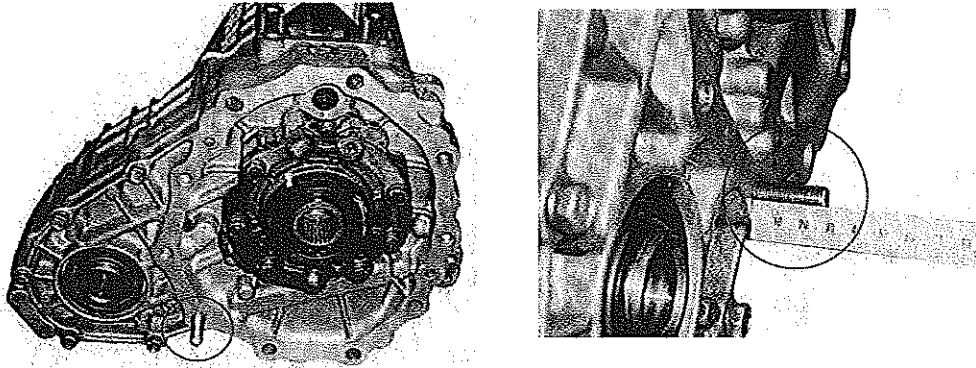

Picture 1

- ③ Before fitting flywheel to the engine, fit the transmission case and check if the case will not touch any part of the floor.

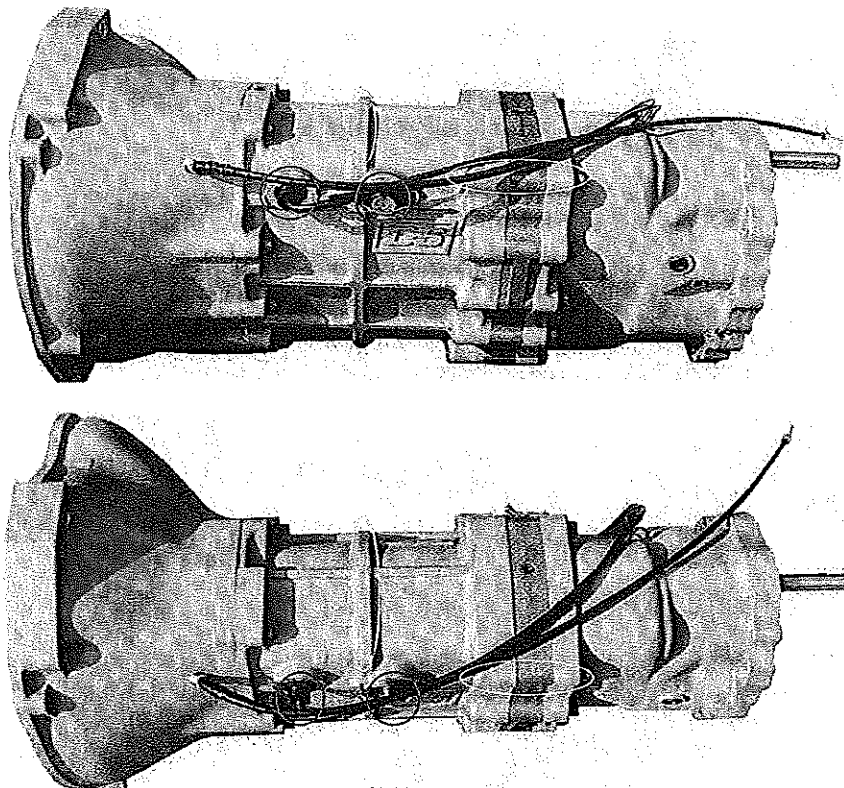

Although it depends on model years, the places shown in ○ in picture 2 is most likely to touch the floor. Also the part indicated by ○ may touch the floor. If it does, fix the part of the floor to fit the case.

Picture 2

- ④ Check the length of release sleeve before installing the transmission case. The length may differ by the clutch system. Use OS made release sleeve that is designed for OS-88.

※Refer to the instruction given in installation manual of OS clutch kit.

※Always use OS clutch system for OS-88. The shape of the input shaft is different from the originally equipped transmission. We do not have any information or data of any clutch system by the other manufacturers. We do not take any responsibilities for an loss and/or injury that result from the use of improper clutch system.

- ⑤ Fit a dust cover with M6 × 15 hex head cap screws as shown in the picture. Tighten the screw though a part of the dust cover may slightly touch the bell housing.



- ⑥ OEM transmission cross member can be used, however, the transmission will be mounted 40mm lower than the original. Prepare spacers of some kind for the cross member to be fit in proper place. We recommend using OS made cross member as an optional, to increase the clearance between the floor and the road surface.

※Please be aware that the OEM cross member can be dangerous as it may touch road surface, causing fatal injury and/or serious damage to the vehicle.

- ⑦ Oil capacity is 2.1 to 2.3 liter. Be patient when filling the oil, as it may overflow when filled at once. Do not overfill.

Using street:75W-140 Grade oil

Using circuit-run, drag-race:75W-250 Grade oil

-Warning when attaching the oil cooler-

If attaching the oil cooler be careful of the oil amount, and whilst driving the oil pump must operating to circulate the oil. If the oil pump is not in use, the oil to spray out of the breather.

If the oil sprays out of the breather even when the oil pump is operating, then this means there is too much oil, so make adjustments like reducing the amount of oil.

• CLUTCH

If you already have our OS made clutch systems : TS2CD, TS3B, R3C and R4C, OS-88 can be installed with these clutch system by using the following additional parts.

- TS2CD/TS3B : Replace clutch disks with the ones exclusively designed for OS-88.
- R3C/R4C : Replace the center hub plate with the one that exclusively designed for OS-88.

※If it is an older R3C/R4C clutch system (older model has No.1 disk bolted on the center hub plate), replace No.1 disk and pressure plate as well.

Always use the correct release sleeve as instructed in installation manual of OS clutch system.

• RELEASE CYLINDERS

OS-88 is designed to use a push-type release cylinder. For the models with pull-type release cylinder, BNR32s ('93-on after minor-changed models) and BCNR33s, use push-type release cylinder of earlier BNR32s.

• RELEASE FORK

For minor-changed BNR32s and BCNR33s, use release fork of earlier BNR32. We offer adjustable fork kit as an optional parts.

-Genuine NISSAN parts number-

- BNR32 (Before minor change) release cylinder : 30620-21U01
- BNR32 (Before minor change) release fork : 30531-01S00
- Pivot spring : 30534-E9000
- Sleeve spring : 30514-14600

※Parts number may change without any notice. Please consult your NISSAN dealer for further information.

WARNING !

Transmission is a "wearable". When it becomes stiff to operate, or faulty engagement occurs, overhauling may be needed. Please consult us before overhauling the OS-88 transmission system, as overhauling of the system requires special tools and professional knowledge of the product. We offer overhauling service for OS-88 by a team of transmission specialists. Do not make any modification to the product.

-INSTALLING THE KIT FOR BNR34-

• TRANSFER

- ① Use the transfer unit of BCNR33.
- ② Remove speedmeter drive gear from the transfer of BNR34. This gear is to be used with transfer of BCNR33. It should be fit without any modification.
- ③ There should be a space of about 25mm between propeller shaft and transfer case. You will need to prepare a spacer of some kind to fill this space. This spacer won't be needed when propeller shaft of BCNR33 (front half from center joint) is used.

• CLUTCH

If you already have OS BNR34 Clutch system installed, replace center hub and release sleeve to fit OS-88.

※ Older type center hub that the No.1 disk is bolted, must be replace newer type No.1 disk and pressure plate.

Use OS Release sleeve that is designed for OS-88.

• RELEASE CYLINDER

OS-88 is designed to use push-type release cylinder. Use push-type release cylinder of earlier BNR32 (before minor changed models), as BNR34 uses pull-type release cylinder.

• RELEASE FORK

For BNR32 ('93-on after minor changed models) and BCNR33, use the release fork of earlier BNR32 or OS Adjustable Fork Kit.

-Nissan Genuine Parts Number-

- BNR32 (Before minor change) release cylinder : 30620-21U01
- BNR32 (Before minor change) release fork : 30531-01S00
- Pivot spring : 30534-E9000
- Sleeve spring : 30514-14600
- BCNR33 transfer unit : 33100-23U00
- BCNR33 propeller shaft, rear : 37300-24U00

※ Parts number may change without any notice. Please consult your NISSAN dealer for further information.

• INDICATOR KIT

Make sure every connection is correct and tight. Indicator should be installed in visible position where it does not obstruct driving view. Also, make sure that the wires do not touch any moving part. Keep the main control unit away from the heat. Bundle and organize the wires so that it will not obstruct driving.

- WIRE of MAIN CONTROL UNIT
Red(with fuse) → (+)ignition
Black → (-)ground

• Connection of reversing light and neutral switch

Connect wires of the indicator kit to the wires that were originally connected to the OEM transmission. The kit has 3 wires in different colors (red, black and white). See below.

Ex. Model : Wire color of the vehicle/Wire color of the kit

BNR32:

Reversing light
Green-Red Green/White-Black

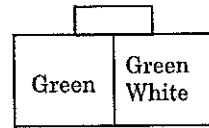

Neutral Switch
Green/Orange-White Black-not connected

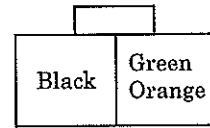

BCNR33:

Reversing light
Red-Red Green/Red-Black
or
Red-Red Blue-Black

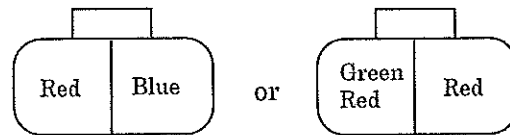

Neutral switch
Green/Orange-White Black-not connected

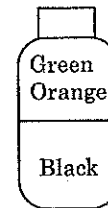

BNR34:

Reversing light
Green-Red Green/Yellow-Black

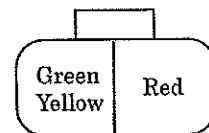

Neutral switch
Yellow/Red-White Black-not connected

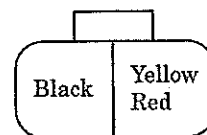

※The color of the wires of vehicle may vary by model year.

-SHIFT LEVER INSTALLMENT-

- ① Remove the original shift lever bushing (NISSAN original part number : 32861-05U00) ; and put it to the shift lever enclosed in the kit. Then fit the shift lever to the transmission. Please be noticed that the enclosed spacer has directions. The rounded side should be placed down.

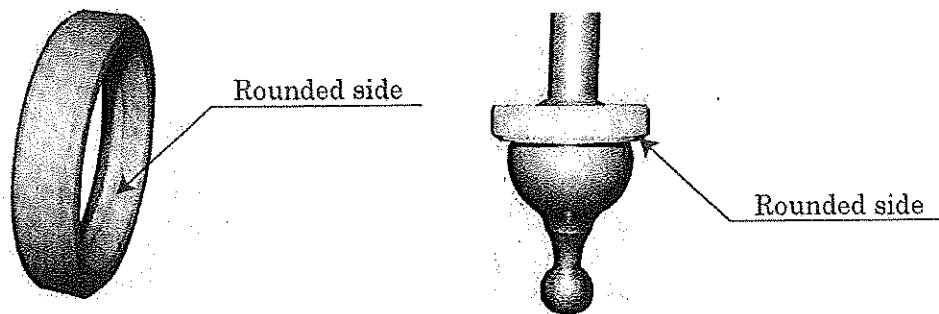

- ② Set wire outer stopper first, and then position lock lever, shift knob.

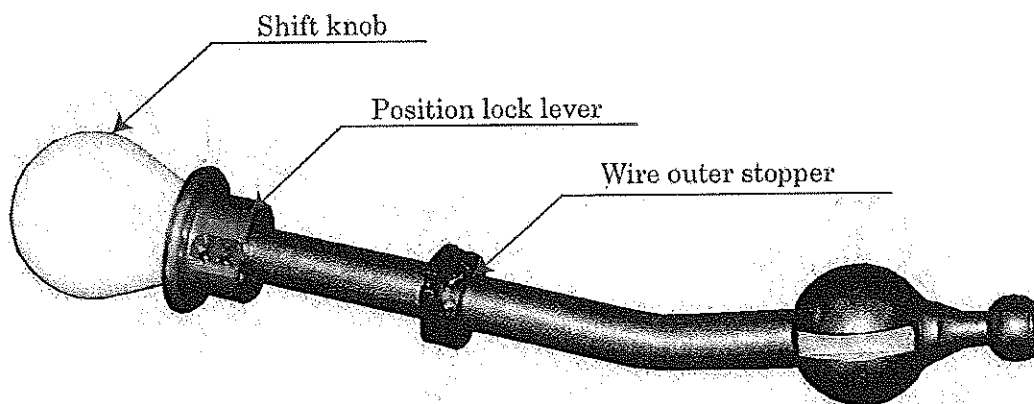

- ③ Set the wire outer to the stopper. Cut the wire inner to an appropriate length.

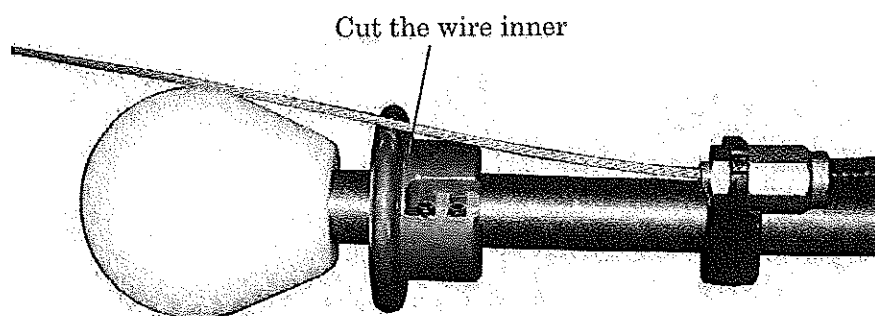

- ④Put the wire inner through the position lock lever, and then fix it. Set the wire outer stopper to the place so that there are 15mm gap between the shift knob and the position lock lever.

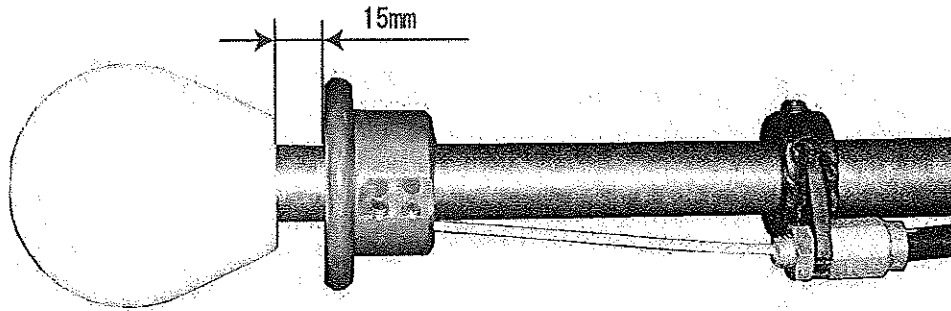

※The measurement given above (15mm) is a yardstick. If the position lock remains locked, adjust the wire outer stopper. Do not pull the wire with excessive force, as it may break the wire inner.

—OPERATION—

This product is a sequential transmission. Please read the below carefully, otherwise serious injury and/or major damage to the vehicle may occur.

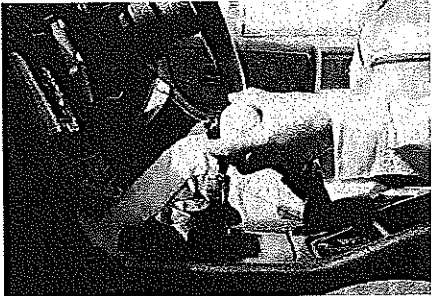

Picture 3

When select gear from Neutral(N) to Reverse(R), or from (R) to (N), the shift lever should be locked. As in picture 3, pull the position lock lever to shift from (N) to (R) or from (R) to (N).



Picture 4

①Reverse(R)

As shown in picture 4, shift the gear forward while pulling the position lock lever. If the gear feels stiff, try half-clutch or select Neutral, then select Reverse again. Do not try to shift Reverse with excessive force.

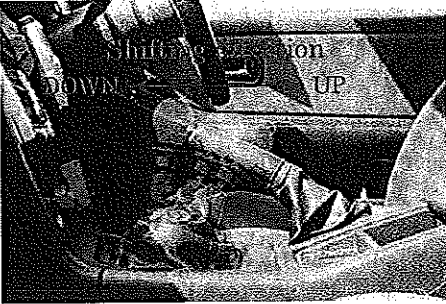

Picture 5

②Neutral to Sixth

It is not necessary to pull the position lock when shifting N→①→②→③→④→⑤→⑥th gear.

Pulling the lever backward shifts the gear up, and pushing the lever shifts the gear down, sequentially. See picture 5.

※Clutch Operation

Although this transmission allows driver to shift gears without letting out the clutch, using clutch properly reduces the load imposed on the transmission and helps to improve durability. We recommend using clutch when shifting a gear.

OPERATION

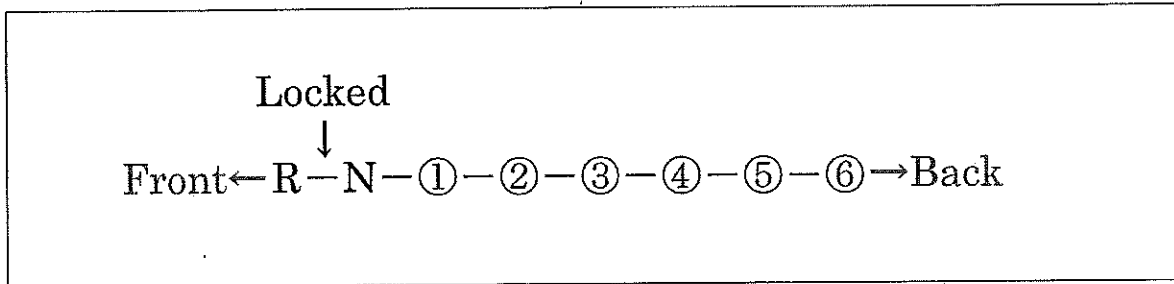

-Racing Clutch for OS-88-

- TS2CD

Ideal for moderate tuned engine. Pressed steel cover, spring hub dumper, twin plate clutch system.

Pressure of cover : 1000kgf/m
Disk size : ϕ 215mm
Maximum power capacity : 600ps

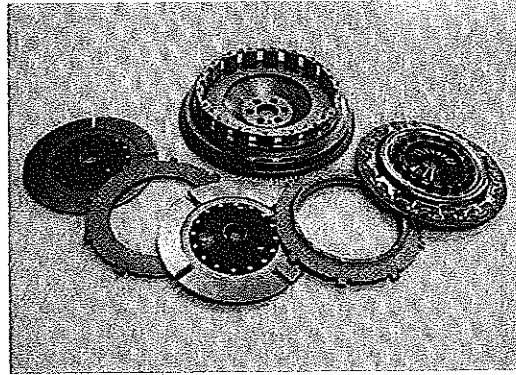

- TS3B

A standard triple plate clutch system of OS Giken. Pressed steel cover, smaller disk diameter for better engine response.

Pressure of cover : 1000kgf/m
Disk size : ϕ 204mm
Maximum power capacity : 700ps

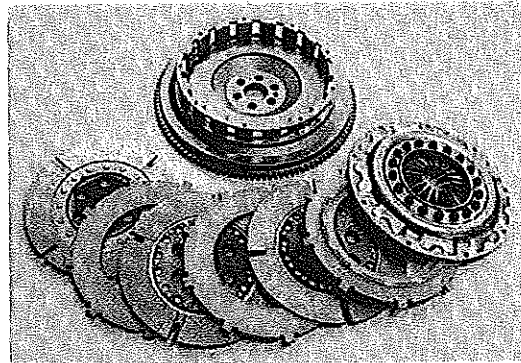

- R3C

Center hub plate type triple system with billet aluminum clutch cover. One of the highest grade model of OS clutch products. Ideal for race and drag racing use.

Pressure of cover : 1100kgf/m
disk size : ϕ 215mm
Maximum power capacity : 1200ps

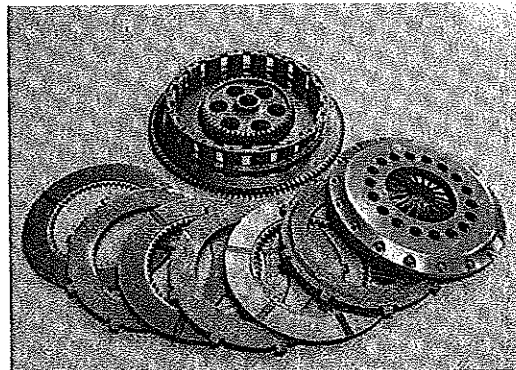

- R4C

Top of the line. Its quadruple plate system offers the highest power capacity for any hard-tuned power unit.

Pressure of cover : 1100kgf/m
Disk size : ϕ 215mm
Maximum power capacity : 1500ps

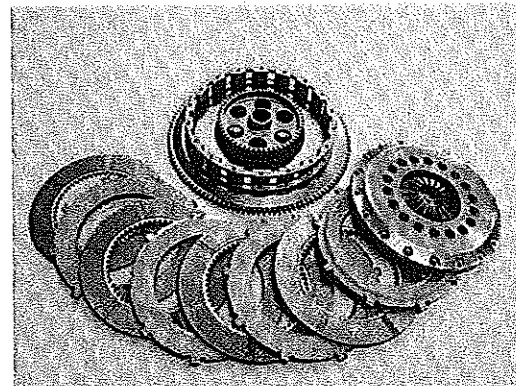

-Optional Parts-

- ADJUSTABLE RELEASE FORK KIT

Compulsory set the release fork back at the position by spring.
Adjustable push rod enables to set the release fork to desirable position.

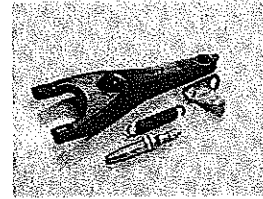

- RELEASE SLEEVE BEARING SET

We provide various release sleeve bearings in different thickness for various clutch system.

BNR32/BCNR33 TS2CD : 12mm
TS3B : 16mm
R3C : 28mm
R4C : 18mm

BNR34 R3C : 22mm
R4C : 12mm

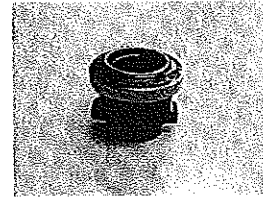

- CENTER ALIGNMENT TOOL

A special tool to align center of clutch disks. Designed for OS-88 spline.

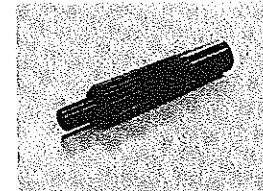

- TRANSMISSION CROSS MEMBER for OS-88

A mission member designed for OS-88, which provides better road clearance.

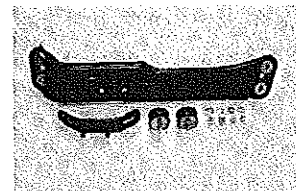

※The transmission will be mounted 40mm lower than the original if you use Nissan OEM transmission cross member.

- HEAVY WEIGHT SHIFT KNOB

A chrome-plated brass shift knob.



-OPTIONAL PARTS-

- Direct Shift Kit

Where the connecting areas would be plastic when standard, by changing these sections to brass a more solid and clear feeling is achieved when shifting gear.

The shift lever is also connected directly to the transmission, without a plastic bush.

There is also a straight type for the shift lever.

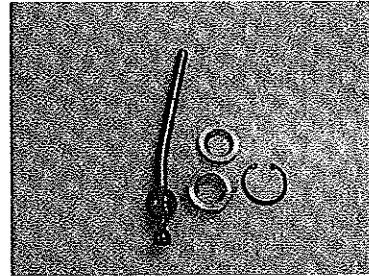

- Direct Shift Lever

Between the standard shift lever and the transmission, there is a plastic bush which makes shifting gear lack directness. Therefore, by connecting the shift lever without the plastic bush a solid direct feeling is achieved when shifting gear.

There are two types available, the normal type and the straight type.

