

Frizzlife®

OWNER'S MANUAL

Model: MV99-B

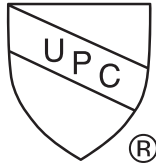

Certified by IAPMO R&T according to NSF/ANSI 42 & 53 for material safety, Structural Integrity, Chlorine, Particulate Class I, Lead and Cyst remove.



CONTENT

1. BEFORE INSTALLATION	1
2.PRODUCT INTRODUCTION	2
3.SAMPLE CONNECTION	2
4.INSTALLATION TIPS	3
5.INSTALLATION STEPS	3
6.REPLACEMENT OF FILTER CARTRIDGE	6
7.FILTER REPLACEMENT INSTRUCTION	6
8.MAINTENANCE	7
9.LIMITED PRODUCT WARRANTY	7

Thank you for purchasing Frizzlife MV99 RV water filter system.
If you have any questions or need any assistance, please contact:
support@frizzlife.com

Find the installation video

Search 'Frizzlife MV99 Installation' on
www.YouTube.com

Register to get 150% warranty

1. Email us your order ID and full name at
support@frizzlife.com.
2. Scan the QR code to register.



1. Before installation

• Inspect box

Open the box and take out the system and all the components. Inspect them carefully according to 'Product Introduction' and make sure nothing is missing or damaged during shipping. If any parts are cracked or broken, please do not proceed with the installation and contact Frizzlife for an exchange or diagnosis.

• Technocal Parameters

Model	MV99-B	Feed Water Pressure	20-80psi
Flow Rate	1.5 GPM	Feed Water Temperature	Min.41°F, Max.122°F
Capacity	800 Gallon	Applicable Water Source	Municipal water
Micron Rating	0.5 micron	Replacement Filter Model	FZ-2

Rated Flow above is 1.5gallons/m @ 77°F. Low water temperature will slow down water flow. Please contact us for reference at:
support@frizzlife.com

2. Product Introduction

The brief introduction of components and sample connection are presented as follows. Please identify and get familiar with components and connection point for a smooth installation.

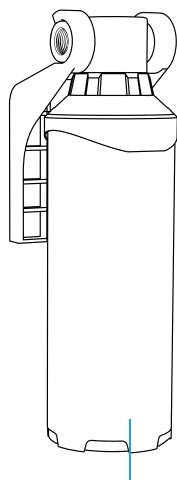

Water Filter System

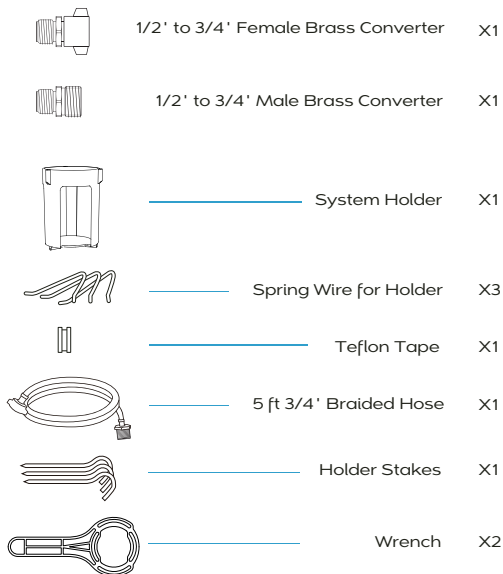

3. Sample Connection

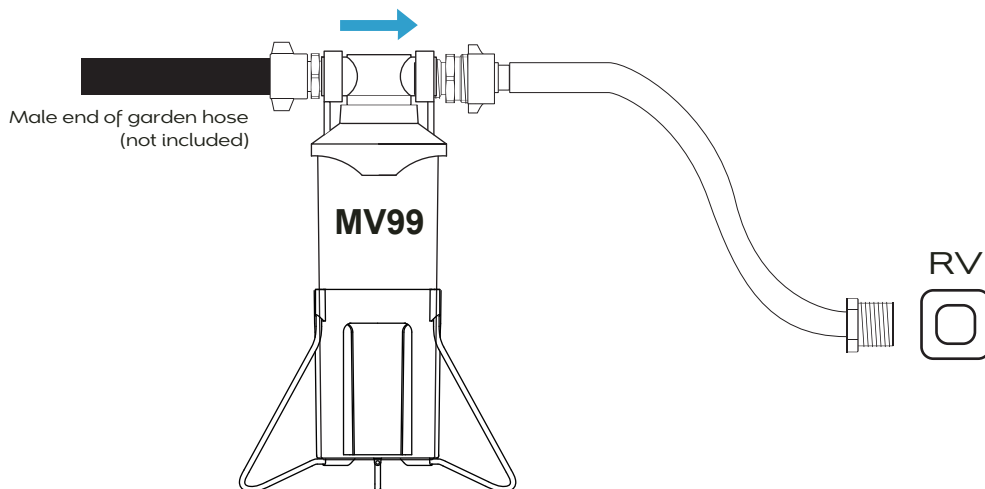

4. Installation Tips

1. Make sure every component of the system is connected with each other firmly.
2. Use teflon tape if necessary to prevent leakage.
3. The filter is recommended to be set upright for optimum filtration performance. The holder of the system is optional for installation.
4. Please kindly note the package does not include garden hose and flexible hose protector.

5. Installation Steps

Precautions:

1. Do not use with water that is microbiologically unsafe or of unknown quality without adequate disinfection.
2. Testing was performed under standard laboratory conditions, actual performance may vary.
3. For cold water use only.
4. This filter must be protected from freezing, which can cause cracking of the filter and water leakage.
5. Do not allow children under 3 years of age to have access to small parts during installation.
6. The installation must comply with all applicable state and local regulations.

Step 1: Unpack the system and setup the holder for MV99

Setup the holder on flat ground.

Insert the long side end of the wire into the upper hole of the holder. Insert the other end into the base hole.

Make sure all three spring wires of the holder have been stretched out steadily.



Step 2: Use the Metal pegs if necessary (Optional)

Hook up the metal pegs to the holder.
Drive the stakes into the ground and make sure the holder is setup firmly.

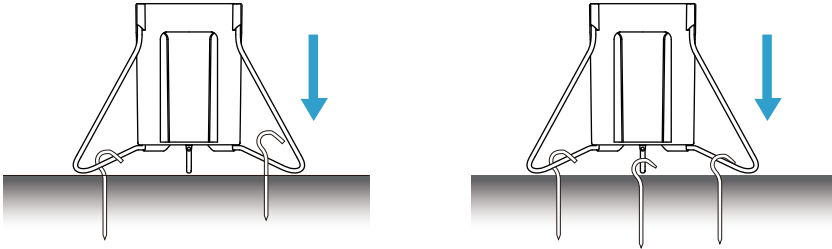

Step 3: Set MV99 filter system on the holder.

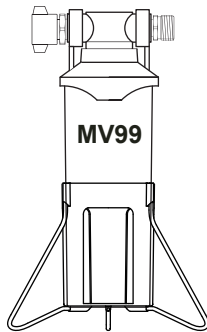

Step 4: Connect your garden hose(not included) to water source

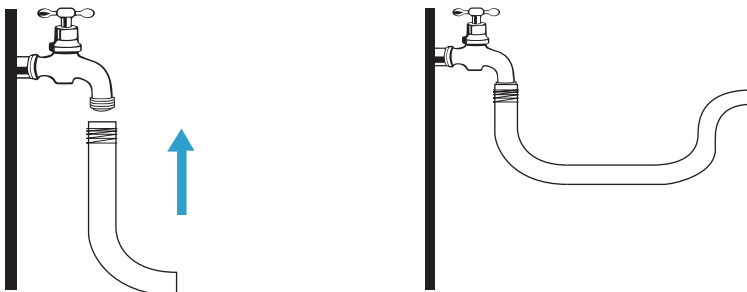

Step 5: Connect the filter system with water hoses

Connect the other end of your garden hose (not included) to the "Supply" side.

Connect the female end of provided 3/4" braided water hose to the 'Filtered' side.

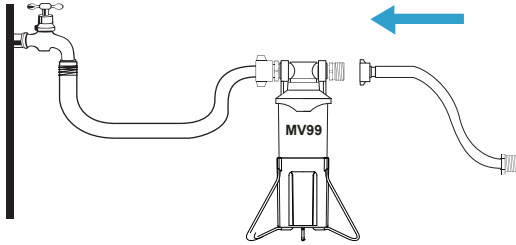

Step 6: Flush the filter

Allow water to flush filter for 5-10 minutes to remove carbon fines before use. (It is normal if you observe black particles in the water for the first time flush.)

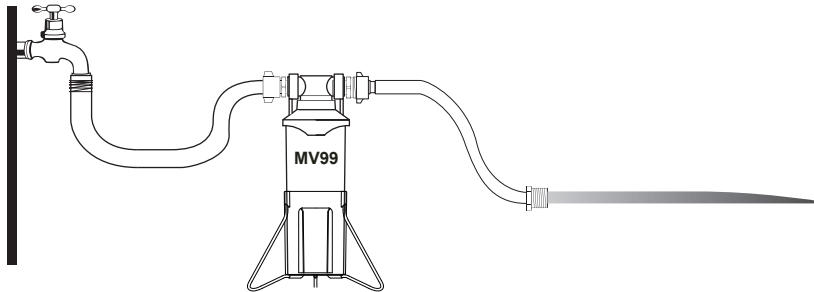

Step 7: Connect the RV

Connect male end of provided water hose to RV.

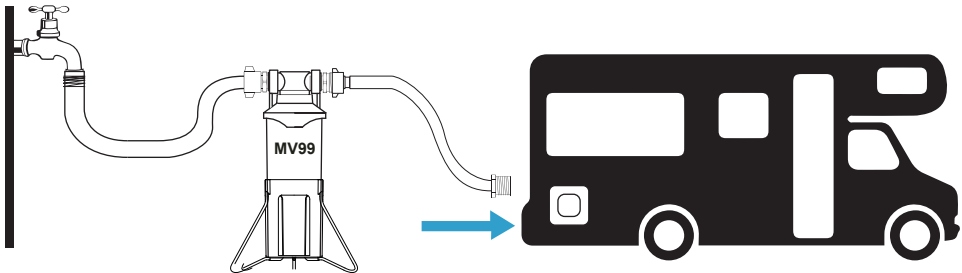

Step 8: Check for leaks and mark the date of first use

Turn on the water supply and check for leaks.

Write date of first use on filter. *Average filter life: 8-12 months

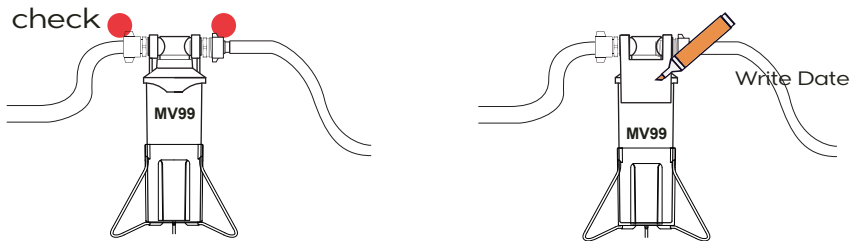

6.Replacement of Filter Cartridge

Filter	Model Number	Recommended Replacement Period
2-in-1 Composite Filter	FZ-2	6-8 months

NOTE:

All the service life of the filter cartridge listed are based on actual laboratory test with the provided water. The actual service life of filter cartridge depends on source water quality and daily water usage.

7.Replacement Instruction:

You don't need to cut off the water supply, since the system adopts auto shut off design.

Twist the housing counter clockwise and use a wrench to unscrew the housing body. Use the wrench to unscrew the housing body. Take out the old cartridge and load with the new one, then install back in the same way. Please flush the new cartridge for 5-10 minutes before starting to use.

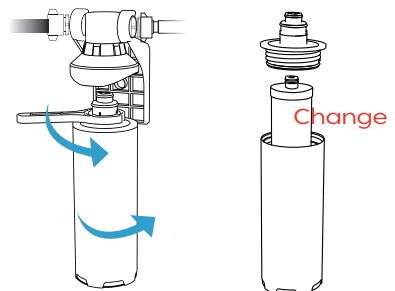

8.Maintenance

- Do not use with water that is microbiologically unsafe or of unknown quality without adequate disinfection.
- Please replace the filter cartridges regularly to ensure optimal filtration performance.
- The testing was performed under standard laboratory conditions, actual performance may vary depending on the source water quality and water usage. In case of premature blockage and failure of the filters, it is recommended to replace the filter in accordance with actual usage.
- Check the system and water pipe fittings regularly for water leakage to avoid any property damage.

9. Limited Product Warranty

MV99 RV Water Filter System | Warrantor: FRIZZLIFE INC

TWO YEAR LIMITED FRIZZLIFE WARRANTY

The Frizzlife MV99 RV Water Filter Systems are warranted to the original purchaser.

To be free of defects in material and workmanship by Frizzlife INC, Frizzlife will replace or repair components of the unit that Frizzlife has deemed to be broken within the limits of the warranty without charge. The customer is not responsible for any freight involved with shipping the item back for inspection and shipment of replacement items. Frizzlife is not liable for cost of removal, installation, transportation or any other charges in connection with a warranty claim.

1. Frizzlife is not liable for anything that we deem as abuse of the units, including but not limited to, misuse of product outside of intended use, equipment modifications, unauthorized repairs, improper installation, damage from freezing, hot water, fire or other acts of God outside of Frizzlife control. This warranty will be void if defects occur due to failure to observe the following conditions:

- Incoming water to the the system cannot exceed 100° F.
- Do not use outdoors or in a location that is subjected to direct sunlight or freezing.

This warranty will not be effective unless and until the Frizzlife is shown to have been used in accordance with the installation and maintenance instructions accompanying the product.

- The filter cartridges should be replaced in time according to the recommended replacement period.
- The plastic housings should be replaced every 18 months.

2. Filter Cartridges are considered as disposable items , thus are not covered by warranty.
3. Customer is responsible for proper operation, which includes complete and continual leak inspection.

Most of the unit components are made of plastic and eventually can break or crack from stress.

Frizzlife cannot be held liable for any damage caused by leaks.

There are no other warranties which extend beyond what is described above.

To receive warranty service, please contact Frizzlife at support@frizzlife.com

150% Extended Warranty

1. Email us your order ID and full name at support@frizzlife.com.
2. Scan the QR code below to register

