

MONTANATM
B R A N D



**AMERICAN
MADE**



Pro-Grade Power Tool Accessories



Pride of American-Made

Rocky Mountain Twist (RMT)/Montana Brand Tools (MBT) is the leading U.S. manufacturer of high-performance, precision industrial cutting tools and power tool accessories.

Founded in 2001, RMT/MBT headquarters and our 300,000 square foot facility is located at the base of the Rocky Mountains in Ronan, Montana, a region known for great hunting, fly-fishing and now superior quality cutting tools.



Perfecting the Technology

Utilizing innovative, advanced manufacturing technology is a universal rule at RMT/MB.

Proprietary state-of-the-art CNC drill grinding cells transform high-speed steel blanks into finished cutting tools without reorientation. This systematic process ensures exact specifications and superior quality that meets or exceeds National Aerospace Standards.

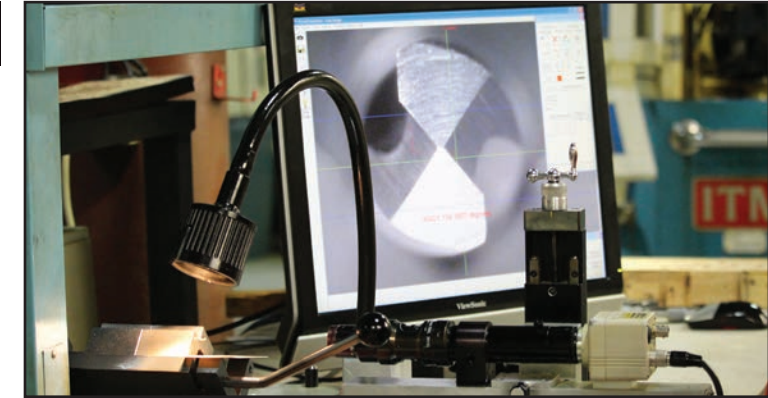

Innovation For The Future

RMT/MBT continues to expand its product offerings; developing innovative manufacturing methods utilizing proprietary processes and automation.

We are steadfast in manufacturing high-performance power tool accessories in Ronan, Montana, USA. Striving to keep the spirit of "American Made" alive and strong.



Proprietary CNC Drill Grinding Cell

Ultimate Partnership-Saving Time and Money

RMT/MBT prides itself on being more than just a supplier, we're a principle to foster collaborative customer partnerships by:

- assisting with engineering support and product solutions
- delivering exceptional product quality and service
- improving manufacturing efficiencies and processes
- providing outstanding customer service

Limited Lifetime Warranty

We warrant every Montana Brand tool to be free of defects in material and workmanship for life. Normal wear and tear or damage caused by abuse, misuse or alteration are not covered.

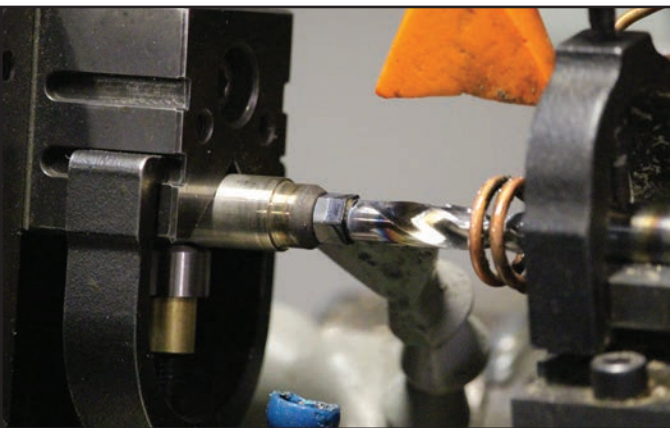

34837 Innovation Dr. • Ronan, MT 59864

(406) 528-4350 • www.MontanaBrandTools.com



DIAMOND TILE DRILL BITS

EXCEPTIONAL PERFORMANCE ON A RANGE OF APPLICATIONS.

FEATURES & BENEFITS:

- 10X Faster than standard glass and tile drill bits
- 15X Longer Life than standard carbide tip spade drill bits
- 40+ Holes drilled per drill bit based on tests drilling in ceramic tile with water coolant
- Heat-treated high-alloy steel
- Durable, self-sharpening diamond cutting edge
- Heavy-duty single piece construction
- Black oxide finish prevents corrosion and increases performance
- Ideal for drilling in ceramic, porcelain, granite, marble, stone, slate, and glass

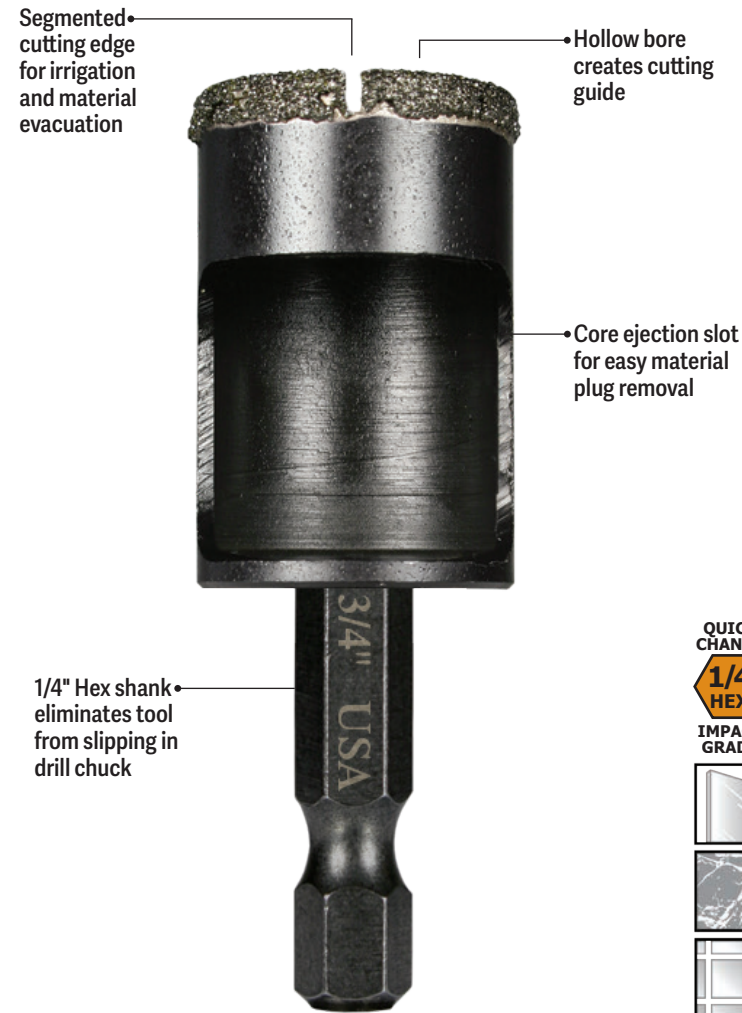

SIZE	PART NUMBER	ORDER MULTIPLES
3/16"	MB-65200	5
1/4"	MB-65201	5
5/16"	MB-65202	5
3/8"	MB-65203	5
1/2"	MB-65204	5
5/8"	MB-65205	5
3/4"	MB-65206	5
1"	MB-65207	5
1-3/8"	MB-65208	5
1-1/4"	MB-65199	5
3/16", 1/4", 1/2"	MB-65230 3pc Diamond Drill Set	5

AUTO-GUIDE™ ARBOR & HOLE SAWS

EXCEPTIONAL PERFORMANCE ON A RANGE OF APPLICATIONS.

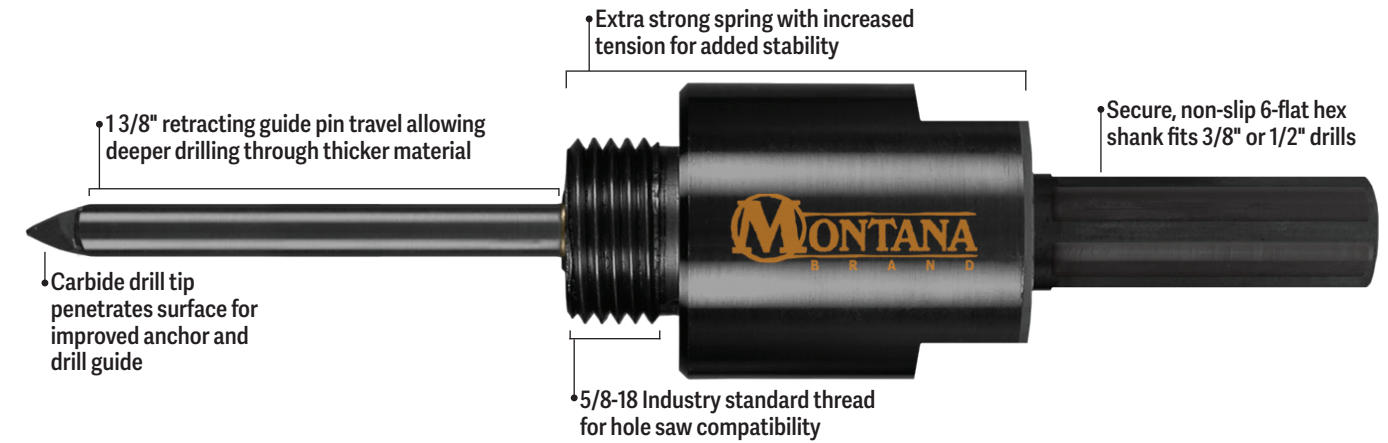

AUTO-GUIDE™ ARBOR FEATURES & BENEFITS:

- One-step operation
- Heavy-duty one-piece construction
- Carbide tip Auto-Guide™ anchor pin penetrates material to prevent surface "skating"
- Eliminates pilot drilling
- Improved strength, durability and extended life
- Deeper hole drilling and through thicker material
- Compatible with all industry standard hole saws



PART NUMBER	DESCRIPTION	ORDER MULTIPLES
MB-65213	Auto Guide™ Hole Saw Arbor	5
MB-65214	1" Diamond Hole Saw	5
MB-65209	1-1/4" Diamond Hole Saw	5
MB-65210	1-3/8" Diamond Hole Saw	5
MB-65215	1-1/2" Diamond Hole Saw	5
MB-65216	1-3/4" Diamond Hole Saw	5
MB-65211	2" Diamond Hole Saw	5
MB-65217	2-1/2" Diamond Hole Saw	5



DIAMOND HOLE SAW FEATURES & BENEFITS:

- Fast smooth cutting and long life
- Offset plug ejection slots for greater leverage, removing plugs fast
- Tough brazed diamond grit for long life, and thin kerf segmented edge for fast, smooth cutting
- Ideal for drilling in ceramic, porcelain, granite, marble, stone, slate, and glass



Comparative Testing



Material: 1/2" granite slab
Hole Size: 5/8"
Power Tool: 18v power drill

1) Drill Style: Standard/Spade
Drill Time: 2 minutes 30 seconds
Hole: Incomplete

2) Drill Style: Diamond Drill Bit
Drill Time: 45 Seconds
Hole: Complete

Revolutionary Innovation



UP TO 40 PLUS HOLES PER BIT
Based on tests drilling in ceramic tile with water coolant

SXT TITANIUM COATED DRILL BITS

WOOD, METAL, PLASTIC... NO PROBLEM.

Hex Shank

SIZE	PART NUMBER	ORDER MULTIPLES
1/16"	MB-64601	5
5/64"	MB-64602	5
3/32"	MB-64603	5
7/64"	MB-64604	5
1/8"	MB-64605	5
9/64"	MB-64606	5
5/32"	MB-64607	5
11/64"	MB-64608	5
3/16"	MB-64609	5
13/64"	MB-64610	5
7/32"	MB-64611	5
15/64"	MB-64612	5
1/4"	MB-64613	5
5/16"	MB-64617	5
3/8"	MB-64621	5
7/16"	MB-64625	5
1/2"	MB-64629	5
1/16", 3/32", 1/8", 1/4"	MB-64330 4pc Titanium Set	5
1/16" - 1/4"	MB-64340 14pc Titanium Set	5



FEATURES & BENEFITS:

- Hard surface with high lubricity extends tool life
- Extended life reduces cost per hole
- Drills clean accurate holes in wood, plastics, aluminum, copper, steel (low & medium carbon), stainless steel, strength alloys.
- Titanium coating reduces friction and increases drilling speeds in metal

QUICK CHANGE Drill and Drive System

IMPACT GRADE Quick Change Hex

Designed for standard and impact drill/drivers and compatible with our Quick Change Connector

1/4" Hex Shank-Eliminates tool from slipping in drill chuck

Die cast zinc hex creates a strong unified bond to withstand high torque applications



Round Shank

SIZE	PART NUMBER	ORDER MULTIPLES
1/16"	MB-64501	5
5/64"	MB-64502	5
3/32"	MB-64503	5
7/64"	MB-64504	5
1/8"	MB-64505	5
9/64"	MB-64506	5
5/32"	MB-64507	5
11/64"	MB-64508	5
3/16"	MB-64509	5
13/64"	MB-64510	5
7/32"	MB-64511	5
15/64"	MB-64512	5
1/4"	MB-64513	5
5/16"	MB-64517	5
3/8"	MB-64521	5
7/16"	MB-64525	5
1/2"	MB-64529	5
1/16", 5/64", 3/32", 7/64", 1/8", 5/32", 3/16"	MB-64550 7pc Titanium Set	5

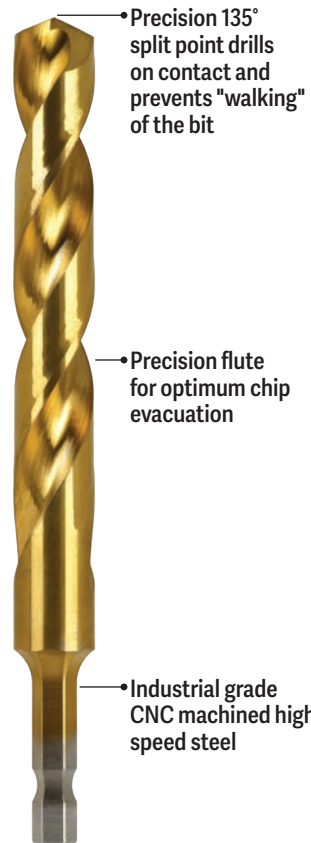

Precision 135° split point drills on contact and prevents "walking" of the bit

Precision flute for optimum chip evacuation

Industrial grade CNC machined high speed steel

Concentric from tip to shank for hole accuracy

Reduced shank (sizes above 3/8")



X29 BRAD POINT DRILL BITS

FASTER. CLEANER. LONGER LIFE

FEATURES & BENEFITS:

- Industry leading speed that reduces cycle times
- Truer, accurate hole diameter
- Unrivaled hole quality from entry to exit
- Generates minimal heat and material burn
- High heat dissipation for extended tool life
- Tri-flat shank for maximum drill chuck grip and prevents bit spin-out (3/16" and larger)

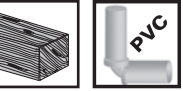
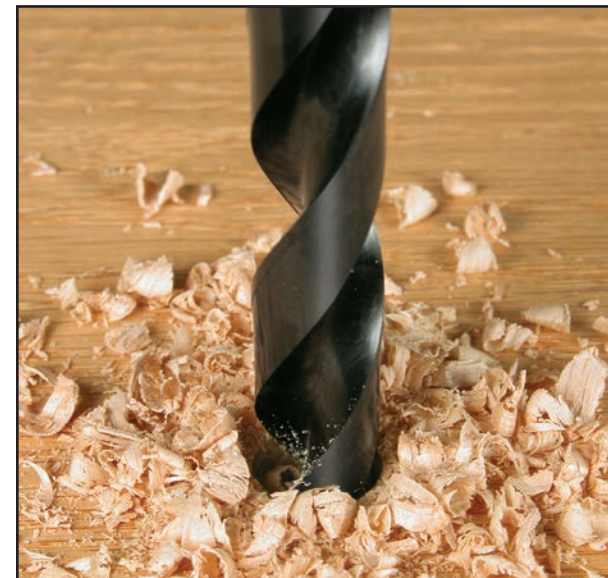

U.S. PATENT NO. D585919

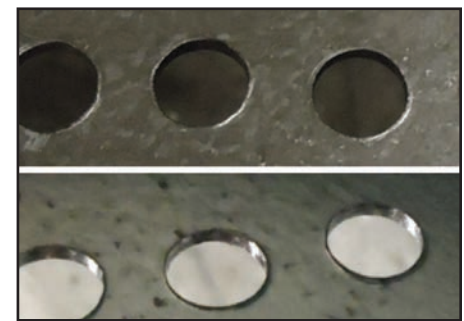

Brad points are perfect for drilling in wood and sheet metal but are also a great choice for drilling in a broad range of plastics including acrylic and plexiglass. *20 gauge maximum

Task specific flute geometry for optimal chip evacuation

Dihedral point geometry engineered to drill fast and clean



Tri-flat shank for maximum drill chuck grip and prevents bit spin-out

Concentric from tip to shank for precise hole accuracy

SIZE	PART NUMBER	ORDER MULTIPLES
1/8"	MB-64705	5
3/16"	MB-64709	5
1/4"	MB-64713	5
5/16"	MB-64717	5
3/8"	MB-64721	5
1/2"	MB-64729	5
1/8", 3/16", 1/4", 5/16", 3/8", 1/2"	MB-64760 6pc Brad Point Drill Bit Set	5



4-IN-1 MODULAR DRILL & DRIVER

FOUR FUNCTIONS. ONE GREAT ACCESSORY.

FEATURES & BENEFITS:

- Multi-function modular design
- Compact size
- Extra strong neodymium magnetic bit tip
- Locking collar secures tool
- Drill, countersink, counterbore and screw driver functions
- Compact size for improved use and maneuverability
- Convenient on-board hex key for fast tool changes
- Fast and easy drill & driver functions without reChucking
- Strong fastener retention
- 1/4" Non-slip impact hex shank
- Secure locking modular insert



Drill, countersink or counterbore.



Flip the insert.



Drive the screw.

PART NUMBER	DESCRIPTION	ORDER MULTIPLES
MB-64857	#6 Compact Drill & Driver	5
MB-64859	#8 Compact Drill & Driver	5
MB-64860	#10 Compact Drill & Driver	5
MB-64861	#12 Compact Drill & Driver	5
MB-65720	#6 Countersink Insert	5
MB-65721	#8 Countersink Insert	5
MB-65722	#10 Countersink Insert	5
MB-65995	5pc Power Groove Countersinks	5
MB-65727	#6 Replacement Countersink Drill Bits	5
MB-65728	#8 Replacement Countersink Drill Bits	5
MB-65729	#10/12 Replacement Countersink Drill Bits	5
MB-63123	10pc Modular Drill & Drive Set	2

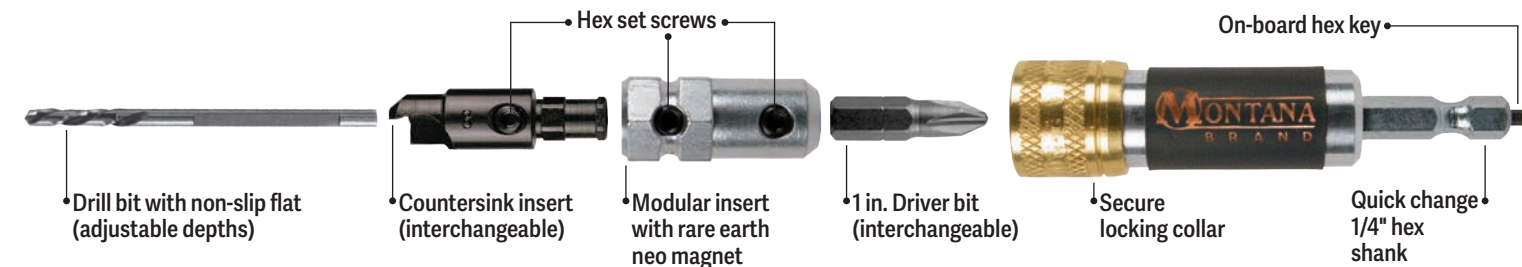

SELF-CENTERING PLUG CUTTERS

NO DRILL PRESS NEEDED!

FEATURES & BENEFITS:

- Unique self-centering design
- Retractable guide pin
- 2-point cutting blades
- CNC precision machined high-alloy steel
- Black oxide finish
- Cut wood plugs with a hand-held portable drill
- Innovative anti-skate design
- Cuts fast and clean
- Stays sharp longer for extended tool life
- Cuts accurate size tapered plugs for tight fit
- Time saving convenience – cut plugs at the job site



PART NUMBER	DESCRIPTION	ORDER MULTIPLES
MB-65915	5/16" Self Centering Plug Cutter	3
MB-65913	3/8" Self Centering Plug Cutter	3
MB-65907	7/16" Self Centering Plug Cutter	3
MB-65919	1/2" Self Centering Plug Cutter	3
MB-65823	3pc (5/16", 3/8", 1/2") Self Centering Plug Cutter	3

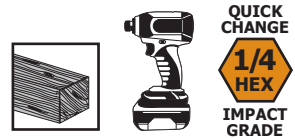
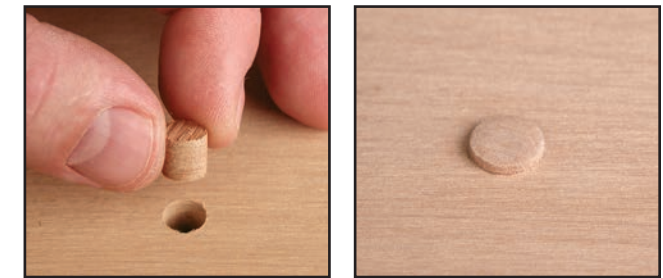

U.S. PATENT NO. 7,578,324

Correct size plug cutter as companion to the countersink inserts



- #6 countersink is a 3/32" drill with a countersink diameter of 5/16". This would use a **5/16 plug cutter**
- #8 countersink is a 7/64" drill with a countersink diameter of 5/16". This would use a **5/16 plug cutter**
- #10 countersink is a 1/8" drill with a countersink diameter of 3/8". This would use a **3/8 plug cutter**
- #12 countersink is a 1/8" drill with a countersink diameter of 7/16". This would use a **7/16 plug cutter**

SELF-CENTERING DRILL & DRIVERS

ALWAYS CENTERED. PERFECTLY ALIGNED PILOT HOLE.

FEATURES & BENEFITS:

- Multi-function modular design
- On-board hex key
- Extra strong neodymium magnetic bit tip
- 1/4" quick change hex shank
- Locking collar secures tool
- Convenient on-board hex key for fast tool changes
- Fast and easy drill & drive functions without rechucking
- Strong fastener retention
- 1/4" Non-slip impact hex shank
- Center drilled pilot holes on hinges, doors, brackets, hardware, drawer slides, etc.

PART NUMBER	DESCRIPTION	ORDER MULTIPLES
MB-65700	#6 Self Centering Drill & Driver	5
MB-65701	#8 Self Centering Drill & Driver	5
MB-65702	#10 Self Centering Drill & Driver	5
MB-65740	#6 Self Centering Replacement Drill Bits	5
MB-65741	#8 Self Centering Replacement Drill Bits	5
MB-65742	#10 Self Centering Replacement Drill Bits	5



Pre-drill pilot hole.



Flip the insert.



Drive the screw.



DRYWALL SCREW SETTER

GETTING THE PROPER DEPTH HAS NEVER BEEN EASIER.

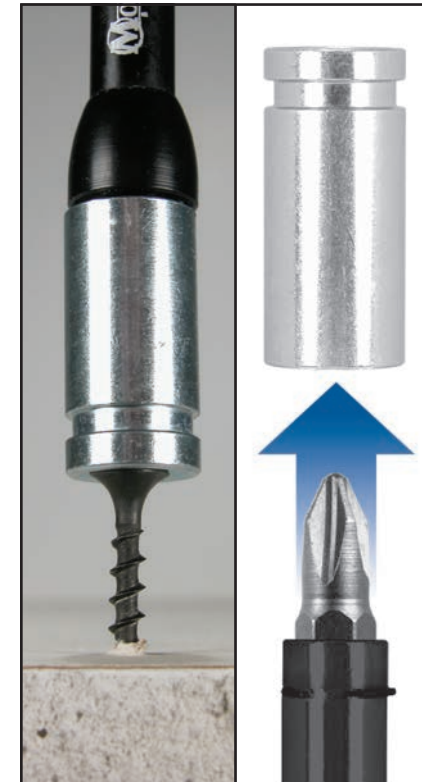

FEATURES & BENEFITS:

- Remove sleeve for easy driver bit replacement
- Extra strong magnet for fastener retention
- Dual-hold driver bit retention
- Improved operation and control
- Added versatility, multi-use
- Non-slip impact hex shank
- Spin-free dimpler sleeve
- Quick-change compatible
- Combination magnetic bit holder and screw setter
- Countersink screws accurately in drywall, particle board, and plywood

PART NUMBER	DESCRIPTION	ORDER MULTIPLES
MB-03027	7pc 2-IN-1 Drywall Screw Setter Set	5

U.S. PATENT NO. 8,733,216

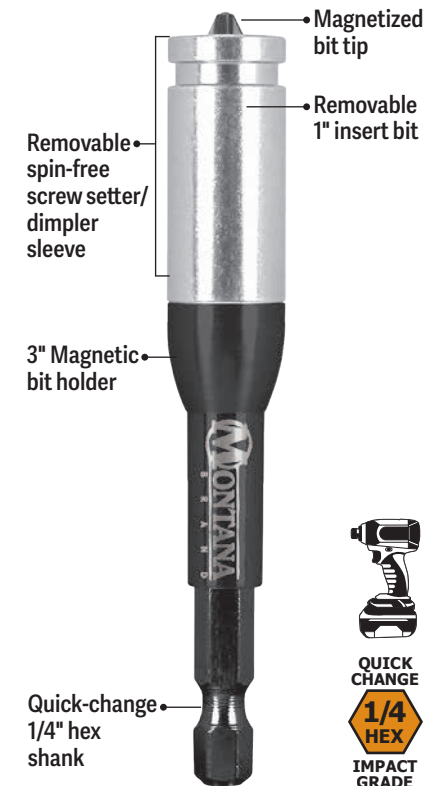

DRYWALL CUT-OUT BITS

CUTS DRYWALL LIKE BUTTER.



PART NUMBER	DESCRIPTION	ORDER MULTIPLES
MB-63191	2pc - 1/8" Drywall Cut-Out Bits	5
MB-63193	2pc - 3/16" Drywall Cut-Out Bits	5
MB-63192	10pc - 1/8" Drywall Cut-Out Bits	5
MB-63194	10pc - 3/16" Drywall Cut-Out Bits	5

FEATURES & BENEFITS:

- Center ground point gash for plunge cuts into drywall
- Downward spiral is designed to push dust into wall and away from you
- Precision ground high speed steel
- Piloted tracing tip for perfect clearance and easy drywall installation
- Smooth cutting with minimal surface tearing
- Reduced in-use noise/squeal and generates less dust
- Pro-grade quality for long tool life



For use with high speed rotary tools.

MAGNETIC NUT DRIVERS

IMPACT STEEL - 850LBS. OF PURE TORQUE.

FEATURES & BENEFITS:

- Designed and engineered to ensure accurate specifications and superior quality
- Manufactured utilizing premium shock resistant S2 steel to reduce stress fractures and accessory failure
- Proprietary, task specific heat treatment to control hardness for superior strength
- Engineered and machined to prevent slipping and stripping
- Extra-strong neo-magnet for fastener and nut retention
- High resistance to abrasion for extended life and performance
- Industry-leading torque and impact rating

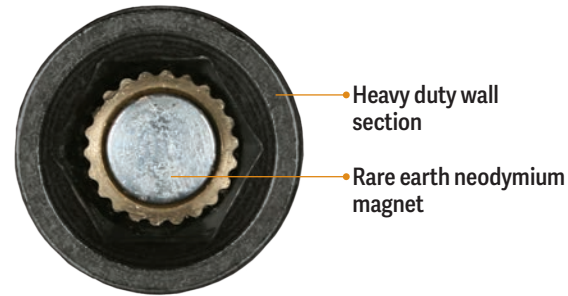

SIZE	2" STANDARD PART NUMBER	2-9/16" EXTENDED PART NUMBER	ORDER MULTIPLES
1/4"	MB-65990	MB-66140	5
1/4" - 25pc Cookie Jar	MB-67011	MB-67015	1
5/16"	MB-65991	MB-66141	5
5/16" - 25pc Cookie Jar	MB-67012	MB-67016	1
3/8"	MB-65992	MB-66142	5
3/8" - 25pc Cookie Jar	MB-67013	MB-67017	1
7/16"	MB-65993	MB-66143	5
7/16" - 25pc Cookie Jar	MB-67014	MB-67018	1
4pc-All Sizes	MB-65994	MB-66144	5



TESTING PROTOCOL:

Nut driver test size: 5/16 in.

Sample size: 5 (high/low torque ratings eliminated)

Test Equipment: Tinius Olsen torque testing equipment

Sampled tools under torque load to failure, driven by shank and mandrel inserted into receiving cavity.

Test Results

Brand	Size (inches)	Mfg. Origin	Hardness	Torque Rating (Pounds)	Failure Point
RMT Impact Steel	5/16	USA	53.6 (S2)	864	Shank Failure
RMT Impact Steel	5/16	USA	53.4 (S2)	860	Shank Failure
RMT Impact Steel	5/16	USA	54.1 (S2)	894	Shank Failure
DEWALT	5/16	China	54.2 (CRV)	484	Rounded Broach
DEWALT	5/16	China	55.6 (CRV)	426	Rounded Broach
DEWALT	5/16	China	48.1 (CRV)	320	Rounded Broach
Craftsman	5/16	USA	45.5 (CRV)	618	Shank Failure
Craftsman	5/16	USA	46.7 (CRV)	632	Shank Failure
Craftsman	5/16	USA	48.2 (CRV)	613	Shank Failure
Milwaukee Shock Wave	5/16	China	55.8 (CRV)	506	Shattered Broach
Milwaukee Shock Wave	5/16	China	59.5 (CRV)	511	Shattered Broach
Milwaukee Shock Wave	5/16	China	58.4 (CRV)	502	Shattered Broach

DRIVER BITS

CRYO XTREME FOR XTREME DRIVING.

FEATURES & BENEFITS:

- Available in 1", 2", & 3" and made of S2 modified steel
- 1/4" quick change hex shank on 2" & 3" driver bits for fast tool changes without having to rechunk
- Cryogenically treated adding to the mechanical properties of the bits to provide:
 - Less tool failure due to cracking
 - Increased life of the tool & torsion strength
 - Increased rust resistance

SIZE	PART NUMBER	DESCRIPTION	ORDER MULTIPLES
1"	MB-65009	⊕ Phillips #1 - 2pc	5
1"	MB-67101	⊕ Phillips #1 - 200pc	1
1"	MB-65010	⊕ Phillips #2 - 2pc	5
1"	MB-66150	⊕ Phillips #2 - 20pc	5
1"	MB-67102	⊕ Phillips #2 - 200pc	1
1"	MB-65014	⊕ Phillips #3 - 2pc	5
1"	MB-67103	⊕ Phillips #3 - 200pc	1
1"	MB-65027	⊖ Square #1 - 2pc	5
1"	MB-67104	⊖ Square #1 - 200pc	1
1"	MB-65028	⊖ Square #2 - 2pc	5
1"	MB-66151	⊖ Square #2 - 20pc	5
1"	MB-67105	⊖ Square #2 - 200pc	1
1"	MB-65030	⊖ Square #3 - 2pc	5
1"	MB-67106	⊖ Square #3 - 200pc	1
1"	MB-67111	☆ Star #10 - 200pc	1
1"	MB-67112	☆ Star #15 - 200pc	1
1"	MB-65043	☆ Star #20 - 2pc	5
1"	MB-67113	☆ Star #20 - 200pc	1
1"	MB-65044	☆ Star #25 - 2pc	5
1"	MB-66153	☆ Star #25 - 20pc	5
1"	MB-67114	☆ Star #25 - 200pc	1
1"	MB-67115	☆ Star #30 - 200pc	1
1"	MB-67107	⊖ Slotted 4-6 - 200pc	1
1"	MB-67108	⊖ Slotted 6-8 - 200pc	1
1"	MB-67109	⊖ Slotted 8-10 - 200pc	1
2"	MB-65019	⊕ Phillips #1 - 1pc	5
2"	MB-67201	⊕ Phillips #1 - 100pc	1
2"	MB-65020	⊕ Phillips #2 - 1pc	5
2"	MB-67202	⊕ Phillips #2 - 100pc	1
2"	MB-65124	⊕ Phillips #3 - 1pc	5
2"	MB-67203	⊕ Phillips #3 - 100pc	1
2"	MB-65037	⊖ Square #1 - 1pc	5
2"	MB-67204	⊖ Square #1 - 100pc	1
2"	MB-65038	⊖ Square #2 - 1pc	5
2"	MB-67205	⊖ Square #2 - 100pc	1
2"	MB-65140	⊖ Square #3 - 1pc	5
2"	MB-67206	⊖ Square #3 - 100pc	1
2"	MB-67211	☆ Star #10 - 100pc	1
2"	MB-67212	☆ Star #15 - 100pc	1
2"	MB-65153	☆ Star #20 - 1pc	5
2"	MB-67213	☆ Star #20 - 100pc	1
2"	MB-65054	☆ Star #25 - 1pc	5
2"	MB-67214	☆ Star #25 - 100pc	1
2"	MB-67215	☆ Star #30 - 100pc	1

SIZE	PART NUMBER	DESCRIPTION	ORDER MULTIPLES
2"	MB-67207	⊖ Slotted 4-6 - 100pc	1
2"	MB-65055	⊖ Slotted 6-8 - 1pc	5
2"	MB-67208	⊖ Slotted 6-8 - 100pc	1
2"	MB-65056	⊖ Slotted 8-10 - 1pc	5
2"	MB-67209	⊖ Slotted 8-10 - 100pc	1
3"	MB-65730	⊕ Phillips #1 - 1pc	5
3"	MB-67301	⊕ Phillips #1 - 75pc	1
3"	MB-65731	⊕ Phillips #2 - 1pc	5
3"	MB-67302	⊕ Phillips #2 - 75pc	1
3"	MB-65732	⊕ Phillips #3 - 1pc	5
3"	MB-67303	⊕ Phillips #1 - 75pc	1
3"	MB-65733	⊖ Square #1 - 1pc	5
3"	MB-67304	⊖ Square #1 - 75pc	1
3"	MB-65734	⊖ Square #2 - 1pc	5
3"	MB-67305	⊖ Square #2 - 75pc	1
3"	MB-65735	⊖ Square #3 - 1pc	5
3"	MB-67306	⊖ Square #3 - 75pc	1
3"	MB-65736	☆ Star #20 - 1pc	5
3"	MB-67313	☆ Star #20 - 75pc	1
3"	MB-65737	☆ Star #25 - 1pc	5
3"	MB-67314	☆ Star #25 - 75pc	1



COOKIE JAR COUNTERTOP DISPLAY

COMPACT SIZE, BIG SALES.

FEATURES & BENEFITS:

- More cost effective with bulk pricing
- Great selection of our most popular driving accessories
- Ideal for promoting point of purchase sales



*Also available with driver bits, see page 10 for size and style options, header is included.

PART NUMBER	DESCRIPTION	ORDER MULTIPLES
MB-67001	25pc - 1/4" Knurled Connector	1
MB-67002	25pc - Compact Screw Guide	1
MB-67003	25pc - 3" Compact Bit Holder	1
MB-67004	25pc - Dry Wall Screw Setter	1
MB-67011	25pc - 1/4" x 2" Nut Setter	1
MB-67012	25pc - 5/16" x 2" Nut Setter	1
MB-67013	25pc - 3/8" x 2" Nut Setter	1
MB-67014	25pc - 7/16" x 2" Nut Setter	1
MB-67015	25pc - 1/4" x 2 9/16" Nut Setter	1
MB-67016	25pc - 5/16" x 2 9/16" Nut Setter	1
MB-67017	25pc - 3/8" x 2 9/16" Nut Setter	1
MB-67018	25pc - 7/16" x 2 9/16" Nut Setter	1

QUICK CHANGE CONNECTOR

FASTER. EASIER. SECURE LOCK, NON-SLIP CONNECTION.

FEATURES & BENEFITS:

- Durable steel construction with secure locking collar
- Compatible with all 1/4" hex shank accessories
- Fast, easy, and convenient accessory changes without rechucking
- Eliminates tool from slipping in drill chuck

PART NUMBER	DESCRIPTION	ORDER MULTIPLES
MB-65780	1/4" Quick Change Connector	5



Spring loaded collar locks in hex shank accessories



Fits all 3/8" and 1/2" drill/drivers



QUICK CHANGE
1/4" HEX
IMPACT GRADE

DEPTH STOP SCREW GUIDE

ADJUSTABLE & VERSATILE FOR REPEATABLE PRECISION.

FEATURES & BENEFITS:

- Drive screws to consistent, repeatable depths
- Drive screws straight without fastener wobble
- Reduces material surface damage
- Magnetic bit tip for screw retention
- Easy driver bit replacement
- Improved control and versatility
- Multi-operation/applications
- Non-slip hex shank
- Quick-change compatible
- Tough, durable construction

PART NUMBER	DESCRIPTION	ORDER MULTIPLES
MB-03029	4pc Adj. Screw Guide Set	5



QUICK CHANGE
1/4" HEX
IMPACT GRADE



SCREW GUIDES/BIT HOLDER

DRIVE WITHOUT WOBBLE. DRIVE LIKE A PRO.

FEATURES & BENEFITS:

- Spin-free screw guide sleeve
- Strong neodymium magnet
- 1/4" impact hex shank
- Quick-change compatible
- Tough, durable construction
- Removable driver bit
- Drive screws straight without fastener wobble
- Reduces material surface damage
- Magnetic bit tip for screw retention
- Easy driver bit replacement
- Superior control and versatility
- Hands free operation

PART NUMBER	DESCRIPTION	ORDER MULTIPLES
MB-65711	Compact Screw Guide	5
MB-65712	Standard Screw Guide	5
MB-65725	3" Magnetic Bit Holder	5
MB-67002	25pc Comp. Screw Guide Cookie Jar	1



CUT AWAY VIEW

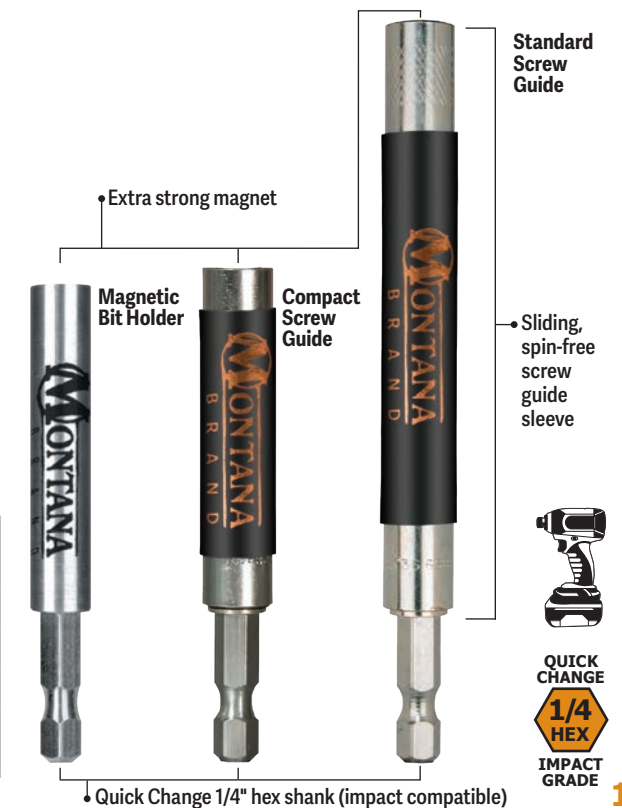

Standard Screw Guide



QUICK CHANGE
1/4" HEX
IMPACT GRADE

Quick Change 1/4" hex shank (impact compatible)

DRILLING AND DRIVING SETS

PROFESSIONAL GRADE FOR HOMEOWNERS TO CONTRACTORS.

PART NUMBER	DESCRIPTION	ORDER MULTIPLES
MB-63123	10pc Modular Drill & Drive Set	2
MB-64340	14pc Titanium Hex Shank Drill Bit Set	2
MB-63122	16pc Self-Centering Drill & Driver Set	2
MB-64855	20pc Drill & Drive Set	2
MB-63127	25pc Drill & Drive Set	2
MB-64866	26pc Power Driving Set	2
MB-64869	27pc Drill & Drive Set	2
MB-63126	28pc Drill & Drive Set	2
MB-64871	29pc BlackGold Tri-Flat Shank Set	2
MB-64874	29pc Cobalt HSS Round Shank Set	2
MB-64858	39pc Drill & Drive Set	2
MB-65944	45pc Drill & Drive Set	2
MB-63129	48pc Complete Woodworkers Set	2
MB-63130	53pc Woodworking Drill & Drive Set	2



25pc Drill & Drive Set

DRILLING AND DRIVING SETS

PROFESSIONAL GRADE FOR HOMEOWNERS TO CONTRACTORS.



45pc Drill & Drive Set



16pc Self-Centering Drill & Driver Set



10pc Modular Drill & Drive Set



20pc Drill & Drive Set



26pc Drill & Drive Set



27pc Drill & Drive Set

DRILLING AND DRIVING SETS

PROFESSIONAL GRADE FOR HOMEOWNERS TO CONTRACTORS.



14pc Titanium Coated Drilling Set

28pc Drill & Drive Set

DRILL BIT SETS

PROFESSIONAL GRADE FOR HOMEOWNERS TO CONTRACTORS.



1/16" - 1/2" by 64ths

1/16" - 1/2" by 64ths

29pc BlackGold Drill Bit Set

29pc Cobalt Drill Bit Set



48pc Complete Woodworkers Set

53pc Woodworking Drill & Drive Set

GET SOCIAL WITH MONTANA BRAND TOOLS

FIND US ON ALL SOCIAL PLATFORMS @MONTANABRANDTOOLS

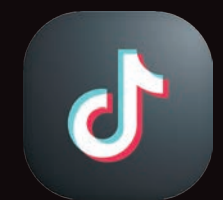



Rocky Mountain Twist | 34837 Innovation Drive | Ronan, MT 59864 | Tel: (406) 528-4350 | Fax: (406) 676-8415