



# MD-600 Pro

## EXTRA LARGE SELF-LEVELING 3D PRINTER

Industrial grade, larger, more stable, more precise and simpler.





# Our 10 Advantages



Leakage  
Protection



High-speed  
Printing

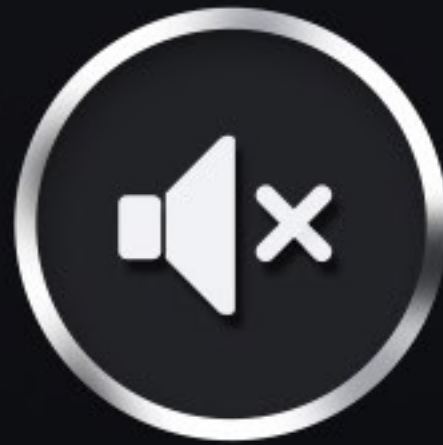

Ultra-quiet



PEI  
Platform



Recover  
Printing



High temperature  
printing at 350°C



Oversized  
Printing



U disk/  
SD Card Printing



±0.1  
Accuracy



Learn In  
2H



# Large Printing Size

Large Printing Size: 600\*600\*600mm

Machine size: 1200\*930\*1030mm

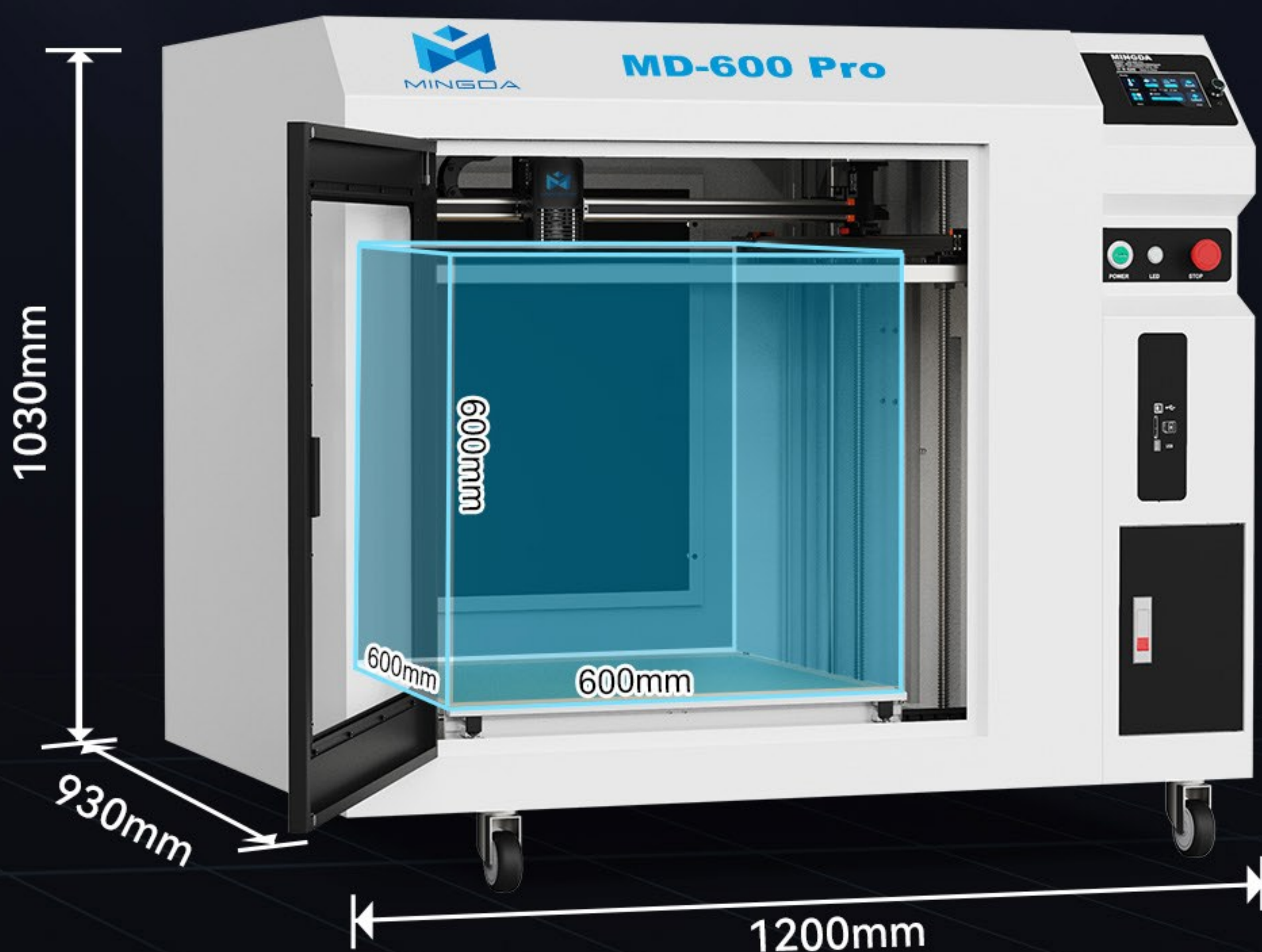

## We Provide The Following Promises

Good after-sales service is the key to test whether a company manufactures high-quality products



One Year  
Warranty



Lifetime  
Maintenance



Factory  
Direct Sales



Quality  
Assurance



Technical  
Support



# Assembled & Fully Enclosed Chamber

- The MD-600 Pro is assembled already after strict testing before it leaves the factory, and can be used directly after customer receives it.
- The MD-600 Pro 's metal frame is fully enclosed, ensuring consistent print temperatures. Its acrylic door offer easy visual monitoring throughout the print process and ensure safety, making it the perfect additive system for industrial environments.

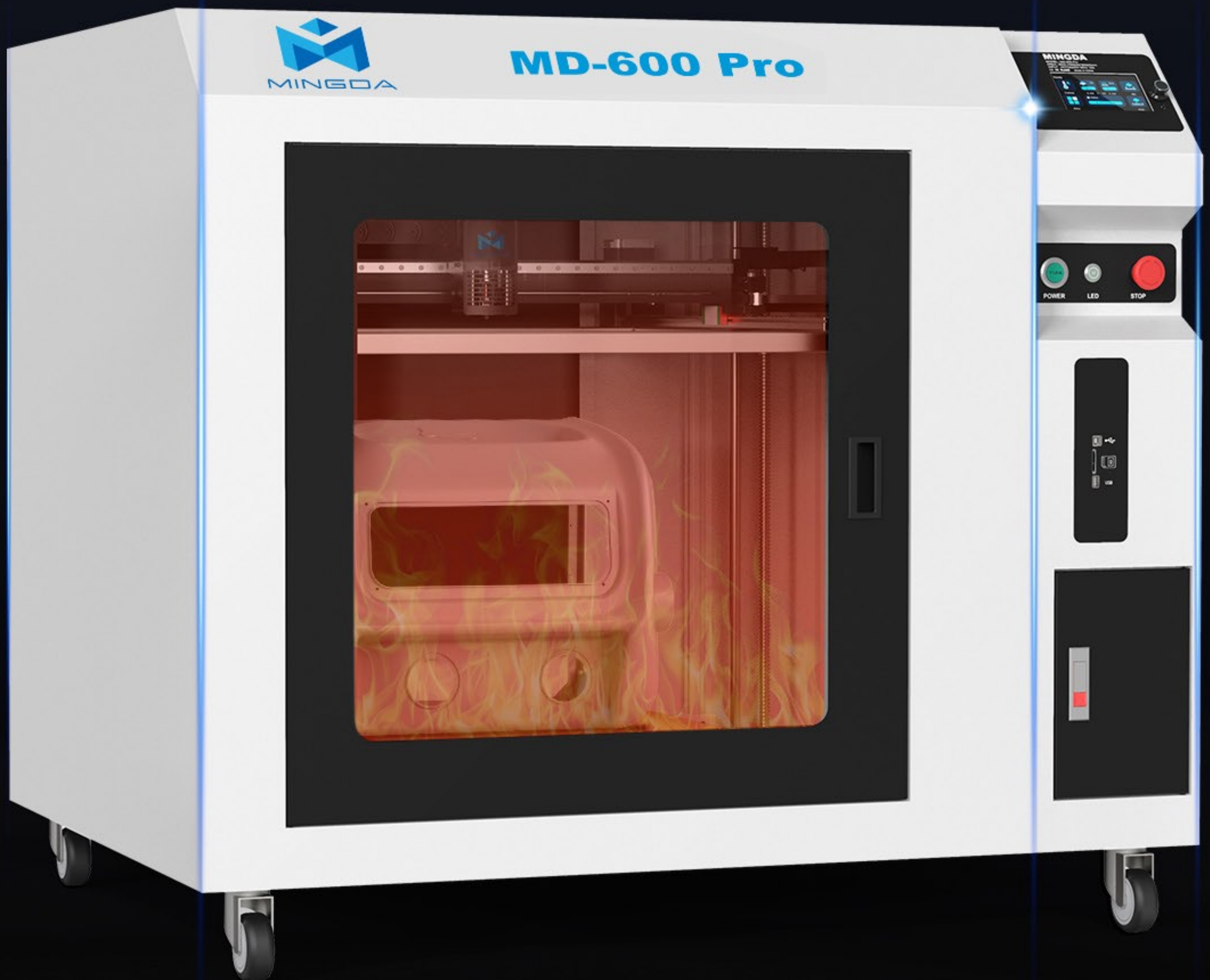



# WORRY FREE LEVELING

The intelligent leveling system can automatically adjust the uneven hotbed.  
High-sensitivity sensor, one-touch leveling and 25-point precise leveling.

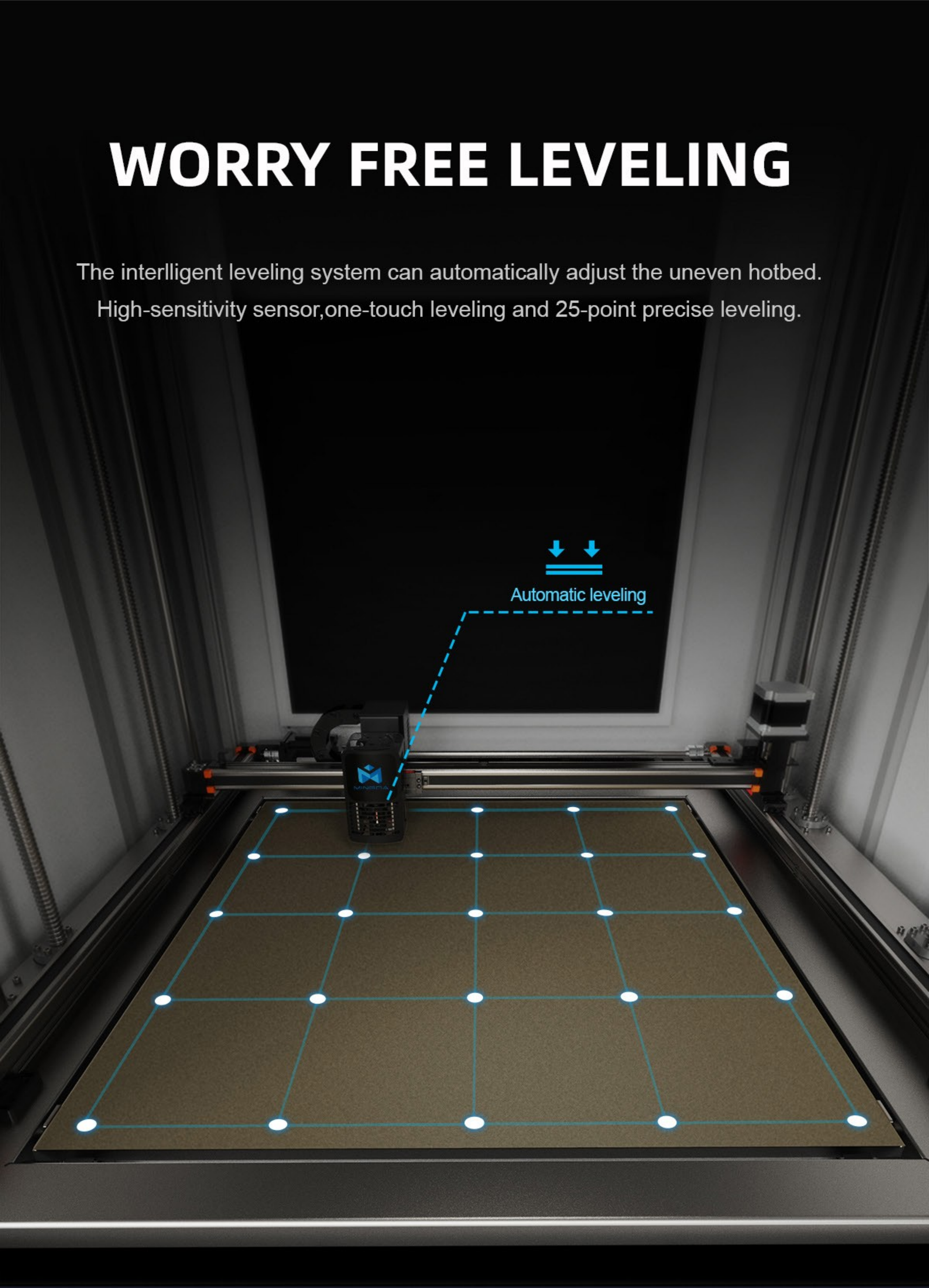



# TWO TEMPERATURE MODES

## TO MEET DIFFERENT MATERIAL REQUIREMENTS

MD-600 Pro is a flexible, high performance and commercial industrial 3d printer. It's equipped with two types of extruders, therefore various printing needs can be met selecting the matching module according to different types of filaments.

EXTRUDER **HT**

Higher 250 degrees  
(High Temperature Hot End)

EXTRUDER **N**

Below 250 degrees  
(Normal Hot End)

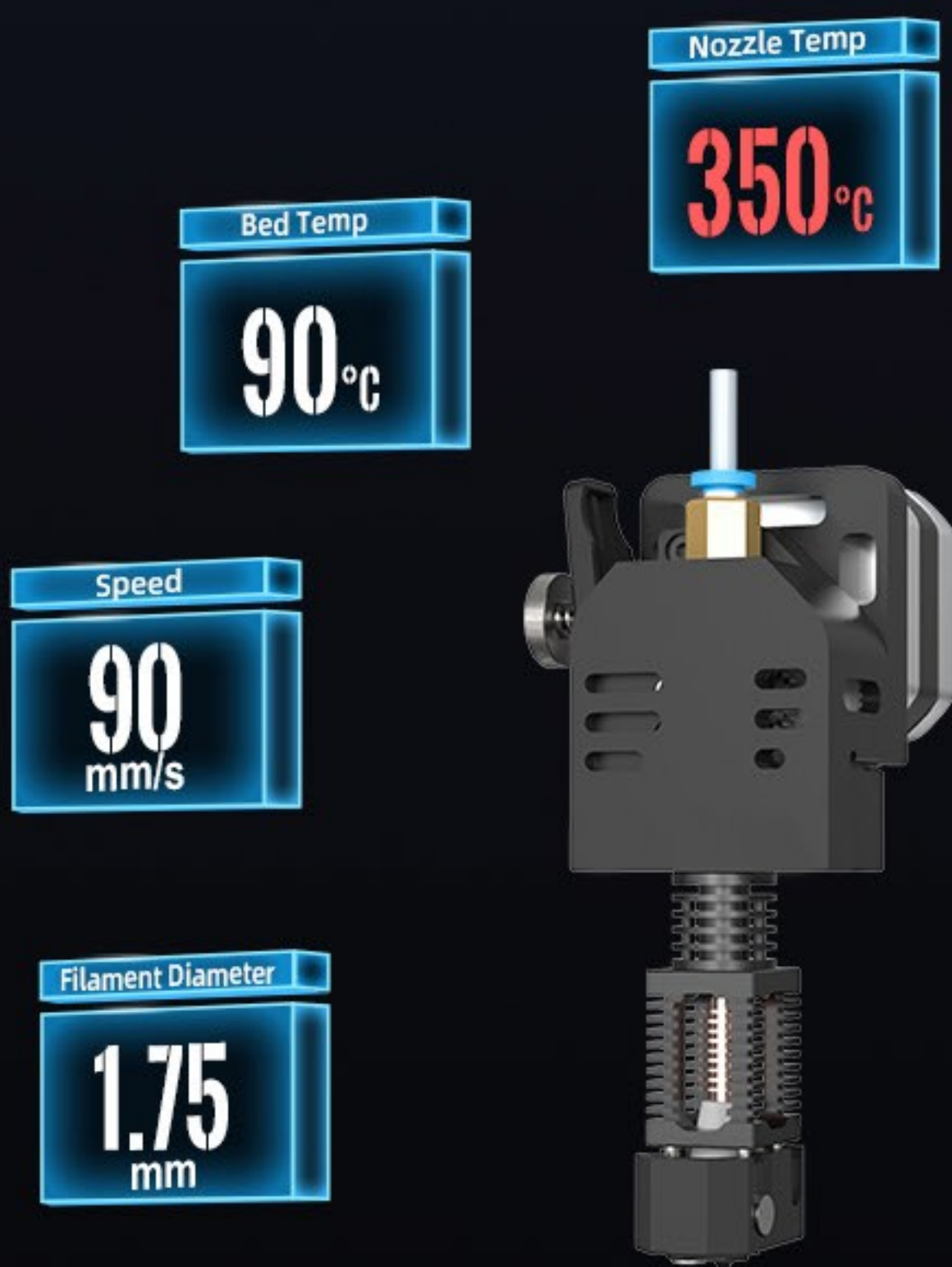

Filament				
PET -CF	PET -GF	PA12 -CF	HtPA -GF	HtPA -CF
HtPA	PETG	PETG -ESD	ABS	ASA

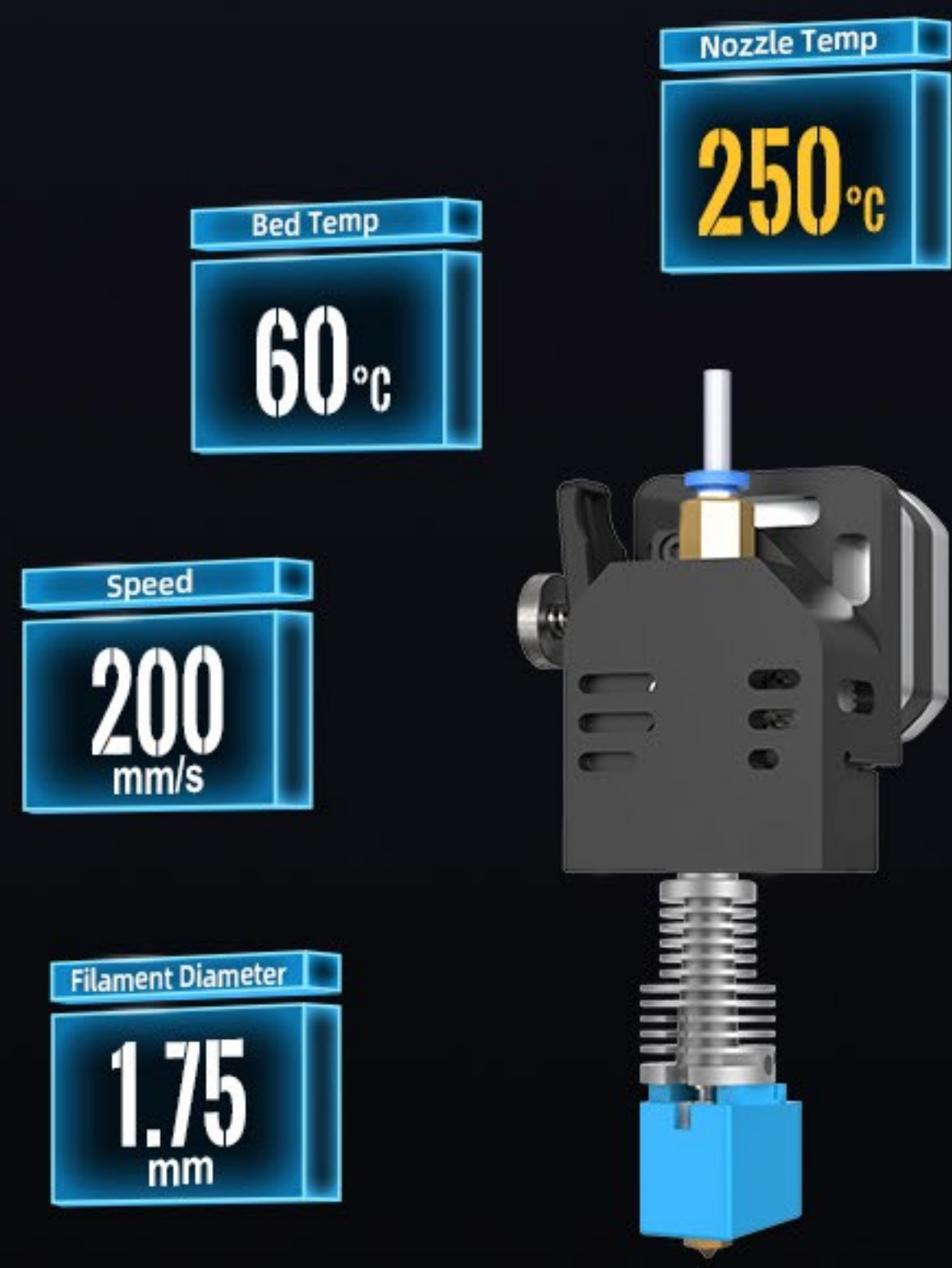

Filament			
TPU 95A	TPU -85A	TPU -Foam	PLA



# PEI Platform



High adhesion



Easy remove  
models after cooling



Non-deformation

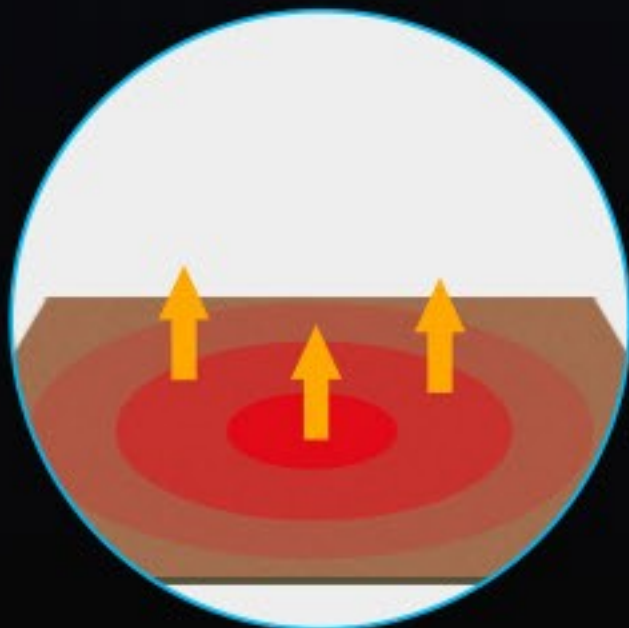

Fast heating up

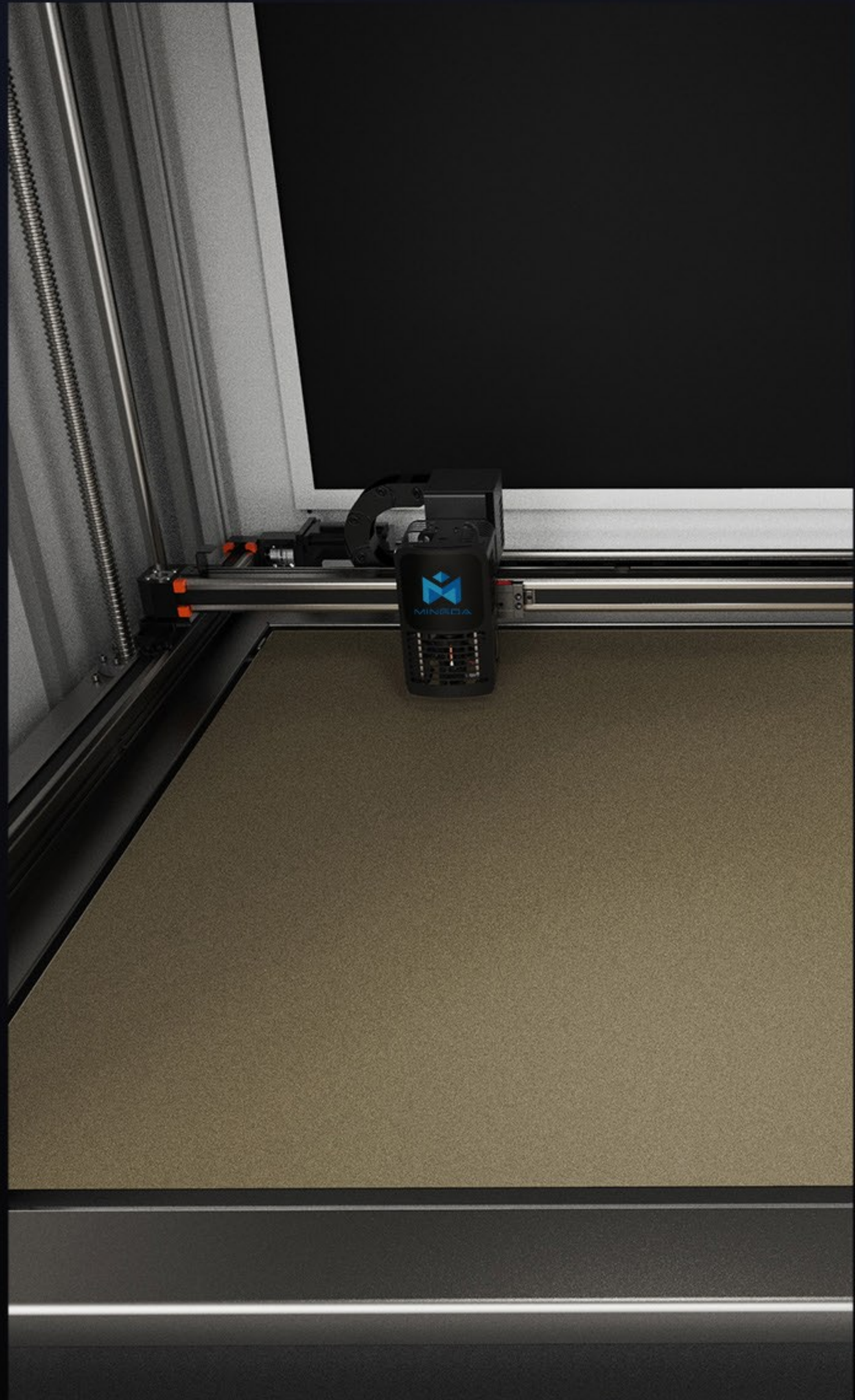



# Beyond Fast

## A New Experience for High-speed 3D Printing

- 200 mm / s High-speed printing
- Industrial Grade Precision Setup
- Fast, Precise Stable and Powerful Performance

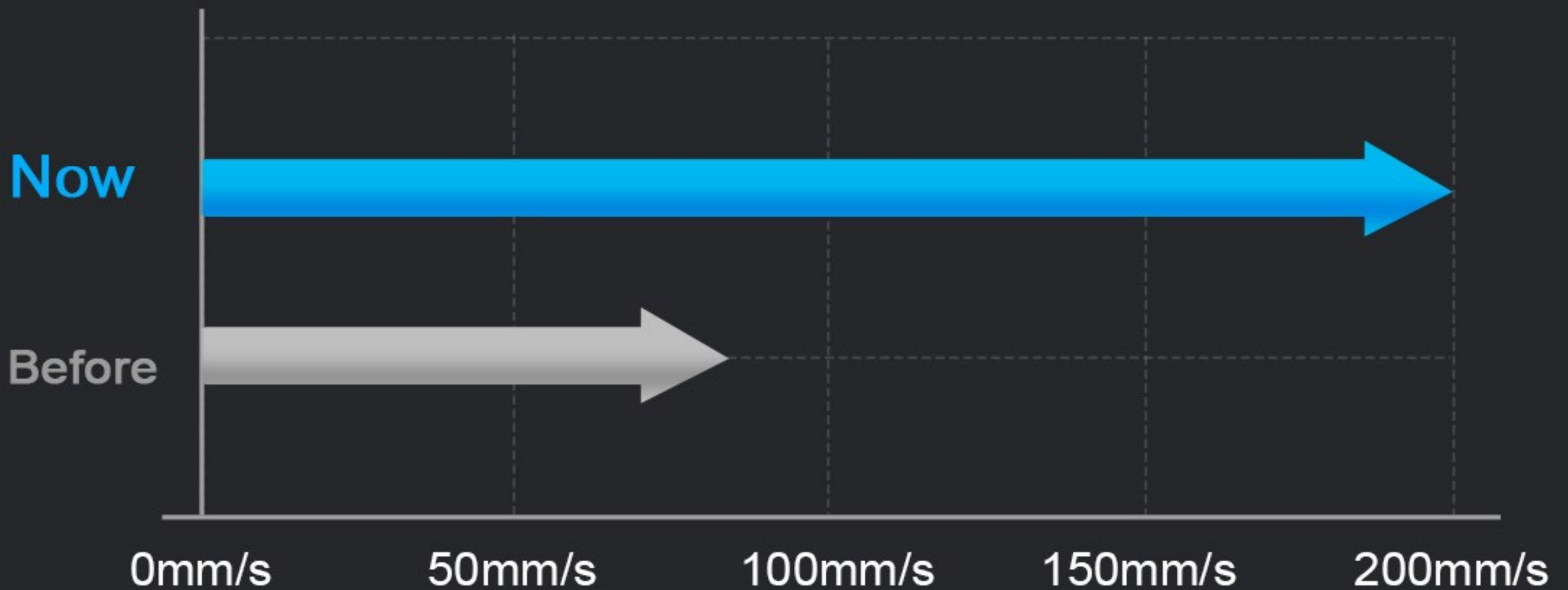



# Make Your Model More Perfect

Large-scale printed models the appearance of 4 to 5 times more precision than ordinary 3D printing

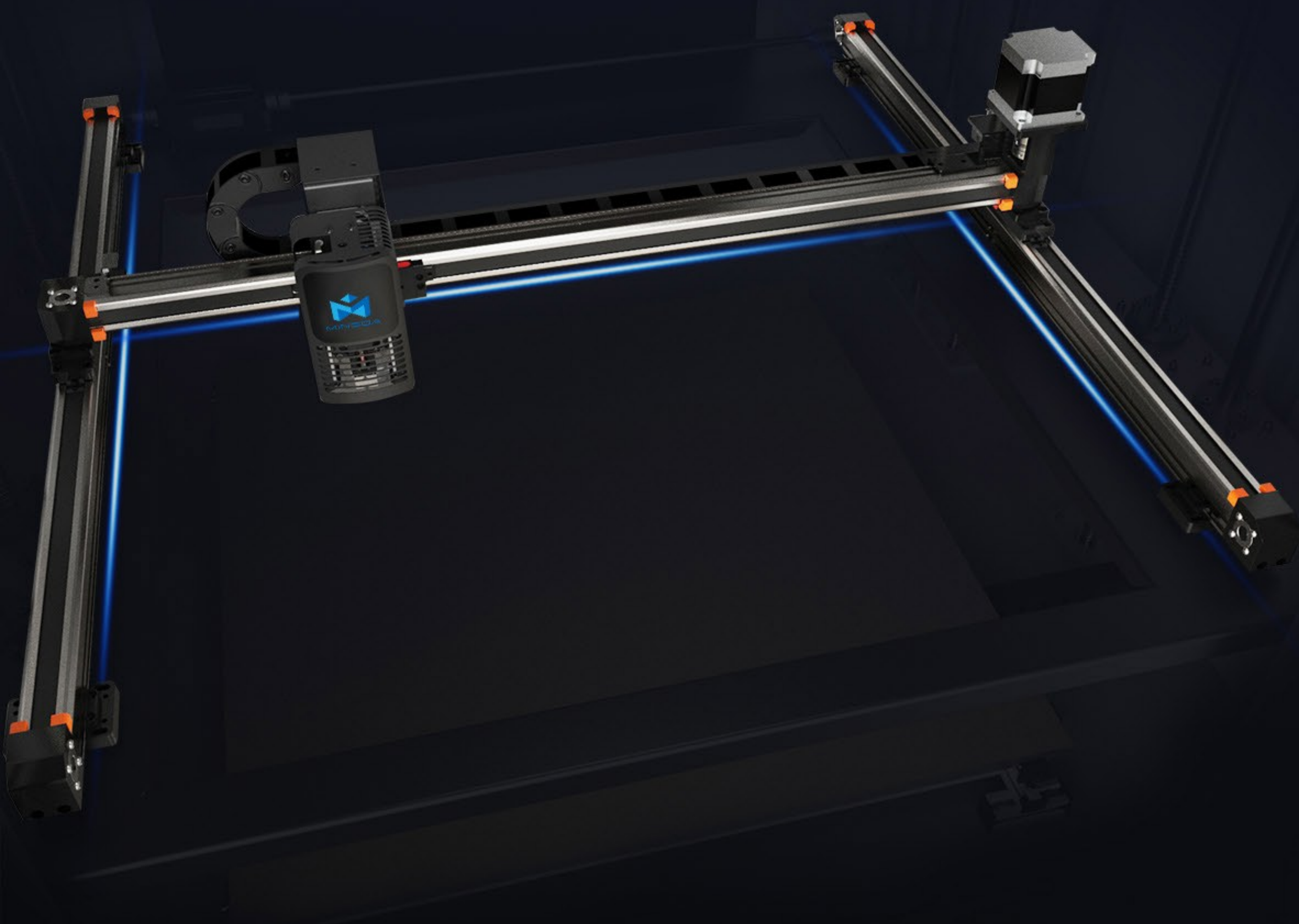

**MD-600 Pro**



**Ordinary 3D printing**



# Upgraded Silent Motherboard

MD-600 Pro uses a more powerful 32-bit motherboard independently developed by a MINGDA professional internal team



Cortex-M4

## Intelligent Design

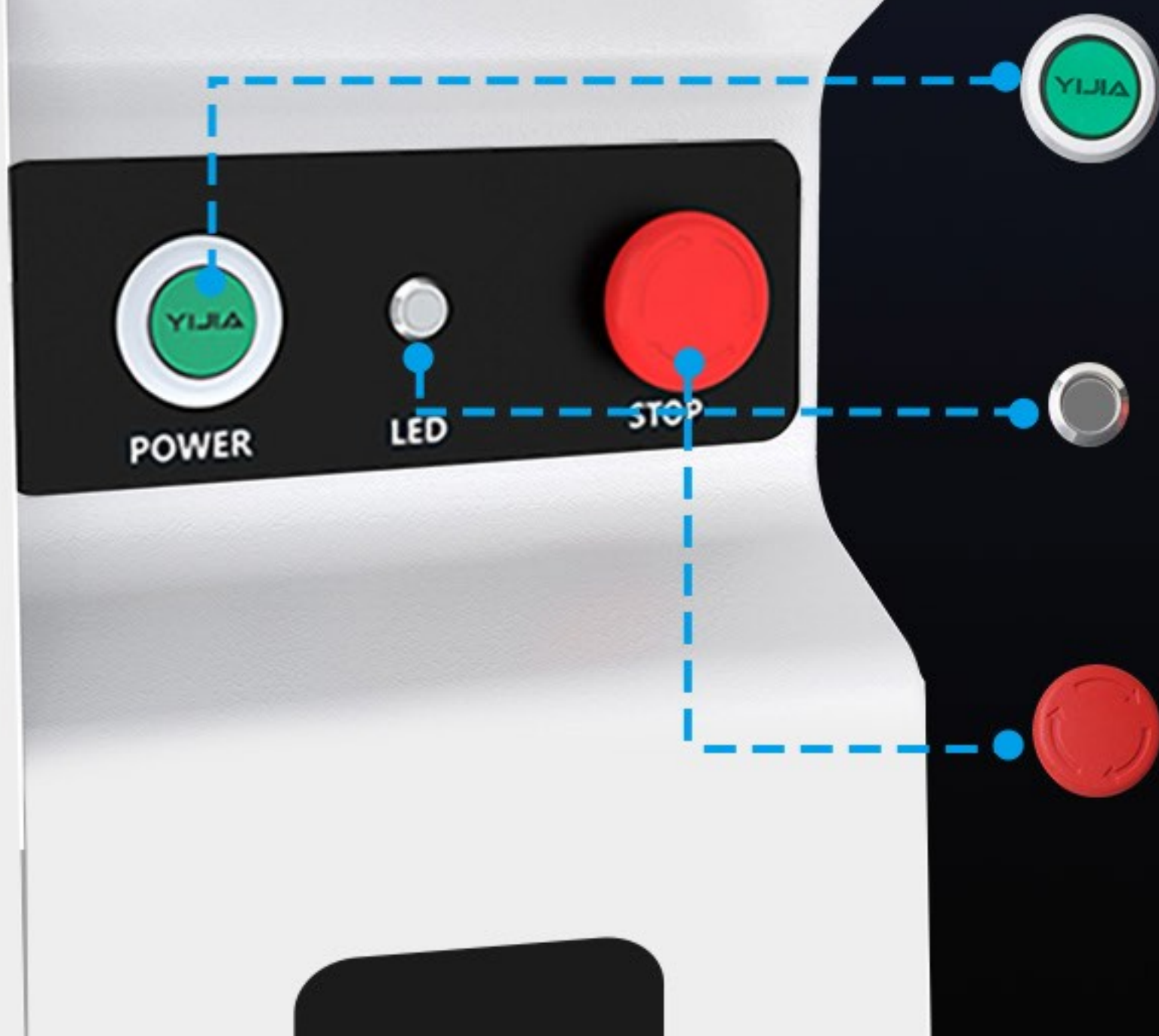

### Power Switch

Industrial power button  
With automatic shutdown after printing

### LED Light Switch

### Emergency Stop Button

More safe and easy to use



# Self-Developed Slicing Software

Slices can be cut in a few minutes, easy to achieve fast printing, and achieve higher quality and more detailed printing effects. Compatible files are wider, including STL, OBJ, X3D, 3MF, BMP, GIF, JPG, PNG.

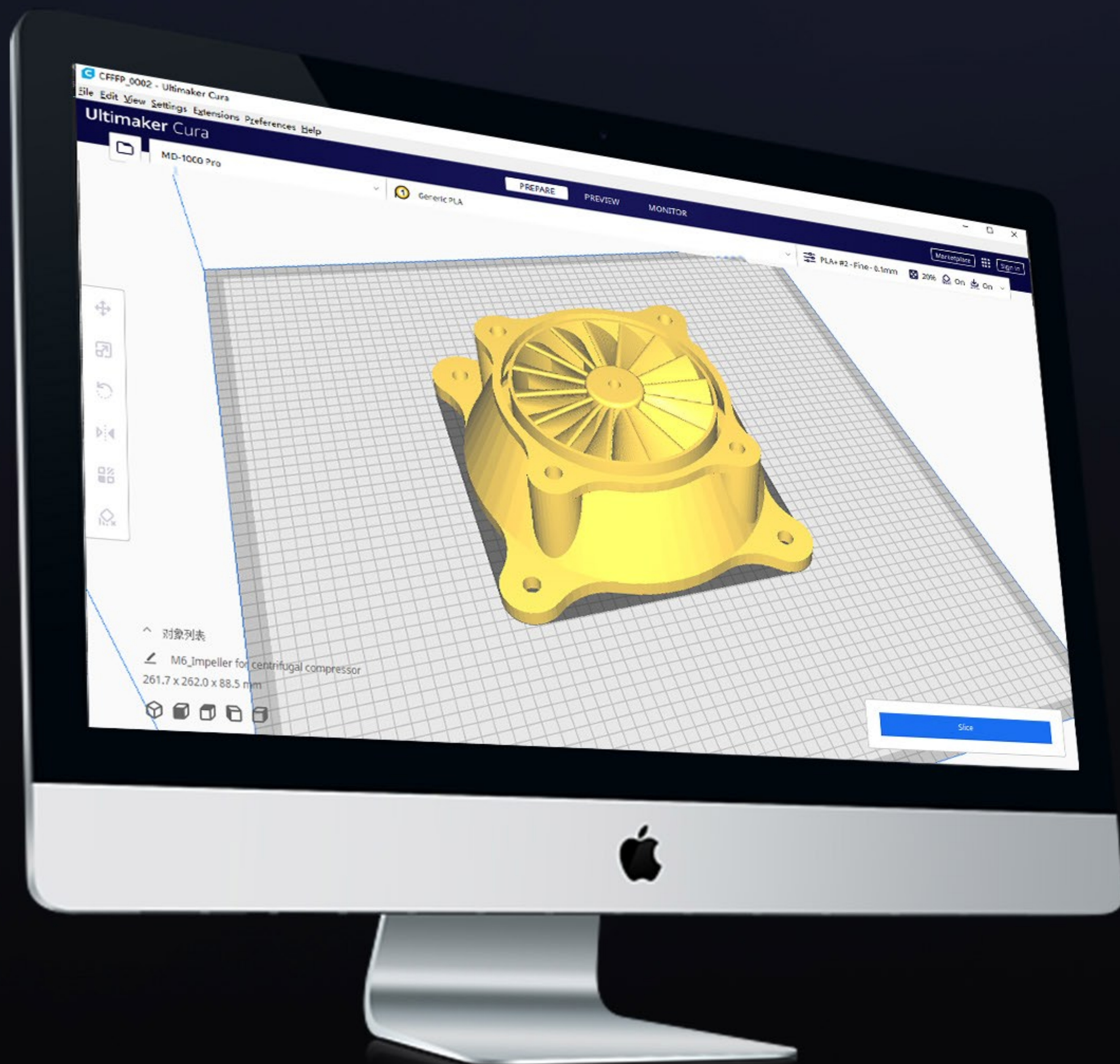



# Recover Printing

Printing can be continued after power-on/filament renewal

When a sudden power failure or filament running out occurs, the current printing task will be automatically stopped, saving materials, increasing the printing success rate and continuing your work at any time.

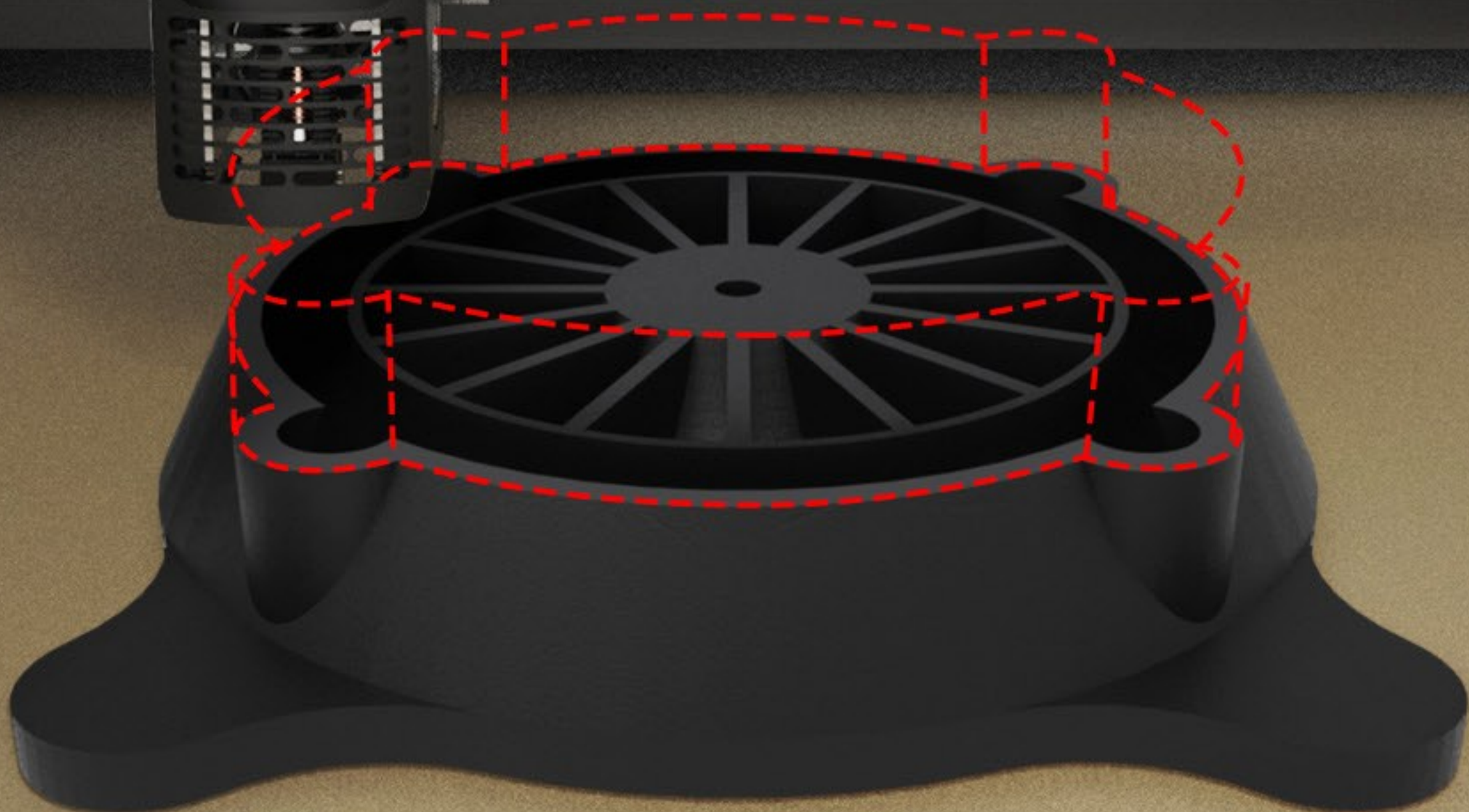



# Other Advantages

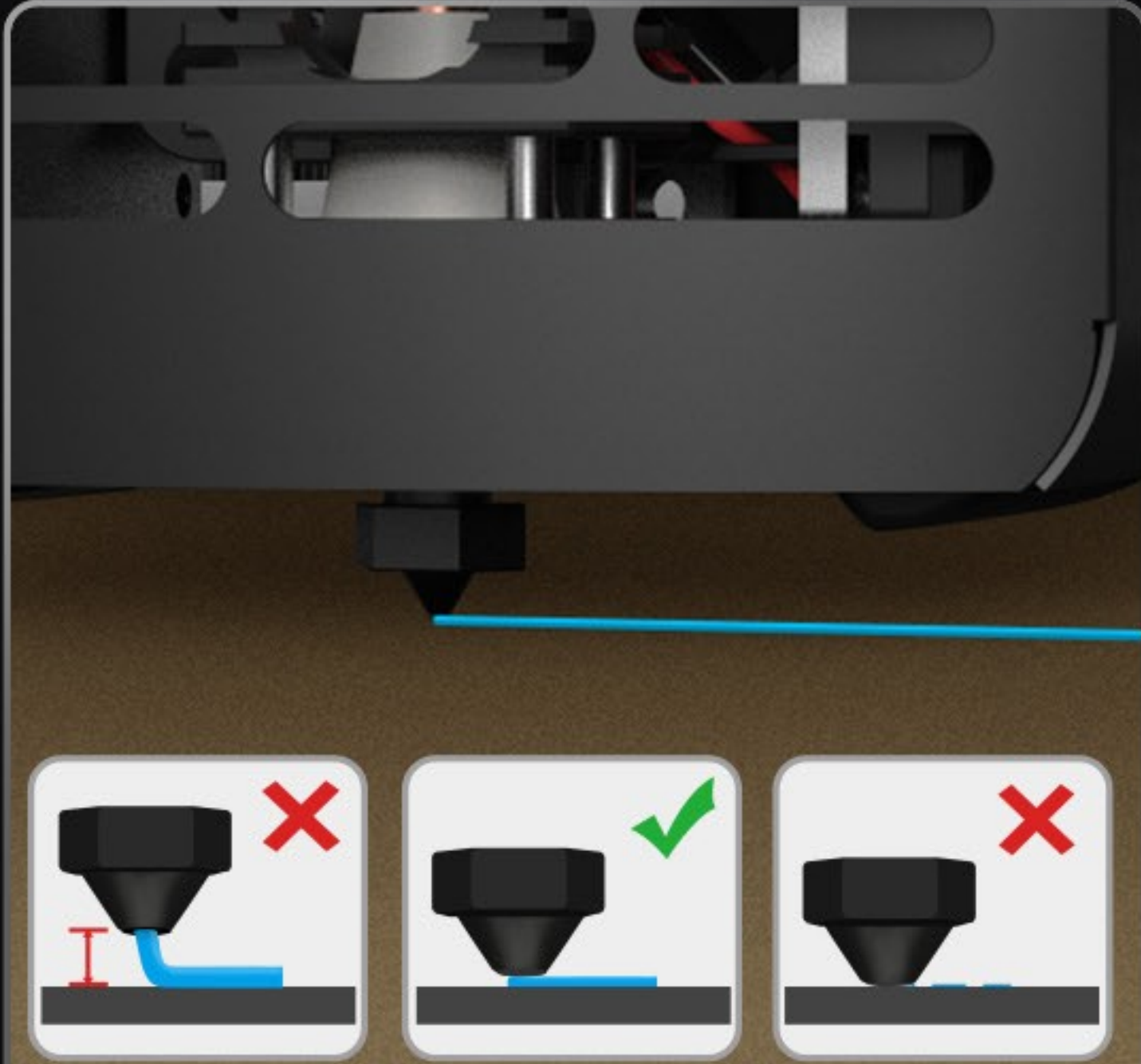

Equipped with Babystep intelligent compensation function to ensure the success rate of printing the first layer of the model

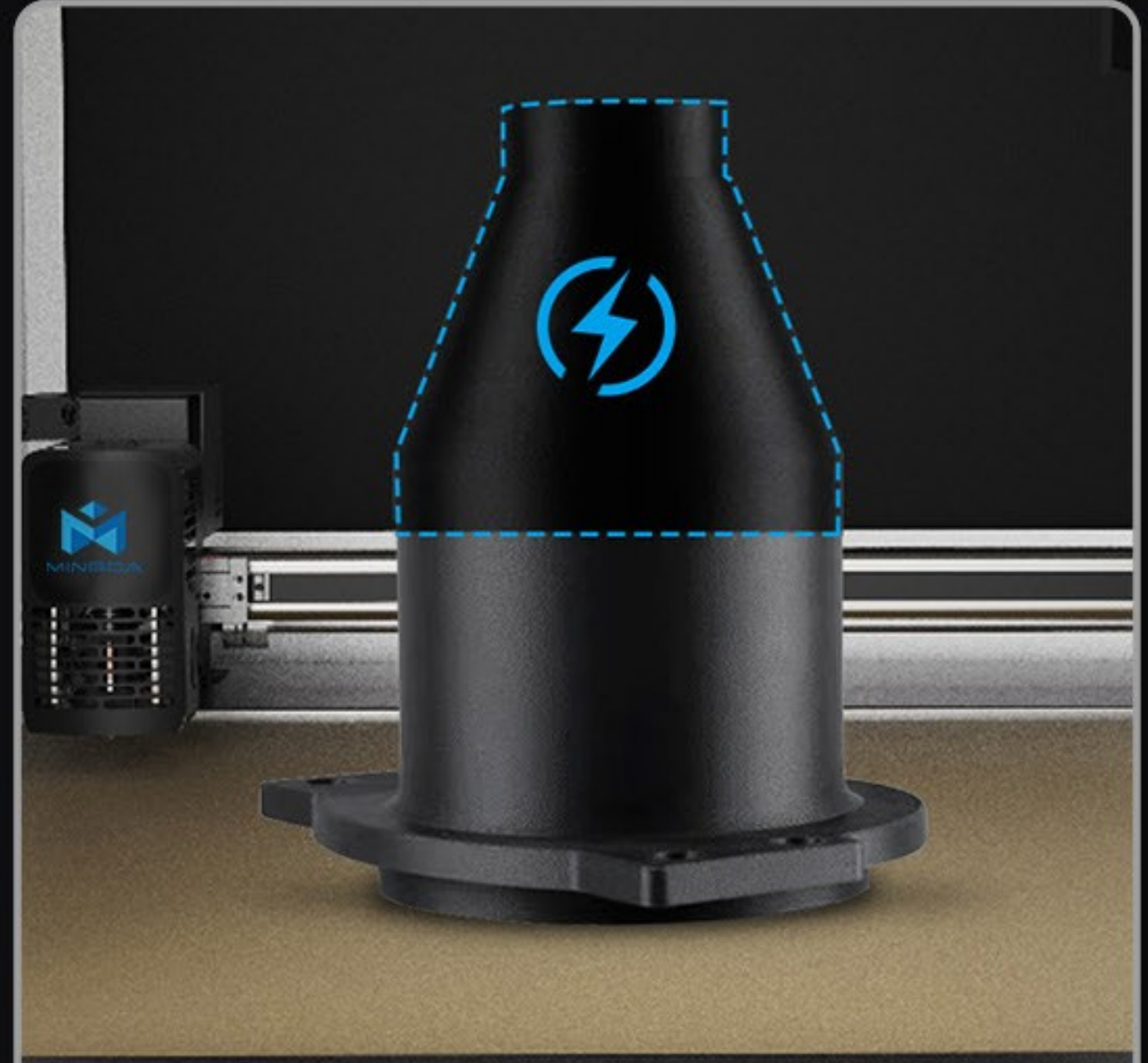

A new generation of intelligent power-off continuous play

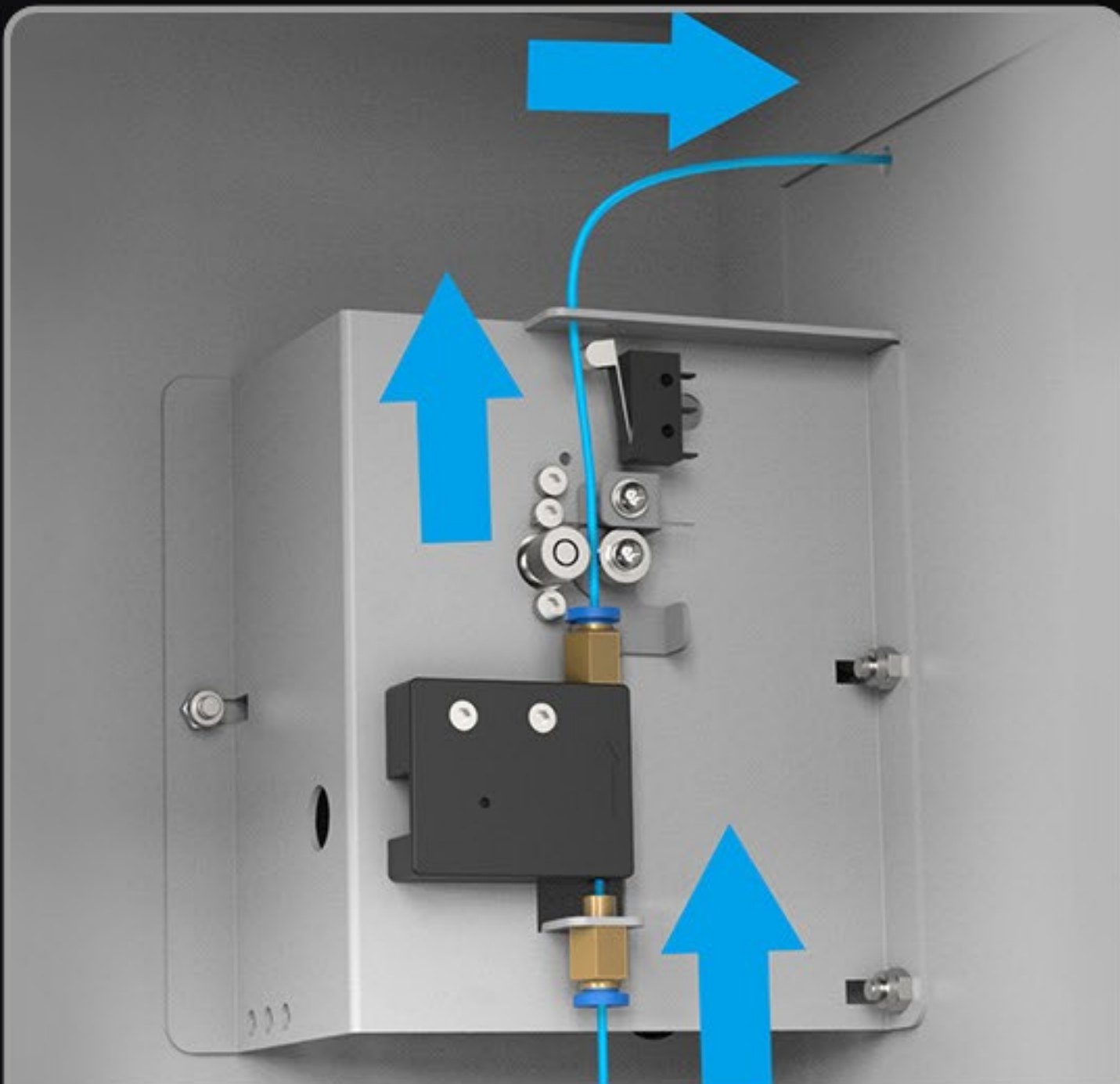

Intelligent broken material detection



Safety emergency shutdown button



# Support Printing Filament



HtPA-GF



HtPA-CF

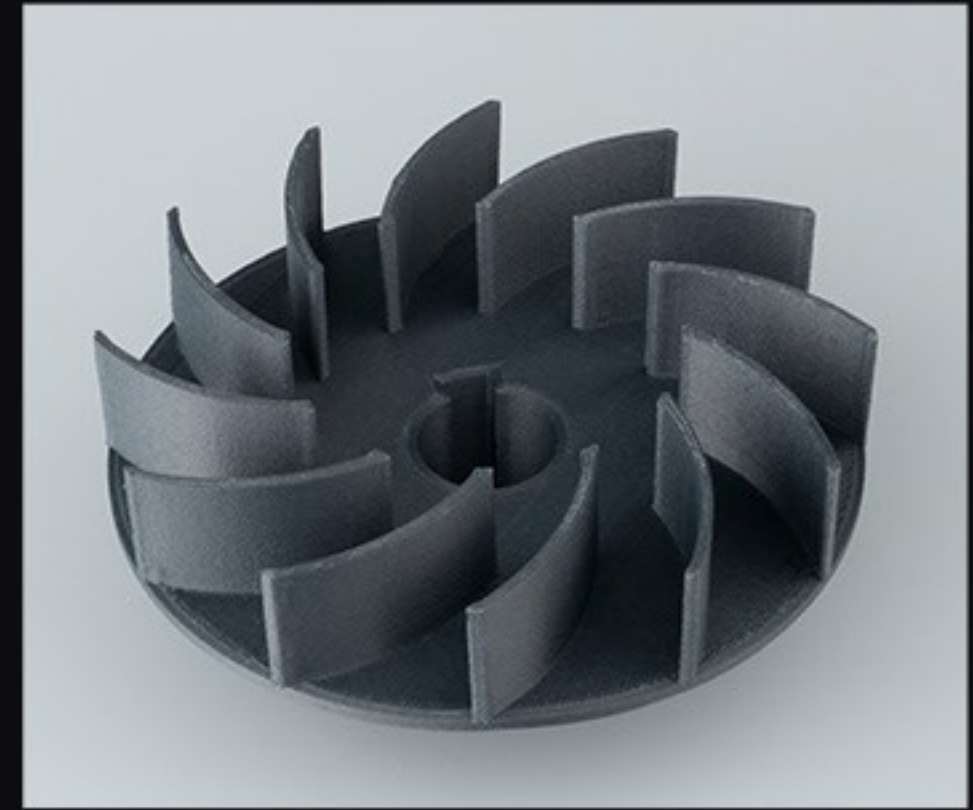

PA12-CF



PET-GF



PET-CF



PETG-ESD