

GARMIN[®]

Astro[®] 430



Owner's Manual

All rights reserved. Under the copyright laws, this manual may not be copied, in whole or in part, without the written consent of Garmin. Garmin reserves the right to change or improve its products and to make changes in the content of this manual without obligation to notify any person or organization of such changes or improvements. Go to www.garmin.com for current updates and supplemental information concerning the use of this product.

Garmin®, the Garmin logo, ANT+®, Astro®, BlueChart®, City Navigator®, and TracBack® are trademarks of Garmin Ltd. or its subsidiaries, registered in the USA and other countries. BaseCamp™ and chirp™ are trademarks of Garmin Ltd. or its subsidiaries. These trademarks may not be used without the express permission of Garmin.

Windows® is a registered trademark of Microsoft Corporation in the United States and/or other countries. Mac® is a trademark of Apple Inc., registered in the USA and other countries. microSD™ and the microSD logo are trademarks of SD-3C, LLC.

Other trademarks and trade names are those of their respective owners.

Table of Contents

Introduction	1
Setting Up the System.....	1
Device Overviews.....	1
Astro 430 Handheld Device.....	1
Keypad.....	1
Dog Collar Device.....	1
Installing Batteries.....	1
Charging the Dog Collar Device.....	1
Turning On the Devices.....	2
Turning Off the Devices.....	2
Acquiring Satellite Signals.....	2
Adjusting the Backlight Brightness.....	2
Fitting the Collar on Your Dog.....	2
Using the On-Screen Keyboard.....	2
Dog Tracking	2
Tracking Your Dog on the Map.....	2
Navigating to Your Dog.....	2
Viewing Dog Status.....	2
Dog Status Icons.....	3
Location Alerts.....	3
Setting a Geofence Alert.....	3
Setting a Radius Alert.....	3
Editing Location Alerts.....	3
Dog Information.....	3
Hunt Metrics.....	3
Resetting a Dog's Statistics and Track.....	3
Changing the Length of the Dog's Track.....	3
Changing a Dog Name.....	3
Changing the Color of the Dog's Track.....	3
Changing the Dog Type.....	3
Setting Dog Alerts.....	4
Removing a Dog.....	4
Pairing a Dog Collar to the Astro Device.....	4
Adding a Dog Using the Track and Control Codes.....	4
Assigning a Dog ID Manually.....	4
Changing the Update Rate.....	4
Communication with the Collar.....	4
Tracking with BaseCamp™ BaseStation.....	4
Waypoints, Routes, and Tracks	4
Waypoints.....	4
Marking Your Vehicle Location.....	4
Marking Your Current Location.....	5
Marking a Covey.....	5
Marking a Waypoint Using the Map.....	5
Navigating to a Waypoint.....	5
Editing a Waypoint.....	5
Moving a Waypoint on the Map.....	5
Repositioning a Waypoint to Your Current Location.....	5
Increasing the Accuracy of a Waypoint Location.....	5
Projecting a Waypoint.....	5
Deleting a Waypoint.....	5
Routes.....	5
Creating a Route.....	5
Navigating a Saved Route.....	5
Editing a Route.....	5
Viewing the Active Route.....	5
Reversing a Route.....	5
Deleting a Route.....	6
Deleting All Routes.....	6
Tracks.....	6
Recording Track Logs.....	6
Viewing the Elevation Plot of a Track.....	6
Viewing Details about the Track.....	6
Saving the Current Track.....	6
Marking a Location on a Saved Track.....	6
Navigating to the Start of a Track.....	6
Archiving a Track Manually.....	6
Sending and Receiving Data Wirelessly.....	6
Sharing Dog Information.....	6
Receiving Dog Information.....	6
Navigation	6
Map.....	6
Enabling the Map Data Fields.....	7
Compass.....	7
Calibrating the Compass.....	7
Navigating with the Bearing Pointer.....	7
Course Pointer.....	7
Find Menu.....	7
Finding a Waypoint by Name.....	7
Navigating with Sight 'N Go.....	7
Viewing the Elevation Plot.....	7
Calibrating the Barometric Altimeter.....	7
Navigating to a Point on the Plot.....	7
Changing the Plot Type.....	7
Trip Computer.....	7
Resetting the Trip Computer.....	7
Applications	8
Setting a Proximity Alarm.....	8
Calculating the Size of an Area.....	8
Viewing the Calendar and Almanacs.....	8
Setting an Alarm.....	8
Geocaches.....	8
Downloading Geocaches Using a Computer.....	8
Finding a Geocache.....	8
Filtering the Geocache List.....	8
chirp™.....	8
Opening the Stopwatch.....	8
Satellite Page.....	8
Changing the Satellite View.....	8
Turning Off GPS.....	9
Simulating a Location.....	9
Disabling Dog Data Broadcast.....	9
Enabling Bark Detection.....	9
Enabling Rescue Mode.....	9
VIRB® Remote.....	9
Customizing Your Device	9
Customizing the Main Menu.....	9
Customizing the Data Fields.....	9
Profiles.....	9
Creating a Custom Profile.....	9
Editing a Profile Name.....	9
Deleting a Profile.....	9
System Settings.....	9
Dog Settings.....	9
Display Settings.....	10
Setting the Device Tones.....	10
Map Settings.....	10
Advanced Map Settings.....	10
Tracks Settings.....	10
Changing the Units of Measure.....	10
Time Settings.....	10
Position Format Settings.....	10
Heading Settings.....	10
Altimeter Settings.....	10
Geocaching Settings.....	11
Routing Settings.....	11
Marine Map Settings.....	11
Setting up Marine Alarms.....	11

Device Information	11
Viewing Device Information.....	11
Support and Updates.....	11
Support and Updates.....	11
Updating the Software.....	11
Device Care.....	11
Cleaning the Device.....	11
Cleaning the Screen.....	11
Astro 430 Handheld Device Specifications.....	12
T5 Dog Collar Device Specifications.....	12
T5 mini Dog Collar Device Specifications.....	12
Battery Information.....	12
Long-Term Storage.....	12
Data Management.....	12
File Types.....	12
Installing a Memory Card.....	12
Connecting the Handheld Device to a Computer.....	12
Connecting the Collar to a Computer.....	13
Transferring Dog Tracks to BaseCamp.....	13
Deleting Files.....	13
Disconnecting the USB Cable.....	13
Appendix	13
Accessories and Replacement Parts.....	13
Purchasing Accessories.....	13
Dog Device Battery Replacement Instructions.....	14
Replacing the T5 mini Dog Collar Device Battery.....	14
Replacing the Collar Strap.....	15
VHF Radio Information.....	15
Replacing the VHF Antenna in the Handheld Device.....	15
Replacing the VHF Antenna in the Dog Collar Device.....	15
Changing the Fuse in the Vehicle Power Cable.....	15
Data Fields.....	15
Troubleshooting.....	16
My handheld device is not responding.....	16
My dog collar devices have conflicting IDs.....	16
My handheld device does not report barks.....	16
Getting More Information.....	17
Registering Your Device.....	17
Index	18

Introduction

⚠ WARNING

See the *Important Safety and Product Information* guide in the product box for product warnings and other important information.

Setting Up the System

You must set up the handheld device and the dog collar device before you can use the devices.

- 1 Install batteries in the handheld device (*Installing Batteries, page 1*).
- 2 Charge the dog collar device (*Charging the Dog Collar Device, page 1*).
- 3 Turn on the devices (*Turning On the Devices, page 2*).
- 4 If necessary, add the dog collar device to the handheld device (*Pairing a Dog Collar to the Astro Device, page 4*).
- 5 Acquire satellite signals (*Acquiring Satellite Signals, page 2*).

Device Overviews

Astro 430 Handheld Device

NOTICE

Avoid using a high-powered radio (greater than 5 watts) in close proximity to the handheld device. It may cause irreversible damage to the handheld device.



①	GPS antenna
②	VHF antenna
③	Power key
④	Display
⑤	Keypad
⑥	USB port (under weather cap)
⑦	microSD™ card slot (under battery door)
⑧	Mounting spine
⑨	Battery cover D-ring

Keypad



IN	Select to zoom in on the map.
OUT	Select to zoom out on the map.
MAP	Select to view the map.

MENU	Select to open the menu for the active page. Select twice to open the main menu.
ENTER	Select to select options and acknowledge messages.
BACK	Select to cancel data entry or return to the previous menu or page.
MARK	Select to mark your current location.
DOG	Select to view the dog tracking page.
⬆️⬇️⬆️ ⬆️⬆️⬆️	Select to view or scroll through options and to move the map pointer.

Locking the Keypad

- 1 Select .
- 2 Select **OUT**.

Dog Collar Device

NOTE: Your dog collar device may look different than the device pictured.



①	VHF antenna
②	GPS antenna
③	Power key
④	Status LED and flashing beacon LEDs

Installing Batteries

The handheld device operates on two AA batteries (not included). Use NiMH or lithium batteries for best results.

- 1 Turn the D-ring counter-clockwise, and pull up to remove the cover.
- 2 Insert two AA batteries, observing polarity.



- 3 Replace the battery cover, and turn the D-ring clockwise.
- 4 Hold .
- 5 Select **Setup > System > Battery Type**.
- 6 Select **Alkaline, Lithium, or Rechargeable NiMH**.

Charging the Dog Collar Device

NOTICE

To prevent corrosion, thoroughly dry the contacts on the collar and the surrounding area before connecting the charging clip.

NOTE: Your dog collar device may look different than the device pictured.

You should fully charge the battery before you use the device for the first time. Charging a fully depleted battery takes about five hours.

- 1 Snap the charging clip ① onto the device ②.

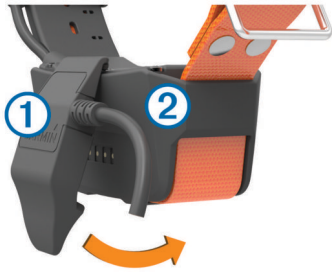

- 2 Plug the small end of the power cable into the mini-USB port on the charging clip cable.
- 3 Plug the power cable into a power source.
The status LED is solid red when the collar is charging.
- 4 After the status LED turns solid green, remove the charging clip from the collar.

Turning On the Devices

- On the handheld device, hold the power key until the LCD display turns on.
- On the dog collar device, hold the power key until the status LED flashes and the collar beeps.

Turning Off the Devices

- On the handheld device, hold the power key until the LCD screen turns off.
- On the dog collar device, hold the power key until the status LED turns red.

Acquiring Satellite Signals

Both the collar and handheld device must acquire satellite signals before you put the collar on your dog. Acquiring satellites can take a few minutes.

- 1 Go outdoors to an open area.
- 2 Turn on both devices (*Turning On the Devices, page 2*).
- 3 Select the power key on the handheld device.

▬▬▬ shows the GPS signal strength.

When the collar has acquired satellite signals, the status LED flashes a double-blink or triple-blink in green.

Adjusting the Backlight Brightness

NOTE: The backlight brightness may be limited when the battery strength is low.

Extensive use of screen backlighting can significantly reduce battery life.

- 1 Select .
- 2 Select an option:
 - To change between the preset brightness levels, select .
 - To adjust the brightness levels manually, select ◀ or ▶.
- 3 Select **ENTER**.

Fitting the Collar on Your Dog



Do not spray the device or collar with harsh chemicals including but not limited to flea or tick spray. Always ensure that any flea or tick spray that is applied to the dog is completely dry before placing the collar on the dog. Small amounts of harsh chemicals can damage the plastic components and collar laminate.

Before you can put the collar on the dog, you must pair the handheld device and collar (*Pairing a Dog Collar to the Astro Device, page 4*), and acquire satellite signals (*Acquiring Satellite Signals, page 2*).

- 1 Position the collar with the VHF whip antenna pointing up, the GPS antenna facing up, and the LEDs facing forward.
- 2 Place the collar around the middle of the dog's neck.
- 3 Tighten the strap so it is snug around the dog's neck.

NOTE: The collar should fit tightly and should not be able to rotate or slide on the dog's neck. The dog must be able to swallow food and water normally. You should observe your dog's behavior to verify the collar is not too tight.

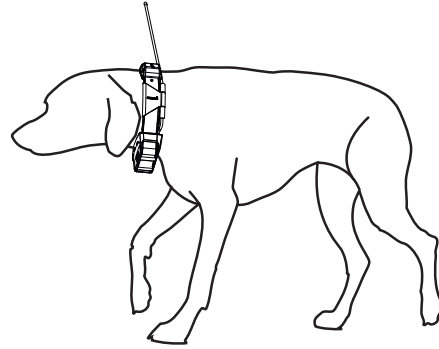

- 4 If the strap is too long, cut off the excess, leaving at least 7.62 cm (3 in.) to spare.

Using the On-Screen Keyboard

A keyboard appears when you enter text.

- Select ▲, ▼, ◀, and ▶ to select a character, and select **ENTER**.
- Select ✖ to backspace.
- Select ⬆ to shift.
- Select **IN** or **OUT** to change the character mode of the keyboard.
- Select **Done** to save the text and close the keyboard.

Dog Tracking

The handheld device allows you to track your dog, using the tracking compass or map. The map displays your location and your dog's location and tracks. The compass pointer indicates the direction of the dog's current location.

Tracking Your Dog on the Map

Before you can track a dog on the map, you must add them to the handheld device (*Pairing a Dog Collar to the Astro Device, page 4*).

You can view the dog's location on the map.

- 1 Select **MAP**.
- 2 Select **IN** and **OUT** to zoom in and out of the map.

Navigating to Your Dog

- 1 Select **Dog List**.
- 2 Select the dog.
- 3 Select **Show Info > Go**.
The map opens.
- 4 Follow the magenta line to the dog.





Viewing Dog Status

You can view your dog's status, such as the direction and distance to the dog from the handheld device. To determine if

your dog is barking, you must first enable bark detection ([Enabling Bark Detection, page 9](#)).

- 1 From the main menu, select **DOG** to view the dog tracking page.
- 2 If you have additional dogs, scroll through the list to find the dog.
The handheld device can track up to 20 dogs.
- 3 Select **ENTER**.

Dog Status Icons

	Sitting
	Running
	On point
	Treed
	Unknown*

*The unknown status icon indicates that the collar has not acquired a satellite signal and that the handheld device cannot determine the location of the dog.

Location Alerts

Location alerts notify you when your dogs enter or exit a particular location. You can create a custom geofence or use a radius around your current location.

A geofence is an invisible boundary around an area and is created using points on the map. The virtual boundaries of a geofence are accurate up to approximately 3 m (10 ft.). Geofences perform best when sized to cover an area encompassing an average sized backyard (approximately ¼ acre).

Setting a Geofence Alert

- 1 Select **Setup > Location Alerts > Add Alert > Geofence**.
- 2 On the map, select a point for the first corner of the geofence, and select **ENTER**.
- 3 Select additional points to define the geofence boundary.
You must select at least 3 points, and you can select up to 10 points.
- 4 Select **BACK**.

Setting a Radius Alert

You can receive an alert when a dog or contact moves within or beyond a specified distance from you.

- 1 Select **Setup > Location Alerts > Add Alert > Radius**.
- 2 Select the unit of measurement.
- 3 Enter the radius distance, and select **Done**.

Editing Location Alerts

- 1 Select **Setup > Location Alerts**.
- 2 Select an alert.
- 3 Select an option:
 - Select **Disable** to turn off notifications for this alert.
 - Select **Set Alert Type** to set the way the device notifies you for this alert.
 - Select **Set Alert Mode** to set the notification to sound on exit, entrance, or both.
 - Select **Delete** to remove the alert.

Dog Information

The handheld device assigns a default name, "Dog," to the dog collar device if it was packaged with the handheld device.

Hunt Metrics

Hunt metrics provides a collection of data that helps you understand the hunting patterns and behaviors of your dog. The hunt metrics reset automatically at the beginning of each new hunt.

Data Fields

Barks: The number of times the dog barks during the hunt. Bark alerts are triggered by low intensity level barks. This data field requires bark detection to be enabled ([Enabling Bark Detection, page 9](#)).

NOTE: This feature is not available in all areas.

Bays: The number of times the dog bays during the hunt. Bay alerts are triggered by high intensity level barks. This data field requires bark detection to be enabled ([Enabling Bark Detection, page 9](#)).

NOTE: This feature is not available in all areas.

Distance: The total distance the dog traveled.

Dog Score: A combination of metrics that indicates how well a dog performed on a hunt.

On Point: The number of times and the locations where the dog pointed during the hunt.

Time: The amount of time the dog was afield.

Treed: The number of times and locations where the dog treed during the hunt.

Resetting a Dog's Statistics and Track

You might want to clear the dog statistics and track before a new hunt.

- 1 Select **Dog List**.
- 2 Select a dog.
- 3 Select **Show Info > Reset > Yes**.

Changing the Length of the Dog's Track

You can adjust the length of time the dog track appears on the map. Reducing the duration of the track can reduce the clutter on the map. Changing the map does not affect the tracks stored in the handheld device.

- 1 Select **Setup > Dogs > Dog Track Length on Map**.
- 2 Select an option.
- 3 Select **Map**.

Changing a Dog Name

- 1 Select **DOG > ENTER**.
The dog information appears.
- 2 Select the name field.
The on-screen keyboard appears ([Using the On-Screen Keyboard, page 2](#)).
- 3 Enter the name of the dog.

Changing the Color of the Dog's Track

You can change the track color of the dog. It is helpful to have the track color match the color of the collar strap, if possible.

- 1 Select **Dog List**.
- 2 Select a dog.
- 3 Select **Show Info**.
- 4 Select the colored square next to the dog's name.
- 5 Select a color.

Changing the Dog Type

Before you can change the dog type, you must turn on the dog collar device and bring it within 3 m (10 ft.) of the handheld device.

You can assign a dog type so the appropriate dog status symbols appear.

1 Select **DOG > ENTER > MENU**.

2 Select **Change Dog Type**.

3 Select a type.

Setting Dog Alerts

You can adjust how the handheld device alerts you to certain actions of the dog.

1 Select **Setup > Dogs > Dog Alerts**.

2 Select an action.

3 Select the method the device uses to alert you for this action.

4 Repeat steps 2 and 3 as needed.

Removing a Dog

1 Select **Dog List**.

2 Select a dog.

3 Select **Remove**.

Pairing a Dog Collar to the Astro Device

Before you can pair devices to the handheld device, the handheld device must be close enough to the dog collar device to touch it.

The handheld device can track up to 20 dogs with dog collar devices. If you purchase additional dog collar devices, you can link them to the handheld device.

1 Select **DOG**.

2 Select **Add Dog**.

3 Turn off the dog collar device.

4 Follow the on-screen instructions.

By default, the new dog is named "Dog" and an ID number is randomly assigned.

An error message could appear if there is a conflict with the ID number of another dog.

After pairing is complete, you can add the dog collar device to additional handheld devices using the dog collar device track code or control code.

Adding a Dog Using the Track and Control Codes

NOTE: This feature varies based on dog collar device type and feature availability in your area.

Before you can add a dog using the track and control codes, the dog owner must find the track and control codes ([Finding the Dog ID and Track and Control Codes, page 4](#)) and tell them to you.

You can use track and control codes to authorize a handheld device to interact with your dog collar device. If you are not near the dog you want to add or you cannot put the collar into pairing mode, you can add the dog using the track and control codes.

1 Select **DOG > Add Dog**.

2 When asked if you are near the collar, select **No**.

3 When asked if you know the track and control codes, select **Yes**.

4 Enter the track or control code for the collar, and select **Done**.

The dog's track code allows you to track the dog. The dog's control code allows you to both track the dog and access the collar settings.

5 Enter the name of the dog, and select **Done > OK**.

Finding the Dog ID and Track and Control Codes

You can share a dog's track code so another person can track your dog. Also, you can share a dog's control code so another person can track your dog and access the collar settings.

1 Select **Dog List**.

2 Select a dog.

3 Select **Show Info**.

Assigning a Dog ID Manually

Before you can assign a dog ID manually, you must turn on the dog collar device and bring it within 3 m (10 ft.) of the handheld device. You must assign a new ID number to the dog.

1 Select **DOG**.

2 Select a dog.

3 Select **Show Info > MENU > Change ID**.

4 Select an unassigned and nonconflicting ID.

Changing the Update Rate

You can select a longer duration for the update rate to conserve battery power. The 30-second and 2-minute rates reduce battery drain, but they record less-detailed dog tracks and statistics.

1 Bring the handheld device within a few feet of the dog collar device.

2 Select **DOG**.

3 Select a dog.

4 Select **Show Info > MENU > Change Update Rate**.

5 Select an update rate.

Communication with the Collar

You should keep an unobstructed line of sight between your handheld device and the dog collar device to produce the best communication signal. To achieve the best line-of-sight conditions, you should move to the highest elevation point in your area (for example, on the top of a hill).

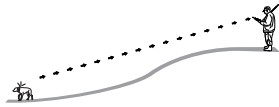
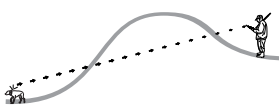
Best	
Good	
Poor	

Tracking with BaseCamp™ BaseStation

Before you can track your dogs using BaseCamp, you must download BaseCamp to your computer (www.garmin.com/basecamp).

The BaseStation feature of BaseCamp allows you to track your dogs in real-time on a computer. For more information on using BaseCamp, see the help file in the application.

1 Select **Setup > System > BaseCamp Basestation > Prompted**.

2 Open BaseCamp.

3 Follow the on-screen instructions.

Waypoints, Routes, and Tracks

Waypoints

Waypoints are locations you record and store in the device. Waypoints can mark where you are, where you are going, or where you have been. You can add details about the location, such as name, elevation, and depth.

Marking Your Vehicle Location

You can mark the location of your vehicle so you can navigate back to your vehicle after a hunt.

- 1 From the main menu, select **MARK**.
- 2 Follow the on-screen instructions.

Marking Your Current Location

- 1 Select **MARK**.
- 2 Select an option:
 - Select **New**.
 - Select a default location name, such as **Truck** or **Camp**.
- 3 Edit the location information (optional).
- 4 Select **Done**.

Marking a Covey

You can mark a covey location and enter the estimated number of birds flushed and the number of birds taken.

- 1 Select **MARK > Covey**.
- 2 Enter the number of birds flushed, the number of birds taken, and select **OK**.
- 3 Review and edit location information (optional).
- 4 Select **Done**.

Marking a Waypoint Using the Map

- 1 Select **MAP**.
- 2 Select a location on the map.
- 3 Select **ENTER > MENU > Save as Waypoint**.

Navigating to a Waypoint

- 1 From the main menu, select **Tools > Find > Waypoints**.
- 2 Select a waypoint.
- 3 Select **Go**.

Editing a Waypoint

Before you can edit a waypoint, you must create a waypoint.

- 1 From the main menu, select **Tools > Waypoint Mgr..**
- 2 Select a waypoint.
- 3 Select an item to edit, such as the name.
- 4 Enter the new information.

Moving a Waypoint on the Map

- 1 From the main menu, select **Tools > Waypoint Mgr..**
- 2 Select a waypoint.
- 3 Select **MENU > Move Waypoint**.
- 4 Select a location on the map.
- 5 Select **ENTER**.

Repositioning a Waypoint to Your Current Location

You can change the position of a waypoint. For example, if you move your vehicle, you can change the location to your current position.

- 1 Select **Tools > Waypoint Mgr..**
- 2 Select a waypoint.
- 3 Select **MENU > Reposition Here**.

The waypoint position changes to your current location.

Increasing the Accuracy of a Waypoint Location

You can refine a waypoint location for more accuracy. When averaging, the device takes several readings at the same location and uses the average value to provide more accuracy.

- 1 Select **Tools > Waypoint Mgr..**
- 2 Select a waypoint.
- 3 Select **MENU > Average Location**.
- 4 Move to the waypoint location.
- 5 Select **Start**.
- 6 Follow the on-screen instructions.

- 7 When the confidence status bar reaches 100%, select **Save**.
For best results, collect 4 to 8 samples for the waypoint, waiting at least 90 minutes between samples.

Projecting a Waypoint

You can create a new location by projecting the distance and bearing from a marked location to a new location.

- 1 From the main menu, select **Tools > Waypoint Mgr..**
- 2 Select a waypoint.
- 3 Select **MENU > Project Waypoint**.
- 4 Follow the on-screen instructions.
- 5 Select an option:
 - To save the waypoint information, select **Save**.
 - To save and edit the waypoint information, select **Save and Edit**.

Deleting a Waypoint

- 1 From the main menu, select **Tools > Waypoint Mgr..**
- 2 Select a waypoint.
- 3 Select **MENU > Delete > Yes**.

Routes

A route is a sequence of waypoints or locations that leads you to your final destination.

Creating a Route

- 1 Select **Tools > Route Planner > Create Route > Select First Point**.
- 2 Select a category.
- 3 Select the first point on the route.
- 4 Select **Use > Select Next Point**.
- 5 Select a point.
- 6 Repeat steps 3 through 5 to add all the points in the route.

Navigating a Saved Route

- 1 Select **Tools > Route Planner**.
- 2 Select a route.
- 3 Select **View Map > Go**.
- 4 Navigate using the compass ([Navigating with the Bearing Pointer, page 7](#)) or map ([Map, page 6](#)).

Editing a Route

- 1 Select **Tools > Route Planner**.
- 2 Select a route.
- 3 Select **Edit Route**.
- 4 Select a point.
- 5 Select an option:
 - To view the point on the map, select **Review**.
 - To change the order of the points on the route, select **Move Up** or **Move Down**.
 - To insert an additional point on the route, select **Insert**.
The additional point is inserted before the point you are editing.
 - To remove the point from the route, select **Remove**.

Viewing the Active Route

- 1 Select **Tools > Active Route**.
- 2 Select a point in the route to view additional details.

Reversing a Route

- 1 Select **Tools > Route Planner**.
- 2 Select a route.
- 3 Select **Reverse Route**.

Deleting a Route

- 1 Select **Tools > Route Planner**.
- 2 Select a route.
- 3 Select **Delete Route > Yes**.

Deleting All Routes

- 1 From the main menu, select **Tools > Route Planner**.
- 2 Select **MENU > Delete All > Yes**.

Tracks

A track is a recording of your path. The track log contains information about points along the recorded path, including time, location, and elevation for each point.

Recording Track Logs

- 1 From the Main Menu, select **Setup > Tracks > Track Log**.
- 2 Select **Record, Do Not Show** or **Record, Show On Map**.
If you select **Record, Show On Map**, a line on the map indicates your track.
- 3 Select **Record Method**.
- 4 Select an option:
 - To record tracks at a variable rate that creates an optimum representation of your tracks, select **Auto**.
 - To record tracks at a specified distance, select **Distance**.
 - To record tracks at a specified time, select **Time**.
- 5 Select **Recording Interval**.
- 6 Complete an action:
 - If you selected **Auto** for the **Record Method**, select an option to record tracks more or less often.

NOTE: Using the Most Often interval provides the most track detail, but fills up the device memory quicker.

- If you selected **Distance** or **Time** for the **Record Method**, enter a value.

As you move with the device turned on, a track log is created.

Viewing the Elevation Plot of a Track

- 1 Select **Tools > Track Manager**.
- 2 Select a track.
- 3 Select **Elevation Plot**.

Viewing Details about the Track

- 1 Select **Tools > Track Manager**.
- 2 Select a track.
- 3 Select **View Map**.
The beginning and the end of the track are marked by flags.
- 4 Select the information bar at the top of the screen.
Information about the track appears.

Saving the Current Track

- 1 Select **Tools > Track Manager**.
- 2 Select a track.
- 3 Select an option:
 - To save the entire track, select **Save Track**.
 - To save part of the track, select **Save Portion**, and select the part to save.

Marking a Location on a Saved Track

- 1 From the main menu, select **Tools > Track Manager**.
- 2 Select a track.
- 3 Select **View Map**.
- 4 Select a location on the track.
- 5 Select **MARK > New**.

- 6 Edit the location information (optional).

Navigating to the Start of a Track

You can navigate back to the beginning of a track. This can be helpful when finding your way back to camp or the trail head.

- 1 Select **Tools > Track Manager > Current Track > View Map**.
- 2 Select **TracBack**.
The map page opens with your route marked with a magenta line.
- 3 Navigate using the map ([Map, page 6](#)) or the compass ([Navigating with the Bearing Pointer, page 7](#)).

Archiving a Track Manually

You can archive saved tracks to save memory space.

- 1 Select **Tools > Track Manager**.
- 2 Select a track.
- 3 Select **Archive**.

Archiving Tracks Automatically

- 1 Select **Setup > Tracks > Auto Archive**.
- 2 Select an option.

Sending and Receiving Data Wirelessly

Before you can share data wirelessly, you must be within 3 m (10 ft.) of a compatible Garmin® device.

You can share waypoints, geocaches, routes, and tracks wirelessly.

- 1 Select **Tools > Share Wirelessly**.
- 2 Select **Send** or **Receive**.
- 3 Follow the on-screen instructions.

Sharing Dog Information

Before you can share dog information with another handheld device user, the user must enable their handheld device to receive wirelessly and bring it within range of the sending device and dog collar device.

- 1 From the dog list page, select **DOG**.
- 2 Select a dog.
- 3 Select **Share Wirelessly**.
- 4 Select an option:
 - To share the dog's track only, select **Track Only**.
 - To share the dog's track and the collar's settings, select **Track and Control**.

Your device sends the dog name, unit ID, and update rate information.

Receiving Dog Information

From the dog tracking page, select **DOG > MENU > Receive Wirelessly**.

Navigation

You can navigate routes and tracks, to a waypoint, geocache, photo, or any saved location in the device. You can use the map or the compass to navigate to your destination.

Map

▲ represents your location on the map. As you travel, the icon moves and leaves a track log (trail). Waypoint names and symbols appear on the map. When you are navigating to a destination, your route is marked with a magenta line on the map.

When the map orientation is Track Up, objects on the map appear to rotate around your position. As you travel, the entire

map reorients in the direction you are facing. You can stabilize the objects by setting the orientation to North Up ([Map Settings, page 10](#)).

To open the map, select MAP.

Enabling the Map Data Fields

- 1 Select **MAP > MENU > Setup Map > Data Fields**.
- 2 Select an option.

Compass

The handheld device has a 3-axis, tilt-compensated compass. You can use a bearing pointer or a course pointer to navigate to your destination.

Calibrating the Compass

NOTE: You must calibrate the electronic compass outdoors. Do not stand near objects that influence magnetic fields, such as cars, buildings, or overhead power lines.

The device has a 3-axis electronic compass. You should calibrate the compass after moving long distances, experiencing temperature changes, or changing the batteries.

- 1 Select **DOG > MENU**.
- 2 Select **Calibrate Compass > Start**.
- 3 Follow the on-screen instructions.

Navigating with the Bearing Pointer

When navigating to a destination, ▲ points to your destination, regardless of the direction you are moving.

- 1 While navigating to a destination, select **Tools > Compass**
- 2 Turn until ▲ points toward the top of the compass, and continue moving in that direction to the destination.

Course Pointer

The course pointer is most useful if you are navigating on water or where there are no major obstacles in your path. It can also help you avoid hazards near the course, such as shoals or submerged rocks.

To enable the course pointer, from the compass, select **MENU > Setup Heading > Go To Line (Pointer)**.



The course pointer ① indicates your relationship to the course line leading to the destination. The course deviation indicator (CDI) ② provides the indication of drift (right or left) from the course. The scale ③ refers to the distance between dots ④ on the course deviation indicator, which tell you how far off course you are.

Find Menu

You can use the find menu to search for waypoints, cities, and coordinates. You can download and navigate to photos, tracks, and geocaches. Additional categories appear if you have optional, compatible detailed maps loaded on the device. When you open a category, the list contains items near your current location or the map pointer (if active).

Finding a Waypoint by Name

- 1 From the main menu, select **Tools > Find > Waypoints > MENU > Spell Search**.
- 2 Enter the name.

Matches appear as you select characters in the name.

- 3 Select the waypoint.

Finding a Waypoint Near Another Waypoint

- 1 From the main menu, select **Tools > Waypoint Mgr..**
- 2 Select a waypoint.
- 3 Select **MENU > Find Near Here**.
- 4 Select a category.

The list includes waypoints near the original waypoint.

Navigating with Sight 'N Go

You can point the device at an object in the distance, lock in the direction, and navigate to the object.

- 1 Select **Tools > Sight 'N Go**
- 2 Point the device at an object.
- 3 Select **Lock Direction > Set Course**.
- 4 Navigate using the compass ([Navigating with the Bearing Pointer, page 7](#)) or map ([Map, page 6](#)).

Viewing the Elevation Plot

By default, the elevation plot displays the elevation for an elapsed time. You can customize the plot ([Changing the Plot Type, page 7](#)) and the data fields ([Customizing the Data Fields, page 9](#)).

Select **Tools > Elevation Plot**.

Calibrating the Barometric Altimeter

You can calibrate the barometric altimeter manually if you know the correct elevation or the correct barometric pressure.

- 1 Go to a location where the elevation or barometric pressure is known.
- 2 Select **Tools > Elevation Plot > MENU > Calibrate Altimeter**.
- 3 Follow the on-screen instructions.

Navigating to a Point on the Plot

- 1 Select **Tools > Elevation Plot**.
- 2 Select a point on the plot.
Details about the point appear in the upper-left corner of the plot.
- 3 Select **MENU > View Map**.
- 4 Select the information bar at the top of the screen.
- 5 Select **Go**.
- 6 Navigate using the compass ([Navigating with the Bearing Pointer, page 7](#)) or map ([Map, page 6](#)).

Changing the Plot Type

You can change the elevation plot to display pressure and elevation over time or distance.

- 1 Select **Tools > Elevation Plot > MENU > Change Plot Type**.
- 2 Select an option.

Trip Computer

The trip computer displays your current speed, average speed, maximum speed, trip odometer, and other helpful statistics. You can customize the trip computer layout, dashboard, and data fields ([Customizing the Data Fields, page 9](#)).

To open the trip computer, select **Tools > Trip Computer**.

Resetting the Trip Computer

For accurate trip information, you can reset the trip information before beginning a trip.

- 1 Select **Tools > Trip Computer**.

- 2 Select **MENU > Reset > Reset Trip Data**.

Applications

Setting a Proximity Alarm

Proximity alarms alert you when you or your dogs are within a specified range of a particular location. A tone sounds when you enter the designated radius.

- 1 Select **Tools > Proximity Alarms**.
- 2 Select **Create Alarm**.
- 3 Select a category.
- 4 Select a location.
- 5 Select **Use**.
- 6 Enter a radius.

When you enter an area with a proximity alarm, the device sounds a tone.

Calculating the Size of an Area

- 1 Select **Tools > Area Calculation > Start**.
- 2 Walk around the perimeter of the area you want to calculate.
- 3 When finished, select **Calculate**.

Viewing the Calendar and Almanacs

You can view device activity, such as when a waypoint was saved, and almanac information for the sun and moon, and hunting and fishing.

- 1 Select **Tools**.
- 2 Select an option:
 - To view device activity for specific days, select **Calendar**.
 - To view the sunrise, sunset, moonrise, and moonset times, select **Sun and Moon**.
 - To view the predicted best times for hunting and fishing, select **Hunt and Fish**.
- 3 If necessary, select ◀ or ▶ to view a different day.

Setting an Alarm

- 1 Select **Tools > Alarm Clock**.
- 2 Enter the time.
- 3 Select **Turn Alarm On**.
- 4 Select an option.

The alarm sounds at the selected time. If the device is off at the alarm time, the device turns on and sounds the alarm.

Geocaches

Geocaching is a treasure hunting activity in which players hide or search for hidden caches using clues and GPS coordinates.

Downloading Geocaches Using a Computer

You can load geocaches manually onto your device using a computer (*Connecting the Handheld Device to a Computer*, page 12). You can place the geocache files into a GPX file and import them into the GPX folder on the device. With a premium membership to geocaching.com, you can use the "pocket query" feature to load a large group of geocaches onto your device as a single GPX file.

- 1 Connect the device to your computer using a USB cable.
- 2 Go to www.geocaching.com/play.
- 3 If necessary, create an account.
- 4 Sign in.
- 5 Follow the instructions at geocaching.com to find and download geocaches to your device.

Finding a Geocache

Before you can navigate to a geocache, you must have one or more geocaches loaded on your device.

- 1 From the main menu, select **Tools > Geocaches**.
- 2 Select a geocache.
- 3 Select **Go**.

When a geocache is found, the handheld device marks the cache as found, logs an entry into the calendar, and shows the nearest cache.

Filtering the Geocache List

You can filter your geocache list based on certain factors, such as the level of difficulty.

- 1 From the main menu, select **Tools > Find > Geocaches > MENU > Apply Filter > Quick Filter**.
- 2 Select items to filter.
- 3 Select **Search**.

Editing a Custom Geocache Filter

- 1 Select **Setup > Geocaches > Filter Setup**.
- 2 Select a filter.
- 3 Select an item to edit.

Creating and Saving a Geocache Filter

You can create and save custom filters for geocaches based on specific factors. After you set up the filter, you can apply it in the geocaches list.

- 1 Select **Setup > Geocaches > Filter Setup > Create Filter**.
- 2 Select items to filter.
- 3 Select an option:
 - To apply the filter to the geocache list, select **Search**.
 - To save the filter, select **BACK**. After it is saved, the filter is automatically named. You can access the custom filter from the geocaches list.

chirp™

A chirp is a small Garmin accessory that is programmed and left in a geocache. You can use your device to find a chirp in a geocache. For more information about the chirp, see the *chirp Owner's Manual* at www.garmin.com.

Enabling chirp Searching

- 1 Select **Setup > Geocaches**.
- 2 Select **chirp Searching > On**.

Finding a Geocache with a chirp

- 1 From the main menu, select **Tools > Find > Geocaches > MENU > Show chirp Details > Go**.
- 2 Begin navigating to a geocache.

When you are within 10 m (33 ft.) of the geocache that contains a chirp device, details about the chirp device appear.
- 3 If available, select **Go** to navigate to the next stage of the geocache.

Opening the Stopwatch

Select **Tools > Stopwatch**.

Satellite Page

The satellite page shows your current location, GPS accuracy, satellite locations, and signal strength.

Changing the Satellite View

The default satellite view has north at the top of the screen. You can change the orientation of the satellite view to place your current track toward the top of the screen.

- 1 Select **Tools > Satellite**.

- 2 Select **MENU** > **Track Up**.

Turning Off GPS

- 1 Select **Tools** > **Satellite**.
- 2 Select **MENU** > **Use With GPS Off**.

Simulating a Location

Before you can simulate a location, you must turn off GPS.

- 1 Select **Tools** > **Satellite**.
- 2 Select **MENU** > **Set Location On Map**.
- 3 Select a location.
- 4 Select **Use**.

Disabling Dog Data Broadcast

By default, the handheld device broadcasts dog data to compatible devices. You can disable data broadcasting to keep your data from being seen on other compatible devices. See the owner's manual for your compatible device for more information.

Select **Setup** > **Dogs** > **Broadcast Dog Data** > **Off**.

Enabling Bark Detection

NOTE: This feature is not available in all areas.

Select **Setup** > **Dogs** > **Bark Detection**.

A barking icon appears on the dog tracking page and the map page.

When the dog collar device is active and properly fitted on the dog (*Fitting the Collar on Your Dog, page 2*), it detects barks automatically. After bark detection is enabled, you can set up a bark alert (*Setting Dog Alerts, page 4*).

Enabling Rescue Mode

Before you can enable rescue mode, you must turn on the dog collar device and bring it within 3 m (10 ft.) of the handheld device.

If you are concerned about your dog becoming lost and running the battery down, you can enable rescue mode. Rescue mode extends the battery life of the collar to allow for more time to locate the dog. You can preserve the battery life of your dog collar device by enabling a low power, battery-saving mode from your handheld device. This reduces the frequency that the collar updates its position to the handheld device.

- 1 From the dog tracking page, select a dog.
The dog information page appears.
- 2 Select **MENU** > **Rescue Mode**.
- 3 Wait until the confirmation message appears before you release your dog.

VIRB® Remote

The VIRB remote function allows you to control your VIRB action camera using your device. Go to www.garmin.com/VIRB to purchase a VIRB action camera.

Customizing Your Device

Customizing the Main Menu

You can move, add, and delete items in the main menu.

- 1 From the main menu, select **MENU** > **Change Item Order**.
- 2 Select a menu item.
- 3 Select an option:
 - Select **Move** to change the placement of the item in the list.
 - Select **Insert** to add a new item to the list.
 - Select **Remove** to delete an item from the list.

Customizing the Data Fields

Before you can customize the data fields on the map, you must enable the data fields (*Enabling the Map Data Fields, page 7*).

You can customize the data fields and dashboards of the map, compass, elevation plot, and trip computer.

- 1 Open the page for which you will change the data fields.
- 2 Select **MENU** > **Change Data Fields**.
- 3 Select a data field to customize.
- 4 Select the new data field.

For data field descriptions, see *Data Fields, page 15*.

Profiles

Profiles are a collection of settings that optimize your device based on how you are using it. For example, the settings and views are different when you use the device for hunting than when geocaching.

Profiles are associated with the activity screens, including the home screen.

When you are using a profile and you change settings, such as data fields or units of measurement, the changes are saved automatically as part of the profile.

Creating a Custom Profile

You can customize your settings and data fields for a particular activity or trip.

- 1 From the main menu, select **Tools** > **Profile Change**.
- 2 Select **MENU** > **Setup Profiles** > **Create Profile** > **OK**.
- 3 Customize the settings as necessary.
- 4 Customize the data fields as necessary.

Any changes you make to the settings, dashboards, and data fields are automatically saved to the active profile.

Editing a Profile Name

- 1 From the main menu, select **Tools** > **Profile Change** > **MENU** > **Setup Profiles**.
- 2 Select a profile.
- 3 Select **Edit Name**.
- 4 Enter the new name.

Deleting a Profile

- 1 From the main menu, select **Tools** > **Profile Change** > **MENU** > **Setup Profiles**.
- 2 Select a profile.
- 3 Select **Delete**.

System Settings

Select **Setup** > **System**.

GPS: Sets the GPS to Normal, WAAS/EGNOS (Wide Area Augmentation System/European Geostationary Navigation Overlay Service), or Demo Mode (GPS off). For more information about WAAS, go to www.garmin.com/aboutGPS/waas.html.

Language: Sets the text language on the device.

NOTE: Changing the text language does not change the language of user-entered data or map data, such as street names.

Battery Type: Allows you to select the type of AA battery you are using.

BaseCamp Basestation: Sets how the device connects to BaseCamp when the device is connected to the computer.

Dog Settings

Select **Setup** > **Dogs**.

Dog Track Length on Map: Sets the length of time the dog track appears on the map. Reducing the duration of the track can reduce the clutter on the map.

Zoom Map To Dogs: Automatically zooms the map to show all of the dogs' locations and your location unless you manually pan the map. This feature can help you locate your dogs quickly.

Broadcast Dog Data: Automatically sends dog data to compatible devices ([Disabling Dog Data Broadcast, page 9](#)).

Dog Alerts: Sets how you are alerted to certain actions ([Setting Dog Alerts, page 4](#)).

Bark Detection: Enables your device to detect barks.
NOTE: This feature is not available in all areas.

Display Settings

Select **Setup > Display**.

Backlight Timeout: Adjusts the length of time before the backlight turns off.

Battery Save: Saves the battery power and prolongs the battery life by turning off the screen when the backlight times out.

Screen Capture: Allows you to save the image on the device screen.

Colors: Changes the appearance of the display background and selection highlight.

Setting the Device Tones

You can customize tones for messages, keys, warnings, and alarms.

- 1 Select **Setup > Tones**.
- 2 Select a tone for each audible type.

Map Settings

Select **Setup > Map**.

Orientation: Adjusts how the map is shown on the page. North Up shows north at the top of the page. Track Up shows a top-down view with your current direction of travel toward the top of the page. Automotive Mode shows a 3D automotive view with the direction of travel at the top.

Guidance Text: Sets when the guidance text appears on the map.

Data Fields: Customizes the data fields and dashboards of the map, compass, elevation plot, and trip computer.

Map Information: Enables or disables the maps currently loaded on the device.

Advanced Map Settings

Select **Setup > Map > Advanced Map Setup**.

Auto Zoom: Automatically selects the appropriate zoom level for optimal use on your map. When Off is selected, you must zoom in or out manually.

Zoom Levels: Adjusts the zoom level at which map items will appear. The map items will not appear when the map zoom level is higher than the selected level.

Text Size: Selects the text size for map items.

Detail: Selects the amount of detail shown on the map. Showing more detail may cause the map to redraw more slowly.

Shaded Relief: Shows detail relief on the map (if available) or turns off shading.

Tracks Settings

Select **Setup > Tracks**.

Track Log: Turns track recording on or off.

Record Method: Sets a track recording method. Auto records the tracks at a variable rate to create an optimum representation of your tracks.

Recording Interval: Sets a track log recording rate. Recording points more frequently creates a more-detailed track, but fills the track log faster.

Auto Archive: Sets an automatic archive method to organize your tracks. Tracks are saved and cleared automatically.

Color: Changes the color of the track line on the map.

Changing the Units of Measure

You can customize units of measure for distance and speed, elevation, depth, temperature, and pressure.

- 1 Select **Setup > Units**.
- 2 Select a measurement type.
- 3 Select a unit of measure for the setting.

Time Settings

Select **Setup > Time**.

Time Format: Sets the device to show time in a 12-hour or 24-hour format.

Time Zone: Sets the time zone for the device. Automatic sets the time zone automatically based on your GPS position.

Position Format Settings

NOTE: Do not change the position format or the map datum coordinate system unless you are using a map or chart that specifies a different position format.

Select **Setup > Position Format**.

Position Format: Sets the position format for the location information.

Map Datum: Sets the coordinate system on which the map is structured.

Map Spheroid: Shows the coordinate system the device is using. The default coordinate system is WGS 84.

Heading Settings

You can customize the compass settings.

Select **Setup > Heading**.

Display: Sets the type of directional heading shown on the compass.

North Reference: Sets the north reference used on the compass.

Go To Line (Pointer): Sets the behavior of the pointer that appears on the map. Bearing points in the direction of your destination. Course shows your relationship to the course line leading to the destination.

Compass: Automatically switches from an electronic compass to a GPS compass when you are traveling at a higher rate of speed for a period of time.

Calibrate Compass: Calibrates the compass ([Calibrating the Compass, page 7](#)).

Altimeter Settings

Select **Setup > Altimeter**.

Auto Calibration: Automatically calibrates the altimeter each time the device is turned on.

Barometer Mode: Sets how the device measures barometric information. Variable Elevation allows the barometer to measure changes in elevation while you are moving. Fixed Elevation assumes the device is stationary at a fixed elevation, so the barometric pressure should change only due to weather.

Pressure Trending: Sets how the device records pressure data. Save Always records all pressure data, which can be helpful when you are watching for pressure fronts.

Plot Type: Sets the type of data recorded and displayed in the plot. Records elevation changes over a period of time or distance, records barometric pressure over a period of time, or records ambient pressure changes over a period of time.

Calibrate Altimeter: Calibrates the altimeter.

Geocaching Settings

Select **Setup > Geocaches**.

Geocache List: Allows you to display the geocache list by names or codes.

Found Geocaches: Allows you to edit the number of geocaches found. This number automatically increases as you log a find.

Filter Setup: Allows you to create and save custom filters for geocaches based on specific factors (*Creating and Saving a Geocache Filter*, page 8).

chirp Searching: Allows the device to search for a geocache containing a chirp accessory (*Enabling chirp Searching*, page 8).

Program chirp: Programs the chirp accessory. See the *chirp owner's manual* at www.garmin.com.

Routing Settings

The device calculates routes optimized for the type of activity you are doing. The routing settings available vary based on the activity selected.

Select **Setup > Routing**.

Guidance Method: Sets the preference for optimizing route calculation based on distance, time, on-road, or off-road routing.

Calculate Routes for: Sets the mode of transportation for which to calculate routes.

Lock On Road: Locks the position icon, which represents your position on the map, onto the nearest road.

Off Road Transitions: Sets how the device routes from one point on the route to the next. This setting is available only for some activities. Distance routes you to the next point on the route when you are within a specified distance of your current point.

Avoidance Setup: Sets the road types to avoid while navigating. This setting is available only for some activities.

Marine Map Settings

Select **Setup > Marine**.

Marine Chart Mode: Sets the type of chart the device uses. Nautical displays various map features in different colors so the marine POIs are more readable and so the map reflects the drawing scheme of paper charts. Fishing (requires marine maps) displays a detailed view of bottom contours and depth soundings and simplifies map presentation for optimal use while fishing.

Appearance: Sets the appearance of marine navigation aids on the map.

Marine Alarm Setup: Sets alarms for when you exceed a specified drift distance while anchored, when you are off course by a specified distance, and when you enter water of a specific depth.

Setting up Marine Alarms

- 1 From the main menu, select **Setup > Marine > Marine Alarm Setup**.
- 2 Select an alarm type.
- 3 Select **On**.

- 4 Enter a distance.

Device Information

Viewing Device Information

You can view the unit ID, software version, and license agreement.

Select **Setup > About**.

Support and Updates

- You can update software and maps for your handheld device using Garmin Express™.
- You can update software for your dog collar device using Garmin WebUpdater.

Support and Updates

Garmin Express (www.garmin.com/express) provides easy access to these services for Garmin devices.

- Product registration
- Product manuals
- Software updates
- Map, chart, or course updates

Setting Up Garmin Express

- 1 Connect the device to your computer using a USB cable.
- 2 Go to www.garmin.com/express.
- 3 Follow the on-screen instructions.

Updating the Software

Before you can update the handheld device or collar software, you must connect the handheld device (*Connecting the Handheld Device to a Computer*, page 12) or the collar (*Connecting the Collar to a Computer*, page 13) to the computer.

You must update the software on the handheld device and collar separately.

NOTE: Updating the software does not erase any of your data or settings.

- 1 Go to www.garmin.com/products/webupdater.
- 2 Follow the on-screen instructions.

Device Care

NOTICE

Avoid chemical cleaners, solvents, and insect repellents that can damage plastic components and finishes.

Do not store the device where prolonged exposure to extreme temperatures can occur, because it can cause permanent damage.

The device is water resistant to IEC Standard 60529 IPX7. It can withstand accidental immersion in 1 meter of water for 30 minutes. Prolonged submersion can cause damage to the device. After submersion, be certain to wipe dry and air dry the device before using or charging.

Cleaning the Device

- 1 Wipe the device using a cloth dampened with a mild detergent solution.
- 2 Wipe it dry.

After cleaning, allow the device to dry completely.

Cleaning the Screen

Before you can clean the screen, you should have a soft, clean, lint-free cloth and water, isopropyl alcohol, or eyeglass lens cleaner.

Apply the liquid to the cloth, and gently wipe the screen with the cloth.

Astro 430 Handheld Device Specifications

Water rating	IEC 60529 IPX7*
Battery type	Two 1.5 V AA batteries (alkaline, NiMH, or lithium)
Alkaline battery life	Up to 15 hr., typical usage
NiMH or lithium battery life	Up to 20 hr., typical usage
Operating temperature range	From -20° to 70°C (from -4° to 158°F)
Charging temperature range	From 0° to 50°C (from 32° to 122°F)
ANT+® wireless range	2 m (12 in.) or closer
VHF radio range (standard antenna)	30 M (33 yd.)
VHF radio range (extended antenna)	50 M (54 yd.)

*The device withstands incidental exposure to water of up to 1 m for up to 30 min. For more information, go to www.garmin.com/waterrating.

T5 Dog Collar Device Specifications

Battery type	Internal rechargeable lithium-ion battery
Battery life	From 20 to 40 hr.
Operating temperature range	From -20° to 60°C (from -4° to 140°F)
Charging temperature range	From 0° to 40°C (from 32° to 104°F)
ANT+® wireless range	Up to 10 m (32.8 ft.)
VHF radio range	Up to 14.48 km (9 mi.)
Water rating	1 ATM*

*The device withstands pressure equivalent to a depth of 10 m. For more information, go to www.garmin.com/waterrating.

T5 mini Dog Collar Device Specifications

Battery type	Rechargeable, replaceable lithium-ion
Battery life	Up to 16 to 30 hr., typical use
Operating temperature range	From -20° to 60°C (from -4° to 140°F)
Charging temperature range	From 5° to 40°C (from 41° to 104°F)
ANT wireless range	Up to 5 m (16.4 ft.)
VHF radio range	Up to 6.44 km (4 mi.)
Water rating	1 ATM*

*The device withstands pressure equivalent to a depth of 10 m. For more information, go to www.garmin.com/waterrating.

Battery Information

⚠ WARNING

This product contains a lithium-ion battery. To prevent the possibility of personal injury or product damage caused by battery exposure to extreme heat, store the device out of direct sunlight.

Do not use a sharp object to remove batteries.

The temperature rating for the device may exceed the usable range of some batteries. Alkaline batteries can rupture at high temperatures.

⚠ CAUTION

Contact your local waste disposal department to properly recycle the batteries.

NOTICE

Alkaline batteries lose a significant amount of their capacity as the temperature decreases. Use lithium batteries when operating the device in below freezing conditions.

Long-Term Storage

NOTICE

The normal long-term decrease in the charging capacity of lithium-ion batteries can be accelerated by exposure to elevated temperatures. Storing a fully charged device in a location with a temperature outside the long-term storage temperature range can significantly reduce its recharging capacity.

When you do not plan to use the handheld device for several months, the battery should be removed. Stored data is not lost when the battery is removed.

When you do not plan to use the collar for several months, the battery should be charged to about 50%. The device should be stored in a cool, dry place with temperatures around the typical household level. After storage, the collar should be fully recharged before use.

Data Management

You can store files on your device. The device has a memory card slot for additional data storage.

NOTE: The device is not compatible with Windows® 95, 98, Me, Windows NT®, and Mac® OS 10.3 and earlier.

File Types

The handheld device supports these file types.

- Files from BaseCamp. Go to www.garmin.com/trip_planning.
- JPEG photo files.
- GPX geocache files. Go to www.geocaching.com/play.
- GPI custom POI files from the Garmin POI Loader. Go to www.garmin.com/products/poiloader.

Installing a Memory Card

⚠ WARNING

Do not use a sharp object to remove user-replaceable batteries.

You can install a microSD memory card in the handheld device for additional storage or pre-loaded maps.

- 1 Turn the D-ring counter-clockwise, and pull up to remove the cover.
- 2 Remove the battery.
- 3 Slide the card holder to the left and lift up.



- 4 Place the memory card with the gold contacts facing down.
- 5 Close the card holder.
- 6 Slide the card holder to the right to lock it.
- 7 Replace the battery and cover.

Connecting the Handheld Device to a Computer

NOTICE

To prevent corrosion, thoroughly dry the USB port, the weather cap, and the surrounding area before charging or connecting to a computer.

- 1 Lift the weather cap ①.

Appendix

Accessories and Replacement Parts

Purchasing Accessories

Go to garmin.com/accessories.

Optional Maps

You can use additional maps with the device, such as BirdsEye satellite imagery, BlueChart® g2, and City Navigator® detailed maps. Detailed maps may contain additional points of interest, such as restaurants or marine services. For more information, go to <http://buy.garmin.com> or contact your Garmin dealer.

About Memory Cards

You can purchase memory cards from an electronics supplier, or purchase pre-loaded Garmin mapping software (www.garmin.com). In addition to map and data storage, the memory card can be used to store files such as maps, images, geocaches, routes, waypoints, and custom POIs.

Optional Fitness Accessories

You can use optional fitness accessories including a heart rate monitor or a cadence sensor with your device. These accessories use ANT+ wireless technology to send data to the device.

Before you can use the fitness accessory with your device, you must install the accessory according to the instructions included with the accessory.

Using Optional Fitness Accessories

- 1 Bring the device within range 3 m (10 ft.) of the ANT+ accessory.
- 2 Select **Setup > ANT Sensor**.
- 3 Select **Heart Rate Monitor, Bike Cadence Sensor, or Tempe Sensor**.
- 4 Select **On, Off, or Search For New**.
- 5 Customize the data fields to view the heart rate or cadence data ([Customizing the Data Fields, page 9](#)).

Tips for Pairing ANT+ Accessories with Your Garmin Device

- Verify that the ANT+ accessory is compatible with your Garmin device.
- Before you pair the ANT+ accessory with your Garmin device, move 10 m (32.9 ft.) away from other ANT+ accessories.
- Bring the Garmin device within range 3 m (10 ft.) of the ANT+ accessory.
- After you pair the first time, your Garmin device automatically recognizes the ANT+ accessory each time it is activated. This process occurs automatically when you turn on the Garmin device and only takes a few seconds when the accessories are activated and functioning correctly.
- When paired, your Garmin device receives data from only your accessory, and you can go near other accessories.



- 2 Plug the small end of the USB cable into the mini-USB connector ② on the device.
- 3 Plug the other end of the USB cable into an available USB port on the computer.
Your device and memory card (optional) appear as removable drives in My Computer on Windows computers and as mounted volumes on Mac computers.

Connecting the Collar to a Computer

NOTICE

To prevent corrosion, you should dry the contacts on the collar and the surrounding area before connecting the charging clip.

You can connect the collar to your computer to use with programs like BaseCamp. The collar is not a mass storage device.

- 1 Snap the charging clip onto the collar.
- 2 Plug the small end of the USB cable into the mini-USB port on the charging clip cable.
- 3 Plug the other end of the USB cable into a USB port on the computer.

Transferring Dog Tracks to BaseCamp

You can transfer the dog tracks to BaseCamp.

- 1 Connect the collar to the computer ([Connecting the Collar to a Computer, page 13](#)).
The collar turns on automatically.
- 2 Select **⏻**.
- 3 Open BaseCamp.
BaseCamp recognizes and transfers the collar's internal track log.

Deleting Files

NOTICE

If you do not know the purpose of a file, do not delete it. Your device memory contains important system files that should not be deleted.

- 1 Open the **Garmin** drive or volume.
- 2 If necessary, open a folder or volume.
- 3 Select a file.
- 4 Press the **Delete** key on your keyboard.

Disconnecting the USB Cable

If your device is connected to your computer as a removable drive or volume, you must safely disconnect your device from your computer to avoid data loss. If your device is connected to your Windows computer as a portable device, it is not necessary to safely disconnect.

- 1 Complete an action:
 - For Windows computers, select the **Safely Remove Hardware** icon in the system tray, and select your device.
 - For Mac computers, drag the volume icon to the trash.
- 2 Disconnect the cable from your computer.

Dog Device Battery Replacement Instructions

T5 Components

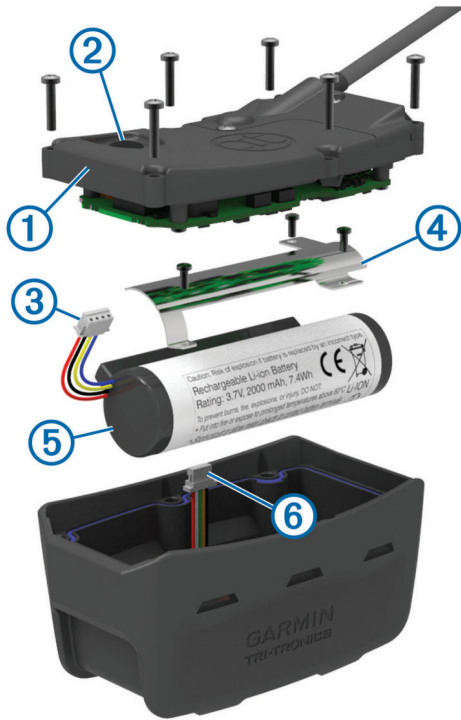

①	Back plate
②	Power key
③	Battery connector
④	Battery cover
⑤	Battery
⑥	Power connector

Removing the Old Battery

Before you replace the battery, you must remove all dirt, water, and debris from the device. You must also have a small Phillips screwdriver.

- 1 Remove the six screws from the outer edges of the back plate.
NOTE: You should leave the two inner screws in place.
- 2 Pry off the back plate.
- 3 Disconnect the battery connector and power connector.
- 4 Remove the screws that secure the battery cover.
- 5 Remove the battery cover and the battery.
Remember the orientation of the battery. You must install the new battery the same way.

After you remove the old battery, contact your local waste disposal department to properly recycle the battery.

Installing the New Battery

Before you replace the battery, you must remove the old battery ([Removing the Old Battery, page 14](#)). You also must have a small Phillips screwdriver. You may need a small flat screwdriver.

- 1 Install the new battery using the same orientation as the old battery.
The connector ① should face the end nearest the power key, and the bump ② where the wires connect to the battery should face toward the side with the charging clip contacts.

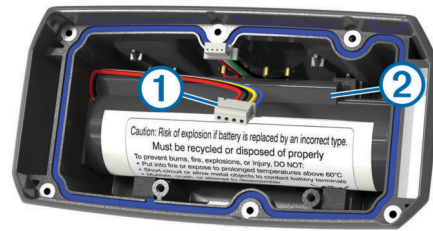

- 2 Replace the battery cover.
- 3 Replace the screws to secure the battery cover.
- 4 Connect the battery connector and power connector.
You may need to use a flat screwdriver to help secure the connectors.
- 5 Select the power key to test the connections.
When properly connected, a tone is emitted and the status LED blinks green.
- 6 Turn off the device.
- 7 Verify the gasket located inside the bottom cover is fully seated.
- 8 Replace the back plate.
- 9 Replace the six screws to secure the back plate.
After you install the new battery, charge the collar completely.

Replacing the T5 mini Dog Collar Device Battery

Before you can replace the battery, you must remove all dirt, water, and debris from the device. You also need a small Phillips screwdriver and the security screwdriver included in the battery replacement kit.

- 1 Remove the screws from the L-shaped cover over the VHF antenna.
- 2 Pry off the L-shaped cover.
- 3 Remove the screws from the outer edges of the back plate.
- 4 Pry off the back plate.
- 5 Grip the battery connector wires close to the connector, and pull the connector perpendicular to the circuit board to disconnect the battery connector from the device.
- 6 Grip the power connector wires close to the connector, and pull the connector parallel to the circuit board to disconnect the power connector from the device.
- 7 Remove the screws from the battery plate.
- 8 Remove the battery plate.
- 9 Remove the battery.
The battery fits tightly. It may be necessary to pry the battery out of the back plate using a non-sharp, non-metal object.
- 10 Install the new battery into the front enclosure with the label side of the battery facing up, and the leading edge of the battery placed under the charging contact ledge of the device.
- 11 Replace the battery plate, and replace and tighten the two screws.

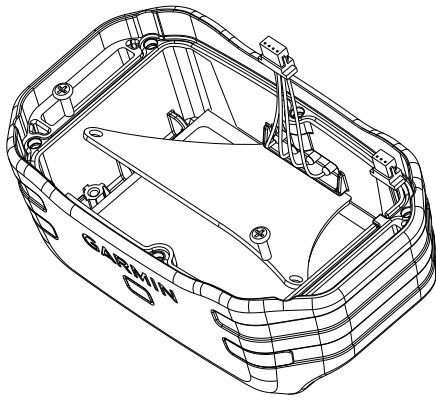

- 12 Verify the gasket is not damaged and is completely seated in the groove.
- 13 Connect the battery connector and the power connector to the device.
When properly installed, the connector plugs snap into the ports.
- 14 Replace the back plate, and replace and tighten the screws to secure the back plate.
- 15 Replace the L-shaped cover, and replace and tighten the screws to secure the L-shaped plate.
- 16 Verify the gasket is not sticking out of the device.

Replacing the Collar Strap

Before you replace the collar strap, you must remove all dirt, water, and debris from the device ([Cleaning the Device](#), page 11).

- 1 Pull the collar strap out of the GPS antenna, VHF antenna guide, and the dog device.
You may need to push and pull the collar strap to properly remove it. You may need to loosen the screw on the GPS antenna case, but do not remove them.
- 2 Thread the new collar strap through the dog device, VHF antenna guide, and GPS antenna.
- 3 If necessary, tighten the screws that secure the GPS antenna case.

VHF Radio Information

This product may be used only on specific radio frequencies, which vary depending on the country of use. The handheld device and the dog device allow the user to install a different antenna. Changing the antenna can result in improved radio performance and higher radiated power. You must not use the device with a third party antenna or an antenna not approved by Garmin. Go to www.garmin.com/tracking-legal for details about the performance and radio frequency of this product, lawful accessories, and power limits for countries.

Replacing the VHF Antenna in the Handheld Device

- 1 Locate the VHF antenna ([Astro 430 Handheld Device](#), page 1).
- 2 Rotate the VHF antenna counter-clockwise until it comes free from the device.
- 3 Insert the replacement VHF antenna into the antenna port and rotate the antenna clockwise by hand until it stops.

Replacing the VHF Antenna in the Dog Collar Device

NOTICE

Do not excessively bend the band that connects the main device case with the GPS antenna.

When the cover is removed, do not disturb the sealant opposite the VHF antenna, because this can damage the waterproof seal of the dog collar device.

Before you replace the VHF antenna, you must remove all dirt, water, and debris from the device. Also, you need a small Phillips screwdriver.

- 1 Remove the 4 screws ① from the cover over the VHF antenna.

NOTE: You should note the location of the one short screw ②.



- 2 Pry off the cover.
- 3 Remove the screw ③ securing the VHF antenna to the back plate.
- 4 Pull the length of the antenna from the antenna guide to remove the old antenna.
- 5 Loop the antenna guide around the collar strap, and thread the new VHF antenna through the guide.
This helps to point the antenna up.
- 6 Replace the screw securing the VHF antenna to the back plate.
- 7 Replace the cover over the VHF antenna.
- 8 Replace the 4 screws on the cover, replacing the short screw in the correct location.

Changing the Fuse in the Vehicle Power Cable

NOTICE

When replacing the fuse, do not lose any of the small pieces and make sure they are put back in the proper position. The vehicle power cable does not work unless it is assembled correctly.

If your device does not charge in your vehicle, you may need to replace the fuse located at the tip of the vehicle adapter.

- 1 Rotate the end piece ① counter clockwise to unlock it.



- TIP:** You may need to use a coin to remove the end piece.
- 2 Remove the end piece, the silver tip ②, and the fuse ③.
- 3 Insert a new fast-blow fuse that has the same current, such as 1 A or 2 A.
- 4 Place the silver tip in the end piece.
- 5 Push in the end piece and rotate it clockwise to lock it back into the vehicle power cable ④.

Data Fields

Accuracy of GPS: The margin of error for your exact location. For example, your GPS location is accurate to within +/- 12 ft. (3.65 m).

Ambient Pressure: The uncalibrated environmental pressure.

Ascent - Average: The average vertical distance of ascent since the last reset.

Ascent - Maximum: The maximum rate of ascent in feet per minute or meters per minute since the last reset.

Ascent - Total: The total elevation distance ascended since the last reset.

Barometer: The calibrated current pressure.

Battery Level: The remaining battery power.

Bearing: The direction from your current location to a destination. You must be navigating for this data to appear.

Cadence: The number of revolutions of the crank arm or number of strides per minute. Your device must be connected to a cadence accessory for this data to appear.

Course: The direction from your starting location to a destination. Course can be viewed as a planned or set route. You must be navigating for this data to appear.

Descent - Average: The average vertical distance of descent since the last reset.

Descent - Maximum: The maximum rate of descent in feet per minute or meters per minute since the last reset.

Descent - Total: The total elevation distance descended since the last reset.

Distance to Dest.: The remaining distance to the final destination. You must be navigating for this data to appear.

Distance to Next: The remaining distance to the next waypoint on the route. You must be navigating for this data to appear.

Elevation: The altitude of your current location above or below sea level.

Elevation - Maximum: The highest elevation reached since the last reset.

Elevation - Minimum: The lowest elevation reached since the last reset.

ETA at Destination: The estimated time of day when you will reach the final destination (adjusted to the local time of the destination). You must be navigating for this data to appear.

ETA at Next: The estimated time of day when you will reach the next waypoint on the route (adjusted to the local time of the waypoint). You must be navigating for this data to appear.

Glide Ratio: The ratio of horizontal distance traveled to the change in vertical distance.

Glide Ratio to Dest: The glide ratio required to descend from your current position to the destination elevation. You must be navigating for this data to appear.

GPS Signal Strength: The strength of the GPS satellite signal.

Heading: The direction you are moving.

Heart Rate: Your heart rate in beats per minute (bpm). Your device must be connected to a compatible heart rate monitor.

Location (lat/lon): The current position in latitude and longitude regardless of the selected position format setting.

Location (selected): The current position using the selected position format setting.

Odometer: A running tally of distance traveled for all trips. This total does not clear when resetting the trip data.

Off Course: The distance to the left or right by which you have strayed from the original path of travel. You must be navigating for this data to appear.

Pointer: An arrow points in the direction of the next waypoint or turn. You must be navigating for this data to appear.

Speed: The current rate of travel.

Speed - Maximum: The highest speed reached since the last reset.

Speed - Moving Avg.: The average speed while moving since the last reset.

Speed - Overall Avg.: The average speed while moving and stopped since the last reset.

Sunrise: The time of sunrise based on your GPS position.

Sunset: The time of sunset based on your GPS position.

Time of Day: The current time of day based on your current location and time settings (format, time zone, daylight saving time).

Time to Destination: The estimated time remaining before you reach the destination. You must be navigating for this data to appear.

Time to Next: The estimated time remaining before you reach the next waypoint in the route. You must be navigating for this data to appear.

To Course: The direction in which you must move to get back on the route. You must be navigating for this data to appear.

Trip Odometer: A running tally of the distance traveled since the last reset.

Trip Time - Moving: A running tally of the time spent moving since the last reset.

Trip Time - Stopped: A running tally of the time spent not moving since the last reset.

Trip Time - Total: A running tally of the total time spent moving and not moving since the last reset.

Turn: The angle of difference (in degrees) between the bearing to your destination and your current course. L means turn left. R means turn right. You must be navigating for this data to appear.

Update Rate: The frequency at which the collar sends data to the handheld device.

Velocity Made Good: The speed at which you are closing on a destination along a route. You must be navigating for this data to appear.

Vertical Speed: The rate of ascent or descent over time.

Vertical Speed to Dest: The rate of ascent or descent to a predetermined altitude. You must be navigating for this data to appear.

Waypoint at Dest: The last point on the route to the destination. You must be navigating for this data to appear.

Waypoint at Next: The next point on the route. You must be navigating for this data to appear.

Troubleshooting

My handheld device is not responding

If your handheld device stops responding, you can reset the device.

NOTE: This does not erase any of your data or settings.

- 1 Remove the batteries.
- 2 Reinstall the batteries ([Installing Batteries, page 1](#)).

My dog collar devices have conflicting IDs

Each dog you track has its own ID number. If two dogs within range of the handheld device have the same ID, the handheld device warns you of a conflicting ID signal. Follow the on-screen instructions to resolve the conflict.

When possible, you should allow the handheld device to automatically assign IDs. If necessary, you can manually assign a new ID number to a dog.

My handheld device does not report barks

NOTE: This feature is not available in all areas.

The bark detection feature does not work if the dog collar device is not fitted correctly. You should position the device near the

dog's vocal cords or tighten the dog collar device (*Fitting the Collar on Your Dog*, page 2).

Getting More Information

You can find more information about this product on the Garmin website.

- Go to www.garmin.com/astro.
- Go to www.garmin.com/outdoor.
- Go to www.garmin.com/learningcenter.
- See the owner's manual for your dog collar device for more information.
- Go to buy.garmin.com, or contact your Garmin dealer for information about optional accessories and replacement parts.

Registering Your Device

Help us better support you by completing our online registration today.

- Go to garmin.com/express.
- Keep the original sales receipt, or a photocopy, in a safe place.

Index

- A**
 - accessories **13, 17**
 - adding a dog **4**
 - alarms
 - clock **8**
 - marine **11**
 - proximity **8**
 - tones **10**
 - alerts
 - dog **4**
 - location **3**
 - almanac **8**
 - altimeter **10**
 - calibrating **7**
 - ANT+ sensors, pairing **13**
 - area calculation **8**
- B**
 - backlight **2, 10**
 - bark detection **9**
 - BaseCamp **4, 9, 12, 13**
 - battery **11, 12, 14**
 - installing **1**
 - life **10**
 - maximizing **4, 10**
 - replacing **14**
 - storage **12**
 - bearing pointer **7**
 - brightness **2**
- C**
 - calendar **8**
 - calibrating, altimeter **7**
 - charging, collar **1**
 - chirp **8, 11**
 - cleaning the device **11**
 - collar **4**
 - charging **1**
 - fitting **2**
 - replacing battery **14**
 - replacing strap **15**
 - VHF antenna **1, 15**
 - compass **7**
 - calibrating **7**
 - navigating **7**
 - settings **10**
 - computer, connecting **12, 13**
 - courses, pointer **7**
 - covey, marking **5**
 - custom data fields **9**
- D**
 - data
 - sharing **6, 9**
 - sharing data **9**
 - data fields **3, 7, 9**
 - deleting
 - all user data **13**
 - profiles **9**
 - device, registration **17**
 - dog **4**
 - adding **4**
 - alerts **4**
 - ID **4**
 - information **3, 6**
 - navigating to **2**
 - settings **9**
 - statistics **3**
 - status **2**
 - track and control codes **4**
 - track and train codes **4**
 - tracking **2–4**
 - tracks **3, 13**
 - type **3**
 - update rate **4**
 - downloading, geocaches **8**
- E**
 - elevation **6, 7**
 - plot **7**
- F**
 - files, transferring **8, 12**
 - finding locations **7**
 - fuse, changing **15**
- G**
 - Garmin Express **11**
 - registering the device **11**
 - updating software **11**
 - geocaches **8**
 - downloading **8**
 - settings **11**
 - geofences **3**
 - GPS **8, 9**
 - settings **9**
- H**
 - hunt metrics **3**
 - hunting and fishing times **8**
- I**
 - icons **3**
- K**
 - keyboard **2**
 - keys **1**
 - locking **1**
- L**
 - line-of-sight radio communication **4**
 - locking, keys **1**
- M**
 - main menu, customizing **9**
 - maps **5, 6**
 - data fields **7**
 - navigation **6**
 - optional **13**
 - orientation **6, 10**
 - settings **10, 11**
 - updating **11**
 - zoom **2, 10**
 - marine, alarms setup **11**
 - memory card **12, 13**
 - MicroSD card. *See* memory card
- N**
 - name, editing **3**
 - navigation **2, 6, 7**
 - altimeter **7**
- P**
 - pairing, ANT+ sensors **13**
 - power cables, changing the fuse **15**
 - power key **2**
 - product registration **11, 17**
 - profiles **9**
 - deleting **9**
 - editing **9**
 - proximity alarms **8**
- R**
 - radio communication **4**
 - radio frequencies **15**
 - registering the device **11, 17**
 - replacement parts **13–15**
 - rescue mode **9**
 - resetting the device **16**
 - routes **5**
 - creating **5**
 - deleting **6**
 - editing **5**
 - navigating **5**
 - settings **11**
- S**
 - satellite signals **8, 9**
 - acquiring **2**
 - screen. *See also* backlight
 - brightness **2**
 - cleaning **11**
 - settings **10**
 - settings **9–11**
 - sharing data **6**
 - Sight 'N Go **7**
 - software
 - updates **11**
 - updating **11**
 - specifications **12**
 - stopwatch **8**
 - sunrise and sunset times **8**
- T**
 - time settings **10**
 - tones **10**
 - TracBack **6**
 - tracks **3, 6**
 - navigating **6**
 - recording **6**
 - saving **6**
 - settings **9, 10**
 - transferring
 - files **8, 12**
 - tracks **13**
 - trip information
 - resetting **7**
 - viewing **7**
 - trip planner. *See* routes
 - troubleshooting **16, 17**
 - bark detection **16**
 - dog signals **16**
- U**
 - unit ID **11**
 - units of measure **10**
 - updates, software **11**
 - USB
 - connector **1**
 - disconnecting **13**
 - mass storage mode **12**
 - transferring files **12**
 - user data, deleting **13**
- V**
 - VHF antenna **15**
 - VIRB remote **9**
- W**
 - WAAS **9**
 - waypoints **4, 7**
 - deleting **5**
 - editing **5**
 - navigating **5**
 - projecting **5**
 - saving **4, 5**
- Z**
 - zooming, maps **2**

www.garmin.com/support



1800 235 822



+43 (0) 820 220230



+ 32 2 672 52 54



0800 770 4960



1-866-429-9296



+385 1 5508 272
+385 1 5508 271



+420 221 985466
+420 221 985465



+ 45 4810 5050



+ 358 9 6937 9758



+ 331 55 69 33 99



+ 39 02 36 699699



(+52) 001-855-792-7671



0800 427 652



0800 0233937



+47 815 69 555



00800 4412 454
+44 2380 662 915



+35 1214 447 460



+386 4 27 92 500



0861 GARMIN (427 646)
+27 (0)11 251 9800



+34 93 275 44 97



+ 46 7744 52020



+886 2 2642-9199 ext 2



0808 238 0000
+44 870 850 1242



+49 (0) 89 858364880
zum Ortstarif - Mobilfunk
kann abweichen



913-397-8200
1-800-800-1020

