



Compatibility Guide for Wheelchair Attachments

V.1.1.3

As part of our installation process, you will attach our mounting clamps onto your wheelchair.

Our wheelchair attachments fit most wheelchairs. However, a few wheelchairs will not fit our clamps. Use this guide to determine if our devices are right for you.

There are *five* points that must be considered in order to determine whether your wheelchair is compatible with our wheelchair attachments:

1. Seat width. Must be between 14 to 22 in -or- 35.5 to 55.8 cm (*measured **end-to-end** on the width of your seat cushion*).
2. Tube diameters. Currently supported tubing diameters are:
 - 7/8 in -or- 22.2 mm
 - 1 in -or- 25.4 mm
 - 1.125 in -or- 28.6 mm
 - 1.2 in -or- 30.5 mm
 - 1.25 in -or- 31.8 mm
3. Tube clearance. To attach the clamps, 1.25 in -or- 32 mm clearance is required. Diagrams with examples of tube clearances are given in the following two pages.
4. Tube angle. Ideally the tubes should be vertical or close to vertical. However, installation is possible with tubes that taper inwards with slight angles, the larger the taper angle the more challenging it is to use our "Quick Release Coupler" attachment. See the diagrams on the following page where illustrations of wheelchair designs with tapering tube angles are shown.
5. Footrests on folding chairs. Removable footrests can pose challenges for our clamp installation, so please consult Page 3 where examples of wheelchair designs with removable footrests are given. Never mount our clamps directly onto removable footrests as they were not designed to take such riding forces.



Compatibility Guide for Rigid Wheelchairs

All of our devices require about 1.25 in -or- 32 mm of clearance on the upper frame tubing.

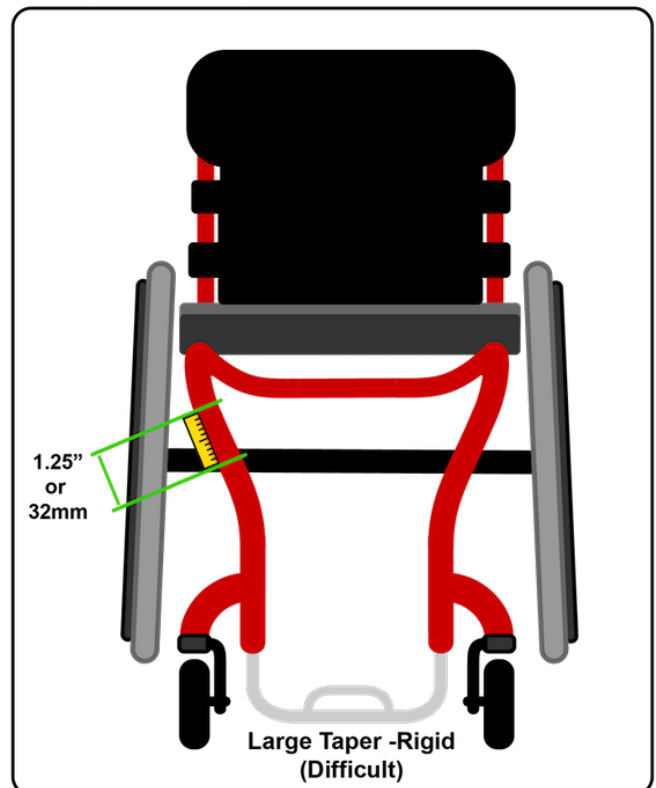
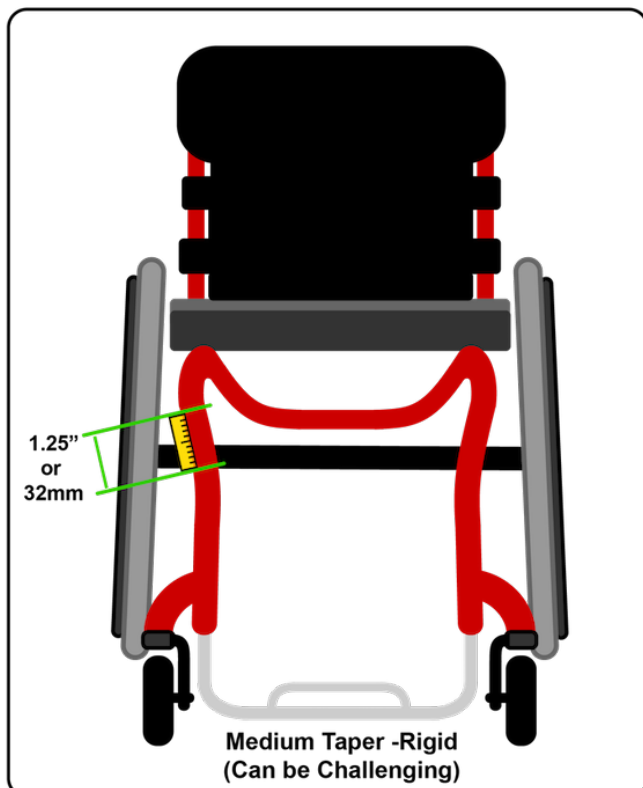
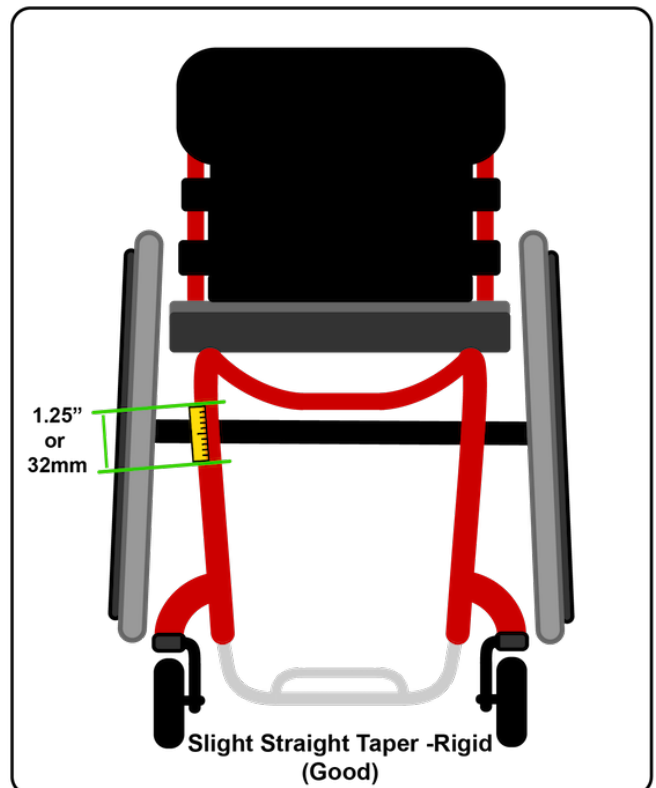
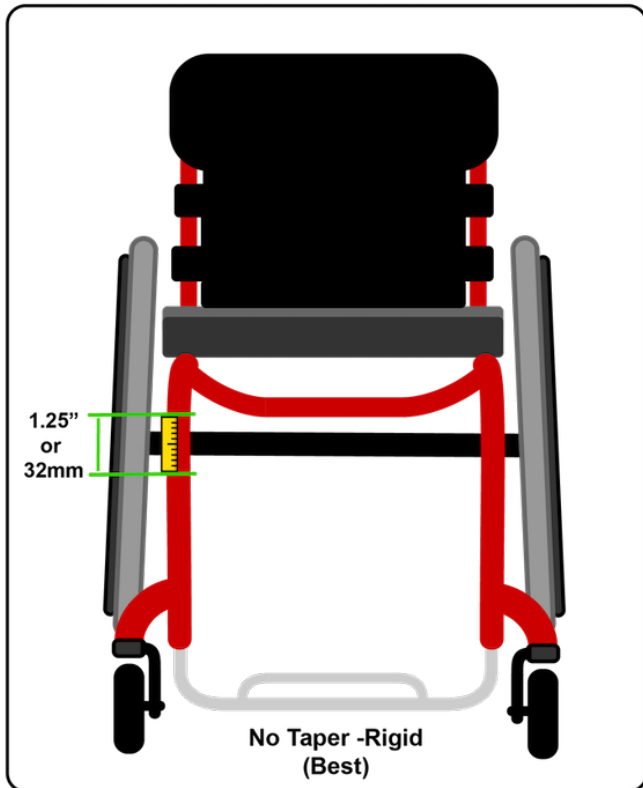

Compatibility Guide for Folding Wheelchairs

All of our devices require about 1.25 in -or- 32 mm of clearance on the upper frame tubing. Ideally this clearance should be above the area where the removable footrests attach too.

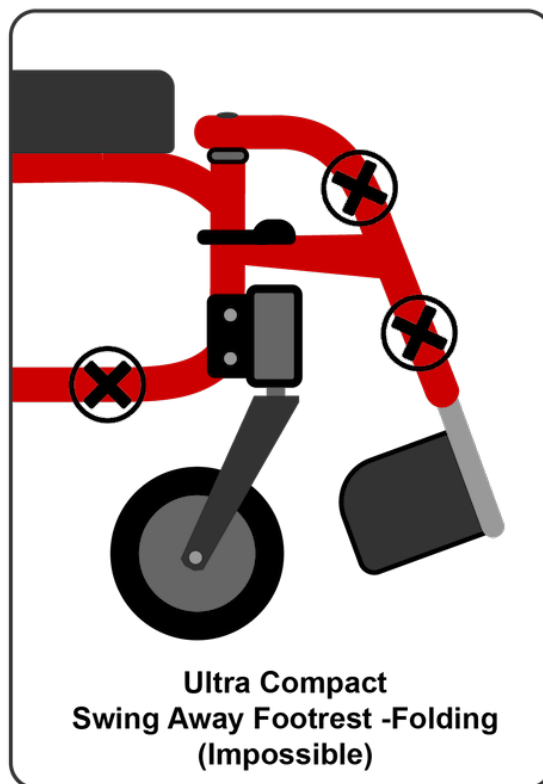
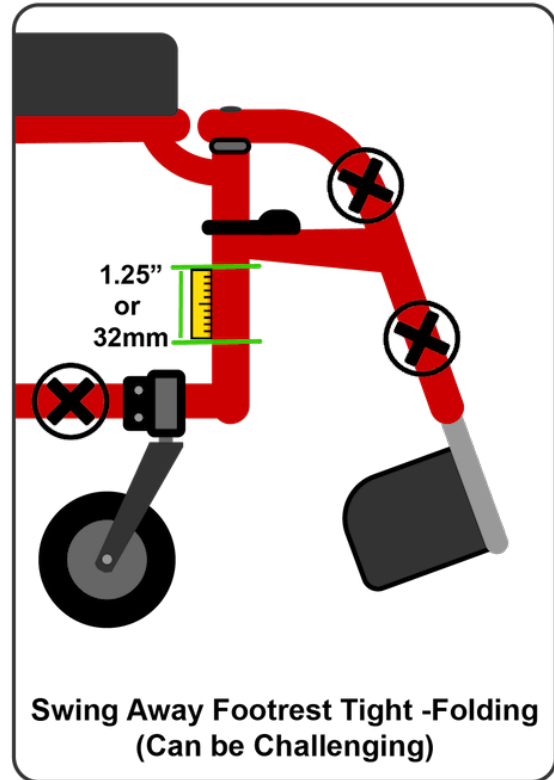
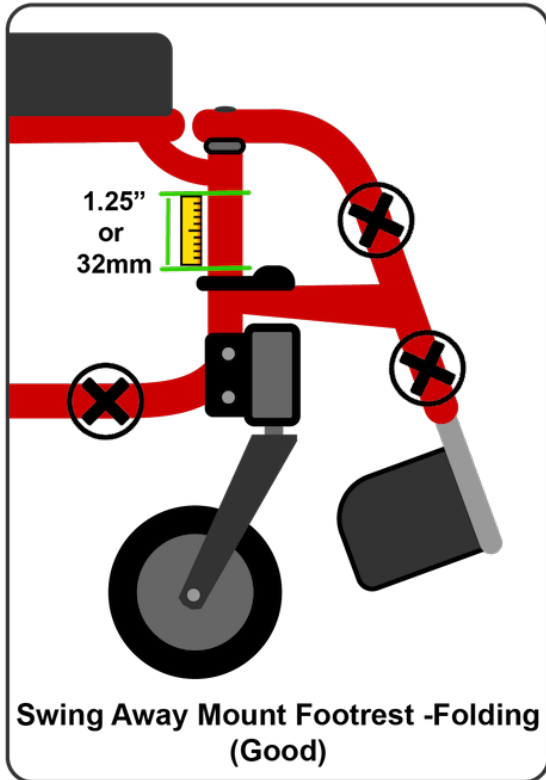

RIO MOBILITY

The optimal installation angle for your wheelchair attachment



Good:

- 1) The chair clamps mounted high on straight tubing
- 2) Tire is as close to the foot rest while still allowing ample foot clearance from the tire while steering
- 3) The handlebar is high enough to clear the knees and allow body torso clearance when steering

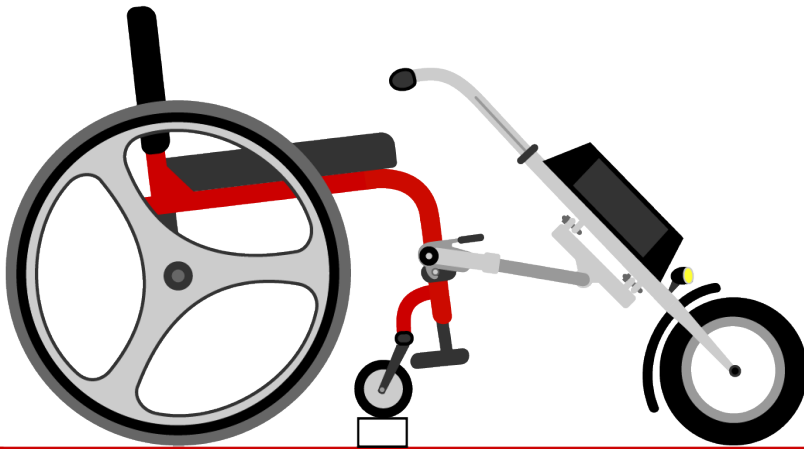

Pros:

In some cases this angle is the only way to mount onto smaller width chairs meant for smaller riders or some folding chairs

Cons:

Can lose traction on the front wheel while climbing hills

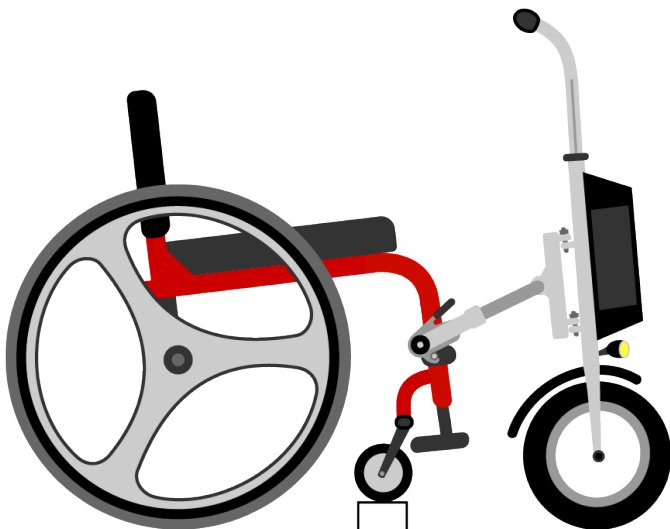

Pros:

More traction on the ground

Cons:

Handlebar is farther from the user. Steering is not optimal