



verotti

— Bathroom Culture —

Intelligent Toilet User Manual
Apply to IN.200, IN.300
ET.200, ET.300

IN.200



ET.200/ET.200SS

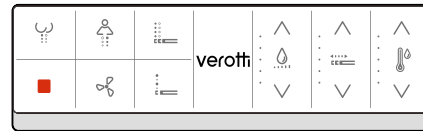

IN.300



ET.300/ET.300SS



Add. Building M, 61-65 Roberts Road
Greenacre NSW 2190 Australia Tel:
1300 837 688
Fax: 1300 837 888
Email: info@verotti.com
Website: www.verotti.com



Thank you for choosing Verotti

- Please read the instructions and related illustration carefully before installation and use.
- All products demonstrated in the illustrations are for reference purposes only and actual product may differ from illustrations.
- The company reserves the right to alter, modify or change any product without prior notice.

Please contact with us if you have any questions on the manual.

Product Features

Contents

		IN.300 ET.300	IN.200 ET.200
			
Washing	Rear wash	●	●
	Lady wash	●	●
	Oscillation massage	●	●
	Pulsing massage	●	●
	Water pressure adjustment	●	●
	Water temperature adjustment	●	●
	Nozzle position adjustment	●	●
Cleaning	Nozzle self-cleaning	●	●
	Detachable nozzle	●	●
	Anti-bacterial nozzle	●	●
	Seat and cover quick release	●	●
Comfort	Heated seated	●	●
	LED night light	●	●
	Instant water heating	●	●
	Warm air drying	●	●
	Pre-wetting	●	●
	Deodorization	●	●
	Descaling	●	●
Control	Rotary knob control	●	●
	Remote control	●	●
Cert.	EN1717	●	●
	IPX4	●	●
	CE	●	●
	RoHS	●	●

Chapter 1 Safety Precautions02

1.1 Description of symbols	03
1.2 Normal use	03
1.3 User requirements	03
1.4 Only use the product in operating condition	03
1.5 Toilet seat unit use	03
1.6 Battery safety instructions	04
1.7 Other safety precautions	05

Chapter 2 Product Overview11

2.1 Toilet seat unit	11
2.2 Remote control front button illustration	12
2.3 Remote control back button illustration	13
2.4 Setting panel illustration	13
2.5 Function display list on the back of the remote control	14

Chapter 3 Operating Instruction15

3.1 Initialization operation instruction	15
3.2 Toilet button operation instruction	17
3.3 Rotary knob operation instruction	18
3.4 Remote control front button operation instruction	19
3.5 Remote control back temp adjustment operation instruction	25
3.6 Descaling reminder setting (back of remote control)	25

Chapter 4 Cleaning and Maintenance27

4.1 Toilet seat unit cleaning	27
4.2 Nozzle cleaning	27
4.3 Remote control cleaning	28
4.4 Deodorizing device cleaning	28
4.5 Descaling	31
4.6 Waste disposal	32
4.7 Product maintenance	32
4.8 Winter product maintenance	33

Chapter 5 Troubleshooting34

Chapter 6 Technical Date38

Chapter 1 Safety Precautions

In order to prevent danger or property loss to users or others, please read [Safety Precautions] carefully and be sure to comply with it!

1.1 Description of symbol



Warning

If this icon is ignored, it may cause serious injury or death.



Caution

If this icon is ignored, it may cause personal injury or property loss.

Icon explanation as follows :



Mandatory content that must be executed



Prohibited



Disassembly or unauthorized modification is prohibited



Connect ground



Prohibit water soaking



Do not touch with wet hands.



Prohibit high temperature and flammable objects.

To ensure that you can enjoy the intelligent toilet, please read the instructions carefully, especially the safety instructions. Please keep this instruction manual properly for future reference. If the product needs to be replaced, please be sure to attach this instruction manual. All instructions have been transferred to others, confirmed in accordance with the latest technical status of the equipment at the time of printing. IMEX reserves the right to make changes as a result of further development.

1.2 Normal use

This machine is an intelligent toilet seat with rear wash and lady wash functions, can be used as a regular toilet. It can only be used for indoor enclosed spaces. Any other use will be deemed to be inconsistent with normal use. For abnormal use, we do not assume any responsibility.

1.3 User requirements

Children and people who do not understand the equipment and people suffer with physical, sensory, mental and other health issues, can use the product after safety instruction or under the supervision of others.

Make sure children do not play with this product.

1.4 Only use the product in operation condition



Warning

Make sure the power cord is not damaged.

The power cord cannot be jammed or squeezed.

Keep the power cord away from hot surfaces and sharp edges.

Do not use the toilet seat when it is not working properly. Disconnect the power supply, close the stop valve, stop the water supply, contact the customer service hotline to avoid product failure and damage caused by improper use.

1.5 Toilet seat unit use

The cold water of the toilet seat unit shall be connected from the main water supply pipe.

Use the new hose assembly that comes with the appliance. The old hose assembly cannot be reused.

The product itself does not have the function of leakage protection, should be installed in the line of leakage protector.

The fixed wiring must be provided with a device for full-stage disconnection under the condition of overvoltage class III according to the wiring rules and the contact distance.

The specification of the fixed wiring power line is the nominal cross-sectional area of the conductor 1-2.0mm² (17-14AWG)

Confirm that the grounding end of the power supply wire is 10mm (3/8") longer than the live wire (L) and zero wire (N).

Please make sure that the electrical junction box has been fixed on the wall before install the product.

Condensation moisture may occur if the temperature of the product is moved from a colder to a hotter location. Please turn off the device for a few hours.

Do not contaminate, spray or clog the cleaning sprayer on purpose.

Please do not flush newspaper, diapers, sanitary napkins and other articles into the toilet, they are easy to block the product. Maintenance work must be carried out by the relevant professional staff.

Please do not use the unrecommendation accessories .

1.6 Battery safety instructions



Do not touch skin, eyes or mucous membranes if battery acid leaks.

If you touch the acid, flush the affected area with plenty of water and seek medical attention immediately.

Keep the battery out of reach of children .If swallowed, batteries can be life-threatening .If the battery has been swallowed, seek medical advice immediately.

Do not charge the battery, do not use other tools to reactivate the battery, do not put it in fire or make it short circuit.

When the battery runs out, remove it from the control immediately. Otherwise the liquid may leak and cause damage.

Do not mix the old and new batteries into the remote control.

Clean the battery and contacts before installation. Pay attention to the correct polarity of the battery when installing.

If the control is not used for a long time, please remove the battery.

Do not put the battery in extreme conditions: avoid contacting with heat or exposure to the sun. Otherwise, leakage may occur.
Do not short the positive and negative terminals of the remote control.

1.7 Other safety precautions



People with disabilities and lack of experience or common sense (including children) should use the product under the supervision of a responsible person.

This product must connect the cold water supply (water temperature between 1 ~ 30 ° C), otherwise it may scald or machine fault.

In case of abnormality or failure, please immediately disconnect the power supply, close the inlet angle valve and stop using.

The abnormal and fault conditions are as follows□

--The product is cracked or damaged

-- Smoke emitting

-- Abnormal sound and burning smell

-- Abnormal product heating

-- Water seepage from inside pipes and product

Continued use regardless of product failure may result in electric shock, fire, injury, or indoor seepage.



Do not put your fingers or other objects into or block the drying outlet. Otherwise, it may cause scald, electric shock or seat damage.

This product belongs to electrical products, so please do not install it in places where it is easy to be soaked by water or high humidity.

Do not spill water or detergent on the product, the bottom of the product and the power plug, or it will cause electric shock, short circuit and fire.



Do not hold the cover or seat to pick up the product.
Do not open the cover or seat when there is something placing on the cover or seat. Otherwise may cause product damage or personal injury.



When using in the bathroom, make sure the power outlet is waterproof. It may cause electric shock or fire, if not.



Prohibit water soaking

Do not spray water or detergent on the toilet seat unit and power plug. It may cause product damage, fire, or electric shock.



Connect the ground wire

Check the power socket whether grounded or not. This product must be well grounded. Can only be connected to the dedicated 220V-240V, 50/60Hz, 10A with ground fault circuit breaker or ground leakage protector circuit.

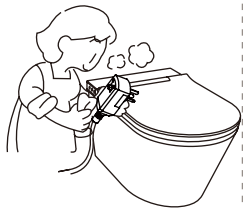

Mandatory

After removing the dust from the plug, be sure to firmly insert the power plug into the socket. Unplug and clean with a dry cloth.

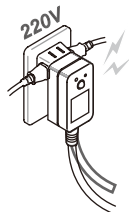

Prohibit overload on socket

Suitable for professional distribution with ac voltage 220V-240V (50/60Hz) only. Otherwise, it may lead to overheating or fire.

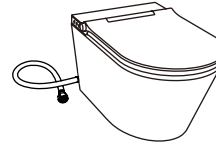

Prohibited

Do not bend or twist the water supply hose. It may cause water leakage.



Prohibited

Do not use the following items to clean the product: gasoline, banana water, benzene, paint thinner, decontamination powder and nylon brush. It may damage the inlet pipe or product.

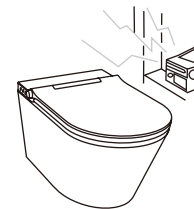

Prohibited

Keep away from the product when using the radio.

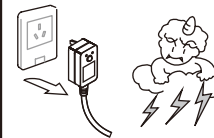

Mandatory

Unplug when thundering. May cause electric shock.

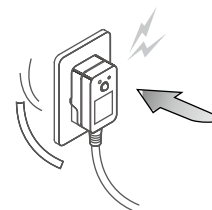

Prohibited

Do not use loose or faulty outlets. It may cause electric shock or fire.

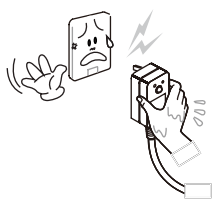

Prohibit wet hands

Do not plug or unplug the power plug with wet hands. It may cause an electric shock.

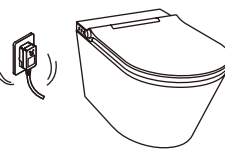

Prohibited

Do not pull or damage the power plug / power cord. It may cause fire, short circuit, or electric shock.

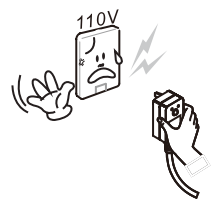

Prohibited

Do not use a DC or AC power supply that is not 220V-240V. May cause product failure.

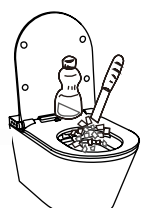

Pull out the plug

Please cut off the power and pull out the plug before removing or cleaning the product. It may cause electric shock or fire.

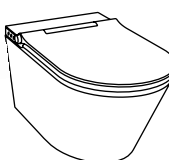

Mandatory

If the power cord is damaged, it needs to be replaced. To avoid danger, please observe the following: Please contact the retail store where you purchased this product or the nearby customer service center. It must be replaced only by the manufacturer, its service department or an authorized professional.



Pull out the plug

When not in use for a long time, drain the water from the water hose and unplug the power cord. It may cause water pollution and skin infections.



Prohibited

Do not lean on the cover. It may damage the seat cover and cause personal injury.

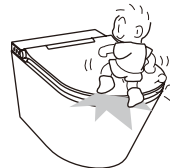

Prohibited

Do not allow children to play on the seat or on the cover, do not step on, sit or place heavy objects on the cover. It may cause personal injury or damage to the product. Children should be supervised to ensure that they do not play with the appliance.



Prohibited

Do not install the product in a room where frost may develop. Indoor temperature shall not be less than 4 °C. In order to prevent product freezing or damage.

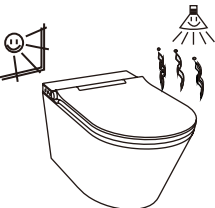

Prohibited

Do not expose the product directly to water, strong light or sunlight. It may cause fading.



Prohibited
Please do not force the cover and seat to close.
It may damage the product.



Prohibited
Do not pour urine on the body and nozzle.
Otherwise, it will lead to malfunction or stains.



Prohibit high temperature
Do not place high temperature and flammable materials near the product.
It may cause fire.



No dismantling
No matter for any purpose, do not separate, repair or alter this product on your own.
It may cause fire, short circuit and electric shock.

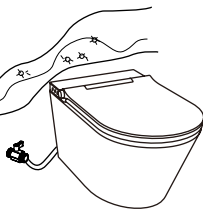

Prohibited
Do not connect any wastewater, mixed water, industrial water, seawater or other untreated or semi-treated water.
It may cause skin infection or malfunction.

Chapter 2 Product Overview

2.1 Toilet seat cover

Heating seat model

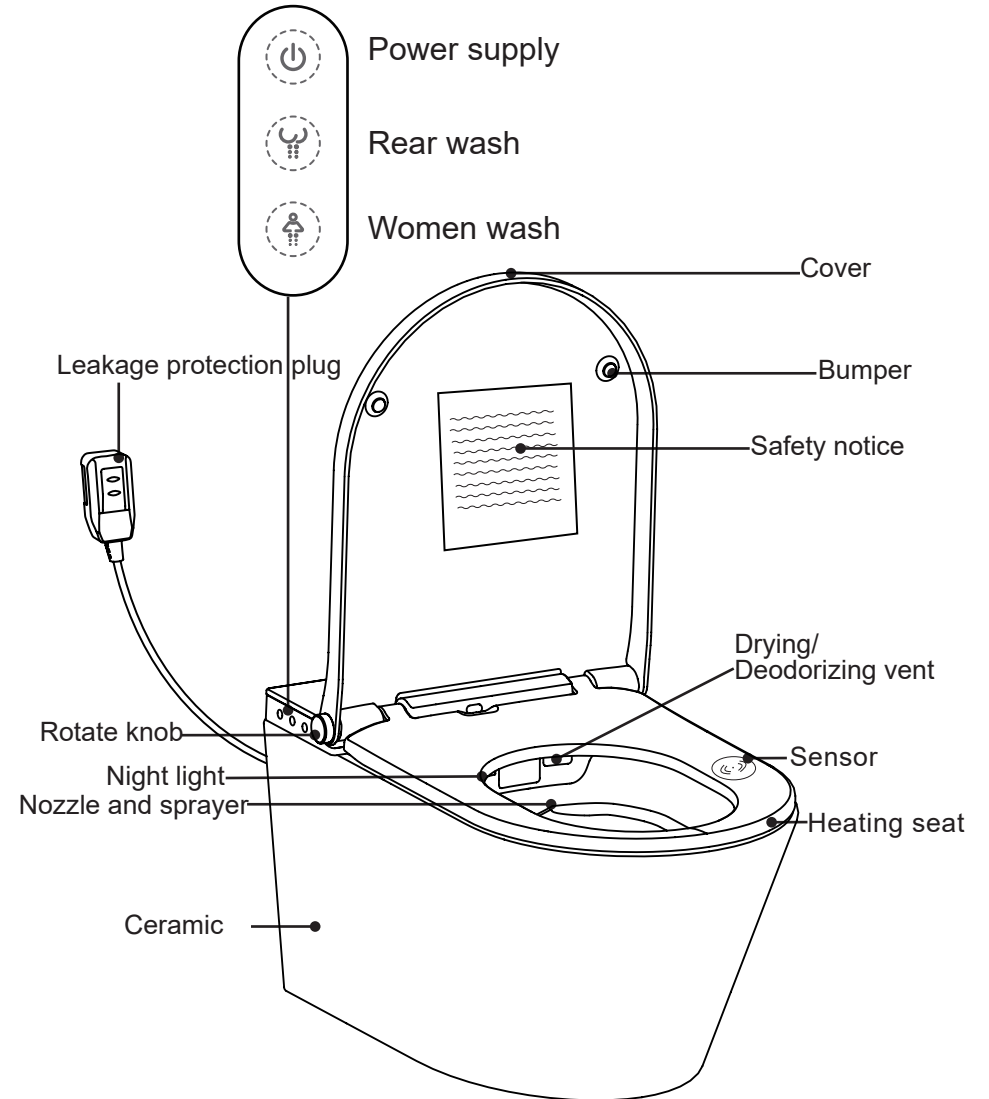

2.2 Remote control front button illustration

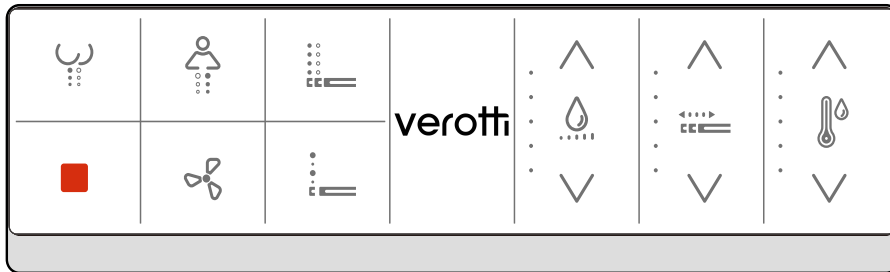

Icon	Button	Icon	Button
	[Rear wash]		[Water pressure adjustment]
	[Lady wash]		
	[Stop]		[Nozzle position adjustment]
	[Warm air drying]		
	[Oscillation massage]		[Water temperature adjustment]
	[Pulsing massage]		

(See pages 19-24 for details of each button function)

2.3 Remote control back button illustration

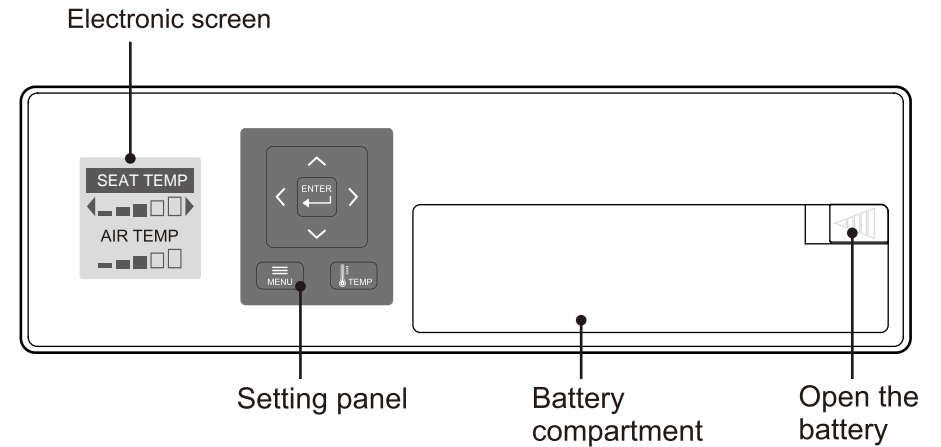

2.4 Setting panel illustration



[ENTER]



[SET/RETURN]
·Return to the previous menu



[TEMP ADJUSTMENT]
·Adjust the temperature
(see pages 24 for detail)



[SELECT FUNCTION]



[SELECTION SETTING]
(See pages 25-28 for details)

1. Press Automatically switch electronic screen display

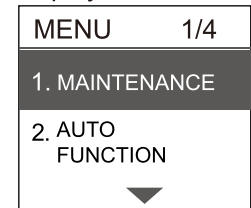

2. Looking at the electronic screen for setting



(Up and down) Press to select function

When not selected When selected



After pressing " ", the setting will be applied

2.5 Function setting list on the back of the remote control

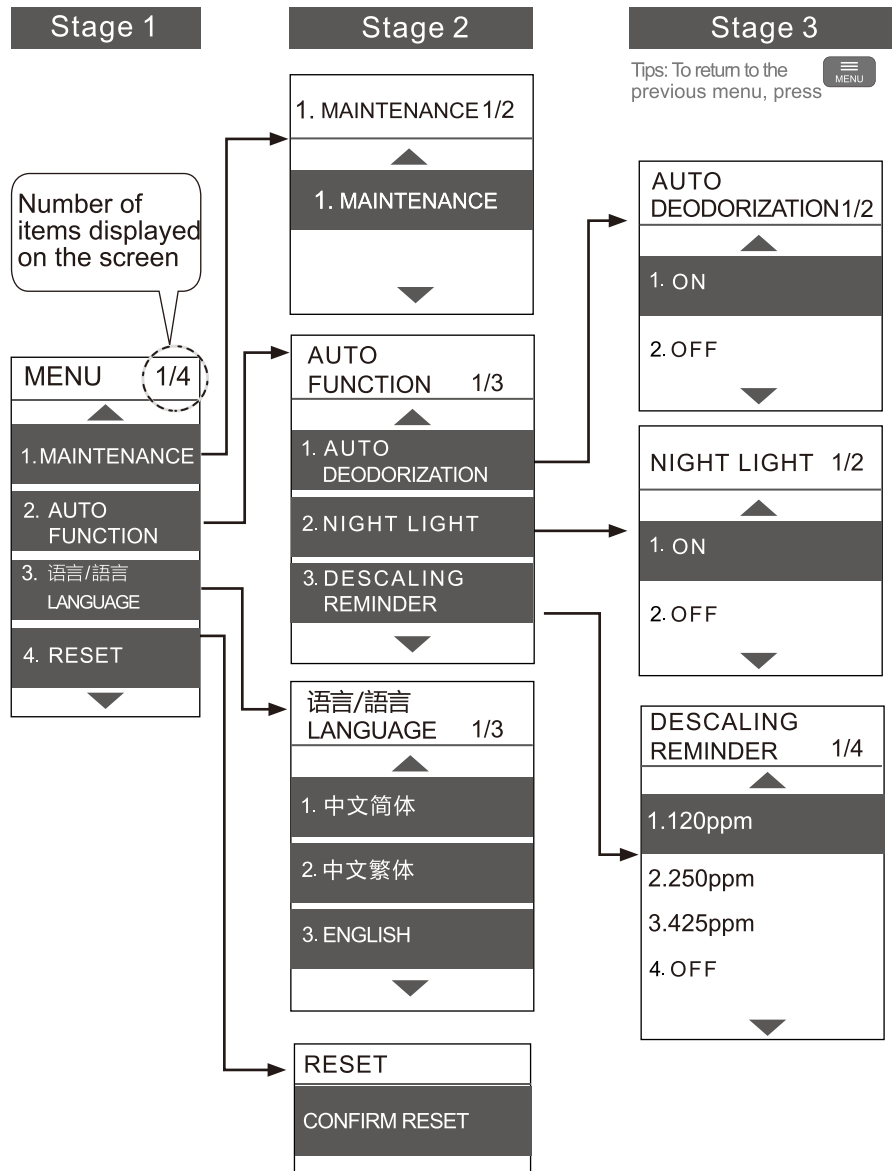

Chapter 3 Operating Instruction

3.1 Initialization operation

1. Open the intake angle valve and make sure the instruction water is connected.

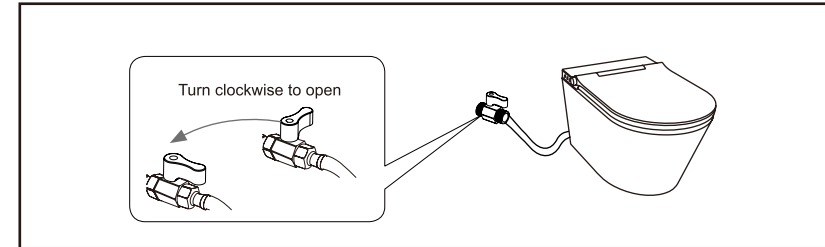

2. Install the battery for remote control

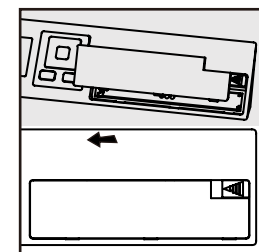

a. In the position shown on the back of the remote control, push hard to the left, and open the battery cover as shown above.

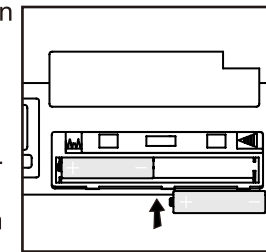

b. Install two AAA batteries.

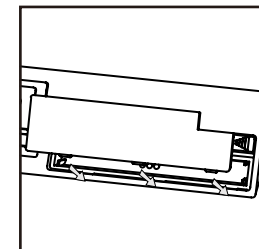

c. As shown, use the battery cover to align the notch with a small bump and cover the battery cover.

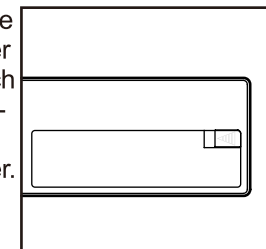

d. Complete the installation.

Try to operate the remote control. If the state light of the remote control lights up with the button, the battery will be installed successfully. If the remote control is not available, please check whether the battery is charged and correctly installed. If the battery runs out of power, you can change the new battery follow above.

3.Match code

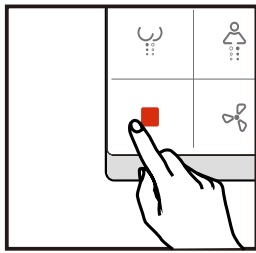

a.Press the "Stop" button until the remote control status light flashes. (make sure the toilet power switched

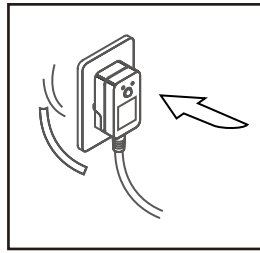

b.Turn on the power of the machine, the leakage protection plug light is on, it will start "Initialization"

off before matching)

for 15 seconds, After one beep sound and the light off, the code was matched.

If the code matching is unsuccessful, the indicator will automatically off after 30 seconds. Try again as described above. If it is still unsuccessful, please consult professional staff.

4.Install the battery for rotary knob

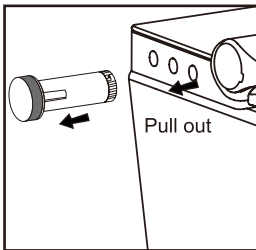

a.Pull the rotary knob out horizontally as shown

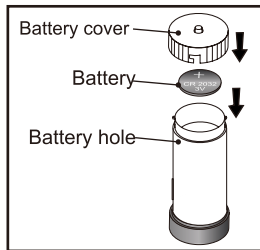

b.Open the battery cover and insert the battery into the battery hole. (Note that the battery positive pole printed

with + CR 2032 3V facing up, as shown)

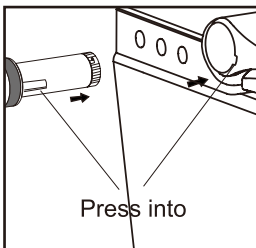

c.Place the rotary knob aligned with the positioning slot, as shown.

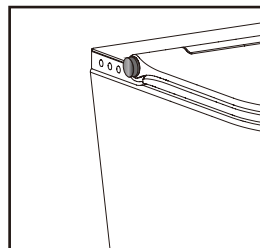

d.Complete the installation

5.Rotary knob match code

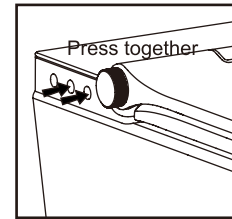

a.Press the "Power"and "Rear wash" button at the same time.

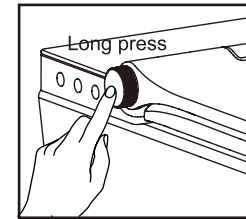

a.Press and hold the "Rotary knob" until you hear a long beep, which means that the code

When you release it, you hear a long beep from the machine, and the machine is ready for code matching (if there is no beep, it may be due to different pressing, you can try again).

is successfully matched. If it is unsuccessful, try again according to the above steps; if it is still unsuccessful, please consult the after-sales service.

3.2 Toilet button operation instruction

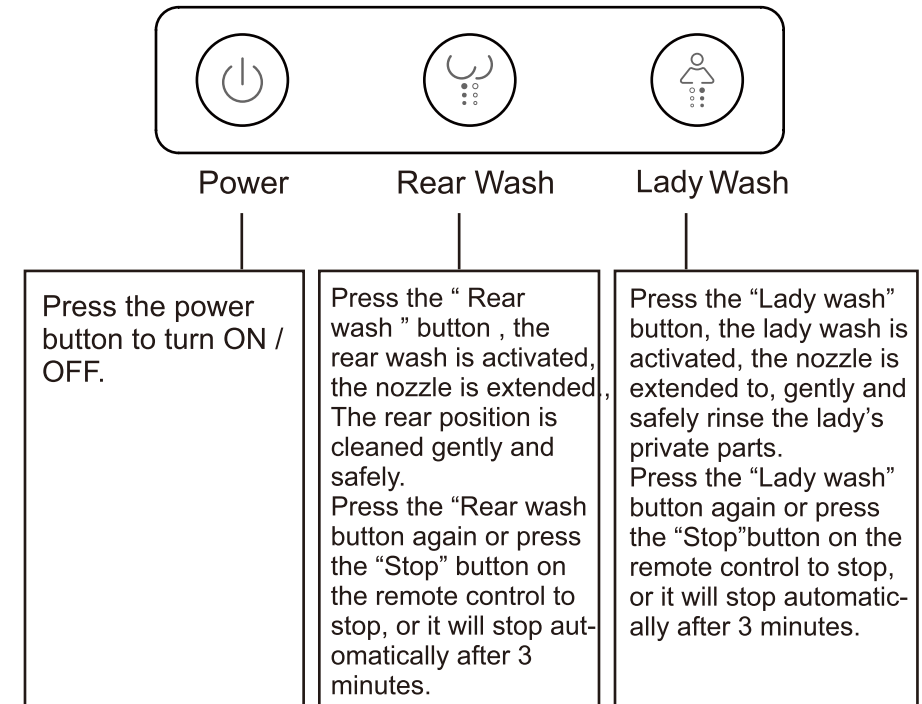

3.3 Rotary knob operation instructions

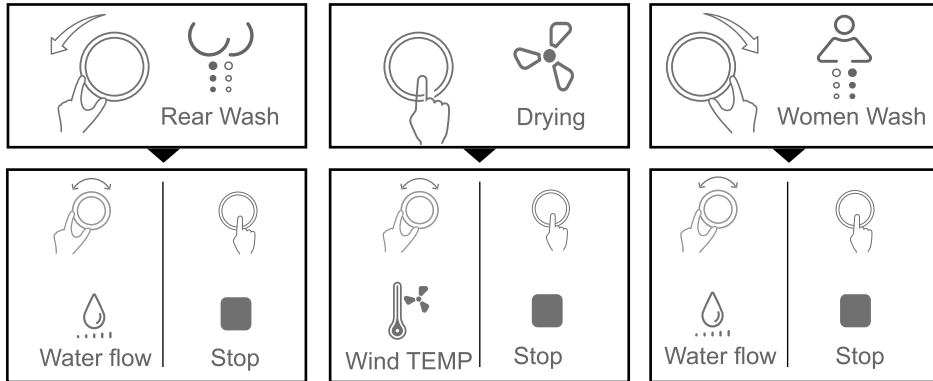

1. Under the condition of seat induction, after rotate backward the rotary knob, beeping shortly, nozzle stretched, and the [Rear wash] function is activated

2. Under the washing condition, rotate forward and backward the rotary knob to adjust the water pressure. Rotate forward, the water pressure rises and vice versa. A beep sound means a grade, with total of 5 grades; two beeps sound means highest grade or lowest grade.

3. Fixed washing cycle is 3 minutes, and stopped automatically, or press and hold rotary knob to stop.

1. Under the condition of seat induction, after rotate backward the rotary knob, beeping shortly, nozzle stretched, and the [Warm air drying] function is activated.

2. Under the drying condition, rotate forward and backward the rotary knob to adjust the air speed. Rotate forward, the water pressure rises and vice versa. A beep sound means a grade, with total of 5 grades; two beeps sound means highest grade or lowest grade.

3. Fixed drying cycle is 4 minutes, and stopped automatically, or press and hold rotary knob to stop.

1. Under the condition of seat induction, after rotate backward the rotary knob, beeping shortly, nozzle stretched, and the [Lady wash] function is activated.

2. Under the washing condition, rotate forward and backward the rotary knob to adjust the water pressure. Rotate forward, the water pressure rises and vice versa. A beep sound means a grade, with total of 5 grades; two beeps sound means highest grade or lowest grade.

3. Fixed washing cycle is 3 minutes, and stopped automatically, or press and hold rotary knob to stop.

3.4 Remote control front button operation instruction

This intelligent toilet is operated by rotary knob and remote control. Rotary knob could control lady wash, rear wash, drying function and stop. Other functions are controlled by the remote control, including settings that are also changed by the remote control. Press the corresponding button on the remote control to activate the corresponding function. The button will briefly light up in the white backlight and disappear after 10 seconds.

If the remote control is not available, please check whether the battery is installed or whether the battery is charged. If not, please refer to the initialization operation to install the battery.

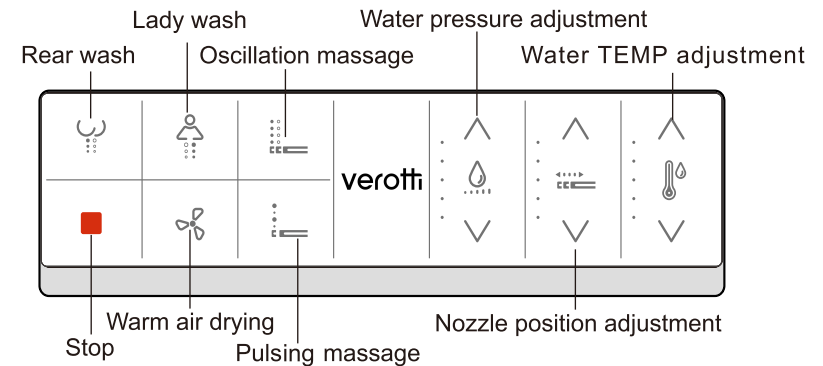

■ **Stop** Press the "Stop" button to stop the function in progress.

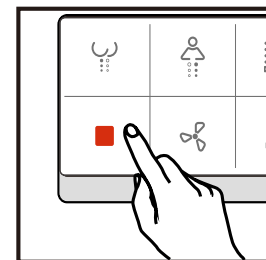

In any case, "Stop" is the button with the highest priority, can stop the current function after pressing.

When more than 2 button presses are detected the first button press is valid.



Rear Wash

Press the "Rear wash" button, the indicator light turns on, the system buzzer beeps, and the rear wash function starts.

Conditions: under the seat induction conditions.

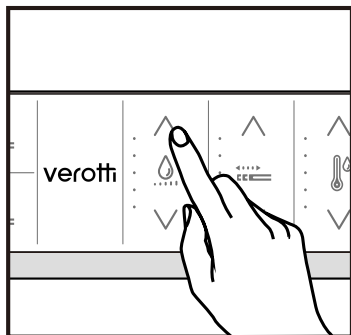

During rear washing, press " ^ " of "Water pressure adjustment" to increase the water spray intensity; press " v " to decrease the water spray intensity.

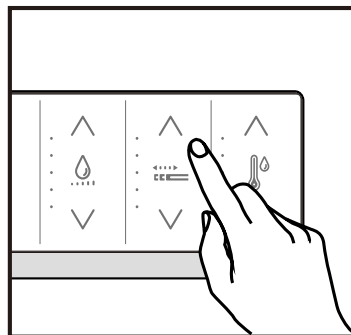

During rear washing, press " ^ " of "Nozzle position adjustment" to move the nozzle forward; press " v " to move the nozzle backward.

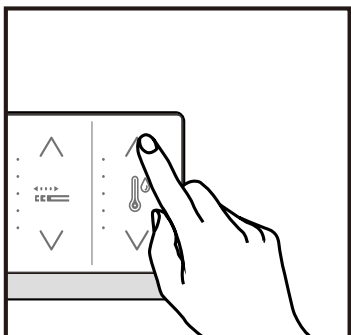

During rear washing, press " ^ " of " Water temperature adjustment " to increase the water temperature; press " v " to decrease the water temperature.

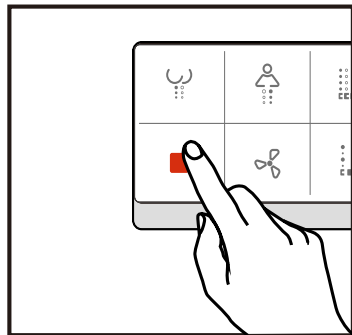

Press the " Stop " button to stop or wait for 3 minutes to stop automatically.



Lady Wash

Press the "Lady wash" button, the indicator light turns on, the system buzzer beeps, and the women's washing function will start.

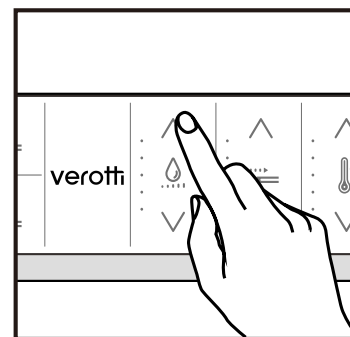

Under lady washing, press " ^ " of " Water pressure adjustment " to increase the water spray intensity; press " v " to decrease the water spray intensity.

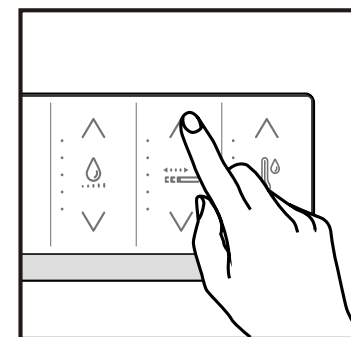

During lady washing, press " ^ " of " Nozzle position adjustment " to move the nozzle forward; press " v " to decrease the water spray intensity.

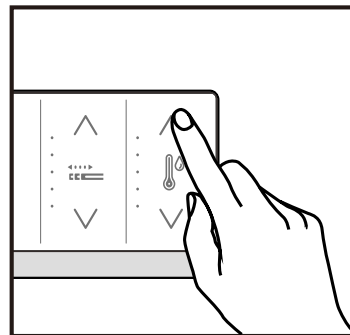

During lady washing, press " ^ " of " Water temperature adjustment " to increase the water temperature; press " v " to decrease the water temperature.

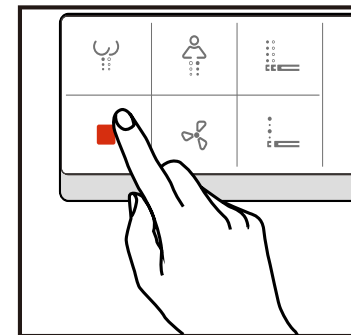

Press the "Stop" button to stop or wait for 3 minutes to stop automatically.



Warm air drying

Press the "Warm air drying" button to blow out comfortable warm air.

Conditions: under the seat induction conditions.

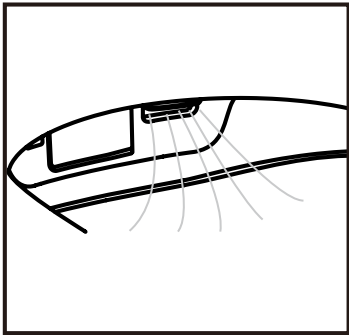

"Warm air drying" is activated, the warm air cover opens, and comfortable warm air blows out.

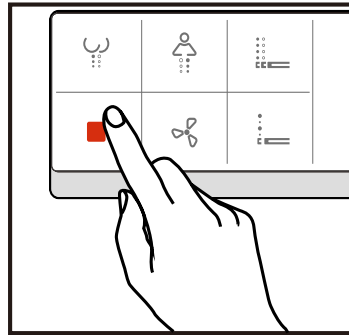

Press the "Stop" button to stop or wait for 3 minutes to stop automatically.



Oscillation massage

Press "Mobile massage" button, the nozzle moves back and forth when using the cleaning function.

Condition: Rear wash or lady wash function have been activated.

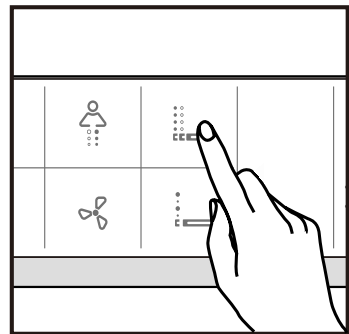

"Oscillation massage" is activated and the nozzle moves back and forth.

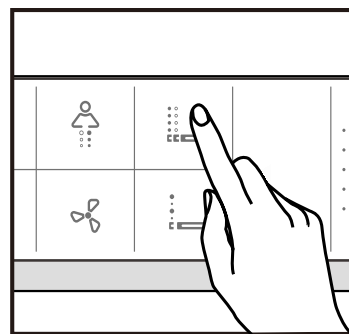

Press "Oscillation massage" again to stop and switch back to Rear wash /Lady wash, or wait for 3 minutes to stop automatically.



Pulse massage

Press "Pulsing massage" button, the water spray intensity changes when using the cleaning function.

Condition: Rear wash or lady wash function has been activated.

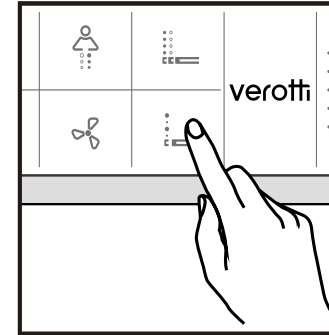

"Pulse massage" is activated and the intensity of the water spray changes.

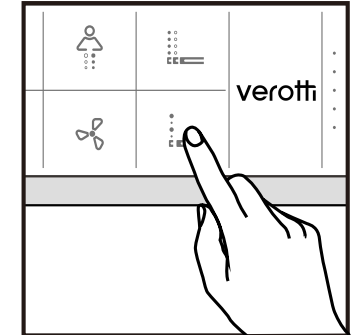

Press "Pulsing Massage" again to stop and switch back to Rear wash / Lady wash, or wait for 3 minutes to stop automatically.



Nozzle position adjustment

There are 5 grades of "Nozzle position adjustment". The default setting is grade 3.

Condition: Rear wash or Lady wash function has been activated.

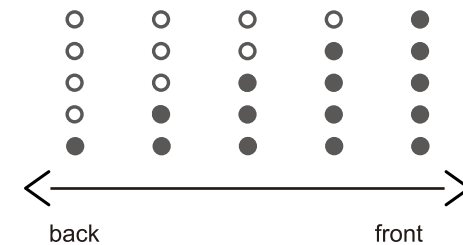

Press " ^ " of the "Nozzle position adjustment", the nozzle extends forward, and each time you press it, it increases by 1 grade up at the highest grade. When you press " v ", the nozzle retracts backward, and each time you press it, it decreases by 1 grade up to the lowest grade.



Water pressure adjustment

There are 5 grades of "Water pressure adjustment". The default setting is grade 3.

Condition: Rear wash or Lady wash function has been activated.

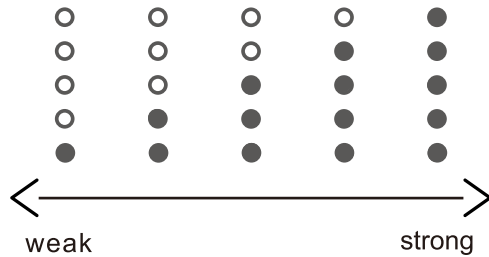

Press " ^ " to increase the water pressure. Each time you press it, it increases by 1 grade up to the highest grade. Press " v " to decrease the water pressure. Each time you press it, it decreases by 1 grade up to the lowest grade.



Water temperature adjustment

There are 5 grades of "Water temperature adjustment".

The default setting is grade 3.

Condition: Rear wash or Lady wash function has been activated.

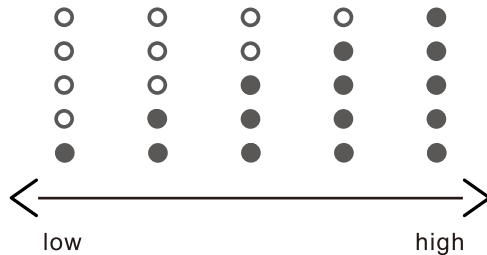

Press " ^ " to increase the water temperature. Each time you press it, it increase by 1 grade up to highest grade. Press " v " to decrease the water temperature. Each time you press it, it decrease by 1 grade up to lowest grade.

3.5 Instructions for temp adjustment on the back of the remote control

1. Remove the remote control from the remote bracket
2. Press 3. Use to select the temperature adjustment item you want to set
4. Use to select the temperature level you want to set

SEAT TEMP SEAT TEMP

OFF

OFF ← LOW → HIGH

There are 6 levels of SEAT TEMP, which are "OFF", 1, 2, 3, 4, and 5 levels.

Press the " < " key to decrease the SEAT TEMP. Each time you press the button, the water temperature will decrease by 1 level until the "OFF" state.

Press the " > " key to increase the Toilet Seat TEMP. Each time you press it, it will increase by 1 level, till to the level 5.

3.6 Descaling reminder setting (back of remote control)

Due to the different degree of the water hardness, scale will form over a long period of accumulation. After the toilet is installed, it is necessary to use the "water hardness test paper" (included in the package) to test the local water quality.

The test method as follow:

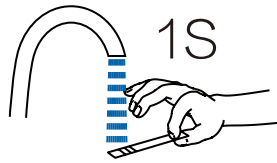

ppm(gpg) (Please refer to the actual color card)

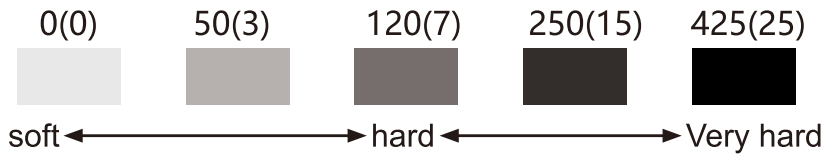

Measure the water quality at the installation site, immerse the reaction area in the test solution for 1 second, and remove excess water drops;
 After 15 seconds, compare the color of the test paper with the standard card (please refer to the actual color card). The test paper color is close to which standard, and that is your water concentration value.
 Set the descaling reminder conditions on the back of the remote control according to the concentration value.
 If the reading is between two grades, select the higher grade.
 Setting method (example: when the concentration value is 120ppm, descaling reminder once):

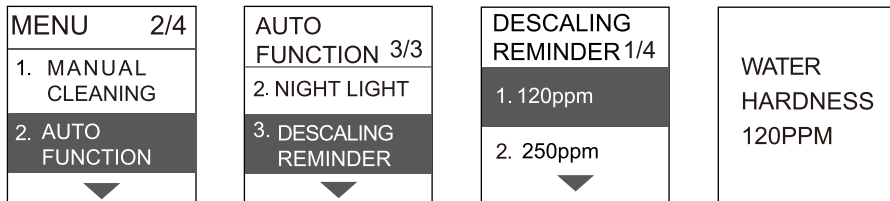

When it's time for descaling, the descaling reminder light flashes , please add descaling liquid to descale the product (see page 31-32 for details).

Chapter 4 Cleaning and Maintenance.

4.1 Toilet seat unit cleaning

Clean the seat unit regularly, or immediately after being stained with dirt. If not cleaned regularly, the dirt may become noticeable, and become stubborn.

Be sure to cut off the power supply before cleaning the surface of the product. Do not put water or detergent into the product or the power plug, which may cause short circuit, electric shock, or fire.

Attention: discoloration, yellowing or peeling of paint due to improper cleaning.

- Do not use corrosive cleaners or cleaners containing chlorine or acids.
- Use only cleaning agents and equipment specific to this application.
- Follow the detergent instructions.
- Never mix detergents.

Wipe with a soft damp cloth. A neutral soap solution is an ideal daily cleaner.

4.2 Nozzle cleaning

The nozzle will retract automatically for self-cleaning before and after cleaning function.

- Manually clean the nozzle.

Clean the nozzles regularly or immediately after dirt is found.

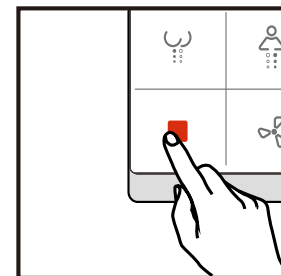

1. Press and hold the "Stop" button to ensure the toilet is not working.

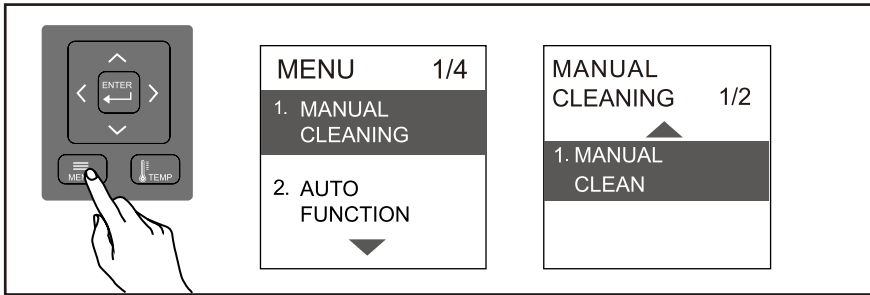

2. Activate the nozzle cleaning according to the above operation on the back of the remote control. The nozzle is extended without water.

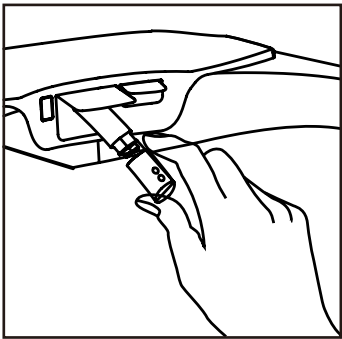

3. Remove the spray head, and clean the spray head with a cloth, sponge or brush and neutral detergent.

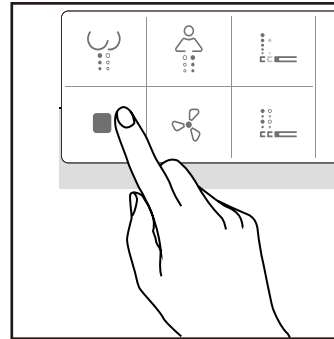

4. Put back the cleaned spray head, click "Stop" on the front of the remote control again to end, and the nozzle will retract .

4.3 Remote control cleaning

Clean the remote control and remote control bracket with a soft, damp cloth.

4.4 Deodorizing device cleaning

1. When there is too much dust on the deodorization box, the amount of inhaled air will decrease. Please use a toothbrush or a small brush to remove the dust. The specific steps as follow :

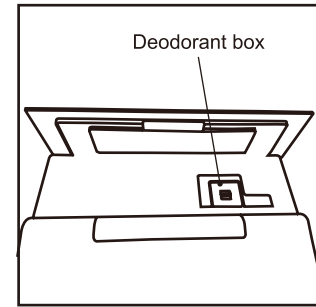

① . Open the glass cover on the rear of the product.

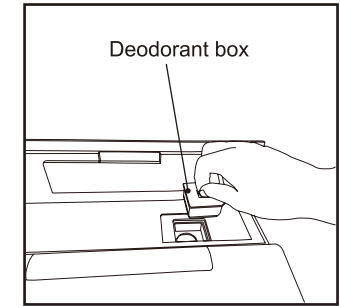

② . Remove the deodorant box.

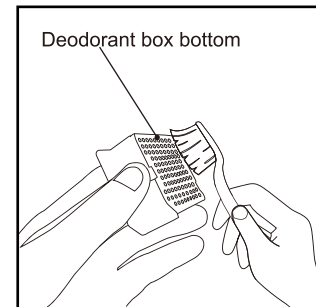

③ . Use a toothbrush or a brush to clean the bottom of the deodorant box until there is no dust or paper dust.

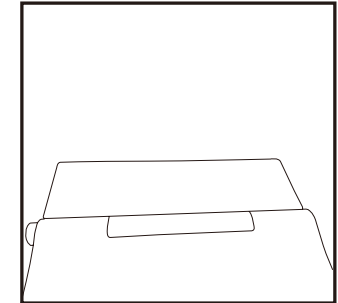

④ . Put the cleaned deodorant box back into the groove, and cover the glass cover again.

Do not wash the deodorant box with water, otherwise the deodorizing effect will be lost.

Placing the deodorant box in the sun for several hours can extend the life of the deodorant.

2. After cleaning the deodorant box and the deodorizing suction port, if there is still odor generated, Please replace the deodorant

The specific operations as follow :

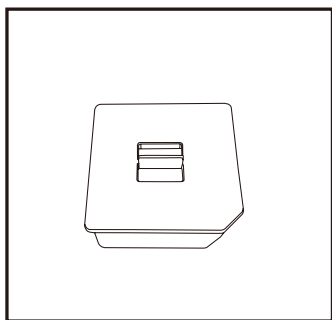

① . Remove the deodorant box from the back of the product.

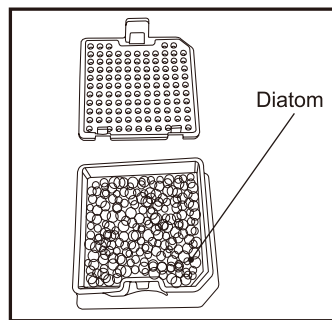

② . Open the deodorant box.

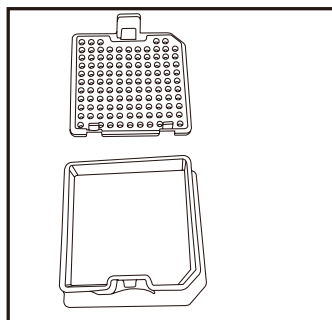

③ . Remove the old diatom from the box.

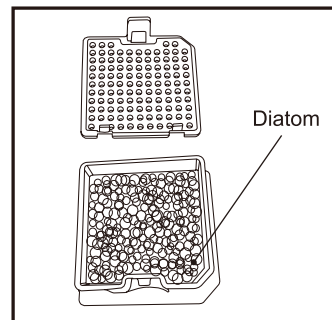

④ . Replace with new diatom.

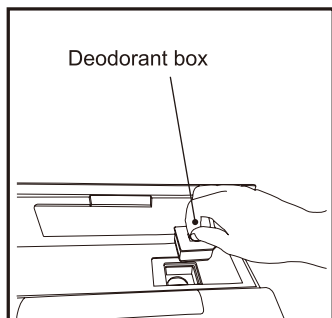

⑤ . Put the new box back into the groove of the product.

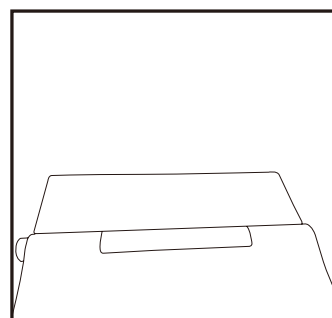

⑥ . Close the glass cover.

4.5 Descaling

Due to the different hardness of water, scale will be formed during long-term accumulation, regular descaling is required. The descaling steps as follow :

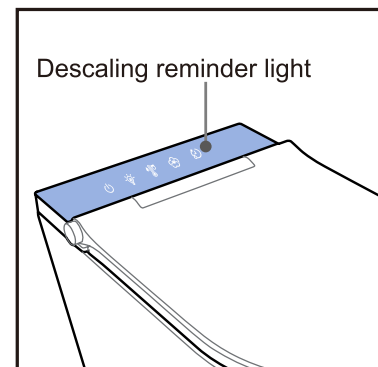

1. Open the rear glass cover.

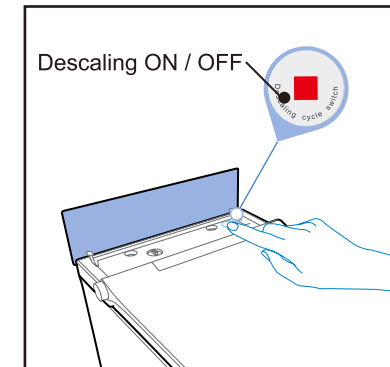

2. Press the descaling button and start the water tank drainage; the nozzle will self- clean during the drainage process, accompanied by drops beep. If misoperation, the product can be used normally after power off and restart.

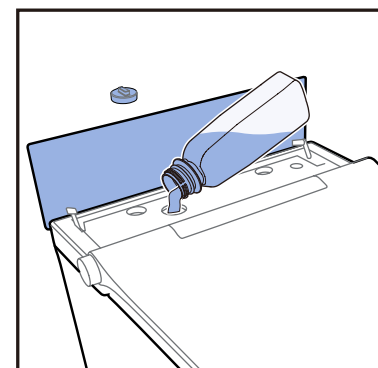

3. After the water in the tank is drained out completely; add the scale remover (recommend coffee machine scale remover); the maximum capacity is 250ml.

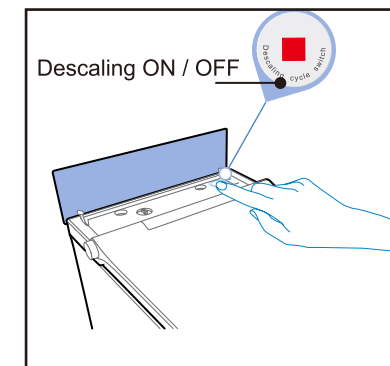

4. Press the descaling button again to start the descaling cycle.

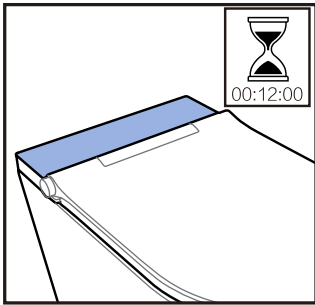

5. During the descaling process, the status lamp flashes. After 9 minutes, the descaling cycle is completed and the status lamp comes back to normal.

Note: Scale remover shall be purchased by the users. It is recommended to purchase the coffee machine scale remover (it can only be used for cleaning scale, not for other purposes, please keep away from the children).

4.6 Waste disposal

Electrical and electronic equipment may contain hazardous substances. Do not discard it as unsorted household waste. Please send it to the designated collection point. In this way, you can contribute to resource conservation and environmental protection. Contact your retailer or local authorities for more information.

Used batteries must be disposed of properly. Battery recycling bins with corresponding labels are available in battery stores and community collection stations.

To avoid possible suffocation injury or danger, do not allow children to play with plastic bags and product packaging. Please keep such packaging materials safely or discard them in an environmentally friendly manner. If possible, keep the packing materials until the end of the warranty period.

4.7 Product maintenance

In the following cases, please close the water inlet valve and remove the hose to drain the water.

- Water may freeze in cold areas.
- Not used for a long time.

It may cause skin infection due to deterioration of residual water.

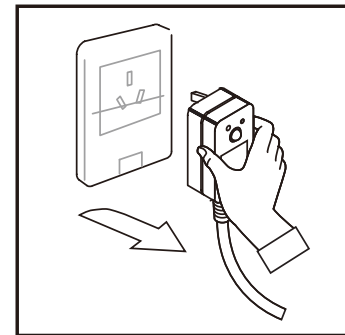

1. Disconnect the power supply and pull out the power plug.

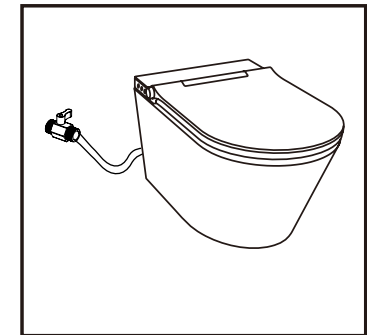

2. Close the valve and stop supplying water to the system.

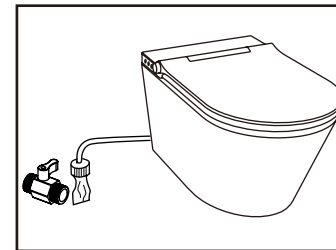

3. Remove the water inlet hose from the water inlet valve and drain the water from the hose.

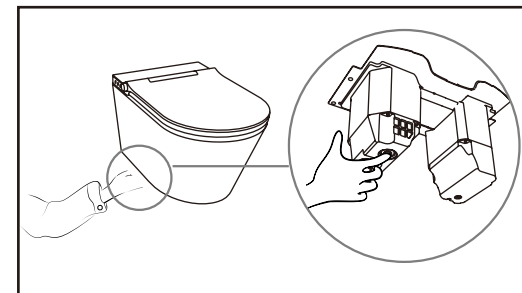

4. Water quality conditions are different in different regions. Please clean the water tank regularly. Blocking of dirt may cause the water flow to decrease. (Recommended once every 2-6 months). Drain the water in the water tank by pressing the drain button under the water tank. (As shown in FIG).

4.8 Winter product maintenance

When freezing may occur in winter, etc., in order to prevent damage to the hose or product from freezing, please take measures to prevent freezing:

- a. Increase the room temperature;
- Close the water inlet angle valve and drain the water from the water inlet hose

Chapter 5 Troubleshooting

Recommendation: Initial basic operation in case of failure
Turn off the main power of the product, and reconnect it at least 3 hours later.

If your device still does not work properly after following the instructions described below, please contact our customer service center or your dealer.

Problem	Potential cause	Solution
Basic function		
Function does not work at all	Power off	Connect to main supply
	Plug loose or poor connect	Please plug in to ensure the power is restored
	The leakage protection button of the power cord is not on	Please turn it on
	In standby mode	Switch to startup mode
Water leakage	Malfunction	Close main valve Disconnect the power supply. Call Customer Service Hotline
Remote control		
During operation, the indicator light of remote control keeps flashing	Low battery indication	Change the battery

Problem	Potential cause	Solution
The remote control does not work	No battery inserted	Load the battery
	The battery is flat	Change the battery
	Battery is positive and negative	Load the battery correctly
	Defective remote control	Call Customer Service Hotline



Warning

Do not disassemble, repair or modify the product by yourself. It may cause electric shock, fire or malfunction.

Problem	Potential cause	Solution
Rear wash / Lady wash		
It takes too long to switch between rear wash and lady wash	When switching between rear wash and lady wash, the spray wand needs to be retracted and selfcleaning before extending again.	Normal
Cleaning nozzle does not protrude	Water inlet hose bent	Exclude water hose bent Call Customer Service Hotline
The cleaning water does not spray out	Water supply was cut off	Please wait for water supply
	Inlet angle valve is not open or is blocked by dirt	Open or clean the inlet angle valve
	Water inlet hose bend	Exclude bent water hose Call Customer Service Hotline
	Nozzle blocked	Cleaning nozzle

Problem	Potential cause	Solution
The remote control does not work	No battery inserted	Load the battery
	The battery is flat	Change the battery
	Wrong installation of battery	Load the battery correctly
	Defective remote control	Call Customer Service Hotline



Warning

Do not disassemble, repair or modify the product by yourself.
It may cause electric shock, fire or malfunction.

Problem	Potential cause	Solution
Rear wash / Lady wash		
It takes too long to switch between rear wash and lady wash	When switching between rear wash and lady wash, the spray wand needs to be retracted and selfcleaning before extending again	Normal
Cleaning nozzle does not extend	Water inlet hose bent	Exclude water hose bent Call Customer Service Hotline
The cleaning water does not spray out	Water supply was cut off	Please wait for water supply
	Inlet angle valve is not open or is blocked by dirt	Open or clean the inlet angle valve
	Water inlet hose bend	Exclude water hose bent Call Customer Service Hotline
	Nozzle blocked	Cleaning nozzle

Problem	Potential cause	Solution
Abnormal water spray	Abnormal operation Malfunction	Power on again after unplugging for one minute Call Customer Service Hotline
Water spray intensity is too weak	Water spray intensity has been set to "1" grade	Adjust the water spray intensity to 2, 3, 4 or 5 grade
	Nozzle blocked	Cleaning spout
	Inlet water filter blocked	Cleaning the decompression valve filter
	Water inlet hose deformation	Call Customer Service Hotline
The water temperature is not high enough	Water temperature has been set to "Off" or "1" grade	Set the water temperature to 2, 3, 4 grade
Water temperature is too high	Water temperature has been set to "5" grade	Set the water temperature to 1,2, 3, grade
Nozzle suddenly stopped spraying water	The function stops automatically after 3 minutes	Normal
Retracted nozzle drips water	The nozzle is automatically cleaned before and after the cleaning function	Normal

In the following cases, be sure to contact the service center.

After reinserting the power plug, the indicator light on the toilet body is still blinking. (Please unplug)

After reinserting the power, the indicator light on the toilet body is still off.

When smoking or abnormal sound occurs. (Please unplug the power plug)

Chapter 6 Technical Data

Item		IN.200, IN.300 ET.200, ET.300
Water inlet hose		G1/2 & G3/8
Applicable voltage		AC220V-240V, 50/60HZ
Power		1350W
Length of wire		1.8m
Applicable range of water pressure		70-500 KPA
Suitable intake temperature		4 ~ 30°C
Applicable ambient temperature		4 ~ 40°C
Waterproof grade		IPX4
Flushing device	Flushing flow rate	540 ~ 770mL/min
	Water temperature	Off, 32 ~ 40°C
	Flushing cycle	3 mins
	Warm water heating method	Instant heater heating
	Maximum heating power	1400W
	Safety device	Temperature fuse, level switch, thermostat
	Anti-backflow device	air break
Drying device	Maximum wind speed	5m/S
	Maximum heating power	230W
	Drying cycle	4 mins
	Warm wind temperature	Off, 40 ~ 60°C
	Safety device	temperature Controller, Temperature Fuse
Seat heating	The surface temperature	Off, 35 ~ 39°C
	Heating power	50W
	Safety device	Thermostat, temperature fuse
Deodorization method		Diatom Pure
Other Safety device		Leakage protection
Net weight		38.5Kg (Contains ceramic)
Size		600*370*402 mm (Contains ceramic)

Service card			
Product model			
Factory number		Purchase date	
Dealer		Telephone	
City		Province	
Country		Dealer's stamp	
<p>Maintenance regulations:</p> <ol style="list-style-type: none"> In accordance with the instructions and precautions in use, if a failure occurs after normal use, maintenance will be performed free of charge during the warranty period. Please contact the company's customer service center or the seller for repairs due to failures during the warranty period, and show the service card. Although it is under warranty, the following conditions will be charged for maintenance. <ul style="list-style-type: none"> -Failures due to carelessness or negligence during use, and failures due to improper repair or modification. -Failures or damages due to moving installation location. -Failures and damages caused by fire, earthquake, flood, lightning, and other natural disasters, pollution, or abnormal voltage. -Failures and damages caused by the use of unspecified power sources (voltage, frequency). -Used for purposes other than general domestic use, malfunctions or damage. -This service card cannot be provided. <p>-When the seller information, the installation date, and the seal of the dealer are not filled in this service card or the contents are modified without authorization.</p> <p>-This service card is no longer issued, please keep it properly.</p>			

About service

Customer rights

Customers have the right to get maintenance free of charge if a failure occurs within one year from the date of purchase.

However, if the customer's failure or natural disaster occurs, maintenance will be charged even during the warranty period.

First copy: saved by the customer



Service card	
Product number	
Factory number	
Customer name	
Contact number	
Detailed address	
Seller	
Contact number	
Purchase date	

Second copy: send back to company headquarters

Maintenance records			
Maintenance date	Maintenance project	Maintenance party	Signature of maintenance staff

