

# LARS

**BLACKS**  
*of SOPWELL*  
FURNITURE & INTERIORS



UPHOLSTERY



COMFORTS



COVERS

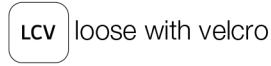

SPECIAL



**loose cover elements**

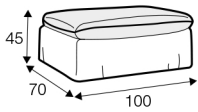

footstool 100x70

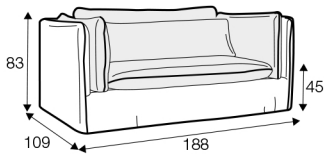

2 seater

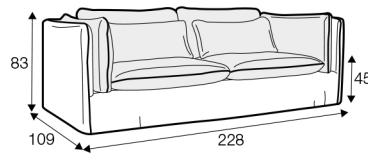

3 seater

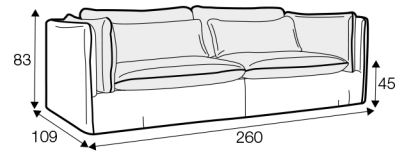

3,5 seater divided

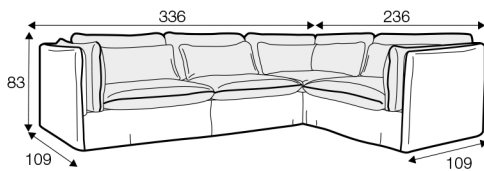

example of set

element 130 left / or right + element 100 without armrests  
+ corner 90° + element 130 right / or left

**loose cover with velcro elements**

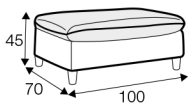

footstool 100x70

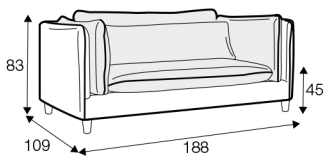

2 seater

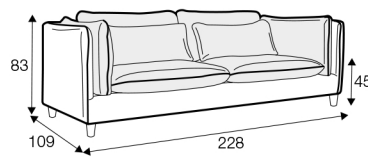

3 seater

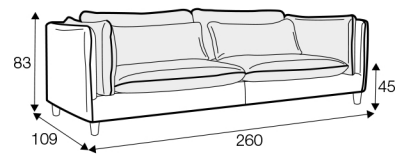

3,5 seater divided

**modular system**

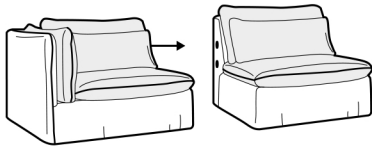

**elements of the modular system loose cover**

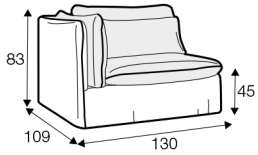

element 130  
left / or right

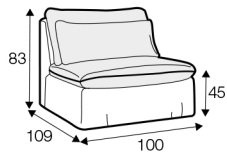

element 100  
left / or right  
without armrests

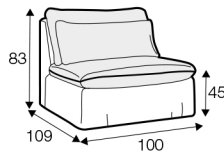

element 100  
without armrests

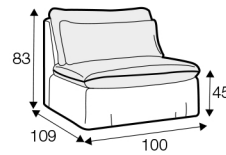

element 100  
without armrests  
freestanding

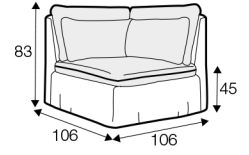

corner 90°

**loose cover with velcro elements**

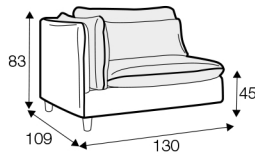

element 130  
left / or right

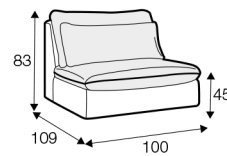

element 100  
left / or right  
without armrests

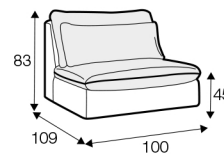

element 100  
without armrests

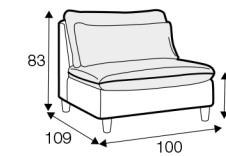

element 100  
without armrests  
freestanding

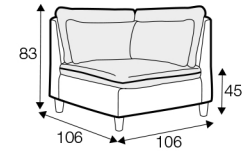

corner 90°

**extra dimensions**

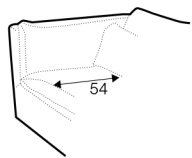

**legs**

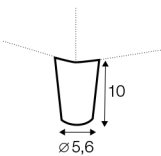

no. 58A  
wood

## profile

---

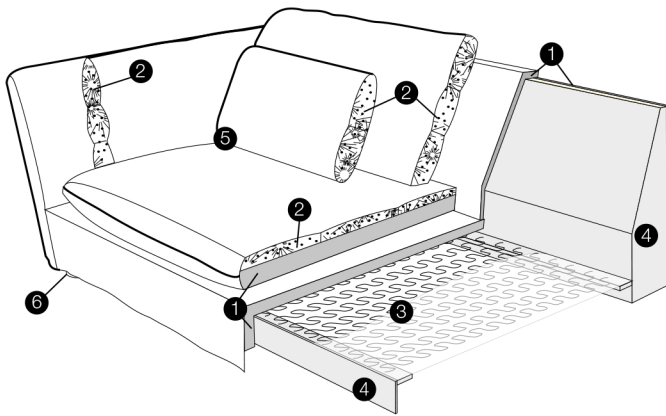

### lux

1. polyurethane foam/ high resilient polyurethane foam
2. cushion chamber with mix of feather and silicone balls
3. springs
4. solid wood and wood based elements
5. fabric
6. solid wood legs