

Anders

BLACKS
of SOPWELL



Anders

BLACKS
of SOPWELL

UPHOLSTERY



COMFORTS



COVERS

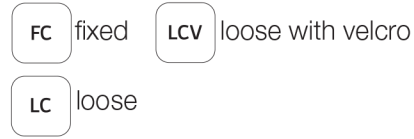

SPECIAL



Drawing show combinations with armrest I. Combinantons with other armrest are properly longer or shorter in width.

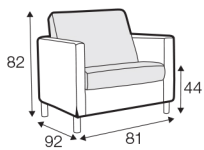

armchair

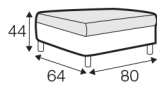

footstool 80x64

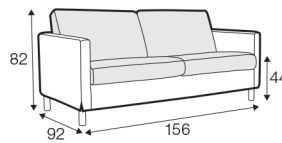

2 seater

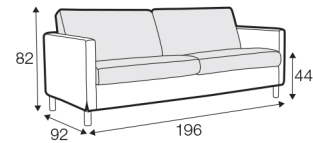

2,5 seater

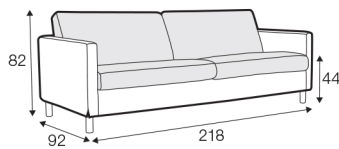

3 seater

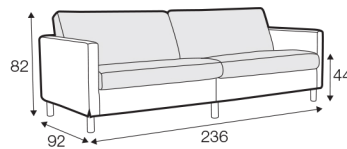

4 seater divided

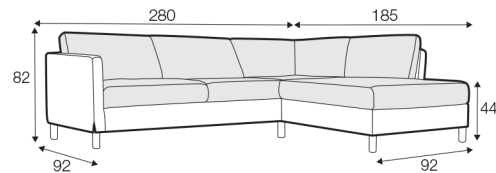

set 4 right / or left
2,5 seater left / or right + divan right / or left

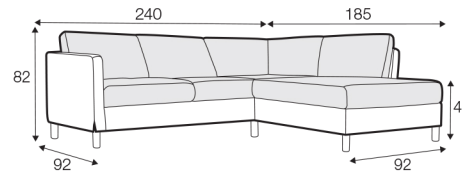

set 5 right / or left
2 seater left / or right + divan right / or left

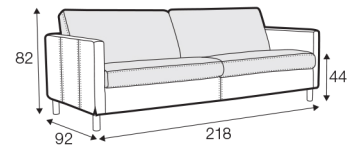

example of leather cover
3 seater

modular system

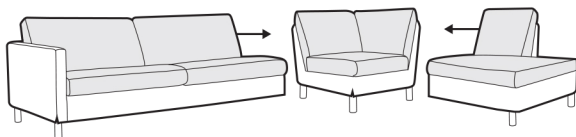

elements of the modular system

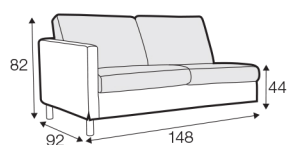

2 seater left / or right

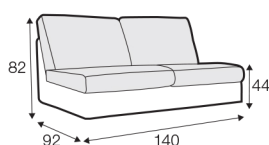

2 seater
without armrests

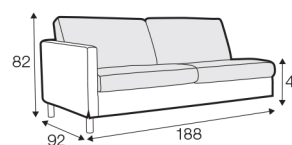

2,5 seater left / or right

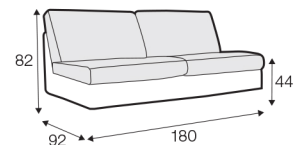

2,5 seater
without armrests

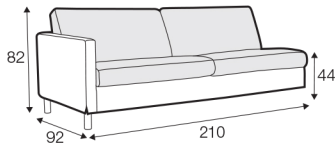

3 seater left / or right

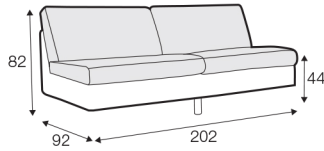

3 seater without armrests

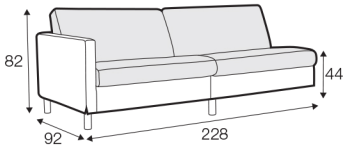

4 seater divided left / or right

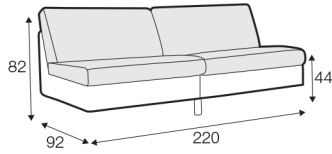

4 seater divided without armrests

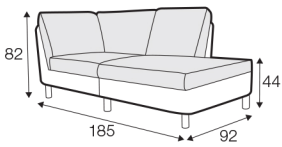

divan right / or left

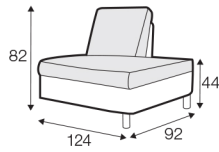

bench right / or left

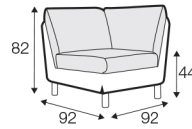

corner 90°

extra dimensions

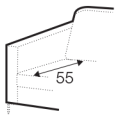

depth of seat

accessories

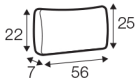

cushion

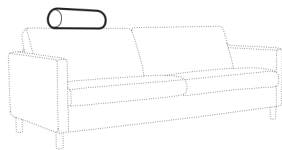

headrest with roll L-60

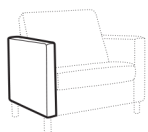
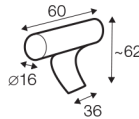

armrest I

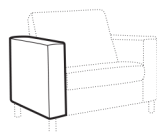
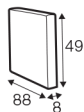

armrest II

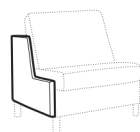
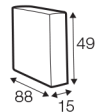

endpart left / or right



legs

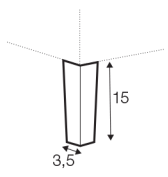

no. 109
wood

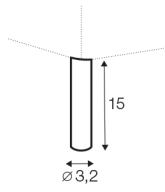

no. 195
metal chrome,
painted black

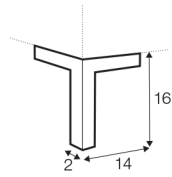

no. 47
metal chrome,
painted black

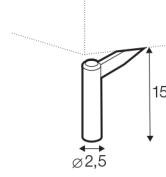

no. 145A
metal chrome,
painted black

All legs can be fixed to both armrests:

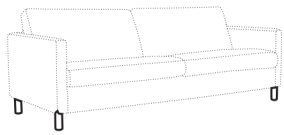

under armrest

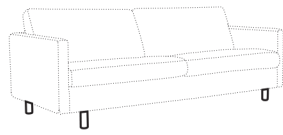

under frame

profile

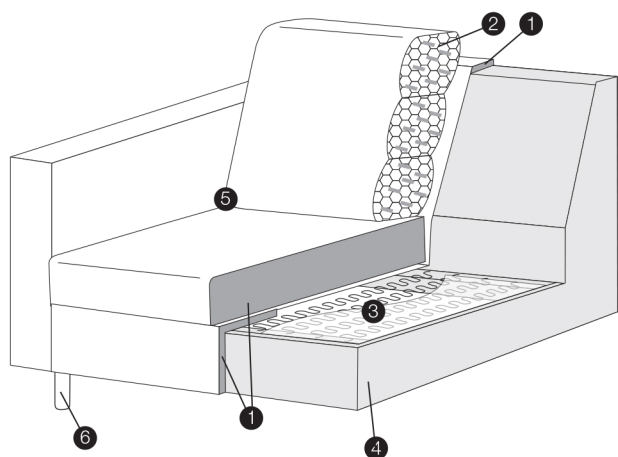

standard

1. polyurethane foam/ high resilient polyurethane foam
2. foam flakes with silicone balls
3. springs
4. solid wood and wood based elements
5. fabric or leather
6. solid wood or metal legs

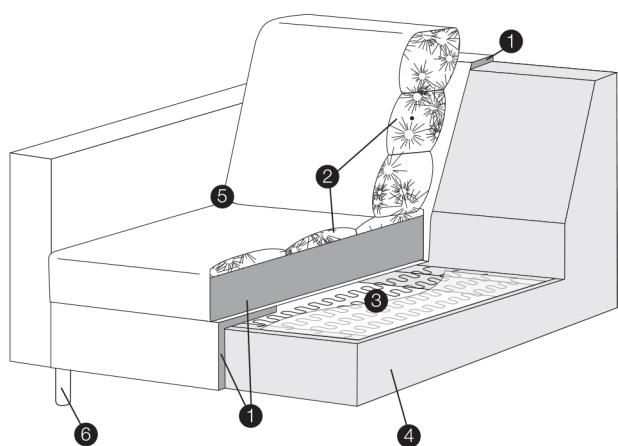

lux

1. polyurethane foam/ high resilient polyurethane foam
2. cushion chamber with mix of feather and silicone balls
3. springs
4. solid wood and wood based elements
5. fabric or leather
6. solid wood or metal legs