

CDC PLASTIC PUSH-IN CONNECTORS



565

CDC
FluidFit Fittings



574

CDC
One Touch 20 Bar Fittings



576

CDC
One Touch Fittings



591

CDC
One Touch Fittings Kits



594

CDC
Compact One Touch Fittings



597

CDC
Speed Controllers - Meter-Out



601

CDC
Speed Controllers with Pilot Check Valves



602

CDC
Silencers



603

CDC
Hand Valves / Hand Slide Valves

CDC PLASTIC PUSH-IN CONNECTORS



605 CDC Stop Fittings



606 CDC Check Valves



607 CDC Two Touch Fittings
Blow Gun



607 CDC Blow Guns



608 CDC Coolant Line System



610 CDC Polyurethane Tube



612 CDC Polyurethane Airline Recoils



613 CDC Polyethylene Tube



613 CDC Tube Cutters

FEATURES

- Fluidfit products are designed for water, food and air contact but can be used with selected gases, vacuum and liquids
- Easy actions allow the tube to be connected and released quickly, saving time and expenses
- Fluidfit products are made from NSF and ACS approved non-toxic materials

FLUID TYPES

- Water
- Beverages
- Vacuum
- Compressed air
- Gases and liquids suitable with construction materials

WORKING PRESSURES & TEMPERATURES

Working temperatures from -20°C to +98°C dry air, from 1°C to 98°C air and fluids* Pressure up to 20 bar depending on tubes and temperatures applied.

Ø / °C	-20°C	1°C*	25°C*	70°C*	98°C
4 mm 5/32"	0 bar to 8 bar with dry air only	20 bar	20 bar	16 bar	10 bar
6 mm 3/16" 1/4"		20 bar	20 bar	16 bar	10 bar
8 mm 5/16"		20 bar	20 bar	16 bar	10 bar
10 mm 3/8"		16 bar	16 bar	14 bar	10 bar
12 mm 1/2"		14 bar	14 bar	8 bar	6 bar

*Temperatures and pressures indicated refer to NSF standards limits. Please contact our technical sales department for higher temperature and/or pressure application needs.

System performances always depend on fittings, tubes and other possible items and accessories used. Users must cross check the technical features of EACH component in order to avoid possible failures and damages.

TUBE TYPE

PLASTIC - Polyethylene (PE), Polyamide (PA), Polyurethane (PU), PTFE, FEP

SOFT METAL - Brass, Copper, Mild steel

HARD METAL - Please contact our technical sales department for stainless steel and other hard metal tubes.

MAXIMUM TORQUE VALUES

Maximum torque values for BSP, BSPT and NPT plastic threads

Threads	1/8"	1/4"	3/8"	1/2"
Max. torque	1.5 Nm	1.5 Nm	3.0 Nm	3.0 Nm

CERTIFICATIONS & CONFORMITY



MATERIALS

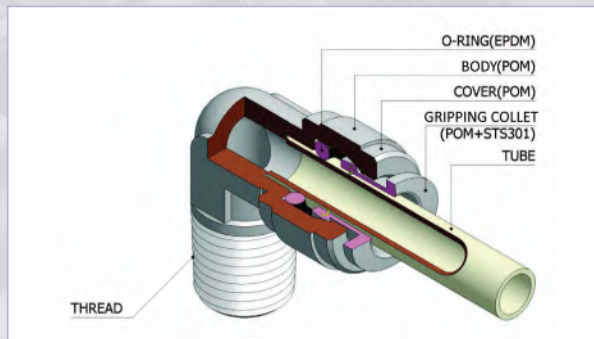



HPC STRAIGHT ADAPTOR



3720

PART NUMBER	TUBE OD	MALE THREAD	PRICE EACH	
			1 - 9	10 +
CDHPC0401	4 mm	1/8" BSPT	£1.04	£0.91
CDHPC0601	6 mm	1/8" BSPT	£1.04	£0.91
CDHPC0602	6 mm	1/4" BSPT	£1.01	£0.89
CDHPC0603	6 mm	3/8" BSPT	£1.16	£1.02
CDHPC0801	8 mm	1/8" BSPT	£1.04	£0.91
CDHPC0802	8 mm	1/4" BSPT	£1.06	£0.92
CDHPC0803	8 mm	3/8" BSPT	£1.18	£1.04
CDHPC1003	10 mm	3/8" BSPT	£1.15	£1.01
CDHPC1004	10 mm	1/2" BSPT	£1.20	£1.06
CDHPC1203	12 mm	3/8" BSPT	£1.21	£1.07
CDHPC1204	12 mm	1/2" BSPT	£1.23	£1.08



HCF-NH FEMALE TAP CONNECTOR

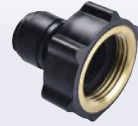

3720

PART NUMBER	TUBE OD	FEMALE THREAD	PRICE EACH	
			1 - 9	10 +
CDHCF06-NH06	6 mm	3/4" BSPP	£5.77	£5.06
CDHCF08-NH06	8 mm	3/4" BSPP	£5.90	£5.17
CDHCF10-NH06	10 mm	3/4" BSPP	£6.02	£5.28



HPC-G STRAIGHT ADAPTOR



3720

PART NUMBER	TUBE OD	MALE THREAD	PRICE EACH	
			1 - 9	10 +
CDHPC04G01	4 mm	1/8" BSPP	£0.96	£0.84
CDHPC04G02	4 mm	1/4" BSPP	£0.99	£0.88
CDHPC06G01	6 mm	1/8" BSPP	£1.09	£0.97
CDHPC06G02	6 mm	1/4" BSPP	£1.10	£0.97
CDHPC08G01	8 mm	1/8" BSPP	£1.15	£1.01
CDHPC08G02	8 mm	1/4" BSPP	£1.16	£1.01
CDHPC08G03	8 mm	3/8" BSPP	£1.16	£1.02
CDHPC08G04	8 mm	1/2" BSPP	£1.20	£1.06
CDHPC10G02	10 mm	1/4" BSPP	£1.23	£1.08
CDHPC10G03	10 mm	3/8" BSPP	£1.24	£1.09
CDHPC10G04	10 mm	1/2" BSPP	£1.29	£1.14
CDHPC12G03	12 mm	3/8" BSPP	£1.33	£1.17
CDHPC12G04	12 mm	1/2" BSPP	£1.43	£1.26
CDHPC15G04	15 mm	1/2" BSPP	£2.31	£2.03
CDHPC15G06	15 mm	3/4" BSPP	£3.31	£2.90
CDHPC22G06	22 mm	3/4" BSPP	£4.07	£3.58



HCJ STEM ADAPTOR



3720

PART NUMBER	STEM OD	MALE THREAD	PRICE EACH	
			1 - 9	10 +
CDHCJ0401	4 mm	1/8" BSPT	£0.61	£0.54
CDHCJ0402	4 mm	1/4" BSPT	£0.61	£0.54
CDHCJ0601	6 mm	1/8" BSPT	£0.63	£0.55
CDHCJ0602	6 mm	1/4" BSPT	£0.64	£0.56
CDHCJ0801	8 mm	1/8" BSPT	£0.61	£0.54
CDHCJ0802	8 mm	1/4" BSPT	£0.64	£0.56
CDHCJ0803	8 mm	3/8" BSPT	£0.67	£0.59
CDHCJ1002	10 mm	1/4" BSPT	£0.67	£0.59
CDHCJ1003	10 mm	3/8" BSPT	£0.69	£0.61
CDHCJ1004	10 mm	1/2" BSPT	£0.76	£0.67
CDHCJ1203	12 mm	3/8" BSPT	£0.77	£0.68
CDHCJ1204	12 mm	1/2" BSPT	£0.84	£0.74



HCF-G FEMALE STRAIGHT



3720

PART NUMBER	TUBE OD	FEMALE THREAD	PRICE EACH	
			1 - 9	10 +
CDHCF04G01	4 mm	1/8" BSPP	£1.33	£1.16
CDHCF06G01	6 mm	1/8" BSPP	£1.18	£1.05
CDHCF06G02	6 mm	1/4" BSPP	£1.23	£1.08
CDHCF06G03	6 mm	3/8" BSPP	£1.34	£1.17
CDHCF08G01	8 mm	1/8" BSPP	£1.27	£1.12
CDHCF08G02	8 mm	1/4" BSPP	£1.33	£1.17
CDHCF08G03	8 mm	3/8" BSPP	£1.30	£1.15
CDHCF08G04	8 mm	1/2" BSPP	£1.53	£1.34
CDHCF08G06	8 mm	3/4" BSPP	£5.08	£4.45
CDHCF10G02	10 mm	1/4" BSPP	£1.43	£1.25
CDHCF10G03	10 mm	3/8" BSPP	£1.48	£1.30
CDHCF10G04	10 mm	1/2" BSPP	£1.55	£1.37
CDHCF10G06	10 mm	3/4" BSPP	£5.50	£4.82
CDHCF12G02	12 mm	1/4" BSPP	£1.43	£1.25
CDHCF12G03	12 mm	3/8" BSPP	£1.56	£1.37
CDHCF12G04	12 mm	1/2" BSPP	£1.57	£1.38
CDHCF15G06	15 mm	3/4" BSPP	£3.58	£3.14



HCJ-G STEM ADAPTOR



3720

PART NUMBER	STEM OD	MALE THREAD	PRICE EACH	
			1 - 9	10 +
CDHCJ04G01	4 mm	1/8" BSPP	£0.61	£0.54
CDHCJ04G02	4 mm	1/4" BSPP	£0.63	£0.56
CDHCJ06G01	6 mm	1/8" BSPP	£0.63	£0.56
CDHCJ06G02	6 mm	1/4" BSPP	£0.65	£0.58
CDHCJ08G01	8 mm	1/8" BSPP	£0.65	£0.58
CDHCJ08G02	8 mm	1/4" BSPP	£0.67	£0.59
CDHCJ08G03	8 mm	3/8" BSPP	£0.70	£0.62
CDHCJ10G02	10 mm	1/4" BSPP	£0.71	£0.62
CDHCJ10G03	10 mm	3/8" BSPP	£0.77	£0.68
CDHCJ10G04	10 mm	1/2" BSPP	£0.82	£0.72
CDHCJ12G03	12 mm	3/8" BSPP	£0.83	£0.73
CDHCJ12G04	12 mm	1/2" BSPP	£0.87	£0.77
CDHCJ15G04	15 mm	1/2" BSPP	£1.40	£1.23



HMM
BULKHEAD



3720

PART NUMBER	TUBE OD	PRICE EACH	
		1 - 9	10 +
CDHMM0404	4 mm	£1.51	£1.32
CDHMM0606	6 mm	£1.54	£1.35
CDHMM0808	8 mm	£1.63	£1.43
CDHMM1010	10 mm	£1.88	£1.65
CDHMM1212	12 mm	£2.25	£1.97

REDUCING BULKHEAD

PART NUMBER	TUBE OD	TUBE OD	PRICE EACH	
			1 - 9	10 +
CDHMM0604	6 mm	4 mm	£1.71	£1.50
CDHMM0806	8 mm	6 mm	£1.86	£1.63

B



A



HLJ
STEM ELBOW

3720

PART NUMBER	STEM OD (A)	TUBE OD (B)	PRICE EACH	
			1 - 9	10 +
CDHLJ0404	4 mm	4 mm	£1.00	£0.88
CDHLJ0606	6 mm	6 mm	£1.08	£0.96
CDHLJ0808	8 mm	8 mm	£1.15	£1.00
CDHLJ1010	10 mm	10 mm	£1.16	£1.02
CDHLJ1212	12 mm	12 mm	£1.30	£1.15
CDHLJ1515	15 mm	15 mm	£2.54	£2.23

REDUCING STEM ELBOW

PART NUMBER	STEM OD	TUBE OD	PRICE EACH	
			1 - 9	10 +
CDHLJ0608	6 mm	8 mm	£1.18	£1.04
CDHLJ1006	10 mm	6 mm	£1.27	£1.12
CDHLJ1008	10 mm	8 mm	£1.33	£1.17



HUC
EQUAL UNION STRAIGHT



3720

PART NUMBER	TUBE OD	PRICE EACH	
		1 - 9	10 +
CDHUC0404	4 mm	£1.07	£0.93
CDHUC0606	6 mm	£1.14	£1.00
CDHUC0808	8 mm	£1.28	£1.12
CDHUC1010	10 mm	£1.43	£1.26
CDHUC1212	12 mm	£1.48	£1.30
CDHUC1515	15 mm	£2.79	£2.46
CDHUC2222	22 mm	£4.17	£3.67

REDUCING UNION STRAIGHT

PART NUMBER	TUBE OD	TUBE OD	PRICE EACH	
			1 - 9	10 +
CDHUC0604	6 mm	4 mm	£1.16	£1.02
CDHUC0605	6 mm	5 mm	£1.18	£1.04
CDHUC0806	8 mm	6 mm	£1.30	£1.15
CDHUC1006	10 mm	6 mm	£1.42	£1.25
CDHUC1008	10 mm	8 mm	£1.43	£1.25
CDHUC1210	12 mm	10 mm	£1.47	£1.29



HPL
RIGID ELBOW



3720

PART NUMBER	TUBE OD	MALE THREAD	PRICE EACH	
			1 - 9	10 +
CDHPL0401	4 mm	1/8" BSPT	£1.06	£0.93
CDHPL0601	6 mm	1/8" BSPT	£1.04	£0.91
CDHPL0602	6 mm	1/4" BSPT	£1.05	£0.91
CDHPL0603	6 mm	3/8" BSPT	£1.12	£1.01
CDHPL0802	8 mm	1/4" BSPT	£1.09	£0.97
CDHPL0803	8 mm	3/8" BSPT	£1.16	£1.01
CDHPL1002	10 mm	1/4" BSPT	£1.20	£1.06
CDHPL1003	10 mm	3/8" BSPT	£1.12	£0.99
CDHPL1202	12 mm	1/4" BSPT	£1.30	£1.15
CDHPL1203	12 mm	3/8" BSPT	£1.87	£1.64
CDHPL1204	12 mm	1/2" BSPT	£1.30	£1.15



HGJ
STEM REDUCER



3720

PART NUMBER	TUBE OD (A)	STEM OD (B)	PRICE EACH	
			1 - 9	10 +
CDHGJ0604	6 mm	4 mm	£0.88	£0.78
CDHGJ0804	8 mm	4 mm	£1.42	£1.25
CDHGJ0806	8 mm	6 mm	£0.93	£0.82
CDHGJ0810	8 mm	10 mm	£1.12	£0.99
CDHGJ1006	10 mm	6 mm	£1.12	£0.99
CDHGJ1008	10 mm	8 mm	£1.12	£0.99
CDHGJ1208	12 mm	8 mm	£1.84	£1.61
CDHGJ1210	12 mm	10 mm	£1.87	£1.64
CDHGJ1510	15 mm	10 mm	£1.86	£1.64
CDHGJ1512	15 mm	12 mm	£1.86	£1.64



HUL
EQUAL ELBOW



3720

PART NUMBER	TUBE OD	PRICE EACH	
		1 - 9	10 +
CDHUL0404	4 mm	£1.15	£1.00
CDHUL0606	6 mm	£1.17	£1.04
CDHUL0808	8 mm	£1.24	£1.09
CDHUL1010	10 mm	£1.29	£1.14
CDHUL1212	12 mm	£1.36	£1.19
CDHUL1515	15 mm	£3.13	£2.75
CDHUL2222	22 mm	£5.85	£5.13

REDUCING ELBOW

PART NUMBER	TUBE OD	TUBE OD	PRICE EACH	
			1 - 9	10 +
CDHUL0804	8 mm	4 mm	£1.48	£1.30
CDHUL0806	8 mm	6 mm	£1.22	£1.07
CDHUL1006	10 mm	6 mm	£1.74	£1.52
CDHUL1008	10 mm	8 mm	£1.33	£1.17
CDHUL1206	12 mm	6 mm	£1.37	£1.20
CDHUL1208	12 mm	8 mm	£1.36	£1.19
CDHUL1210	12 mm	10 mm	£1.74	£1.52



HUT
EQUAL TEE



3720

PART NUMBER	TUBE OD	PRICE EACH	
		1 - 9	10 +
CDHUT0404	4 mm	£1.43	£1.26
CDHUT0606	6 mm	£1.51	£1.33
CDHUT0808	8 mm	£1.58	£1.39
CDHUT1010	10 mm	£1.81	£1.60
CDHUT1212	12 mm	£1.89	£1.66
CDHUT1515	15 mm	£4.42	£3.88
CDHUT2222	22 mm	£8.02	£7.05



HPP
PLUG



3720

PART NUMBER	TUBE OD	PRICE EACH	
		1 - 9	10 +
CDHPP04	4 mm	£0.41	£0.36
CDHPP06	6 mm	£0.44	£0.40
CDHPP08	8 mm	£0.46	£0.41
CDHPP10	10 mm	£0.48	£0.42
CDHPP12	12 mm	£0.65	£0.57
CDHPP15	15 mm	£0.79	£0.69
CDHPP22	22 mm	£0.97	£0.86

REDUCING TEE

PART NUMBER	TUBE OD	TUBE OD	TUBE OD	PRICE EACH	
				1 - 9	10 +
CDHUT100610	10 mm	6 mm	10 mm	£1.83	£1.61
CDHUT121012	12 mm	10 mm	12 mm	£1.81	£1.58
CDHUT221222	22 mm	12 mm	22 mm	£7.59	£6.65
CDHUT221522	22 mm	15 mm	22 mm	£7.63	£6.69



HUY
EQUAL UNION Y

3720

PART NUMBER	TUBE OD (A)	TUBE OD (B)	PRICE EACH	
			1 - 9	10 +
CDHUY0404	4 mm	4 mm	£1.54	£1.35
CDHUY0606	6 mm	6 mm	£1.64	£1.44
CDHUY0808	8 mm	8 mm	£1.74	£1.53
CDHUY1008	10 mm	8 mm	£2.04	£1.80
CDHUY1010	10 mm	10 mm	£1.93	£1.70
CDHUY1212	12 mm	12 mm	£2.00	£1.75



HPF
END CAP



3720

PART NUMBER	TUBE OD	PRICE EACH	
		1 - 9	10 +
CDHPP06	6 mm	£1.02	£0.90
CDHPP08	8 mm	£1.05	£0.92
CDHPP10	10 mm	£1.21	£1.06
CDHPP12	12 mm	£1.31	£1.15
CDHPP15	15 mm	£1.66	£1.46
CDHPP22	22 mm	£2.14	£1.88



HZA
METRIC EQUAL CROSS



3720

PART NUMBER	TUBE OD	PRICE EACH	
		1 - 9	10 +
CDHZA0606	6 mm	£2.67	£2.34



HCP
CLIP



3720

PART NUMBER	TUBE OD	PRICE EACH	
		1 - 9	10 +
CDHCP04	4 mm	£0.09	£0.08
CDHCP05	5 mm	£0.09	£0.08
CDHCP06	6 mm	£0.09	£0.08
CDHCP08	8 mm	£0.09	£0.08
CDHCP10	10 mm	£0.09	£0.08
CDHCP12	12 mm	£0.09	£0.08



HRPL
BSPT SWIVEL ELBOW



3720

PART NUMBER	TUBE	MALE THREAD	PRICE EACH	
			1 - 9	10 +
CDHRPL0601	6 mm	1/8" BSPT	£1.80	£1.58
CDHRPL0602	6 mm	1/4" BSPT	£1.81	£1.59
CDHRPL0801	8 mm	1/8" BSPT	£1.84	£1.62
CDHRPL0802	8 mm	1/4" BSPT	£1.87	£1.64
CDHRPL0803	8 mm	3/8" BSPT	£1.89	£1.66
CDHRPL1003	10 mm	3/8" BSPT	£1.98	£1.74



HRST
BSPT SWIVEL RUN TEE



3720

PART NUMBER	TUBE	MALE THREAD	PRICE EACH	
			1 - 9	10 +
CDHRST0601	6 mm	1/8" BSPT	£2.13	£1.87
CDHRST0602	6 mm	1/4" BSPT	£2.15	£1.89
CDHRST0801	8 mm	1/8" BSPT	£2.19	£1.92
CDHRST0802	8 mm	1/4" BSPT	£2.22	£1.95
CDHRST0803	8 mm	3/8" BSPT	£2.24	£1.96
CDHRST1003	10 mm	3/8" BSPT	£2.49	£2.19



HRPL-G
BSPP SWIVEL ELBOW



3720

PART NUMBER	TUBE	MALE THREAD	PRICE EACH	
			1 - 9	10 +
CDHRPL08G01	8 mm	1/8" BSPP	£1.89	£1.65
CDHRPL08G02	8 mm	1/4" BSPP	£1.89	£1.66
CDHRPL08G03	8 mm	3/8" BSPP	£1.93	£1.69
CDHRPL10G02	10 mm	1/4" BSPP	£2.00	£1.75
CDHRPL10G03	10 mm	3/8" BSPP	£2.06	£1.81
CDHRPL10G04	10 mm	1/2" BSPP	£2.12	£1.86
CDHRPL12G03	12 mm	3/8" BSPP	£2.18	£1.91



HRST-G
BSPP SWIVEL RUN TEE



3720

PART NUMBER	TUBE	MALE THREAD	PRICE EACH	
			1 - 9	10 +
CDHRST08G01	6 mm	1/8" BSPP	£2.23	£1.96
CDHRST08G02	8 mm	1/4" BSPP	£2.24	£1.97
CDHRST08G03	8 mm	3/8" BSPP	£2.28	£2.00
CDHRST10G02	10 mm	1/4" BSPP	£2.51	£2.20
CDHRST10G03	10 mm	3/8" BSPP	£2.57	£2.26
CDHRST10G04	10 mm	1/2" BSPP	£2.62	£2.30
CDHRST12G03	12 mm	3/8" BSPP	£2.71	£2.38



HRPT
BSPT SWIVEL TEE



3720

PART NUMBER	TUBE	MALE THREAD	PRICE EACH	
			1 - 9	10 +
CDHRPT0601	6 mm	1/8" BSPT	£2.13	£1.87
CDHRPT0602	6 mm	1/4" BSPT	£2.15	£1.89
CDHRPT0801	8 mm	1/8" BSPT	£2.19	£1.92
CDHRPT0802	8 mm	1/4" BSPT	£2.22	£1.95
CDHRPT0803	8 mm	3/8" BSPT	£2.24	£1.96
CDHRPT1003	10 mm	3/8" BSPT	£2.49	£2.19



HRWT
BSPT SWIVEL Y



3720

PART NUMBER	TUBE	MALE THREAD	PRICE EACH	
			1 - 9	10 +
CDHRWT0601	6 mm	1/8" BSPT	£2.27	£1.99
CDHRWT0602	6 mm	1/4" BSPT	£2.28	£2.00
CDHRWT0801	8 mm	1/8" BSPT	£2.35	£2.06
CDHRWT0802	8 mm	1/4" BSPT	£2.38	£2.08
CDHRWT0803	8 mm	3/8" BSPT	£2.39	£2.10
CDHRWT1003	10 mm	3/8" BSPT	£2.62	£2.29



HRPT-G
BSPP SWIVEL TEE



3720

PART NUMBER	TUBE	MALE THREAD	PRICE EACH	
			1 - 9	10 +
CDHRPT08G01	8 mm	1/8" BSPP	£2.19	£1.92
CDHRPT08G02	8 mm	1/4" BSPP	£2.24	£1.97
CDHRPT08G03	8 mm	3/8" BSPP	£2.28	£2.00
CDHRPT10G02	10 mm	1/4" BSPP	£2.51	£2.20
CDHRPT10G03	10 mm	3/8" BSPP	£2.57	£2.26
CDHRPT10G04	10 mm	1/2" BSPP	£2.62	£2.30
CDHRPT12G03	12 mm	3/8" BSPP	£2.71	£2.38



HRWT-G
BSPP SWIVEL Y



3720

PART NUMBER	TUBE	MALE THREAD	PRICE EACH	
			1 - 9	10 +
CDHRWT08G01	8 mm	1/8" BSPP	£2.39	£2.09
CDHRWT08G02	8 mm	1/4" BSPP	£2.40	£2.10
CDHRWT08G03	8 mm	3/8" BSPP	£2.43	£2.13
CDHRWT10G02	10 mm	1/4" BSPP	£2.63	£2.31
CDHRWT10G03	10 mm	3/8" BSPP	£2.69	£2.36
CDHRWT10G04	10 mm	1/2" BSPP	£2.75	£2.41
CDHRWT12G03	12 mm	3/8" BSPP	£2.82	£2.47



HCVB HOSETAIL VALVED CONNECTOR



3720

PART NUMBER	TUBE OD (A)	HOSE ID (B)	PRICE EACH	
			1 - 9	10 +
CDHCVB15-1/2	15 mm	1/2"	£4.07	£3.57
CDHCVB22-1/2	22 mm	1/2"	£4.73	£4.14
CDHCVB22-3/4	22 mm	3/4"	£5.39	£4.73



HCJB STEM STRAIGHT



3720

PART NUMBER	STEM OD (A)	HOSE ID (B)	PRICE EACH	
			1 - 9	10 +
CDHCJB0604	6 mm	4 mm	£0.70	£0.61
CDHCJB0606	6 mm	6 mm	£0.70	£0.61
CDHCJB0806	8 mm	6 mm	£0.70	£0.62
CDHCJB1006	10 mm	6 mm	£0.71	£0.62
CDHCJB1008	10 mm	8 mm	£0.71	£0.62



HCBB STRAIGHT HOSETAIL



3720

PART NUMBER	TUBE OD (A)	HOSE ID (B)	PRICE EACH	
			1 - 9	10 +
CDHCBB1210	12 mm	10 mm	£1.68	£1.48
CDHCBB15-1/2	15 mm	1/2"	£1.40	£1.24
CDHCBB22-1/2	22 mm	1/2"	£2.27	£1.99
CDHCBB22-3/4	22 mm	3/4"	£2.36	£2.08



HLJB STEM ELBOW



3720

PART NUMBER	STEM OD (A)	HOSE ID (B)	PRICE EACH	
			1 - 9	10 +
CDHLJB1006	10 mm	6 mm	£0.72	£0.63
CDHLJB1008	10 mm	8 mm	£0.73	£0.64

BRASS FITTINGS



HCAS BRASS TUBE INSERT F TYPE CARTRIDGE



3720

PART NUMBER	TUBE OD	PRICE EACH	
		1 - 9	10 +
CDHCAS-F04	4 mm	£1.36	£1.19
CDHCAS-F06	6 mm	£1.56	£1.37
CDHCAS-F08	8 mm	£1.72	£1.51
CDHCAS-F10	10 mm	£1.90	£1.66
CDHCAS-F12	12 mm	£2.16	£1.90



HCAS BRASS TUBE INSERT H TYPE CARTRIDGE



3720

PART NUMBER	TUBE OD	PRICE EACH	
		1 - 9	10 +
CDHCAS-H04	4 mm	£1.10	£0.97
CDHCAS-H06	6 mm	£1.17	£1.04
CDHCAS-H08	8 mm	£1.17	£1.02
CDHCAS-H10	10 mm	£1.35	£1.19
CDHCAS-H12	12 mm	£1.87	£1.64

METRIC FLOW REGULATORS



HSLB ELBOW



3720

PART NUMBER	TUBE OD	PRICE EACH	
		1 - 9	10 +
CDHSLB0606	6 mm	£8.94	£7.84
CDHSLB1010	10 mm	£10.71	£9.39



HCVU NON-RETURN CHECK VALVE



3720

PART NUMBER	TUBE OD	PRICE EACH	
		1 - 9	10 +
CDHCVU0404	4 mm	£8.22	£7.20
CDHCVU0606	6 mm	£8.23	£7.23
CDHCVU0808	8 mm	£8.72	£7.67
CDHCVU1010	10 mm	£9.22	£8.10
CDHCVU1212	12 mm	£9.69	£8.52



HSTB IN-LINE



3720

PART NUMBER	TUBE OD	PRICE EACH	
		1 - 9	10 +
CDHSTB0606	6 mm	£8.94	£7.84
CDHSTB1010	10 mm	£10.71	£9.39



HPC-G
STRAIGHT ADAPTOR



3720

PART NUMBER	TUBE	THREAD	PRICE EACH	
			1 - 9	10 +
CDHPC3/16-G01	3/16"	1/8"	£1.00	£0.88
CDHPC1/4-G01	1/4"	1/8"	£1.12	£0.99
CDHPC1/4-G02	1/4"	1/4"	£1.17	£1.02
CDHPC5/16-G01	5/16"	1/8"	£1.03	£0.91
CDHPC5/16-G02	5/16"	1/4"	£1.06	£0.93
CDHPC5/16-G03	5/16"	3/8"	£1.12	£0.99
CDHPC3/8-G02	3/8"	1/4"	£1.29	£1.13
CDHPC3/8-G03	3/8"	3/8"	£1.30	£1.14
CDHPC1/2-G04	1/2"	1/2"	£1.57	£1.38



HCF
STRAIGHT ADAPTOR



3720

PART NUMBER	TUBE	THREAD	PRICE EACH	
			1 - 9	10 +
CDHCF1/4-G04	1/4"	1/2"	£1.53	£1.34
CDHCF1/4-G06	1/4"	3/4"	£6.00	£5.26
CDHCF3/8-G04	3/8"	1/2"	£1.57	£1.38
CDHCF3/8-G04H	3/8"	1/2"	£2.06	£1.80
CDHCF3/8-G05	3/8"	5/8"	£2.16	£1.89
CDHCF3/8-G05H	3/8"	5/8"	£2.12	£1.86
CDHCF3/8-G06	3/8"	3/4"	£5.41	£4.75
CDHCF1/2-G04	1/2"	1/2"	£2.36	£2.07



HRPL
BSPP SWIVEL ELBOW



3720

PART NUMBER	TUBE	THREAD	PRICE EACH	
			1 - 9	10 +
CDHRPL1/4-G01	1/4"	1/8"	£1.83	£1.62
CDHRPL1/4-G02	1/4"	1/4"	£1.87	£1.65
CDHRPL3/8-G02	3/8"	1/4"	£2.05	£1.81
CDHRPL3/8-G03	3/8"	3/8"	£2.11	£1.86



HRST
BSPP SWIVEL RUN TEE



3720

PART NUMBER	TUBE	THREAD	PRICE EACH	
			1 - 9	10 +
CDHRST1/4-G01	1/4"	1/8"	£2.24	£1.98
CDHRST1/4-G02	1/4"	1/4"	£2.27	£2.01
CDHRST3/8-G02	3/8"	1/4"	£2.53	£2.24
CDHRST3/8-G03	3/8"	3/8"	£2.59	£2.29



HRPT
BSPP SWIVEL TEE



3720

PART NUMBER	TUBE	THREAD	PRICE EACH	
			1 - 9	10 +
CDHRPT1/4-G01	1/4"	1/8"	£2.24	£1.98
CDHRPT1/4-G02	1/4"	1/4"	£2.27	£2.01
CDHRPT3/8-G02	3/8"	1/4"	£2.53	£2.24
CDHRPT3/8-G03	3/8"	3/8"	£2.59	£2.29



HRWT
BSPP SWIVEL Y



3720

PART NUMBER	TUBE	THREAD	PRICE EACH	
			1 - 9	10 +
CDHRWT1/4-G01	1/4"	1/8"	£2.26	£2.00
CDHRWT1/4-G02	1/4"	1/4"	£2.29	£2.03
CDHRWT3/8-G02	3/8"	1/4"	£2.53	£2.24
CDHRWT3/8-G03	3/8"	3/8"	£2.59	£2.29



HUC
EQUAL UNION STRAIGHT



3720

PART NUMBER	TUBE OD	PRICE EACH	
		1 - 9	10 +
CDHUC5/32	5/32"	£1.17	£1.04
CDHUC3/16	3/16"	£1.17	£1.04
CDHUC1/4	1/4"	£1.14	£1.00
CDHUC5/16	5/16"	£1.28	£1.12
CDHUC3/8	3/8"	£1.65	£1.26
CDHUC1/2	1/2"	£1.76	£1.30



HUL
EQUAL ELBOW



3720

PART NUMBER	TUBE OD	PRICE EACH	
		1 - 9	10 +
CDHUL5/32	5/32"	£1.16	£1.01
CDHUL3/16	3/16"	£1.19	£1.06
CDHUL1/4	1/4"	£1.20	£1.06
CDHUL5/16	5/16"	£1.23	£1.08
CDHUL3/8	3/8"	£1.37	£1.21
CDHUL1/2	1/2"	£1.73	£1.52

REDUCING UNION STRAIGHT

PART NUMBER	TUBE OD	TUBE OD	PRICE EACH	
			1 - 9	10 +
CDHUC5/16-5/32	5/16"	5/32"	£1.33	£1.17
CDHUC5/16-1/4	5/16"	1/4"	£1.28	£1.12
CDHUC3/8-1/4	3/8"	1/4"	£1.65	£1.45
CDHUC3/8-5/16	3/8"	5/16"	£1.66	£1.46
CDHUC1/2-5/16	1/2"	5/16"	£1.73	£1.53
CDHUC1/2-3/8	1/2"	3/8"	£1.72	£1.51

REDUCING ELBOW

PART NUMBER	TUBE OD	TUBE OD	PRICE EACH	
			1 - 9	10 +
CDHUL5/16-5/32	5/16"	5/32"	£1.32	£1.16
CDHUL5/16-1/4	5/16"	1/4"	£1.36	£1.19
CDHUL3/8-5/16	3/8"	5/16"	£1.56	£1.37
CDHUL1/2-3/8	1/2"	3/8"	£1.76	£1.55

**HUT
EQUAL TEE**



3720

PART NUMBER	TUBE OD	PRICE EACH	
		1 - 9	10 +
CDHUT5/32	5/32"	£1.58	£1.39
CDHUT3/16	3/16"	£1.58	£1.39
CDHUT1/4	1/4"	£1.61	£1.33
CDHUT5/16	5/16"	£1.68	£1.39
CDHUT3/8	3/8"	£1.86	£1.64
CDHUT1/2	1/2"	£2.13	£1.88

**HPF
END CAP**



3720

PART NUMBER	TUBE OD	PRICE EACH	
		1 - 9	10 +
CDHPF1/4	1/4"	£0.95	£0.84
CDHPF5/16	5/16"	£0.99	£0.87
CDHPF3/8	3/8"	£1.12	£0.99
CDHPF1/2	1/2"	£1.23	£1.08

**HUY
EQUAL UNION Y**



3720

PART NUMBER	TUBE OD	PRICE EACH	
		1 - 9	10 +
CDHUY5/32	5/32"	£1.54	£1.35
CDHUY3/16	3/16"	£1.63	£1.43
CDHUY1/4	1/4"	£1.63	£1.43
CDHUY5/16	5/16"	£1.74	£1.53
CDHUY3/8	3/8"	£1.93	£1.70
CDHUY1/2	1/2"	£2.13	£1.88

**HBU
U BEND**



3720

PART NUMBER	TUBE OD	PRICE EACH	
		1 - 9	10 +
CDHBU1/2-1/2	1/2"	£2.08	£1.82

**HMM
BULKHEAD**



3720

PART NUMBER	TUBE OD	TUBE OD	PRICE EACH	
			1 - 9	10 +
CDHMM5/32	5/32"	5/32"	£1.51	£1.33
CDHMM1/4	1/4"	1/4"	£1.56	£1.37
CDHMM5/16	5/16"	5/16"	£1.76	£1.55
CDHMM3/8	3/8"	3/8"	£1.89	£1.65
CDHMM1/2	1/2"	1/2"	£2.31	£2.03

REDUCING BULKHEAD

PART NUMBER	TUBE OD	TUBE OD	PRICE EACH
CDHMM1/4-3/8	1/4"	3/8"	£2.04 £1.80

**HGG
STEM REDUCER**



3720

PART NUMBER	STEM OD (A)	TUBE OD (B)	PRICE EACH	
			1 - 9	10 +
CDHGJ1/4-5/32	1/4"	5/32"	£0.96	£0.84
CDHGJ5/16-1/4	5/16"	1/4"	£0.95	£0.83
CDHGJ3/8-1/4	3/8"	1/4"	£1.08	£0.96
CDHGJ3/8-5/16	3/8"	5/16"	£1.07	£0.93
CDHGJ1/2-3/8	1/2"	3/8"	£1.67	£1.02

**HPP
PLUG**



3720

PART NUMBER	TUBE OD	PRICE EACH	
		1 - 9	10 +
CDHPP5/32	5/32"	£0.42	£0.37
CDHPP3/16	3/16"	£0.42	£0.37
CDHPP1/4	1/4"	£0.45	£0.40
CDHPP5/16	5/16"	£0.43	£0.38
CDHPP3/8	3/8"	£0.48	£0.42
CDHPP1/2	1/2"	£0.65	£0.57

**HLJ
STEM ELBOW**



3720

PART NUMBER	TUBE OD (A)	STEM OD (B)	PRICE EACH	
			1 - 9	10 +
CDHLJ5/32	5/32"	5/32"	£1.00	£0.88
CDHLJ3/16	3/16"	3/16"	£1.02	£0.90
CDHLJ1/4	1/4"	1/4"	£1.02	£0.90
CDHLJ5/16	5/16"	5/16"	£1.12	£0.99
CDHLJ3/8	3/8"	3/8"	£1.17	£1.02
CDHLJ1/2	1/2"	1/2"	£1.54	£1.35

REDUCING STEM ELBOW

PART NUMBER	TUBE OD	TUBE OD	PRICE EACH
CDHLJ3/8-1/4	3/8"	1/4"	£1.12 £0.99
CDHLJ3/8-5/16	3/8"	5/16"	£1.29 £1.14

**HCP
CLIP**



3720

PART NUMBER	TUBE OD	PRICE EACH	
		1 - 9	10 +
CDHCP5/32	5/32"	£0.09	£0.08
CDHCP3/16	3/16"	£0.09	£0.08
CDHCP1/4	1/4"	£0.09	£0.08
CDHCP5/16	5/16"	£0.09	£0.08
CDHCP3/8	3/8"	£0.09	£0.08
CDHCP1/2	1/2"	£0.09	£0.08



HLJB
STEM ELBOW

3720

PART NUMBER	STEM OD (A)	HOSE OD (B)	PRICE EACH	
			1 - 9	10 +
CDHLJB3/8-5/16	5/16"	3/8"	£0.73	£0.64
CDHLJB3/8-3/8	3/8"	3/8"	£0.74	£0.65



HCJB
STEM STRAIGHT

3720

PART NUMBER	STEM OD (A)	HOSE OD (B)	PRICE EACH	
			1 - 9	10 +
CDHCJB1/4-1/4	1/4"	1/4"	£0.69	£0.60
CDHCJB5/16-5/16	5/16"	5/16"	£0.70	£0.62
CDHCJB3/8-3/8	3/8"	3/8"	£0.71	£0.62
CDHCJB3/8-5/16	5/16"	3/8"	£0.71	£0.62
CDHCJB1/2-3/8	3/8"	1/2"	£0.73	£0.64

IMPERIAL FLOW REGULATORS



HSLB
ELBOW FLOW REGULATOR

3720

PART NUMBER	TUBE OD	PRICE EACH	
		1 - 9	10 +
CDHSLB1/4-1/4	1/4"	£8.94	£7.84
CDHSLB3/8-3/8	3/8"	£10.71	£9.39



HSTB
IN-LINE FLOW REGULATOR

3720

PART NUMBER	TUBE OD	PRICE EACH	
		1 - 9	10 +
CDHSTB1/4-1/4	1/4"	£8.94	£7.84
CDHSTB3/8-3/8	3/8"	£10.71	£9.39

IMPERIAL THREAD TO THREAD

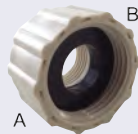

HUFF
THREADED FEMALE REDUCER

3720

PART NUMBER	TUBE OD (A)	THREAD (B)	PRICE EACH	
			1 - 9	10 +
CDHUFF-G02-G06	1/4"	3/4"	£1.78	£1.56
CDHUFF-G03-G06	3/8"	3/4"	£2.24	£1.97

IMPERIAL CHECK VALVES



HCVU
NON-RETURN CHECK VALVE

3720

PART NUMBER	TUBE OD	PRICE EACH	
		1 - 9	10 +
CDHCVU1/4	1/4"	£8.23	£7.23
CDHCVU5/16	5/16"	£8.72	£7.67
CDHCVU3/8	3/8"	£9.22	£8.10
CDHCVU1/2	1/2"	£9.69	£8.52

NEW ONE TOUCH 20 BAR FITTINGS

- Smaller fittings, featuring wider working pressure and temperature ranges
- One touch, push-to-connect configuration allows instant tubing connection
- Main body of PL and PT types is a rotating structure for efficient piping
- The section has an O-ring or Teflon coating
- One touch type pipe connection tool for air pressure piping
- Various uses depending on the user's environment

SPECIFICATIONS

Fluid type	Air (No other type of gas or liquid)
Working pressure	0 to 290 psi (20 bar)
Negative pressure	-29.5 in Hg / -750 mm Hg (-750 Torr)
Working temperature	-20°C to +80°C (-4°F to +176°F)
Application tube	Polyurethane and nylon

CLASSIC ONE TOUCH FITTINGS

- One touch, push-to-connect configuration allows instant tubing connection
- PC type has internal / external hexagonal shapes for efficient piping in limited spaces
- Main body of PL and PT types is a rotating structure for efficient piping
- The section has an O-ring or Teflon coating
- One touch type pipe connection tool for air pressure piping
- Various uses depending on the user's environment

SPECIFICATIONS

Fluid type	Air (No other type of gas or liquid)
Working pressure	0 to 150 psi (10.2 bar)
Negative pressure	-29.5 in Hg / -750 mm Hg (-750 Torr)
Working temperature	0°C to +60°C (+32°F to +140°F)
Application tube	Polyurethane and nylon

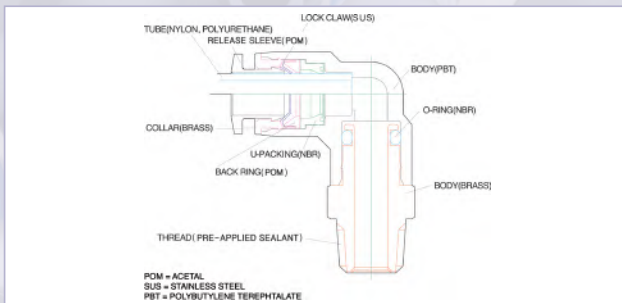

COMPACT ONE TOUCH FITTINGS

- One touch, push-to-connect configuration allows instant tubing connection
- Volume and OD are smaller than regular type, but same flux is obtained
- Electroless nickel coated surfaces for excellent tolerance to corrosion
- Oval sleeve is designed to allow easy release in limited spaces
- The screw section has an O-ring and Teflon coating
- Miniaturised fittings for small devices and piping in limited spaces
- Mini one touch type pipe connection tool for air pressure piping in limited spaces
- Various uses depending on the user's environment

SPECIFICATIONS

Fluid type	Air (No other type of gas or liquid)
Working pressure	0 to 150 psi (10.2 bar)
Negative pressure	-29.5 in Hg / -750 mm Hg (-750 Torr)
Working temperature	0°C to +60°C (+32°F to +140°F)
Application tube	Polyurethane and nylon

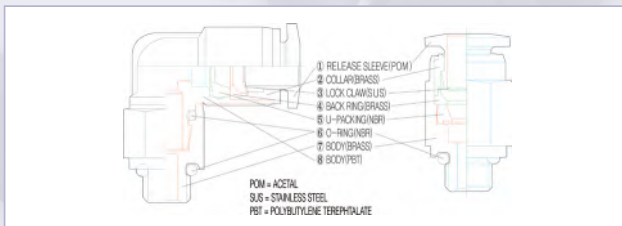

ONE TOUCH 20 BAR HIGH PRESSURE - WHITE

FEATURES

- Smaller fittings, featuring wider working pressure and temperature ranges
- One touch, push-to-connect configuration allows instant tubing connection
- Main body of PL and PT types is a rotating structure for efficient piping
- The section has an O-ring or Teflon coating

APPLICATIONS

- One touch type pipe connection tool for air pressure piping
- Various uses depending on the user's environment

SPECIFICATIONS

Fluid type	Air (No other type of gas or liquid)
Working pressure	0 to 290 psi (20 bar)
Negative pressure	-29.5 in Hg / -750 mm Hg (-750 Torr)
Working temperature	-20°C to +80°C (-4°F to +176°F)
Application tube	Polyurethane and nylon

New



MPC
STRAIGHT MALE

3700

PART NUMBER	TUBE OD	THREAD	PRICE EACH	
			1 - 9	10 +
CDMPC04M5NW	4 mm	M5 x 0.8	£2.14	£1.92
CDMPC04M6NW	4 mm	M6 x 0.8	£2.14	£1.92
CDMPC0401NW	4 mm	1/8" BSPT	£1.62	£1.46
CDMPC0402NW	4 mm	1/4" BSPT	£1.64	£1.48
CDMPC0403NW	4 mm	3/8" BSPT	£2.25	£2.03
CDMPC06M5NW	6 mm	M5 x 0.8	£2.33	£2.10
CDMPC06M6NW	6 mm	M6 x 0.8	£2.34	£2.11
CDMPC0601NW	6 mm	1/8" BSPT	£1.75	£1.57
CDMPC0602NW	6 mm	1/4" BSPT	£1.85	£1.66
CDMPC0603NW	6 mm	3/8" BSPT	£2.31	£2.08
CDMPC0604NW	6 mm	1/2" BSPT	£3.01	£2.71
CDMPC0801NW	8 mm	1/8" BSPT	£2.10	£1.89
CDMPC0802NW	8 mm	1/4" BSPT	£2.14	£1.92
CDMPC0803NW	8 mm	3/8" BSPT	£2.38	£2.14
CDMPC0804NW	8 mm	1/2" BSPT	£3.53	£3.17
CDMPC1001NW	10 mm	1/8" BSPT	£2.56	£2.30
CDMPC1002NW	10 mm	1/4" BSPT	£2.51	£2.25
CDMPC1003NW	10 mm	3/8" BSPT	£2.52	£2.27
CDMPC1004NW	10 mm	1/2" BSPT	£3.14	£2.82
CDMPC1201NW	12 mm	1/8" BSPT	£2.81	£2.53
CDMPC1202NW	12 mm	1/4" BSPT	£3.15	£2.84
CDMPC1203NW	12 mm	3/8" BSPT	£3.26	£2.93
CDMPC1204NW	12 mm	1/2" BSPT	£3.66	£3.29

New



MPC
STRAIGHT MALE WITH O-RING

3700

PART NUMBER	TUBE OD	THREAD	PRICE EACH	
			1 - 9	10 +
CDMPC04G01W	4 mm	1/8" BSPP	£1.62	£1.46
CDMPC04G02W	4 mm	1/4" BSPP	£1.64	£1.48
CDMPC04G03W	4 mm	3/8" BSPP	£2.25	£2.03
CDMPC06G01W	6 mm	1/8" BSPP	£1.75	£1.57
CDMPC06G02W	6 mm	1/4" BSPP	£1.85	£1.66
CDMPC06G03W	6 mm	3/8" BSPP	£2.31	£2.08
CDMPC06G04W	6 mm	1/2" BSPP	£3.01	£2.71
CDMPC08G01W	8 mm	1/8" BSPP	£2.10	£1.89
CDMPC08G02W	8 mm	1/4" BSPP	£2.14	£1.92
CDMPC08G03W	8 mm	3/8" BSPP	£2.38	£2.14
CDMPC08G04W	8 mm	1/2" BSPP	£3.53	£3.17
CDMPC10G01W	10 mm	1/8" BSPP	£2.56	£2.30
CDMPC10G02W	10 mm	1/4" BSPP	£2.51	£2.25
CDMPC10G03W	10 mm	3/8" BSPP	£2.52	£2.27
CDMPC10G04W	10 mm	1/2" BSPP	£3.14	£2.82
CDMPC12G02W	12 mm	1/4" BSPP	£3.15	£2.84
CDMPC12G03W	12 mm	3/8" BSPP	£3.26	£2.93
CDMPC12G04W	12 mm	1/2" BSPP	£3.66	£3.29

Eleven

New Additions



MPL
SWIVEL MALE ELBOW

3700

PART NUMBER	TUBE OD	THREAD	PRICE EACH	
			1 - 9	10 +
CDMPL04M5NW	4 mm	M5 x 0.8	£2.56	£2.30
CDMPL04M6NW	4 mm	M6 x 1.0	£2.56	£2.30
CDMPL0401NW	4 mm	1/8" BSPT	£2.16	£1.94
CDMPL0402NW	4 mm	1/4" BSPT	£2.31	£2.08
CDMPL0403NW	4 mm	3/8" BSPT	£2.81	£2.53
CDMPL06M5NW	6 mm	M5 x 0.8	£2.60	£2.34
CDMPL06M6NW	6 mm	M6 x 1.0	£2.60	£2.34
CDMPL0601NW	6 mm	1/8" BSPT	£2.21	£1.98
CDMPL0602NW	6 mm	1/4" BSPT	£2.36	£2.13
CDMPL0603NW	6 mm	3/8" BSPT	£2.78	£2.50
CDMPL0604NW	6 mm	1/2" BSPT	£3.62	£3.25
CDMPL0801NW	8 mm	1/8" BSPT	£2.61	£2.35
CDMPL0802NW	8 mm	1/4" BSPT	£2.75	£2.48
CDMPL0803NW	8 mm	3/8" BSPT	£2.82	£2.54
CDMPL0804NW	8 mm	1/2" BSPT	£4.18	£3.76
CDMPL1001NW	10 mm	1/8" BSPT	£3.53	£3.17
CDMPL1002NW	10 mm	1/4" BSPT	£3.57	£3.21
CDMPL1003NW	10 mm	3/8" BSPT	£3.58	£3.22
CDMPL1004NW	10 mm	1/2" BSPT	£4.29	£3.86
CDMPL1201NW	12 mm	1/8" BSPT	£4.13	£3.71
CDMPL1202NW	12 mm	1/4" BSPT	£4.30	£3.87
CDMPL1203NW	12 mm	3/8" BSPT	£4.44	£4.00
CDMPL1204NW	12 mm	1/2" BSPT	£4.67	£4.21

New



MPL
SWIVEL MALE ELBOW WITH O-RING

3700

PART NUMBER	TUBE OD	THREAD	PRICE EACH	
			1 - 9	10 +
CDMPL04G01W	4 mm	1/8" BSPP	£2.16	£1.94
CDMPL04G02W	4 mm	1/4" BSPP	£2.31	£2.08
CDMPL04G03W	4 mm	3/8" BSPP	£2.81	£2.53
CDMPL04G04W	4 mm	1/2" BSPP	£3.23	£2.91
CDMPL06G01W	6 mm	1/8" BSPP	£2.21	£1.98
CDMPL06G02W	6 mm	1/4" BSPP	£2.36	£2.13
CDMPL06G03W	6 mm	3/8" BSPP	£2.78	£2.50
CDMPL06G04W	6 mm	1/2" BSPP	£3.62	£3.25
CDMPL08G01W	8 mm	1/8" BSPP	£2.61	£2.35
CDMPL08G02W	8 mm	1/4" BSPP	£2.75	£2.48
CDMPL08G03W	8 mm	3/8" BSPP	£2.82	£2.54
CDMPL08G04W	8 mm	1/2" BSPP	£4.18	£3.76
CDMPL10G01W	10 mm	1/8" BSPP	£3.57	£3.21
CDMPL10G02W	10 mm	1/4" BSPP	£3.53	£3.17
CDMPL10G03W	10 mm	3/8" BSPP	£3.58	£3.22
CDMPL10G04W	10 mm	1/2" BSPP	£4.29	£3.86
CDMPL12G01W	12 mm	1/8" BSPP	£4.25	£3.83
CDMPL12G02W	12 mm	1/4" BSPP	£4.30	£3.87
CDMPL12G03W	12 mm	3/8" BSPP	£4.44	£4.00
CDMPL12G04W	12 mm	1/2" BSPP	£4.67	£4.21

ONE TOUCH 20 BAR HIGH PRESSURE - WHITE

New Additions

MPT SWIVEL BRANCH TEE



3700

PART NUMBER	TUBE OD	THREAD	PRICE EACH	
			1 - 9	10 +
CDMPT04M5NW	4 mm	M5 x 0.8	£3.40	£3.06
CDMPT04M6NW	4 mm	M6 x 1.0	£3.39	£3.05
CDMPT0401NW	4 mm	1/8" BSPT	£3.02	£2.72
CDMPT0402NW	4 mm	1/4" BSPT	£3.17	£2.85
CDMPT0403NW	4 mm	3/8" BSPT	£3.94	£3.54
CDMPT06M5NW	6 mm	M5 x 0.8	£3.74	£3.37
CDMPT06M6NW	6 mm	M6 x 1.0	£3.75	£3.38
CDMPT0601NW	6 mm	1/8" BSPT	£3.26	£2.94
CDMPT0602NW	6 mm	1/4" BSPT	£3.43	£3.08
CDMPT0603NW	6 mm	3/8" BSPT	£4.00	£3.60
CDMPT0604NW	6 mm	1/2" BSPT	£4.90	£4.41
CDMPT0801NW	8 mm	1/8" BSPT	£3.77	£3.40
CDMPT0802NW	8 mm	1/4" BSPT	£3.86	£3.48
CDMPT0803NW	8 mm	3/8" BSPT	£4.06	£3.65
CDMPT0804NW	8 mm	1/2" BSPT	£5.35	£4.81
CDMPT1001NW	10 mm	1/8" BSPT	£4.66	£4.19
CDMPT1002NW	10 mm	1/4" BSPT	£4.75	£4.27
CDMPT1003NW	10 mm	3/8" BSPT	£5.00	£4.50
CDMPT1004NW	10 mm	1/2" BSPT	£5.51	£4.96
CDMPT1201NW	12 mm	1/8" BSPT	£5.30	£4.77
CDMPT1202NW	12 mm	1/4" BSPT	£5.48	£4.93
CDMPT1203NW	12 mm	3/8" BSPT	£5.62	£5.06
CDMPT1204NW	12 mm	1/2" BSPT	£5.87	£5.28

New

MPT SWIVEL BRANCH TEE WITH O-RING



3700

PART NUMBER	TUBE OD	THREAD	PRICE EACH	
			1 - 9	10 +
CDMPT04G01W	4 mm	1/8" BSPP	£3.02	£2.72
CDMPT04G02W	4 mm	1/4" BSPP	£3.17	£2.85
CDMPT04G03W	4 mm	3/8" BSPP	£3.94	£3.54
CDMPT04G04W	4 mm	1/2" BSPP	£4.53	£4.08
CDMPT06G01W	6 mm	1/8" BSPP	£3.26	£2.94
CDMPT06G02W	6 mm	1/4" BSPP	£3.43	£3.08
CDMPT06G03W	6 mm	3/8" BSPP	£4.00	£3.60
CDMPT06G04W	6 mm	1/2" BSPP	£4.90	£4.41
CDMPT08G01W	8 mm	1/8" BSPP	£3.77	£3.40
CDMPT08G02W	8 mm	1/4" BSPP	£3.86	£3.48
CDMPT08G03W	8 mm	3/8" BSPP	£4.06	£3.65
CDMPT08G04W	8 mm	1/2" BSPP	£5.35	£4.81
CDMPT10G01W	10 mm	1/8" BSPP	£4.66	£4.19
CDMPT10G02W	10 mm	1/4" BSPP	£4.75	£4.27
CDMPT10G03W	10 mm	3/8" BSPP	£5.00	£4.50
CDMPT10G04W	10 mm	1/2" BSPP	£5.51	£4.96
CDMPT12G01W	12 mm	1/8" BSPP	£5.43	£4.89
CDMPT12G02W	12 mm	1/4" BSPP	£5.48	£4.93
CDMPT12G03W	12 mm	3/8" BSPP	£5.62	£5.06
CDMPT12G04W	12 mm	1/2" BSPP	£5.87	£5.28

MPUC STRAIGHT UNION



3700

PART NUMBER	TUBE OD	TUBE OD	PRICE EACH	
			1 - 9	10 +
CDMPUC04W	4 mm	4 mm	£1.86	£1.67
CDMPUC06W	6 mm	6 mm	£2.05	£1.84
CDMPUC08W	8 mm	8 mm	£2.15	£1.93
CDMPUC10W	10 mm	10 mm	£2.42	£2.17
CDMPUC12W	12 mm	12 mm	£3.26	£2.93

MPUL UNION ELBOW



3700

PART NUMBER	TUBE OD	TUBE OD	PRICE EACH	
			1 - 9	10 +
CDMPUL04W	4 mm	4 mm	£1.76	£1.58
CDMPUL06W	6 mm	6 mm	£2.05	£1.84
CDMPUL08W	8 mm	8 mm	£2.15	£1.93
CDMPUL10W	10 mm	10 mm	£2.42	£2.17
CDMPUL12W	12 mm	12 mm	£3.26	£2.93

New

MPG REDUCER



3700

PART NUMBER	TUBE OD	TUBE OD	PRICE EACH	
			1 - 9	10 +
CDMPG0604W	6 mm	4 mm	£2.08	£1.87
CDMPG0804W	8 mm	4 mm	£2.27	£2.04
CDMPG0806W	8 mm	6 mm	£2.27	£2.05
CDMPG1006W	10 mm	6 mm	£3.00	£2.70
CDMPG1008W	10 mm	8 mm	£3.00	£2.70
CDMPG1208W	12 mm	8 mm	£3.14	£2.82
CDMPG1210W	12 mm	10 mm	£3.14	£2.82

MPUT UNION TEE



3700

PART NUMBER	TUBE OD	TUBE OD	PRICE EACH	
			1 - 9	10 +
CDMPUT04W	4 mm	4 mm	£3.17	£2.85
CDMPUT06W	6 mm	6 mm	£3.17	£2.85
CDMPUT08W	8 mm	8 mm	£3.26	£2.93
CDMPUT10W	10 mm	10 mm	£3.44	£3.10
CDMPUT12W	12 mm	12 mm	£4.84	£4.35

New

MEVU QUICK EXHAUST VALVE



3700

PART NUMBER	TUBE OD	TUBE OD	PRICE EACH	
			1 - 9	10 +
CDMEVU0404W	4 mm	4 mm	£11.07	£9.96
CDMEVU0606W	6 mm	6 mm	£11.66	£10.49

New

MPY UNION Y



3700

PART NUMBER	TUBE OD	TUBE OD	PRICE EACH	
			1 - 9	10 +
CDMPY04W	4 mm	4 mm	£3.88	£3.49
CDMPY06W	6 mm	6 mm	£3.88	£3.49
CDMPY08W	8 mm	8 mm	£3.88	£3.49
CDMPY10W	10 mm	10 mm	£4.31	£3.87
CDMPY12W	12 mm	12 mm	£5.36	£4.82

FEATURES

- One touch, push-to-connect configuration allows instant tubing connection
- PC type has internal / external hexagonal shapes for efficient piping in limited spaces
- Main body of PL and PT types is a rotating structure for efficient piping
- The section has an O-ring or Teflon coating

APPLICATIONS

- One touch type pipe connection tool for air pressure piping
- Various uses depending on the user's environment

SPECIFICATIONS

Fluid type	Air (No other type of gas or liquid)
Working pressure	0 to 150 psi (10.2 bar)
Negative pressure	-29.5 in Hg / -750 mm Hg (-750 Torr)
Working temperature	0°C to +60°C (+32°F to +140°F)
Application tube	Polyurethane and nylon

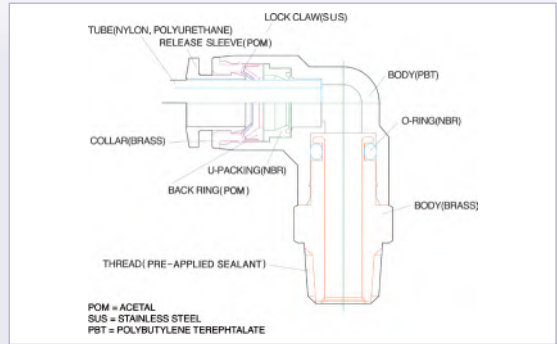

TUBE TO THREAD



**PC
MALE STRAIGHT**

3700

PART NUMBER	TUBE OD	THREAD	PRICE EACH	
			1 - 9	10 +
CDPC04M5N	4 mm	M5 x 0.8	£2.00	£1.80
CDPC04M6N	4 mm	M6 x 1.0	£2.00	£1.80
CDPC0401N	4 mm	1/8" BSPT	£1.62	£1.46
CDPC0402N	4 mm	1/4" BSPT	£1.53	£1.37
CDPC0403N	4 mm	3/8" BSPT	£2.10	£1.89
CDPC06M5N	6 mm	M5 x 0.8	£2.18	£1.96
CDPC06M6N	6 mm	M6 x 1.0	£2.18	£1.96
CDPC0601N	6 mm	1/8" BSPT	£1.63	£1.47
CDPC0602N	6 mm	1/4" BSPT	£1.72	£1.55
CDPC0603N	6 mm	3/8" BSPT	£2.15	£1.93
CDPC0604N	6 mm	1/2" BSPT	£2.81	£2.53
CDPC0801N	8 mm	1/8" BSPT	£1.95	£1.76
CDPC0802N	8 mm	1/4" BSPT	£2.00	£1.80
CDPC0803N	8 mm	3/8" BSPT	£2.21	£1.99
CDPC0804N	8 mm	1/2" BSPT	£3.28	£2.95
CDPC1001N	10 mm	1/8" BSPT	£2.39	£2.15
CDPC1002N	10 mm	1/4" BSPT	£2.34	£2.10
CDPC1003N	10 mm	3/8" BSPT	£2.35	£2.11
CDPC1004N	10 mm	1/2" BSPT	£2.93	£2.63
CDPC1201N	12 mm	1/8" BSPT	£2.63	£2.36
CDPC1202N	12 mm	1/4" BSPT	£2.94	£2.65
CDPC1203N	12 mm	3/8" BSPT	£3.03	£2.73
CDPC1204N	12 mm	1/2" BSPT	£3.42	£3.07
CDPC1403N	14 mm	3/8" BSPT	£5.71	£5.13
CDPC1404N	14 mm	1/2" BSPT	£5.76	£5.18
CDPC1603N	16 mm	3/8" BSPT	£9.04	£8.14
CDPC1604N	16 mm	1/2" BSPT	£9.07	£8.16



**PC-G
MALE STRAIGHT**

3700

PART NUMBER	TUBE OD	THREAD	PRICE EACH	
			1 - 9	10 +
CDPC04G01	4 mm	1/8" BSPP	£1.51	£1.36
CDPC04G02	4 mm	1/4" BSPP	£1.53	£1.37
CDPC04G03	4 mm	3/8" BSPP	£2.10	£1.89
CDPC06G01	6 mm	1/8" BSPP	£1.63	£1.47
CDPC06G02	6 mm	1/4" BSPP	£1.72	£1.55
CDPC06G03	6 mm	3/8" BSPP	£2.15	£1.93
CDPC08G01	8 mm	1/8" BSPP	£1.95	£1.76
CDPC08G02	8 mm	1/4" BSPP	£2.00	£1.80
CDPC08G03	8 mm	3/8" BSPP	£2.21	£1.99
CDPC08G04	8 mm	1/2" BSPP	£3.28	£2.95
CDPC10G01	10 mm	1/8" BSPP	£2.39	£2.15
CDPC10G02	10 mm	1/4" BSPP	£2.34	£2.10
CDPC10G03	10 mm	3/8" BSPP	£2.35	£2.11
CDPC10G04	10 mm	1/2" BSPP	£2.93	£2.63
CDPC12G02	12 mm	1/4" BSPP	£2.94	£2.65
CDPC12G03	12 mm	3/8" BSPP	£3.03	£2.73
CDPC12G04	12 mm	1/2" BSPP	£3.42	£3.07
CDPC14G03	14 mm	3/8" BSPP	£5.71	£5.13
CDPC14G04	14 mm	1/2" BSPP	£5.76	£5.18
CDPC16G03	16 mm	3/8" BSPP	£9.04	£8.14
CDPC16G04	16 mm	1/2" BSPP	£9.07	£8.16

For Nylon Tube,
see pages 508-510.



TUBE TO THREAD



POC
MALE STRAIGHT ROUND

3700

PART NUMBER	TUBE OD	THREAD	PRICE EACH	
			1 - 9	10 +
CDPOC04M5N	4 mm	M5 x 0.8	£2.14	£1.93
CDPOC04M6N	4 mm	M6 x 1.0	£2.38	£2.14
CDPOC0401N	4 mm	1/8" BSPT	£1.81	£1.63
CDPOC0402N	4 mm	1/4" BSPT	£1.83	£1.64
CDPOC0403N	4 mm	3/8" BSPT	£2.35	£2.12
CDPOC06M5N	6 mm	M5 x 0.8	£2.60	£2.34
CDPOC06M6N	6 mm	M6 x 1.0	£2.60	£2.34
CDPOC0601N	6 mm	1/8" BSPT	£1.95	£1.76
CDPOC0602N	6 mm	1/4" BSPT	£2.05	£1.85
CDPOC0603N	6 mm	3/8" BSPT	£2.58	£2.32
CDPOC0801N	8 mm	1/8" BSPT	£2.34	£2.10
CDPOC0802N	8 mm	1/4" BSPT	£2.38	£2.14
CDPOC0803N	8 mm	3/8" BSPT	£2.65	£2.39
CDPOC0804N	8 mm	1/2" BSPT	£3.93	£3.54
CDPOC1001N	10 mm	1/8" BSPT	£2.86	£2.57
CDPOC1002N	10 mm	1/4" BSPT	£2.79	£2.51
CDPOC1003N	10 mm	3/8" BSPT	£2.81	£2.53
CDPOC1004N	10 mm	1/2" BSPT	£3.51	£3.16
CDPOC1201N	12 mm	1/8" BSPT	£3.69	£3.32
CDPOC1202N	12 mm	1/4" BSPT	£3.52	£3.17
CDPOC1203N	12 mm	3/8" BSPT	£3.63	£3.27
CDPOC1204N	12 mm	1/2" BSPT	£4.09	£3.68



PCF
FEMALE STRAIGHT

3700

PART NUMBER	TUBE OD	THREAD	PRICE EACH	
			1 - 9	10 +
CDPCF0401N	4 mm	1/8" BSPT	£2.25	£2.02
CDPCF0402N	4 mm	1/4" BSPT	£2.38	£2.14
CDPCF0403N	4 mm	3/8" BSPT	£2.88	£2.60
CDPCF0601N	6 mm	1/8" BSPT	£2.42	£2.18
CDPCF0602N	6 mm	1/4" BSPT	£2.62	£2.36
CDPCF0603N	6 mm	3/8" BSPT	£2.98	£2.68
CDPCF0801N	8 mm	1/8" BSPT	£3.14	£2.83
CDPCF0802N	8 mm	1/4" BSPT	£4.14	£3.72
CDPCF0803N	8 mm	3/8" BSPT	£4.15	£3.74
CDPCF0804N	8 mm	1/2" BSPT	£4.61	£4.15
CDPCF1001N	10 mm	1/8" BSPT	£3.47	£3.12
CDPCF1002N	10 mm	1/4" BSPT	£3.47	£3.12
CDPCF1003N	10 mm	3/8" BSPT	£4.38	£3.94
CDPCF1004N	10 mm	1/2" BSPT	£4.73	£4.26
CDPCF1202N	12 mm	1/4" BSPT	£4.68	£4.21
CDPCF1203N	12 mm	3/8" BSPT	£4.83	£4.35
CDPCF1204N	12 mm	1/2" BSPT	£5.69	£5.12



PCF-G
FEMALE STRAIGHT

3700

PART NUMBER	TUBE OD	THREAD	PRICE EACH	
			1 - 9	10 +
CDPCF04G01	4 mm	1/8" BSPP	£2.25	£2.02
CDPCF04G02	4 mm	1/4" BSPP	£2.38	£2.14
CDPCF04G03	4 mm	3/8" BSPP	£2.88	£2.60
CDPCF06G01	6 mm	1/8" BSPP	£2.42	£2.18
CDPCF06G02	6 mm	1/4" BSPP	£2.62	£2.36
CDPCF06G03	6 mm	3/8" BSPP	£2.98	£2.68
CDPCF08G01	8 mm	1/8" BSPP	£3.14	£2.83
CDPCF08G02	8 mm	1/4" BSPP	£4.14	£3.72
CDPCF08G03	8 mm	3/8" BSPP	£4.15	£3.74
CDPCF08G04	8 mm	1/2" BSPP	£4.61	£4.15
CDPCF10G01	10 mm	1/8" BSPP	£3.47	£3.12
CDPCF10G02	10 mm	1/4" BSPP	£3.47	£3.12
CDPCF10G03	10 mm	3/8" BSPP	£4.38	£3.94
CDPCF10G04	10 mm	1/2" BSPP	£4.73	£4.26
CDPCF12G02	12 mm	1/4" BSPP	£4.68	£4.21
CDPCF12G03	12 mm	3/8" BSPP	£4.83	£4.35
CDPCF12G04	12 mm	1/2" BSPP	£5.69	£5.12

For CEJN Quick Connect
Pneumatic Couplings,
see pages 6-16 & 21-25.

METRIC TUBE TO TUBE

PUC
EQUAL STRAIGHT UNION



3700

PART NUMBER	TUBE OD	PRICE EACH	
		1 - 9	10 +
CDPUC04N	4 mm	£1.74	£1.56
CDPUC06N	6 mm	£1.92	£1.73
CDPUC08N	8 mm	£2.00	£1.80
CDPUC10N	10 mm	£2.26	£2.03
CDPUC12N	12 mm	£3.05	£2.74
CDPUC14N	14 mm	£3.39	£3.05
CDPUC16N	16 mm	£6.94	£6.24

PY
EQUAL UNION 'Y'



3700

PART NUMBER	TUBE OD	PRICE EACH	
		1 - 9	10 +
CDPY04N	4 mm	£3.62	£3.26
CDPY06N	6 mm	£3.62	£3.26
CDPY08N	8 mm	£3.62	£3.26
CDPY10N	10 mm	£4.02	£3.62
CDPY12N	12 mm	£5.00	£4.50
CDPY16N	16 mm	£10.51	£9.46

PUT
EQUAL UNION TEE



3700

PART NUMBER	TUBE OD	PRICE EACH	
		1 - 9	10 +
CDPUT04N	4 mm	£2.95	£2.66
CDPUT06N	6 mm	£2.95	£2.66
CDPUT08N	8 mm	£3.05	£2.74
CDPUT10N	10 mm	£3.21	£2.89
CDPUT12N	12 mm	£4.52	£4.06
CDPUT14N	14 mm	£5.20	£4.68
CDPUT16N	16 mm	£10.51	£9.46

PW
REDUCER 'Y'



3700

PART NUMBER	TUBE OD (A)	TUBE OD (B)	PRICE EACH	
			1 - 9	10 +
CDPW0604	6 mm	4 mm	£2.77	£2.49
CDPW0804	8 mm	4 mm	£2.91	£2.61
CDPW0806	8 mm	6 mm	£2.90	£2.61
CDPW1006	10 mm	6 mm	£3.35	£3.02
CDPW1008	10 mm	8 mm	£3.35	£3.02
CDPW1208	12 mm	8 mm	£4.47	£4.02
CDPW1210	12 mm	10 mm	£4.47	£4.03
CDPW1612	16 mm	12 mm	£11.56	£10.41

PUL
EQUAL UNION ELBOW

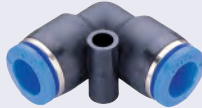

3700

PART NUMBER	TUBE OD	PRICE EACH	
		1 - 9	10 +
CDPUL04N	4 mm	£1.64	£1.47
CDPUL06N	6 mm	£1.92	£1.73
CDPUL08N	8 mm	£2.00	£1.80
CDPUL10N	10 mm	£2.26	£2.03
CDPUL12N	12 mm	£3.05	£2.74
CDPUL14N	14 mm	£3.45	£3.11
CDPUL16N	16 mm	£6.99	£6.29

PZA
UNION CROSS



3700

PART NUMBER	TUBE OD	TUBE OD	PRICE EACH	
			1 - 9	10 +
CDPZA04N	4 mm	4 mm	£4.31	£3.87
CDPZA06N	6 mm	6 mm	£4.80	£4.32
CDPZA08N	8 mm	8 mm	£4.92	£4.43
CDPZA10N	10 mm	10 mm	£5.65	£5.08
CDPZA12N	12 mm	12 mm	£5.99	£5.39

PGT
REDUCER TEE



3700

PART NUMBER	TUBE OD (A)	TUBE OD (B)	PRICE EACH	
			1 - 9	10 +
CDPGT0406N	4 mm	6 mm	£2.95	£2.66
CDPGT0604N	6 mm	4 mm	£2.95	£2.66
CDPGT0608N	6 mm	8 mm	£3.04	£2.73
CDPGT0806N	8 mm	6 mm	£3.05	£2.74
CDPGT0810N	8 mm	10 mm	£3.21	£2.89
CDPGT1006N	10 mm	6 mm	£3.16	£2.85
CDPGT1008N	10 mm	8 mm	£3.21	£2.89
CDPGT1012N	10 mm	12 mm	£4.52	£4.06
CDPGT1208N	12 mm	8 mm	£4.52	£4.06
CDPGT1210N	12 mm	10 mm	£4.52	£4.06
CDPGT1610N	16 mm	10 mm	£10.47	£9.42
CDPGT1612N	16 mm	12 mm	£10.51	£9.46

PG
REDUCER



3700

PART NUMBER	TUBE OD	TUBE OD	PRICE EACH	
			1 - 9	10 +
CDPG0604N	6 mm	4 mm	£1.93	£1.74
CDPG0804N	8 mm	4 mm	£2.11	£1.90
CDPG0806N	8 mm	6 mm	£2.11	£1.90
CDPG1006N	10 mm	6 mm	£2.80	£2.52
CDPG1008N	10 mm	8 mm	£2.79	£2.51
CDPG1208N	12 mm	8 mm	£2.93	£2.63
CDPG1210N	12 mm	10 mm	£2.92	£2.63
CDPG1412N	14 mm	12 mm	£2.98	£2.68
CDPG1612N	16 mm	12 mm	£5.21	£4.69

METRIC TUBE TO TUBE



PL – SWIVEL ROTATING MALE ELBOW

3700

PART NUMBER	TUBE OD	THREAD	PRICE EACH	
			1 - 9	10 +
CDPL04M5N	4 mm	M5 x 0.8	£2.38	£2.14
CDPL04M6N	4 mm	M6 x 1.0	£2.38	£2.14
CDPL0401N	4 mm	1/8" BSPT	£2.02	£1.81
CDPL0402N	4 mm	1/4" BSPT	£2.15	£1.93
CDPL0403N	4 mm	3/8" BSPT	£2.62	£2.36
CDPL06M5N	6 mm	M5 x 0.8	£2.42	£2.18
CDPL06M6N	6 mm	M6 x 1.0	£2.42	£2.18
CDPL0601N	6 mm	1/8" BSPT	£2.05	£1.85
CDPL0602N	6 mm	1/4" BSPT	£2.21	£1.98
CDPL0603N	6 mm	3/8" BSPT	£2.58	£2.32
CDPL0604N	6 mm	1/2" BSPT	£3.37	£3.03
CDPL0801N	8 mm	1/8" BSPT	£2.44	£2.19
CDPL0802N	8 mm	1/4" BSPT	£2.57	£2.31
CDPL0803N	8 mm	3/8" BSPT	£2.63	£2.37
CDPL0804N	8 mm	1/2" BSPT	£3.89	£3.50
CDPL1001N	10 mm	1/8" BSPT	£3.28	£2.95
CDPL1002N	10 mm	1/4" BSPT	£3.33	£2.99
CDPL1003N	10 mm	3/8" BSPT	£3.34	£3.01
CDPL1004N	10 mm	1/2" BSPT	£4.00	£3.60
CDPL1201N	12 mm	1/8" BSPT	£3.84	£3.46
CDPL1202N	12 mm	1/4" BSPT	£4.00	£3.60
CDPL1203N	12 mm	3/8" BSPT	£4.14	£3.73
CDPL1204N	12 mm	1/2" BSPT	£4.36	£3.92
CDPL1403N	14 mm	3/8" BSPT	£6.48	£5.83
CDPL1404N	14 mm	1/2" BSPT	£6.98	£6.28
CDPL1603N	16 mm	3/8" BSPT	£9.35	£8.41
CDPL1604N	16 mm	1/2" BSPT	£9.80	£8.82



PL-G – SWIVEL ROTATING MALE ELBOW

3700

PART NUMBER	TUBE OD	THREAD	PRICE EACH	
			1 - 9	10 +
CDPL04G01	4 mm	1/8" BSPP	£2.02	£1.81
CDPL04G02	4 mm	1/4" BSPP	£2.15	£1.93
CDPL04G03	4 mm	3/8" BSPP	£2.62	£2.36
CDPL06G01	6 mm	1/8" BSPP	£2.05	£1.85
CDPL06G02	6 mm	1/4" BSPP	£2.21	£1.98
CDPL06G03	6 mm	3/8" BSPP	£2.58	£2.32
CDPL08G01	8 mm	1/8" BSPP	£2.44	£2.19
CDPL08G02	8 mm	1/4" BSPP	£2.57	£2.31
CDPL08G03	8 mm	3/8" BSPP	£2.63	£2.37
CDPL08G04	8 mm	1/2" BSPP	£3.89	£3.50
CDPL10G01	10 mm	1/8" BSPP	£3.33	£2.99
CDPL10G02	10 mm	1/4" BSPP	£3.28	£2.95
CDPL10G03	10 mm	3/8" BSPP	£3.34	£3.01
CDPL10G04	10 mm	1/2" BSPP	£4.00	£3.60
CDPL12G02	12 mm	1/4" BSPP	£4.00	£3.60
CDPL12G03	12 mm	3/8" BSPP	£4.14	£3.73
CDPL12G04	12 mm	1/2" BSPP	£4.36	£3.92
CDPL14G03	14 mm	3/8" BSPP	£6.48	£5.83
CDPL14G04	14 mm	1/2" BSPP	£6.98	£6.28
CDPL16G03	16 mm	3/8" BSPP	£9.35	£8.41
CDPL16G04	16 mm	1/2" BSPP	£9.80	£8.82



PMM BULKHEAD UNION

3700

PART NUMBER	TUBE OD	TUBE OD	PRICE EACH	
			1 - 9	10 +
CDPMM04N	4 mm	4 mm	£3.26	£2.93
CDPMM06N	6 mm	6 mm	£4.09	£3.68
CDPMM08N	8 mm	8 mm	£4.92	£4.43
CDPMM10N	10 mm	10 mm	£7.03	£6.33
CDPMM12N	12 mm	12 mm	£9.59	£8.63
CDPMM16N	16 mm	16 mm	£16.02	£14.42



PMF FEMALE STRAIGHT BULKHEAD

3700

PART NUMBER	TUBE OD	THREAD	PRICE EACH	
			1 - 9	10 +
CDPMF0401N	4 mm	1/8" BSPT	£4.02	£3.62
CDPMF0402N	4 mm	1/4" BSPT	£4.38	£3.94
CDPMF0403N	4 mm	3/8" BSPT	£4.75	£4.28
CDPMF0601N	6 mm	1/8" BSPT	£4.25	£3.82
CDPMF0602N	6 mm	1/4" BSPT	£4.35	£3.92
CDPMF0603N	6 mm	3/8" BSPT	£4.70	£4.23
CDPMF0801N	8 mm	1/8" BSPT	£4.82	£4.34
CDPMF0802N	8 mm	1/4" BSPT	£5.09	£4.58
CDPMF0803N	8 mm	3/8" BSPT	£5.31	£4.78
CDPMF0804N	8 mm	1/2" BSPT	£5.97	£5.37
CDPMF1001N	10 mm	1/8" BSPT	£6.27	£5.64
CDPMF1002N	10 mm	1/4" BSPT	£6.47	£5.82
CDPMF1003N	10 mm	3/8" BSPT	£6.76	£6.09
CDPMF1004N	10 mm	1/2" BSPT	£7.42	£6.68
CDPMF1202N	12 mm	1/4" BSPT	£7.20	£6.48
CDPMF1203N	12 mm	3/8" BSPT	£7.63	£6.87
CDPMF1204N	12 mm	1/2" BSPT	£8.20	£7.38



PMF-G FEMALE STRAIGHT BULKHEAD

3700

PART NUMBER	TUBE OD	THREAD	PRICE EACH	
			1 - 9	10 +
CDPMF04G01	4 mm	1/8" BSPP	£4.02	£3.62
CDPMF04G02	4 mm	1/4" BSPP	£4.38	£3.94
CDPMF04G03	4 mm	3/8" BSPP	£4.75	£4.28
CDPMF06G01	6 mm	1/8" BSPP	£4.25	£3.82
CDPMF06G02	6 mm	1/4" BSPP	£4.35	£3.92
CDPMF06G03	6 mm	3/8" BSPP	£4.70	£4.23
CDPMF08G01	8 mm	1/8" BSPP	£4.82	£4.34
CDPMF08G02	8 mm	1/4" BSPP	£5.09	£4.58
CDPMF08G03	8 mm	3/8" BSPP	£5.31	£4.78
CDPMF10G02	10 mm	1/4" BSPP	£6.47	£5.82
CDPMF10G03	10 mm	3/8" BSPP	£6.76	£6.09
CDPMF10G04	10 mm	1/2" BSPP	£7.42	£6.68
CDPMF12G02	12 mm	1/4" BSPP	£7.20	£6.48
CDPMF12G03	12 mm	3/8" BSPP	£7.63	£6.87
CDPMF12G04	12 mm	1/2" BSPP	£8.20	£7.38

TUBE TO THREAD

**PPF
CAP**



3700

PART NUMBER	TUBE OD	PRICE EACH	
		1 - 9	10 +
CDPPF04N	4 mm	£1.32	£1.18
CDPPF06N	6 mm	£1.45	£1.30
CDPPF08N	8 mm	£1.58	£1.42
CDPPF10N	10 mm	£1.91	£1.72
CDPPF12N	12 mm	£2.10	£1.89
CDPPF16N	16 mm	£4.12	£3.71

**PT – SWIVEL ROTATING
MALE BRANCH TEE**



3700

PART NUMBER	TUBE OD	THREAD	PRICE EACH	
			1 - 9	10 +
CDPT04M5N	4 mm	M5 x 0.8	£3.16	£2.85
CDPT04M6N	4 mm	M6 x 1.0	£3.16	£2.85
CDPT0401N	4 mm	1/8" BSPT	£2.81	£2.53
CDPT0402N	4 mm	1/4" BSPT	£2.95	£2.66
CDPT0403N	4 mm	3/8" BSPT	£3.68	£3.31
CDPT06M5N	6 mm	M5 x 0.8	£3.49	£3.14
CDPT06M6N	6 mm	M6 x 1.0	£3.49	£3.14
CDPT0601N	6 mm	1/8" BSPT	£3.05	£2.74
CDPT0602N	6 mm	1/4" BSPT	£3.19	£2.87
CDPT0603N	6 mm	3/8" BSPT	£3.72	£3.35
CDPT0604N	6 mm	1/2" BSPT	£4.56	£4.11
CDPT0801N	8 mm	1/8" BSPT	£3.52	£3.17
CDPT0802N	8 mm	1/4" BSPT	£3.60	£3.24
CDPT0803N	8 mm	3/8" BSPT	£3.79	£3.41
CDPT0804N	8 mm	1/2" BSPT	£4.99	£4.49
CDPT1001N	10 mm	1/8" BSPT	£4.35	£3.91
CDPT1002N	10 mm	1/4" BSPT	£4.43	£3.99
CDPT1003N	10 mm	3/8" BSPT	£4.66	£4.20
CDPT1004N	10 mm	1/2" BSPT	£5.14	£4.62
CDPT1201N	12 mm	1/8" BSPT	£4.95	£4.45
CDPT1202N	12 mm	1/4" BSPT	£5.12	£4.61
CDPT1203N	12 mm	3/8" BSPT	£5.24	£4.71
CDPT1204N	12 mm	1/2" BSPT	£5.47	£4.93
CDPT1603N	16 mm	3/8" BSPT	£13.36	£12.02
CDPT1604N	16 mm	1/2" BSPT	£13.85	£12.46

**PLF – SWIVEL ROTATING
FEMALE ELBOW**



3700

PART NUMBER	TUBE OD	THREAD	PRICE EACH	
			1 - 9	10 +
CDPLF04M5N	4 mm	M5 x 0.8	£2.61	£2.35
CDPLF04M6N	4 mm	M6 x 1.0	£2.61	£2.35
CDPLF0401N	4 mm	1/8" BSPT	£2.21	£1.98
CDPLF06M5N	6 mm	M5 x 0.8	£2.65	£2.39
CDPLF06M6N	6 mm	M6 x 1.0	£2.65	£2.39
CDPLF0601N	6 mm	1/8" BSPT	£2.25	£2.02
CDPLF0602N	6 mm	1/4" BSPT	£2.42	£2.17
CDPLF0603N	6 mm	3/8" BSPT	£2.83	£2.55
CDPLF0801N	8 mm	1/8" BSPT	£2.67	£2.40
CDPLF0802N	8 mm	1/4" BSPT	£2.81	£2.53
CDPLF0803N	8 mm	3/8" BSPT	£2.88	£2.59
CDPLF0804N	8 mm	1/2" BSPT	£3.93	£3.54
CDPLF1002N	10 mm	1/4" BSPT	£3.60	£3.24
CDPLF1003N	10 mm	3/8" BSPT	£3.65	£3.29
CDPLF1004N	10 mm	1/2" BSPT	£4.38	£3.94
CDPLF1202N	12 mm	1/4" BSPT	£4.38	£3.94
CDPLF1203N	12 mm	3/8" BSPT	£4.54	£4.08
CDPLF1204N	12 mm	1/2" BSPT	£4.59	£4.13

**PT-G – SWIVEL ROTATING
MALE BRANCH TEE**



3700

PART NUMBER	TUBE OD	THREAD	PRICE EACH	
			1 - 9	10 +
CDPT04G01	4 mm	1/8" BSPP	£2.76	£2.53
CDPT04G02	4 mm	1/4" BSPP	£2.90	£2.66
CDPT04G03	4 mm	3/8" BSPP	£3.60	£3.31
CDPT06G01	6 mm	1/8" BSPP	£2.98	£2.74
CDPT06G02	6 mm	1/4" BSPP	£3.14	£2.87
CDPT06G03	6 mm	3/8" BSPP	£3.66	£3.35
CDPT08G01	8 mm	1/8" BSPP	£3.45	£3.17
CDPT08G02	8 mm	1/4" BSPP	£3.53	£3.24
CDPT08G03	8 mm	3/8" BSPP	£3.71	£3.41
CDPT08G04	8 mm	1/2" BSPP	£4.89	£4.49
CDPT10G01	10 mm	1/8" BSPP	£4.26	£3.91
CDPT10G02	10 mm	1/4" BSPP	£4.34	£3.99
CDPT10G03	10 mm	3/8" BSPP	£4.58	£4.20
CDPT10G04	10 mm	1/2" BSPP	£5.04	£4.62
CDPT12G02	12 mm	1/4" BSPP	£5.02	£4.61
CDPT12G03	12 mm	3/8" BSPP	£5.14	£4.71
CDPT12G04	12 mm	1/2" BSPP	£5.36	£4.93
CDPT16G03	16 mm	3/8" BSPP	£13.10	£12.02
CDPT16G04	16 mm	1/2" BSPP	£13.58	£12.46

**PLF-G – SWIVEL ROTATING
FEMALE ELBOW**



3700

PART NUMBER	TUBE OD	THREAD	PRICE EACH	
			1 - 9	10 +
CDPLF04G01	4 mm	1/8" BSPP	£2.21	£1.98
CDPLF04G02	4 mm	1/4" BSPP	£2.36	£2.12
CDPLF06G01	6 mm	1/8" BSPP	£2.25	£2.02
CDPLF06G02	6 mm	1/4" BSPP	£2.42	£2.17
CDPLF06G03	6 mm	3/8" BSPP	£2.83	£2.55
CDPLF08G01	8 mm	1/8" BSPP	£2.67	£2.40
CDPLF08G02	8 mm	1/4" BSPP	£2.81	£2.53
CDPLF08G03	8 mm	3/8" BSPP	£2.88	£2.59
CDPLF08G04	8 mm	1/2" BSPP	£3.93	£3.54
CDPLF10G01	10 mm	1/8" BSPP	£3.43	£3.09
CDPLF10G02	10 mm	1/4" BSPP	£3.60	£3.24
CDPLF10G03	10 mm	3/8" BSPP	£3.65	£3.29
CDPLF10G04	10 mm	1/2" BSPP	£4.38	£3.94
CDPLF12G02	12 mm	1/4" BSPP	£4.38	£3.94
CDPLF12G03	12 mm	3/8" BSPP	£4.54	£4.08
CDPLF12G04	12 mm	1/2" BSPP	£4.59	£4.13

TUBE TO THREAD



3700

**PTF – SWIVEL ROTATING
FEMALE BRANCH TEE**

PART NUMBER	TUBE OD	THREAD	PRICE EACH	
			1 - 9	10 +
CDPTF04M5N	4 mm	M5 x 0.8	£3.64	£3.28
CDPTF04M6N	4 mm	M6 x 1.0	£3.64	£3.28
CDPTF0401N	4 mm	1/8" BSPT	£3.23	£2.91
CDPTF0402N	4 mm	1/4" BSPT	£3.40	£3.06
CDPTF06M5N	6 mm	M5 x 0.8	£4.00	£3.60
CDPTF06M6N	6 mm	M6 x 1.0	£4.00	£3.60
CDPTF0601N	6 mm	1/8" BSPT	£3.50	£3.15
CDPTF0602N	6 mm	1/4" BSPT	£3.68	£3.31
CDPTF0603N	6 mm	3/8" BSPT	£4.28	£3.86
CDPTF0801N	8 mm	1/8" BSPT	£4.05	£3.64
CDPTF0802N	8 mm	1/4" BSPT	£4.13	£3.72
CDPTF0803N	8 mm	3/8" BSPT	£4.35	£3.92
CDPTF1001N	10 mm	1/8" BSPT	£5.00	£4.50
CDPTF1002N	10 mm	1/4" BSPT	£5.09	£4.58
CDPTF1003N	10 mm	3/8" BSPT	£5.37	£4.83
CDPTF1004N	10 mm	1/2" BSPT	£5.91	£5.32
CDPTF1202N	12 mm	1/4" BSPT	£5.89	£5.30
CDPTF1203N	12 mm	3/8" BSPT	£6.03	£5.42
CDPTF1204N	12 mm	1/2" BSPT	£6.29	£5.66



3700

**PST – SWIVEL ROTATING
MALE RUN TEE**

PART NUMBER	TUBE OD	THREAD	PRICE EACH	
			1 - 9	10 +
CDPST04M5N	4 mm	M5 x 0.8	£2.68	£2.41
CDPST04M6N	4 mm	M6 x 1.0	£2.98	£2.68
CDPST0401N	4 mm	1/8" BSPT	£2.98	£2.68
CDPST0402N	4 mm	1/4" BSPT	£2.98	£2.68
CDPST0403N	4 mm	3/8" BSPT	£3.58	£3.22
CDPST06M5N	6 mm	M5 x 0.8	£2.98	£2.68
CDPST06M6N	6 mm	M6 x 1.0	£2.98	£2.68
CDPST0601N	6 mm	1/8" BSPT	£2.98	£2.68
CDPST0602N	6 mm	1/4" BSPT	£2.98	£2.68
CDPST0603N	6 mm	3/8" BSPT	£3.63	£3.26
CDPST0604N	6 mm	1/2" BSPT	£4.35	£3.91
CDPST0801N	8 mm	1/8" BSPT	£3.16	£2.84
CDPST0802N	8 mm	1/4" BSPT	£3.16	£2.84
CDPST0803N	8 mm	3/8" BSPT	£3.63	£3.26
CDPST0804N	8 mm	1/2" BSPT	£4.52	£4.07
CDPST1001N	10 mm	1/8" BSPT	£3.35	£3.01
CDPST1002N	10 mm	1/4" BSPT	£3.63	£3.26
CDPST1003N	10 mm	3/8" BSPT	£3.63	£3.26
CDPST1004N	10 mm	1/2" BSPT	£3.82	£3.44
CDPST1201N	12 mm	1/8" BSPT	£4.23	£3.81
CDPST1202N	12 mm	1/4" BSPT	£4.40	£3.96
CDPST1203N	12 mm	3/8" BSPT	£5.08	£4.57
CDPST1204N	12 mm	1/2" BSPT	£6.03	£5.43



3700

**PTF-G – SWIVEL ROTATING
FEMALE BRANCH TEE**

PART NUMBER	TUBE OD	THREAD	PRICE EACH	
			1 - 9	10 +
CDPTF04G01	4 mm	1/8" BSPP	£3.23	£2.91
CDPTF04G02	4 mm	1/4" BSPP	£3.40	£3.06
CDPTF06G01	6 mm	1/8" BSPP	£3.50	£3.15
CDPTF06G02	6 mm	1/4" BSPP	£3.68	£3.31
CDPTF06G03	6 mm	3/8" BSPP	£4.28	£3.86
CDPTF08G01	8 mm	1/8" BSPP	£4.05	£3.64
CDPTF08G02	8 mm	1/4" BSPP	£4.13	£3.72
CDPTF08G03	8 mm	3/8" BSPP	£4.35	£3.92
CDPTF08G04	8 mm	1/2" BSPP	£5.73	£5.16
CDPTF10G01	10 mm	1/8" BSPP	£5.00	£4.50
CDPTF10G02	10 mm	1/4" BSPP	£5.09	£4.58
CDPTF10G03	10 mm	3/8" BSPP	£5.37	£4.83
CDPTF10G04	10 mm	1/2" BSPP	£5.91	£5.32
CDPTF12G02	12 mm	1/4" BSPP	£5.89	£5.30
CDPTF12G03	12 mm	3/8" BSPP	£6.03	£5.42
CDPTF12G04	12 mm	1/2" BSPP	£6.29	£5.66



3700

**PST-G – SWIVEL ROTATING
MALE RUN TEE**

PART NUMBER	TUBE OD	THREAD	PRICE EACH	
			1 - 9	10 +
CDPST04G01	4 mm	1/8" BSPP	£2.98	£2.68
CDPST04G02	4 mm	1/4" BSPP	£2.98	£2.68
CDPST04G03	4 mm	3/8" BSPP	£3.58	£3.22
CDPST06G01	6 mm	1/8" BSPP	£2.98	£2.68
CDPST06G02	6 mm	1/4" BSPP	£2.98	£2.68
CDPST06G03	6 mm	3/8" BSPP	£3.63	£3.26
CDPST08G01	8 mm	1/8" BSPP	£3.16	£2.84
CDPST08G02	8 mm	1/4" BSPP	£3.16	£2.84
CDPST08G03	8 mm	3/8" BSPP	£3.63	£3.26
CDPST08G04	8 mm	1/2" BSPP	£4.52	£4.07
CDPST10G01	10 mm	1/8" BSPP	£3.35	£3.01
CDPST10G02	10 mm	1/4" BSPP	£3.63	£3.26
CDPST10G03	10 mm	3/8" BSPP	£3.63	£3.26
CDPST10G04	10 mm	1/2" BSPP	£3.82	£3.44
CDPST12G02	12 mm	1/4" BSPP	£4.40	£3.96
CDPST12G03	12 mm	3/8" BSPP	£5.08	£4.57
CDPST12G04	12 mm	1/2" BSPP	£6.03	£5.43

TUBE TO THREAD



**PWT – SWIVEL ROTATING
MALE 'Y'**

3700

**PL
45° MALE ELBOW**

3700

PART NUMBER	TUBE OD	THREAD	PRICE EACH	
			1 - 9	10 +
CDPWT04M5N	4 mm	M5 x 0.8	£3.71	£3.34
CDPWT04M6N	4 mm	M6 x 1.0	£3.71	£3.34
CDPWT0401N	4 mm	1/8" BSPT	£3.71	£3.34
CDPWT0402N	4 mm	1/4" BSPT	£3.71	£3.34
CDPWT0403N	4 mm	3/8" BSPT	£4.32	£3.89
CDPWT06M5N	6 mm	M5 x 0.8	£3.71	£3.34
CDPWT06M6N	6 mm	M6 x 1.0	£3.71	£3.34
CDPWT0601N	6 mm	1/8" BSPT	£3.71	£3.34
CDPWT0602N	6 mm	1/4" BSPT	£3.71	£3.34
CDPWT0603N	6 mm	3/8" BSPT	£4.33	£3.89
CDPWT0604N	6 mm	1/2" BSPT	£4.57	£4.11
CDPWT0801N	8 mm	1/4" BSPT	£3.88	£3.49
CDPWT0802N	8 mm	1/8" BSPT	£3.88	£3.49
CDPWT0803N	8 mm	3/8" BSPT	£4.33	£3.89
CDPWT0804N	8 mm	1/2" BSPT	£4.59	£4.13
CDPWT1001N	10 mm	1/8" BSPT	£4.49	£4.04
CDPWT1002N	10 mm	1/4" BSPT	£4.06	£3.65
CDPWT1003N	10 mm	3/8" BSPT	£4.33	£3.89
CDPWT1004N	10 mm	1/2" BSPT	£5.10	£4.59
CDPWT1201N	12 mm	1/8" BSPT	£5.37	£4.83
CDPWT1202N	12 mm	1/4" BSPT	£5.50	£4.95
CDPWT1203N	12 mm	3/8" BSPT	£7.30	£6.57
CDPWT1204N	12 mm	1/2" BSPT	£8.04	£7.23

PART NUMBER	OD	THREAD	PRICE EACH	
			1 - 9	10 +
CDPL4504M5N	4 mm	M5	£2.74	£2.46
CDPL4504M6N	4 mm	M6	£2.74	£2.46
CDPL450401N	4 mm	1/8" BSPT	£2.32	£2.09
CDPL450402N	4 mm	1/4" BSPT	£2.47	£2.22
CDPL450403N	4 mm	3/8" BSPT	£3.02	£2.72
CDPL4506M5N	6 mm	M5	£2.79	£2.51
CDPL4506M6N	6 mm	M6	£2.79	£2.51
CDPL450601N	6 mm	1/8" BSPT	£2.36	£2.12
CDPL450602N	6 mm	1/4" BSPT	£2.53	£2.28
CDPL450603N	6 mm	3/8" BSPT	£2.97	£2.67
CDPL450604N	6 mm	1/2" BSPT	£3.87	£3.48
CDPL450801N	8 mm	1/8" BSPT	£2.80	£2.52
CDPL450802N	8 mm	1/4" BSPT	£2.95	£2.66
CDPL450803N	8 mm	3/8" BSPT	£3.02	£2.72
CDPL450804N	8 mm	1/2" BSPT	£4.48	£4.03
CDPL451001N	10 mm	1/8" BSPT	£3.78	£3.40
CDPL451002N	10 mm	1/4" BSPT	£3.82	£3.44
CDPL451003N	10 mm	3/8" BSPT	£3.84	£3.45
CDPL451004N	10 mm	1/2" BSPT	£4.60	£4.14
CDPL451201N	12 mm	1/8" BSPT	£4.42	£3.98
CDPL451202N	12 mm	1/4" BSPT	£4.61	£4.15
CDPL451203N	12 mm	3/8" BSPT	£4.76	£4.28
CDPL451204N	12 mm	1/2" BSPT	£5.01	£4.51



**PWT-G – SWIVEL ROTATING
MALE 'Y'**

3700

**PL-G
45° MALE ELBOW**

3700

PART NUMBER	TUBE OD	THREAD	PRICE EACH	
			1 - 9	10 +
CDPWT04G01	4 mm	1/8" BSPP	£3.71	£3.34
CDPWT04G02	4 mm	1/4" BSPP	£3.71	£3.34
CDPWT04G03	4 mm	3/8" BSPP	£4.32	£3.89
CDPWT06G01	6 mm	1/8" BSPP	£3.71	£3.34
CDPWT06G02	6 mm	1/4" BSPP	£3.71	£3.34
CDPWT06G03	6 mm	3/8" BSPP	£4.33	£3.89
CDPWT08G01	8 mm	1/8" BSPP	£3.88	£3.49
CDPWT08G02	8 mm	1/4" BSPP	£3.88	£3.49
CDPWT08G03	8 mm	3/8" BSPP	£4.33	£3.89
CDPWT08G04	8 mm	1/2" BSPP	£4.59	£4.13
CDPWT10G01	10 mm	1/8" BSPP	£4.49	£4.04
CDPWT10G02	10 mm	1/4" BSPP	£4.06	£3.65
CDPWT10G03	10 mm	3/8" BSPP	£4.33	£3.89
CDPWT10G04	10 mm	1/2" BSPP	£5.10	£4.59
CDPWT12G02	12 mm	1/4" BSPP	£5.50	£4.95
CDPWT12G03	12 mm	3/8" BSPP	£7.30	£6.57
CDPWT12G04	12 mm	1/2" BSPP	£8.04	£7.23

PART NUMBER	OD	THREAD	PRICE EACH	
			1 - 9	10 +
CDPL4504G01	4 mm	1/8" BSPP	£2.32	£2.09
CDPL4504G02	4 mm	1/4" BSPP	£2.47	£2.22
CDPL4504G03	4 mm	3/8" BSPP	£3.02	£2.72
CDPL4506G01	6 mm	1/8" BSPP	£2.36	£2.12
CDPL4506G02	6 mm	1/4" BSPP	£2.53	£2.28
CDPL4506G03	6 mm	3/8" BSPP	£2.97	£2.67
CDPL4506G04	6 mm	1/2" BSPP	£3.87	£3.48
CDPL4508G01	8 mm	1/8" BSPP	£2.80	£2.52
CDPL4508G02	8 mm	1/4" BSPP	£2.95	£2.66
CDPL4508G03	8 mm	3/8" BSPP	£3.02	£2.72
CDPL4508G04	8 mm	1/2" BSPP	£4.48	£4.03
CDPL4510G01	10 mm	1/8" BSPP	£3.82	£3.44
CDPL4510G02	10 mm	1/4" BSPP	£3.78	£3.40
CDPL4510G03	10 mm	3/8" BSPP	£3.84	£3.45
CDPL4510G04	10 mm	1/2" BSPP	£4.60	£4.14
CDPL4512G02	12 mm	1/4" BSPP	£4.61	£4.15
CDPL4512G03	12 mm	3/8" BSPP	£4.76	£4.28
CDPL4512G04	12 mm	1/2" BSPP	£5.01	£4.51

TUBE TO THREAD



**PLL – SWIVEL ROTATING
EXTENDED MALE ELBOW**

3700

PART NUMBER	TUBE OD	THREAD	PRICE EACH	
			1 - 9	10 +
CDPLL04M5N	4 mm	M5 x 0.8	£3.19	£2.87
CDPLL04M6N	4 mm	M6 x 1.0	£3.19	£2.87
CDPLL0401N	4 mm	1/8" BSPT	£3.04	£2.73
CDPLL0402N	4 mm	1/4" BSPT	£3.27	£2.94
CDPLL0403N	4 mm	3/8" BSPT	£4.03	£3.62
CDPLL06M5N	6 mm	M5 x 0.8	£3.31	£2.98
CDPLL06M6N	6 mm	M6 x 1.0	£3.31	£2.98
CDPLL0601N	6 mm	1/8" BSPT	£3.35	£3.02
CDPLL0602N	6 mm	1/4" BSPT	£3.52	£3.17
CDPLL0603N	6 mm	3/8" BSPT	£4.19	£3.77
CDPLL0604N	6 mm	1/2" BSPT	£5.12	£4.61
CDPLL0801N	8 mm	1/8" BSPT	£3.63	£3.26
CDPLL0802N	8 mm	1/4" BSPT	£3.77	£3.40
CDPLL0803N	8 mm	3/8" BSPT	£4.57	£4.11
CDPLL0804N	8 mm	1/2" BSPT	£5.61	£5.05
CDPLL1001N	10 mm	1/8" BSPT	£4.59	£4.13
CDPLL1002N	10 mm	1/4" BSPT	£4.70	£4.23
CDPLL1003N	10 mm	3/8" BSPT	£4.84	£4.35
CDPLL1004N	10 mm	1/2" BSPT	£6.66	£5.99
CDPLL1201N	12 mm	1/8" BSPT	£6.59	£5.93
CDPLL1202N	12 mm	1/4" BSPT	£6.78	£6.10
CDPLL1203N	12 mm	3/8" BSPT	£7.11	£6.40
CDPLL1204N	12 mm	1/2" BSPT	£7.41	£6.67



**PLL - SWIVEL ROTATING
EXTENDED MALE ELBOW**

3700

PART NUMBER	TUBE OD	THREAD	PRICE EACH	
			1 - 9	10 +
CDPLL04M5N	4 mm	M5 x 0.8	£2.60	£2.34
CDPLL04M6N	4 mm	M6 x 1.0	£2.63	£2.36
CDPLL0401N	4 mm	1/8" BSPT	£2.05	£1.85
CDPLL0402N	4 mm	1/4" BSPT	£2.71	£2.44
CDPLL0403N	4 mm	3/8" BSPT	£3.26	£2.93
CDPLL06M5N	6 mm	M5 x 0.8	£2.86	£2.58
CDPLL06M6N	6 mm	M6 x 1.0	£2.89	£2.60
CDPLL0601N	6 mm	1/8" BSPT	£2.38	£2.14
CDPLL0602N	6 mm	1/4" BSPT	£2.87	£2.58
CDPLL0603N	6 mm	3/8" BSPT	£3.54	£3.19
CDPLL0604N	6 mm	1/2" BSPT	£4.82	£4.33
CDPLL0801N	8 mm	1/8" BSPT	£2.63	£2.36
CDPLL0802N	8 mm	1/4" BSPT	£2.98	£2.68
CDPLL0803N	8 mm	3/8" BSPT	£3.63	£3.27
CDPLL0804N	8 mm	1/2" BSPT	£4.77	£4.30
CDPLL1001N	10 mm	1/8" BSPT	£3.42	£3.07
CDPLL1002N	10 mm	1/4" BSPT	£3.68	£3.31
CDPLL1003N	10 mm	3/8" BSPT	£3.78	£3.40
CDPLL1004N	10 mm	1/2" BSPT	£5.03	£4.53
CDPLL1201N	12 mm	1/8" BSPT	£4.31	£3.87
CDPLL1202N	12 mm	1/4" BSPT	£4.58	£4.12
CDPLL1203N	12 mm	3/8" BSPT	£4.54	£4.09
CDPLL1204N	12 mm	1/2" BSPT	£5.23	£4.71



**PLL-G – SWIVEL ROTATING
EXTENDED MALE ELBOW**

3700

PART NUMBER	TUBE OD	THREAD	PRICE EACH	
			1 - 9	10 +
CDPLL04G01	4 mm	1/8" BSPP	£3.04	£2.73
CDPLL04G02	4 mm	1/4" BSPP	£3.27	£2.94
CDPLL04G03	4 mm	3/8" BSPP	£4.03	£3.62
CDPLL06G01	6 mm	1/8" BSPP	£3.35	£3.02
CDPLL06G02	6 mm	1/4" BSPP	£3.52	£3.17
CDPLL06G03	6 mm	3/8" BSPP	£4.19	£3.77
CDPLL08G01	8 mm	1/8" BSPP	£3.63	£3.26
CDPLL08G02	8 mm	1/4" BSPP	£3.77	£3.40
CDPLL08G03	8 mm	3/8" BSPP	£4.57	£4.11
CDPLL08G04	8 mm	1/2" BSPP	£5.61	£5.05
CDPLL10G01	10 mm	1/8" BSPP	£4.59	£4.13
CDPLL10G02	10 mm	1/4" BSPP	£4.70	£4.23
CDPLL10G03	10 mm	3/8" BSPP	£4.84	£4.35
CDPLL10G04	10 mm	1/2" BSPP	£6.66	£5.99
CDPLL12G02	12 mm	1/4" BSPP	£6.78	£6.10
CDPLL12G03	12 mm	3/8" BSPP	£7.11	£6.40
CDPLL12G04	12 mm	1/2" BSPP	£7.41	£6.67



**PLL-G – SWIVEL ROTATING
EXTENDED MALE ELBOW**

3700

PART NUMBER	TUBE OD	THREAD	PRICE EACH	
			1 - 9	10 +
CDPLL04G01	4 mm	1/8" BSPP	£2.05	£1.85
CDPLL04G02	4 mm	1/4" BSPP	£2.71	£2.44
CDPLL04G03	4 mm	3/8" BSPP	£3.26	£2.93
CDPLL06G01	6 mm	1/8" BSPP	£2.38	£2.14
CDPLL06G02	6 mm	1/4" BSPP	£2.87	£2.58
CDPLL06G03	6 mm	3/8" BSPP	£3.54	£3.19
CDPLL08G01	8 mm	1/8" BSPP	£2.63	£2.36
CDPLL08G02	8 mm	1/4" BSPP	£2.98	£2.68
CDPLL08G03	8 mm	3/8" BSPP	£3.63	£3.27
CDPLL08G04	8 mm	1/2" BSPP	£4.77	£4.30
CDPLL10G01	10 mm	1/8" BSPP	£3.42	£3.07
CDPLL10G02	10 mm	1/4" BSPP	£3.68	£3.31
CDPLL10G03	10 mm	3/8" BSPP	£3.78	£3.40
CDPLL10G04	10 mm	1/2" BSPP	£5.03	£4.53
CDPLL12G02	12 mm	1/4" BSPP	£4.58	£4.12
CDPLL12G03	12 mm	3/8" BSPP	£4.54	£4.09
CDPLL12G04	12 mm	1/2" BSPP	£5.23	£4.71

TUBE TO THREAD



PXT
MALE DOUBLE 'Y'

3700

PART NUMBER	TUBE OD	THREAD	PRICE EACH	
			1 - 9	10 +
CDPXT0401	4 mm	1/8" BSPT	£8.16	£7.34
CDPXT0402	4 mm	1/4" BSPT	£8.36	£7.52
CDPXT0601	6 mm	1/8" BSPT	£10.81	£9.73
CDPXT0602	6 mm	1/4" BSPT	£11.01	£9.91

PXT-G
MALE DOUBLE 'Y'

3700

PART NUMBER	TUBE OD	THREAD	PRICE EACH	
			1 - 9	10 +
CDPXT04G01	4 mm	1/8" BSPP	£8.16	£7.34
CDPXT04G02	4 mm	1/4" BSPP	£8.36	£7.52
CDPXT06G01	6 mm	1/8" BSPP	£10.81	£9.73
CDPXT06G02	6 mm	1/4" BSPP	£11.01	£9.91



PH - SWIVEL ROTATING
MALE BANJO

3700

PART NUMBER	TUBE OD	THREAD	PRICE EACH	
			1 - 9	10 +
CDPH04M5N	4 mm	M5 x 0.8	£2.99	£2.69
CDPH04M6N	4 mm	M6 x 1.0	£3.32	£2.99
CDPH0401N	4 mm	1/8" BSPT	£3.29	£2.96
CDPH0402N	4 mm	1/4" BSPT	£3.63	£3.26
CDPH06M5N	6 mm	M5 x 0.8	£3.86	£3.48
CDPH06M6N	6 mm	M6 x 1.0	£3.86	£3.48
CDPH0601N	6 mm	1/8" BSPT	£3.89	£3.50
CDPH0602N	6 mm	1/4" BSPT	£3.97	£3.57
CDPH0603N	6 mm	3/8" BSPT	£4.14	£3.73
CDPH0801N	8 mm	1/8" BSPT	£4.35	£3.92
CDPH0802N	8 mm	1/4" BSPT	£4.37	£3.93
CDPH0803N	8 mm	3/8" BSPT	£5.01	£4.50
CDPH0804N	8 mm	1/2" BSPT	£6.04	£5.44
CDPH1001N	10 mm	1/8" BSPT	£4.66	£4.19
CDPH1002N	10 mm	1/4" BSPT	£4.72	£4.25
CDPH1003N	10 mm	3/8" BSPT	£4.98	£4.48
CDPH1004N	10 mm	1/2" BSPT	£6.53	£5.88
CDPH1202N	12 mm	1/4" BSPT	£7.11	£6.39
CDPH1203N	12 mm	3/8" BSPT	£7.46	£6.71
CDPH1204N	12 mm	1/2" BSPT	£8.58	£7.72



PH-G - SWIVEL ROTATING
MALE BANJO

3700

PART NUMBER	TUBE OD	THREAD	PRICE EACH	
			1 - 9	10 +
CDPH04G01	4 mm	1/8" BSPP	£3.29	£2.96
CDPH04G02	4 mm	1/4" BSPP	£3.63	£3.26
CDPH06G01	6 mm	1/8" BSPP	£3.89	£3.50
CDPH06G02	6 mm	1/4" BSPP	£3.97	£3.57
CDPH06G03	6 mm	3/8" BSPP	£4.14	£3.73
CDPH08G01	8 mm	1/8" BSPP	£4.35	£3.92
CDPH08G02	8 mm	1/4" BSPP	£4.37	£3.93
CDPH08G03	8 mm	3/8" BSPP	£5.01	£4.50
CDPH08G04	8 mm	1/2" BSPP	£6.04	£5.44
CDPH10G02	10 mm	1/4" BSPP	£4.72	£4.25
CDPH10G03	10 mm	3/8" BSPP	£4.98	£4.48
CDPH10G04	10 mm	1/2" BSPP	£6.53	£5.88
CDPH12G03	12 mm	3/8" BSPP	£7.46	£6.71
CDPH12G04	12 mm	1/2" BSPP	£8.58	£7.72



PHF - SWIVEL ROTATING
FEMALE STACKING BANJO

3700

PART NUMBER	TUBE OD	THREAD	PRICE EACH	
			1 - 9	10 +
CDPHF04M5N	4 mm	M5 x 0.8	£3.65	£3.29
CDPHF04M6N	4 mm	M6 x 1.0	£3.65	£3.29
CDPHF0401N	4 mm	1/8" BSPT	£3.62	£3.26
CDPHF06M5N	6 mm	M5 x 0.8	£4.26	£3.83
CDPHF06M6N	6 mm	M6 x 1.0	£4.26	£3.83
CDPHF0601N	6 mm	1/8" BSPT	£4.28	£3.85
CDPHF0602N	6 mm	1/4" BSPT	£4.37	£3.93
CDPHF0801N	8 mm	1/8" BSPT	£4.80	£4.32
CDPHF0802N	8 mm	1/4" BSPT	£4.80	£4.32
CDPHF0803N	8 mm	3/8" BSPT	£5.51	£4.96
CDPHF0804N	8 mm	1/2" BSPT	£6.64	£5.98
CDPHF1002N	10 mm	1/4" BSPT	£5.19	£4.67
CDPHF1003N	10 mm	3/8" BSPT	£5.47	£4.93
CDPHF1004N	10 mm	1/2" BSPT	£7.18	£6.46
CDPHF1203N	12 mm	3/8" BSPT	£8.20	£7.38
CDPHF1204N	12 mm	1/2" BSPT	£9.44	£8.50



PHF-G
FEMALE STACKING BANJO

3700

PART NUMBER	TUBE OD	THREAD	PRICE EACH	
			1 - 9	10 +
CDPHF04G01	4 mm	1/8" BSPP	£4.30	£3.87
CDPHF04G02	4 mm	1/4" BSPP	£6.03	£5.42
CDPHF04G03	4 mm	3/8" BSPP	£8.24	£7.42
CDPHF04G04	4 mm	1/2" BSPP	£10.86	£9.77
CDPHF06G01	6 mm	1/8" BSPP	£4.41	£3.97
CDPHF06G02	6 mm	1/4" BSPP	£6.15	£5.53
CDPHF06G03	6 mm	3/8" BSPP	£8.36	£7.52
CDPHF06G04	6 mm	1/2" BSPP	£10.98	£9.88
CDPHF08G01	8 mm	1/8" BSPP	£4.55	£4.10
CDPHF08G02	8 mm	1/4" BSPP	£6.29	£5.66
CDPHF08G03	8 mm	3/8" BSPP	£8.50	£7.65
CDPHF08G04	8 mm	1/2" BSPP	£11.12	£10.00
CDPHF10G01	10 mm	1/8" BSPP	£4.82	£4.34
CDPHF10G02	10 mm	1/4" BSPP	£6.55	£5.90
CDPHF10G03	10 mm	3/8" BSPP	£8.77	£7.89
CDPHF10G04	10 mm	1/2" BSPP	£11.38	£10.24
CDPHF12G02	12 mm	1/4" BSPP	£6.99	£6.29
CDPHF12G03	12 mm	3/8" BSPP	£9.20	£8.28
CDPHF12G04	12 mm	1/2" BSPP	£11.82	£10.63

TUBE TO THREAD

PHL
DOUBLE UNIVERSAL ELBOW



3700

PART NUMBER	TUBE OD	THREAD	PRICE EACH	
			1 - 9	10 +
CDPHL0401-2	4 mm	1/8" BSPT	£9.05	£8.15
CDPHL0402-2	4 mm	1/4" BSPT	£11.64	£10.48
CDPHL0403-2	4 mm	3/8" BSPT	£15.28	£13.75
CDPHL0404-2	4 mm	1/2" BSPT	£19.59	£17.63
CDPHL0601-2	6 mm	1/8" BSPT	£9.30	£8.37
CDPHL0602-2	6 mm	1/4" BSPT	£11.89	£10.70
CDPHL0603-2	6 mm	3/8" BSPT	£15.53	£13.97
CDPHL0604-2	6 mm	1/2" BSPT	£19.84	£17.85
CDPHL0801-2	8 mm	1/8" BSPT	£9.60	£8.64
CDPHL0802-2	8 mm	1/4" BSPT	£12.19	£10.97
CDPHL0803-2	8 mm	3/8" BSPT	£15.83	£14.24
CDPHL0804-2	8 mm	1/2" BSPT	£20.13	£18.12
CDPHL1001-2	10 mm	1/8" BSPT	£10.17	£9.15
CDPHL1002-2	10 mm	1/4" BSPT	£12.75	£11.48
CDPHL1003-2	10 mm	3/8" BSPT	£16.39	£14.75
CDPHL1004-2	10 mm	1/2" BSPT	£20.70	£18.63
CDPHL1202-2	12 mm	1/4" BSPT	£18.99	£17.09
CDPHL1203-2	12 mm	3/8" BSPT	£23.63	£21.26
CDPHL1204-2	12 mm	1/2" BSPT	£29.08	£26.17

PHL-G
DOUBLE UNIVERSAL ELBOW



3700

PART NUMBER	TUBE OD	THREAD	PRICE EACH	
			1 - 9	10 +
CDPHL04G012	4 mm	1/8" BSPP	£9.05	£8.15
CDPHL04G022	4 mm	1/4" BSPP	£11.64	£10.48
CDPHL04G032	4 mm	3/8" BSPP	£15.28	£13.75
CDPHL04G042	4 mm	1/2" BSPP	£19.59	£17.63
CDPHL06G012	6 mm	1/8" BSPP	£9.30	£8.37
CDPHL06G022	6 mm	1/4" BSPP	£11.89	£10.70
CDPHL06G032	6 mm	3/8" BSPP	£15.53	£13.97
CDPHL06G042	6 mm	1/2" BSPP	£19.84	£17.85
CDPHL08G012	8 mm	1/8" BSPP	£9.60	£8.64
CDPHL08G022	8 mm	1/4" BSPP	£12.19	£10.97
CDPHL08G032	8 mm	3/8" BSPP	£15.83	£14.24
CDPHL08G042	8 mm	1/2" BSPP	£20.13	£18.12
CDPHL10G012	10 mm	1/8" BSPP	£10.17	£9.15
CDPHL10G022	10 mm	1/4" BSPP	£12.75	£11.48
CDPHL10G032	10 mm	3/8" BSPP	£16.39	£14.75
CDPHL10G042	10 mm	1/2" BSPP	£20.70	£18.63
CDPHL12G022	12 mm	1/4" BSPP	£18.99	£17.09
CDPHL12G032	12 mm	3/8" BSPP	£23.63	£21.26
CDPHL12G042	12 mm	1/2" BSPP	£29.08	£26.17

PHL
TRIPLE UNIVERSAL ELBOW



3700

PART NUMBER	TUBE OD	THREAD	PRICE EACH	
			1 - 9	10 +
CDPHL0401-3	4 mm	1/8" BSPT	£11.86	£10.67
CDPHL0402-3	4 mm	1/4" BSPT	£15.95	£14.35
CDPHL0403-3	4 mm	3/8" BSPT	£20.58	£18.52
CDPHL0404-3	4 mm	1/2" BSPT	£26.03	£23.42
CDPHL0601-3	6 mm	1/8" BSPT	£12.23	£11.01
CDPHL0602-3	6 mm	1/4" BSPT	£16.32	£14.69
CDPHL0603-3	6 mm	3/8" BSPT	£20.95	£18.86
CDPHL0604-3	6 mm	1/2" BSPT	£26.40	£23.76
CDPHL0801-3	8 mm	1/8" BSPT	£12.68	£11.41
CDPHL0802-3	8 mm	1/4" BSPT	£16.77	£15.09
CDPHL0803-3	8 mm	3/8" BSPT	£21.40	£19.26
CDPHL0804-3	8 mm	1/2" BSPT	£26.85	£24.16
CDPHL1001-3	10 mm	1/8" BSPT	£13.53	£12.18
CDPHL1002-3	10 mm	1/4" BSPT	£17.62	£15.86
CDPHL1003-3	10 mm	3/8" BSPT	£22.25	£20.03
CDPHL1004-3	10 mm	1/2" BSPT	£27.70	£24.93
CDPHL1202-3	12 mm	1/4" BSPT	£18.99	£17.09
CDPHL1203-3	12 mm	3/8" BSPT	£23.63	£21.26
CDPHL1204-3	12 mm	1/2" BSPT	£29.08	£26.17

PHL-G
TRIPLE UNIVERSAL ELBOW



3700

PART NUMBER	TUBE OD	THREAD	PRICE EACH	
			1 - 9	10 +
CDPHL04G013	4 mm	1/8" BSPP	£11.86	£10.67
CDPHL04G023	4 mm	1/4" BSPP	£15.95	£14.35
CDPHL04G033	4 mm	3/8" BSPP	£20.58	£18.52
CDPHL04G043	4 mm	1/2" BSPP	£26.03	£23.42
CDPHL06G013	6 mm	1/8" BSPP	£12.23	£11.01
CDPHL06G023	6 mm	1/4" BSPP	£16.32	£14.69
CDPHL06G033	6 mm	3/8" BSPP	£20.95	£18.86
CDPHL06G043	6 mm	1/2" BSPP	£26.40	£23.76
CDPHL08G013	8 mm	1/8" BSPP	£12.68	£11.41
CDPHL08G023	8 mm	1/4" BSPP	£16.77	£15.09
CDPHL08G033	8 mm	3/8" BSPP	£21.40	£19.26
CDPHL08G043	8 mm	1/2" BSPP	£26.85	£24.16
CDPHL10G013	10 mm	1/8" BSPP	£13.53	£12.18
CDPHL10G023	10 mm	1/4" BSPP	£17.62	£15.86
CDPHL10G033	10 mm	3/8" BSPP	£22.25	£20.03
CDPHL10G043	10 mm	1/2" BSPP	£27.70	£24.93
CDPHL12G023	12 mm	1/4" BSPP	£18.99	£17.09
CDPHL12G033	12 mm	3/8" BSPP	£23.63	£21.26
CDPHL12G043	12 mm	1/2" BSPP	£29.08	£26.17

PKD
MALE REDUCER TRIPLE
BRANCH UNION



3700

PART NUMBER	TUBE OD (A)	TUBE OD (B)	THREAD	PRICE EACH	
				1 - 9	10 +
CDPKD06041	6 mm	4 mm	1/8" BSPT	£9.52	£8.57
CDPKD08042	8 mm	4 mm	1/4" BSPT	£10.25	£9.22
CDPKD08062	8 mm	6 mm	1/4" BSPT	£11.02	£9.92
CDPKD10083	10 mm	8 mm	3/8" BSPT	£10.82	£9.73

PKD-G
MALE REDUCER TRIPLE
BRANCH UNION



3700

PART NUMBER	TUBE OD (A)	TUBE OD (B)	THREAD	PRICE EACH	
				1 - 9	10 +
CDPKD0604G1	6 mm	4 mm	1/8" BSPP	£9.52	£8.57
CDPKD0804G2	8 mm	4 mm	1/4" BSPP	£10.25	£9.22
CDPKD0806G2	8 mm	6 mm	1/4" BSPP	£11.02	£9.92
CDPKD1006G3	10 mm	6 mm	3/8" BSPP	£10.82	£9.73
CDPKD1008G3	10 mm	8 mm	3/8" BSPP	£10.82	£9.73

TUBE TO THREAD



**PHT
SINGLE UNIVERSAL TEE**

3700

PART NUMBER	TUBE OD	THREAD	PRICE EACH	
			1 - 9	10 +
CDPHT0401-1	4 mm	1/8" BSPT	£6.31	£5.68
CDPHT0402-1	4 mm	1/4" BSPT	£8.06	£7.25
CDPHT0403-1	4 mm	3/8" BSPT	£10.75	£9.67
CDPHT0404-1	4 mm	1/2" BSPT	£13.72	£12.35
CDPHT0601-1	6 mm	1/8" BSPT	£6.56	£5.90
CDPHT0602-1	6 mm	1/4" BSPT	£8.31	£7.48
CDPHT0603-1	6 mm	3/8" BSPT	£11.00	£9.90
CDPHT0604-1	6 mm	1/2" BSPT	£13.97	£12.57
CDPHT0801-1	8 mm	1/8" BSPT	£6.86	£6.17
CDPHT0802-1	8 mm	1/4" BSPT	£8.60	£7.74
CDPHT0803-1	8 mm	3/8" BSPT	£11.29	£10.16
CDPHT0804-1	8 mm	1/2" BSPT	£14.27	£12.84
CDPHT1001-1	10 mm	1/8" BSPT	£7.44	£6.70
CDPHT1002-1	10 mm	1/4" BSPT	£9.18	£8.26
CDPHT1003-1	10 mm	3/8" BSPT	£11.87	£10.68
CDPHT1004-1	10 mm	1/2" BSPT	£14.83	£13.35
CDPHT1202-1	12 mm	1/4" BSPT	£10.09	£9.08
CDPHT1203-1	12 mm	3/8" BSPT	£12.78	£11.50
CDPHT1204-1	12 mm	1/2" BSPT	£15.75	£14.18



**PHT-G
SINGLE UNIVERSAL TEE**

3700

PART NUMBER	TUBE OD	THREAD	PRICE EACH	
			1 - 9	10 +
CDPHT04G11	4 mm	1/8" BSPP	£6.31	£5.68
CDPHT04G21	4 mm	1/4" BSPP	£8.06	£7.25
CDPHT04G31	4 mm	3/8" BSPP	£10.75	£9.67
CDPHT04G41	4 mm	1/2" BSPP	£13.72	£12.35
CDPHT06G11	6 mm	1/8" BSPP	£6.56	£5.90
CDPHT06G21	6 mm	1/4" BSPP	£8.31	£7.48
CDPHT06G31	6 mm	3/8" BSPP	£11.00	£9.90
CDPHT06G41	6 mm	1/2" BSPP	£13.97	£12.57
CDPHT08G11	8 mm	1/8" BSPP	£6.86	£6.17
CDPHT08G21	8 mm	1/4" BSPP	£8.60	£7.74
CDPHT08G31	8 mm	3/8" BSPP	£11.29	£10.16
CDPHT08G41	8 mm	1/2" BSPP	£14.27	£12.84
CDPHT10G11	10 mm	1/8" BSPP	£7.44	£6.70
CDPHT10G21	10 mm	1/4" BSPP	£9.18	£8.26
CDPHT10G31	10 mm	3/8" BSPP	£11.87	£10.68
CDPHT10G41	10 mm	1/2" BSPP	£14.83	£13.35
CDPHT12G21	12 mm	1/4" BSPP	£10.09	£9.08
CDPHT12G31	12 mm	3/8" BSPP	£12.78	£11.50
CDPHT12G41	12 mm	1/2" BSPP	£15.75	£14.18



**PHT
DOUBLE UNIVERSAL TEE**

3700

PART NUMBER	TUBE OD	THREAD	PRICE EACH	
			1 - 9	10 +
CDPHT0401-2	4 mm	1/8" BSPT	£10.43	£9.39
CDPHT0402-2	4 mm	1/4" BSPT	£13.01	£11.71
CDPHT0403-2	4 mm	3/8" BSPT	£16.65	£14.99
CDPHT0404-2	4 mm	1/2" BSPT	£20.97	£18.87
CDPHT0601-2	6 mm	1/8" BSPT	£10.93	£9.83
CDPHT0602-2	6 mm	1/4" BSPT	£13.51	£12.16
CDPHT0603-2	6 mm	3/8" BSPT	£17.15	£15.44
CDPHT0604-2	6 mm	1/2" BSPT	£21.46	£19.32
CDPHT0801-2	8 mm	1/8" BSPT	£11.52	£10.37
CDPHT0802-2	8 mm	1/4" BSPT	£14.11	£12.69
CDPHT0803-2	8 mm	3/8" BSPT	£17.75	£15.97
CDPHT0804-2	8 mm	1/2" BSPT	£22.06	£19.85
CDPHT1001-2	10 mm	1/8" BSPT	£12.66	£11.39
CDPHT1002-2	10 mm	1/4" BSPT	£15.24	£13.72
CDPHT1003-2	10 mm	3/8" BSPT	£18.88	£16.99
CDPHT1004-2	10 mm	1/2" BSPT	£23.19	£20.87
CDPHT1202-2	12 mm	1/4" BSPT	£24.10	£21.69
CDPHT1203-2	12 mm	3/8" BSPT	£28.74	£25.86
CDPHT1204-2	12 mm	1/2" BSPT	£34.19	£30.77



**PHT-G
DOUBLE UNIVERSAL TEE**

3700

PART NUMBER	TUBE OD	THREAD	PRICE EACH	
			1 - 9	10 +
CDPHT04G12	4 mm	1/8" BSPP	£10.43	£9.39
CDPHT04G22	4 mm	1/4" BSPP	£13.01	£11.71
CDPHT04G32	4 mm	3/8" BSPP	£16.65	£14.99
CDPHT04G42	4 mm	1/2" BSPP	£20.97	£18.87
CDPHT06G12	6 mm	1/8" BSPP	£10.93	£9.83
CDPHT06G22	6 mm	1/4" BSPP	£13.51	£12.16
CDPHT06G32	6 mm	3/8" BSPP	£17.15	£15.44
CDPHT06G42	6 mm	1/2" BSPP	£21.46	£19.32
CDPHT08G12	8 mm	1/8" BSPP	£11.52	£10.37
CDPHT08G22	8 mm	1/4" BSPP	£14.11	£12.69
CDPHT08G32	8 mm	3/8" BSPP	£17.75	£15.97
CDPHT08G42	8 mm	1/2" BSPP	£22.06	£19.85
CDPHT10G12	10 mm	1/8" BSPP	£12.66	£11.39
CDPHT10G22	10 mm	1/4" BSPP	£15.24	£13.72
CDPHT10G32	10 mm	3/8" BSPP	£18.88	£16.99
CDPHT10G42	10 mm	1/2" BSPP	£23.19	£20.87
CDPHT12G22	12 mm	1/4" BSPP	£24.10	£21.69
CDPHT12G32	12 mm	3/8" BSPP	£28.74	£25.86
CDPHT12G42	12 mm	1/2" BSPP	£34.19	£30.77

TUBE TO THREAD



PHT
TRIPLE UNIVERSAL TEE

3700

PART NUMBER	TUBE OD	THREAD	PRICE EACH	
			1 - 9	10 +
CDPHT0401-3	4 mm	1/8" BSPT	£13.92	£12.53
CDPHT0402-3	4 mm	1/4" BSPT	£18.01	£16.21
CDPHT0403-3	4 mm	3/8" BSPT	£22.65	£20.38
CDPHT0404-3	4 mm	1/2" BSPT	£28.09	£25.28
CDPHT0601-3	6 mm	1/8" BSPT	£14.67	£13.20
CDPHT0602-3	6 mm	1/4" BSPT	£18.75	£16.88
CDPHT0603-3	6 mm	3/8" BSPT	£23.39	£21.05
CDPHT0604-3	6 mm	1/2" BSPT	£28.84	£25.96
CDPHT0801-3	8 mm	1/8" BSPT	£15.56	£14.00
CDPHT0802-3	8 mm	1/4" BSPT	£19.65	£17.68
CDPHT0803-3	8 mm	3/8" BSPT	£24.28	£21.85
CDPHT0804-3	8 mm	1/2" BSPT	£29.73	£26.76
CDPHT1001-3	10 mm	1/8" BSPT	£17.26	£15.54
CDPHT1002-3	10 mm	1/4" BSPT	£21.36	£19.22
CDPHT1003-3	10 mm	3/8" BSPT	£25.99	£23.39
CDPHT1004-3	10 mm	1/2" BSPT	£31.44	£28.29
CDPHT1202-3	12 mm	1/4" BSPT	£24.10	£21.69
CDPHT1203-3	12 mm	3/8" BSPT	£28.74	£25.86
CDPHT1204-3	12 mm	1/2" BSPT	£34.19	£30.77



PHT-G
TRIPLE UNIVERSAL TEE

3700

PART NUMBER	TUBE OD	THREAD	PRICE EACH	
			1 - 9	10 +
CDPHT04G13	4 mm	1/8" BSPP	£13.92	£12.53
CDPHT04G23	4 mm	1/4" BSPP	£18.01	£16.21
CDPHT04G33	4 mm	3/8" BSPP	£22.65	£20.38
CDPHT04G43	4 mm	1/2" BSPP	£28.09	£25.28
CDPHT06G13	6 mm	1/8" BSPP	£14.67	£13.20
CDPHT06G23	6 mm	1/4" BSPP	£18.75	£16.88
CDPHT06G33	6 mm	3/8" BSPP	£23.39	£21.05
CDPHT06G43	6 mm	1/2" BSPP	£28.84	£25.96
CDPHT08G13	8 mm	1/8" BSPP	£15.56	£14.00
CDPHT08G23	8 mm	1/4" BSPP	£19.65	£17.68
CDPHT08G33	8 mm	3/8" BSPP	£24.28	£21.85
CDPHT08G43	8 mm	1/2" BSPP	£29.73	£26.76
CDPHT10G13	10 mm	1/8" BSPP	£17.26	£15.54
CDPHT10G23	10 mm	1/4" BSPP	£21.36	£19.22
CDPHT10G33	10 mm	3/8" BSPP	£25.99	£23.39
CDPHT10G43	10 mm	1/2" BSPP	£31.44	£28.29
CDPHT12G23	12 mm	1/4" BSPP	£24.10	£21.69
CDPHT12G33	12 mm	3/8" BSPP	£28.74	£25.86
CDPHT12G43	12 mm	1/2" BSPP	£34.19	£30.77



PA
DUAL MALE BANJO

3700

PART NUMBER	TUBE OD	THREAD	PRICE EACH	
			1 - 9	10 +
CDPA04M5	4 mm	M5 x 0.8	£6.70	£6.03
CDPA0601	6 mm	1/8" BSPT	£6.49	£5.84
CDPA0802	8 mm	1/4" BSPT	£8.45	£7.60
CDPA1002	10 mm	1/4" BSPT	£9.99	£8.99
CDPA1003	10 mm	3/8" BSPT	£11.43	£10.29
CDPA1203	12 mm	3/8" BSPT	£12.65	£11.38
CDPA1204	12 mm	1/2" BSPT	£14.41	£12.97



PA-G
DUAL MALE BANJO

3700

PART NUMBER	TUBE OD	THREAD	PRICE EACH	
			1 - 9	10 +
CDPA06G01	6 mm	1/8" BSPP	£6.49	£5.84
CDPA08G02	8 mm	1/4" BSPP	£8.45	£7.60
CDPA10G02	10 mm	1/4" BSPP	£9.99	£8.99
CDPA10G03	10 mm	3/8" BSPP	£11.43	£10.29
CDPA12G03	12 mm	3/8" BSPP	£12.65	£11.38
CDPA12G04	12 mm	1/2" BSPP	£14.41	£12.97



PAF
DUAL FEMALE
STACKING BANJO

3700

PART NUMBER	TUBE OD	THREAD	PRICE EACH	
			1 - 9	10 +
CDPAF04M5	4 mm	M5 x 0.8	£7.00	£6.30
CDPAF0601	6 mm	1/8" BSPT	£7.72	£6.95
CDPAF0802	8 mm	1/4" BSPT	£9.69	£8.72
CDPAF1002	10 mm	1/4" BSPT	£11.87	£10.68
CDPAF1003	10 mm	3/8" BSPT	£13.18	£11.86
CDPAF1203	12 mm	3/8" BSPT	£14.46	£13.02
CDPAF1204	12 mm	1/2" BSPT	£16.07	£14.46



PAF-G
DUAL FEMALE
STACKING BANJO

3700

PART NUMBER	TUBE OD	THREAD	PRICE EACH	
			1 - 9	10 +
CDPAF06G01	6 mm	1/8" BSPP	£7.72	£6.95
CDPAF08G02	8 mm	1/4" BSPP	£9.69	£8.72
CDPAF10G02	10 mm	1/4" BSPP	£11.87	£10.68
CDPAF10G03	10 mm	3/8" BSPP	£13.18	£11.86
CDPAF12G03	12 mm	3/8" BSPP	£14.46	£13.02
CDPAF12G04	12 mm	1/2" BSPP	£16.07	£14.46

TUBE TO THREAD



PAT
DOUBLE BRANCH MALE BANJO

3700

PART NUMBER	TUBE OD	THREAD	PRICE EACH	
			1 - 9	10 +
CDPAT04012	4 mm	1/8" BSPT	£11.73	£10.55
CDPAT04022	4 mm	1/4" BSPT	£14.62	£13.16
CDPAT04032	4 mm	3/8" BSPT	£18.73	£16.86
CDPAT04042	4 mm	1/2" BSPT	£23.60	£21.24
CDPAT06012	6 mm	1/8" BSPT	£12.29	£11.06
CDPAT06022	6 mm	1/4" BSPT	£15.18	£13.66
CDPAT06032	6 mm	3/8" BSPT	£19.29	£17.36
CDPAT06042	6 mm	1/2" BSPT	£24.16	£21.74
CDPAT08012	8 mm	1/8" BSPT	£12.96	£11.67
CDPAT08022	8 mm	1/4" BSPT	£15.86	£14.27
CDPAT08032	8 mm	3/8" BSPT	£19.96	£17.97
CDPAT08042	8 mm	1/2" BSPT	£24.83	£22.35
CDPAT10022	10 mm	1/4" BSPT	£17.14	£15.42
CDPAT10032	10 mm	3/8" BSPT	£21.25	£19.12
CDPAT10042	10 mm	1/2" BSPT	£26.11	£23.50
CDPAT12022	12 mm	1/4" BSPT	£19.21	£17.29
CDPAT12032	12 mm	3/8" BSPT	£23.32	£20.99
CDPAT12042	12 mm	1/2" BSPT	£28.18	£25.36



PAT-G
DOUBLE BRANCH MALE BANJO

3700

PART NUMBER	TUBE OD	THREAD	PRICE EACH	
			1 - 9	10 +
CDPAT04G012	4 mm	1/8" BSPP	£11.73	£10.55
CDPAT04G022	4 mm	1/4" BSPP	£14.62	£13.16
CDPAT04G032	4 mm	3/8" BSPP	£18.73	£16.86
CDPAT04G042	4 mm	1/2" BSPP	£23.60	£21.24
CDPAT06G012	6 mm	1/8" BSPP	£12.29	£11.06
CDPAT06G022	6 mm	1/4" BSPP	£15.18	£13.66
CDPAT06G032	6 mm	3/8" BSPP	£19.29	£17.36
CDPAT06G042	6 mm	1/2" BSPP	£24.16	£21.74
CDPAT08G012	8 mm	1/8" BSPP	£12.96	£11.67
CDPAT08G022	8 mm	1/4" BSPP	£15.86	£14.27
CDPAT08G032	8 mm	3/8" BSPP	£19.96	£17.97
CDPAT08G042	8 mm	1/2" BSPP	£24.83	£22.35
CDPAT10G022	10 mm	1/4" BSPP	£17.14	£15.42
CDPAT10G032	10 mm	3/8" BSPP	£21.25	£19.12
CDPAT10G042	10 mm	1/2" BSPP	£26.11	£23.50
CDPAT12G022	12 mm	1/4" BSPP	£19.21	£17.29
CDPAT12G032	12 mm	3/8" BSPP	£23.32	£20.99
CDPAT12G042	12 mm	1/2" BSPP	£28.18	£25.36



PAT
TRIPLE BRANCH MALE BANJO

3700

PART NUMBER	TUBE OD	THREAD	PRICE EACH	
			1 - 9	10 +
CDPAT04013	4 mm	1/8" BSPT	£15.65	£14.08
CDPAT04023	4 mm	1/4" BSPT	£20.22	£18.20
CDPAT04033	4 mm	3/8" BSPT	£25.46	£22.91
CDPAT04043	4 mm	1/2" BSPT	£31.61	£28.45
CDPAT06013	6 mm	1/8" BSPT	£16.49	£14.84
CDPAT06023	6 mm	1/4" BSPT	£21.07	£18.96
CDPAT06033	6 mm	3/8" BSPT	£26.30	£23.67
CDPAT06043	6 mm	1/2" BSPT	£32.45	£29.21
CDPAT08013	8 mm	1/8" BSPT	£17.49	£15.74
CDPAT08023	8 mm	1/4" BSPT	£22.08	£19.87
CDPAT08033	8 mm	3/8" BSPT	£27.31	£24.58
CDPAT08043	8 mm	1/2" BSPT	£33.46	£30.11
CDPAT10023	10 mm	1/4" BSPT	£24.00	£21.60
CDPAT10033	10 mm	3/8" BSPT	£29.23	£26.31
CDPAT10043	10 mm	1/2" BSPT	£35.39	£31.85
CDPAT12023	12 mm	1/4" BSPT	£27.10	£24.39
CDPAT12033	12 mm	3/8" BSPT	£32.34	£29.11
CDPAT12043	12 mm	1/2" BSPT	£38.49	£34.64



PAT-G
TRIPLE BRANCH MALE BANJO

3700

PART NUMBER	TUBE OD	THREAD	PRICE EACH	
			1 - 9	10 +
CDPAT04G013	4 mm	1/8" BSPP	£15.65	£14.08
CDPAT04G023	4 mm	1/4" BSPP	£20.22	£18.20
CDPAT04G033	4 mm	3/8" BSPP	£25.46	£22.91
CDPAT04G043	4 mm	1/2" BSPP	£31.61	£28.45
CDPAT06G013	6 mm	1/8" BSPP	£16.49	£14.84
CDPAT06G023	6 mm	1/4" BSPP	£21.07	£18.96
CDPAT06G033	6 mm	3/8" BSPP	£26.30	£23.67
CDPAT06G043	6 mm	1/2" BSPP	£32.45	£29.21
CDPAT08G013	8 mm	1/8" BSPP	£17.49	£15.74
CDPAT08G023	8 mm	1/4" BSPP	£22.08	£19.87
CDPAT08G033	8 mm	3/8" BSPP	£27.31	£24.58
CDPAT08G043	8 mm	1/2" BSPP	£33.46	£30.11
CDPAT12G023	12 mm	1/4" BSPP	£27.10	£24.39
CDPAT12G033	12 mm	3/8" BSPP	£32.34	£29.11
CDPAT12G043	12 mm	1/2" BSPP	£38.49	£34.64

John Guest
Fittings also
available, see
section 12.



METRIC TUBE TO TUBE

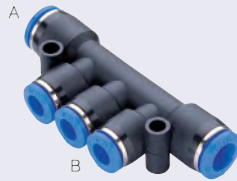

PKG
REDUCER
TRIPLE BRANCH UNION

3700

PART NUMBER	TUBE OD (A)	TUBE OD (B)	PRICE EACH	
			1 - 9	10 +
CDPKG0604N	6 mm	4 mm	£9.11	£8.20
CDPKG0804N	8 mm	4 mm	£9.52	£8.57
CDPKG0806N	8 mm	6 mm	£9.88	£8.90
CDPKG1006N	10 mm	6 mm	£10.62	£9.56
CDPKG1008N	10 mm	8 mm	£11.02	£9.92



PKJ
PLUG-IN REDUCER
TRIPLE BRANCH UNION

3700

PART NUMBER	TUBE OD (A)	TUBE OD (B)	STEM	PRICE EACH	
				1 - 9	10 +
CDPKJ0604N	6 mm	4 mm	6 mm	£11.05	£9.95
CDPKJ0804N	8 mm	4 mm	8 mm	£11.87	£10.68
CDPKJ0806N	8 mm	6 mm	8 mm	£12.76	£11.48
CDPKJ1006N	10 mm	6 mm	10 mm	£12.34	£11.11
CDPKJ1008N	10 mm	8 mm	10 mm	£13.27	£11.94



PP
PLUG

3700

PART NUMBER	TUBE OD	PRICE EACH	
		1 - 9	10 +
CDPP04N	4 mm	£0.84	£0.76
CDPP06N	6 mm	£0.84	£0.76
CDPP08N	8 mm	£0.94	£0.84
CDPP10N	10 mm	£1.10	£0.99
CDPP12N	12 mm	£1.25	£1.13
CDPP16N	16 mm	£3.05	£2.75



PXG
DOUBLE REDUCER 'Y'

3700

PART NUMBER	TUBE OD (A)	TUBE OD (B)	PRICE EACH	
			1 - 9	10 +
CDPXG0604N	6 mm	4 mm	£7.64	£6.88
CDPXG0806N	8 mm	6 mm	£10.30	£9.27



PLM
BULKHEAD UNION ELBOW

3700

PART NUMBER	TUBE OD	TUBE OD	PRICE EACH	
			1 - 9	10 +
CDPLM04N	4 mm	4 mm	£5.43	£4.89
CDPLM06N	6 mm	6 mm	£6.76	£6.08
CDPLM08N	8 mm	8 mm	£8.30	£7.47
CDPLM10N	10 mm	10 mm	£11.63	£10.46
CDPLM12N	12 mm	12 mm	£14.60	£13.14



PMP
BULKHEAD UNION

3700

PART NUMBER	TUBE OD	TUBE OD	PRICE EACH	
			1 - 9	10 +
CDPMP04N	4 mm	4 mm	£2.98	£2.68
CDPMP06N	6 mm	6 mm	£3.07	£2.76
CDPMP08N	8 mm	8 mm	£3.21	£2.89
CDPMP10N	10 mm	10 mm	£4.15	£3.74
CDPMP12N	12 mm	12 mm	£4.51	£4.06



CAS
CARTRIDGE

3700

PART NUMBER	TUBE OD	HOLE OD	PRICE EACH	
			1 - 9	10 +
CDCAS04	4 mm	8.95 mm	£1.46	£1.31
CDCAS06	6 mm	11.10 mm	£1.54	£1.39
CDCAS08	8 mm	13.20 mm	£1.67	£1.51
CDCAS10	10 mm	15.45 mm	£1.93	£1.73
CDCAS12	12 mm	17.75 mm	£2.31	£2.08

METRIC TUBE TO TUBE

PLJ
PLUG-IN ELBOW



3700

PART NUMBER	STEM OD	TUBE OD	PRICE EACH	
			1 - 9	10 +
CDPLJ04N	4 mm	4 mm	£2.78	£2.50
CDPLJ06N	6 mm	6 mm	£3.07	£2.76
CDPLJ08N	8 mm	8 mm	£3.42	£3.07
CDPLJ10N	10 mm	10 mm	£3.79	£3.41
CDPLJ12N	12 mm	12 mm	£4.96	£4.46
CDPLJ16N	16 mm	16 mm	£3.93	£3.53

PGJ
PLUG-IN REDUCER



3700

PART NUMBER	STEM OD (B)	TUBE OD (A)	PRICE EACH	
			1 - 9	10 +
CDPGJ0406N	4 mm	6 mm	£1.44	£1.30
CDPGJ0604N	6 mm	4 mm	£1.44	£1.30
CDPGJ0608N	6 mm	8 mm	£1.62	£1.46
CDPGJ0804N	8 mm	4 mm	£1.44	£1.30
CDPGJ0806N	8 mm	6 mm	£1.62	£1.46
CDPGJ1006N	10 mm	6 mm	£1.62	£1.46
CDPGJ1008N	10 mm	8 mm	£1.81	£1.63
CDPGJ1206N	12 mm	6 mm	£2.04	£1.84
CDPGJ1208N	12 mm	8 mm	£2.06	£1.85
CDPGJ1210N	12 mm	10 mm	£2.12	£1.91

PYJ
PLUG-IN 'Y'



3700

PART NUMBER	STEM OD	TUBE OD	PRICE EACH	
			1 - 9	10 +
CDPYJ04N	4 mm	4 mm	£4.73	£4.25
CDPYJ06N	6 mm	6 mm	£5.21	£4.69
CDPYJ08N	8 mm	8 mm	£5.80	£5.22
CDPYJ10N	10 mm	10 mm	£6.44	£5.80
CDPYJ12N	12 mm	12 mm	£7.47	£6.72

PWJ
PLUG-IN REDUCER 'Y'



3700

PART NUMBER	STEM OD (B)	TUBE OD (A)	PRICE EACH	
			1 - 9	10 +
CDPWJ0604N	6 mm	4 mm	£5.24	£4.71
CDPWJ0806N	8 mm	6 mm	£5.75	£5.18
CDPWJ1008N	10 mm	8 mm	£6.37	£5.73
CDPWJ1210N	12 mm	10 mm	£7.48	£6.73

PIJ
TUBE SPLICER



3700

PART NUMBER	STEM OD	PRICE EACH	
		1 - 9	10 +
CDPIJ04	4 mm	£1.07	£0.96
CDPIJ06	6 mm	£1.25	£1.13
CDPIJ08	8 mm	£1.44	£1.29
CDPIJ10	10 mm	£1.57	£1.41
CDPIJ12	12 mm	£2.02	£1.81
CDPIJ16	16 mm	£2.93	£2.63

PIG
REDUCER TUBE SPLICER



3700

PART NUMBER	STEM OD (A)	STEM OD (B)	PRICE EACH	
			1 - 9	10 +
CDPIG0604	6 mm	4 mm	£1.46	£1.31
CDPIG0804	8 mm	4 mm	£1.58	£1.42
CDPIG0806	8 mm	6 mm	£1.57	£1.41
CDPIG1006	10 mm	6 mm	£1.62	£1.46
CDPIG1008	10 mm	8 mm	£1.62	£1.46
CDPIG1208	12 mm	8 mm	£1.83	£1.65
CDPIG1210	12 mm	10 mm	£1.83	£1.64
CDPIG1612	16 mm	12 mm	£3.46	£3.11

PSJ
PLUG-IN RUN TEE



3700

PART NUMBER	STEM OD (A)	TUBE OD (B)	PRICE EACH	
			1 - 9	10 +
CDPSJ04N	4 mm	4 mm	£2.78	£2.50
CDPSJ0604N	6 mm	4 mm	£3.07	£2.76
CDPSJ06N	6 mm	6 mm	£3.07	£2.76
CDPSJ0806N	8 mm	6 mm	£3.42	£3.07
CDPSJ08N	8 mm	8 mm	£3.42	£3.07
CDPSJ1008N	10 mm	8 mm	£3.79	£3.41
CDPSJ10N	10 mm	10 mm	£3.79	£3.41
CDPSJ1210N	12 mm	10 mm	£4.96	£4.46
CDPSJ12N	12 mm	12 mm	£4.96	£4.46

PTJ
PLUG-IN BRANCH TEE



3700

PART NUMBER	STEM OD (A)	TUBE OD (B)	PRICE EACH	
			1 - 9	10 +
CDPTJ04N	4 mm	4 mm	£2.78	£2.50
CDPTJ0604N	6 mm	4 mm	£3.07	£2.76
CDPTJ06N	6 mm	6 mm	£3.07	£2.76
CDPTJ0806N	8 mm	6 mm	£3.42	£3.07
CDPTJ08N	8 mm	8 mm	£3.42	£3.07
CDPTJ1008N	10 mm	8 mm	£3.79	£3.41
CDPTJ10N	10 mm	10 mm	£3.79	£3.41
CDPTJ1210N	12 mm	10 mm	£4.96	£4.46
CDPTJ12N	12 mm	12 mm	£4.96	£4.46

PUSH-IN FITTING KITS

FEATURES

- One touch, push-to-connect configuration allows instant tubing connection
- PC type has internal / external hexagonal shapes for efficient piping in limited spaces
- Main body of PL and PT types is a rotating structure for efficient piping
- The section has an O-ring or Teflon coating

APPLICATIONS

- One touch type pipe connection tool for air pressure piping
- Various uses depending on the user's environment

SPECIFICATIONS

Fluid type	Air (No other type of gas or liquid)
Working pressure	0 to 150 psi (10.2 bar)
Negative pressure	-29.5 in Hg / -750 mm Hg (-750 Torr)
Working temperature	0°C to +60°C (+32°F to +140°F)
Application tube	Polyurethane and nylon



New

4 MM KIT

3700

PART NUMBER	DESCRIPTION	PRICE
KIT-CDC04	4 mm push-in fitting kit	£130.34

4 MM KIT CONTENTS

PART NUMBER	DESCRIPTION	QTY
CDPIJ04	4 mm Tube Splicer	3
CDPP04N	4 mm Tube Plug	3
D-TC14	Tube Cutter	1
CDPPF04N	4 mm Tube Cap	3
CDPUT04N	4 mm Equal Tee Connector	5
CDPY04N	4 mm Equal 'Y' Connector	5
CDPG0604N	6 mm x 4 mm Reducer	3
CDPUL04N	4 mm Equal Elbow Connector	5
CDPUC04N	4 mm Equal Straight Connector	5
CDPL0401N	Rotating Male Elbow 4 mm x 1/8" BSPT	5
CDPL0402N	Rotating Male Elbow 4 mm x 1/4" BSPT	5
CDPC0401N	Male Stud Coupling 4 mm x 1/8" BSPT	5
CDPC0402N	Male Stud Coupling 4 mm x 1/4" BSPT	5

New

6 MM KIT

3700

PART NUMBER	DESCRIPTION	PRICE
KIT-CDC06	6 mm push-in fitting kit	£153.79

6 MM KIT CONTENTS

PART NUMBER	DESCRIPTION	QTY
CDPIJ06	6 mm Tube Splicer	5
CDPP06N	6 mm Tube Plug	3
D-TC14	Tube Cutter	1
CDPPF06N	6 mm Tube Cap	3
CDPUT06N	6 mm Equal Tee Connector	5
CDPY06N	6 mm Equal 'Y' Connector	5
CDPG0604N	6 mm x 4 mm Reducer	3
CDPG0806N	8 mm x 6 mm Reducer	3
CDPUL06N	6 mm Equal Elbow Connector	5
CDPUC06N	6 mm Equal Straight Connector	5
CDPL0601N	6 mm x 1/8" BSPT Rotating Male Elbow	5
CDPL0602N	6 mm x 1/4" BSPT Rotating Male Elbow	5
CDPC0601N	6 mm x 1/8" BSPT Male Stud Coupling	5
CDPC0602N	6 mm x 1/4" BSPT Male Stud Coupling	5
CDHVU0606	6 mm HVU Straight Valve	1

New

8 MM KIT

3700

PART NUMBER	DESCRIPTION	PRICE
KIT-CDC08	8 mm push-in fitting kit	£168.91

8 MM KIT CONTENTS

PART NUMBER	DESCRIPTION	QTY
CDPIJ08	8 mm Tube Splicer	5
CDPP08N	8 mm Tube Plug	3
D-TC14	Tube Cutter	1
CDPPF08N	8 mm Tube Cap	3
CDPUT08N	8 mm Equal Tee Connector	5
CDPY08N	8 mm Equal 'Y' Connector	5
CDPG0806N	8 mm x 6 mm Reducer	3
CDPG1008N	10 mm x 8 mm Reducer	3
CDPUL08N	8 mm Equal Elbow Connector	5
CDPUC08N	8 mm Equal Straight Connector	5
CDPL0802N	8 mm x 1/4" BSPT Rotating Male Elbow	5
CDPL0803N	8 mm x 3/8" BSPT Rotating Male Elbow	5
CDPC0802N	8 mm x 1/4" BSPT Male Stud Coupling	5
CDPC0803N	8 mm x 3/8" BSPT Male Stud Coupling	5
CDHVU0808	8 mm HVU Straight Valve	1

New

10 MM KIT

3700

PART NUMBER	DESCRIPTION	PRICE
KIT-CDC10	10 mm push-in fitting kit	£189.21

10 MM KIT CONTENTS

PART NUMBER	DESCRIPTION	QTY
CDPIJ10	10 mm Tube Splicer	5
CDPP10N	10 mm Tube Plug	3
D-TC14	Tube Cutter	1
CDPPF10N	10 mm Tube Cap	3
CDPY10N	10 mm Equal 'Y' Connector	5
CDPG1008N	10 mm x 8 mm Reducer	3
CDPUL10N	10 mm Equal Elbow Connector	5
CDPUT10N	10 mm Equal Tee Connector	3
CDPUC10N	10 mm Equal Straight Connector	5
CDPL1002N	10 mm x 1/4" BSPT Rotating Male Elbow	5
CDPL1003N	10 mm x 3/8" BSPT Rotating Male Elbow	5
CDPC1002N	10 mm x 1/4" BSPT Male Stud Coupling	5
CDPC1003N	10 mm x 3/8" BSPT Male Stud Coupling	5
CDHVU1010	10 mm HVU Straight Valve	1

New

12 MM KIT

3700

PART NUMBER	DESCRIPTION	PRICE
KIT-CDC12	12 mm push-in fitting kit	£203.00

12 MM KIT CONTENTS

PART NUMBER	DESCRIPTION	QTY
CDPIJ12	12 mm Tube Splicer	5
CDPP12N	12 mm Tube Plug	3
D-TC14	Tube Cutter	1
CDPPF12N	12 mm Tube Cap	3
CDPUT12N	12 mm Equal Tee Connector	3
CDPY12N	12 mm Equal 'Y' Connector	3
CDPG1210N	12 mm x 10 mm Reducer	3
CDPUL12N	12 mm Equal Elbow Connector	5
CDPUC12N	12 mm Equal Straight Connector	5
CDPL1203N	12 mm x 3/8" BSPT Rotating Male Elbow	5
CDPL1204N	12 mm x 1/2" BSPT Rotating Male Elbow	5
CDPC1203N	12 mm x 3/8" BSPT Male Stud Coupling	5
CDPC1204N	12 mm x 1/2" BSPT Male Stud Coupling	5
CDHVU1212	12 mm HVU Straight Valve	1

IMPERIAL TUBE TO TUBE

PUC
EQUAL STRAIGHT UNION



3700

PART NUMBER	TUBE OD	PRICE EACH	
		1 - 9	10 +
CDPUC5/32	5/32"	£2.30	£2.07
CDPUC3/16	3/16"	£2.53	£2.27
CDPUC1/4	1/4"	£2.53	£2.27
CDPUC5/16	5/16"	£2.65	£2.38
CDPUC3/8	3/8"	£2.98	£2.68
CDPUC1/2	1/2"	£4.02	£3.62

PGT
REDUCER TEE



3700

PART NUMBER	TUBE OD (A)	TUBE OD (B)	PRICE EACH	
			1 - 9	10 +
CDPGT1/45/32	1/4"	5/32"	£3.55	£3.19
CDPGT5/161/4	5/16"	1/4"	£3.65	£3.29
CDPGT3/81/4	3/8"	1/4"	£3.79	£3.41
CDPGT3/8516	3/8"	5/16"	£3.86	£3.47
CDPGT1/23/8	1/2"	3/8"	£5.42	£4.88

PUL
EQUAL UNION ELBOW



3700

PART NUMBER	TUBE OD	PRICE EACH	
		1 - 9	10 +
CDPUL5/32	5/32"	£2.41	£2.17
CDPUL3/16	3/16"	£2.53	£2.27
CDPUL1/4	1/4"	£2.53	£2.27
CDPUL5/16	5/16"	£2.65	£2.38
CDPUL3/8	3/8"	£2.98	£2.68
CDPUL1/2	1/2"	£4.02	£3.62

PZA
UNION CROSS



3700

PART NUMBER	TUBE OD	TUBE OD	PRICE EACH	
			1 - 9	10 +
CDPZA5/32	5/32"	5/32"	£5.68	£5.12
CDPZA3/16	3/16"	3/16"	£6.33	£5.70
CDPZA1/4	1/4"	1/4"	£6.33	£5.70
CDPZA5/16	5/16"	5/16"	£6.50	£5.85
CDPZA3/8	3/8"	3/8"	£7.46	£6.71
CDPZA1/2	1/2"	1/2"	£7.91	£7.12

PUT
EQUAL UNION TEE



3700

PART NUMBER	TUBE OD	PRICE EACH	
		1 - 9	10 +
CDPUT5/32	5/32"	£3.90	£3.51
CDPUT3/16	3/16"	£3.90	£3.51
CDPUT1/4	1/4"	£3.90	£3.51
CDPUT5/16	5/16"	£4.02	£3.62
CDPUT3/8	3/8"	£4.25	£3.82
CDPUT1/2	1/2"	£5.96	£5.37

PMM
BULKHEAD UNION



3700

PART NUMBER	TUBE OD	TUBE OD	PRICE EACH	
			1 - 9	10 +
CDPMM5/32N	5/32"	5/32"	£4.30	£3.87
CDPMM3/16N	3/16"	3/16"	£5.40	£4.86
CDPMM1/4N	1/4"	1/4"	£5.40	£4.86
CDPMM5/16N	5/16"	5/16"	£6.50	£5.85
CDPMM3/8N	3/8"	3/8"	£9.28	£8.35
CDPMM1/2N	1/2"	1/2"	£12.66	£11.39

PG
REDUCER



3700

PART NUMBER	TUBE OD	TUBE OD	PRICE EACH	
			1 - 9	10 +
CDPG3/165/32	3/16"	5/32"	£2.56	£2.30
CDPG1/45/32	1/4"	5/32"	£2.56	£2.30
CDPG1/43/16	1/4"	3/16"	£2.56	£2.30
CDPG5/161/4	5/16"	1/4"	£2.79	£2.51
CDPG3/81/4	3/8"	1/4"	£3.70	£3.33
CDPG3/85/16	3/8"	5/16"	£3.70	£3.33
CDPG1/23/8	1/2"	3/8"	£3.86	£3.47

PPF
CAP



3700

PART NUMBER	TUBE OD	PRICE EACH	
		1 - 9	10 +
CDPPF5/32	5/32"	£1.74	£1.57
CDPPF3/16	3/16"	£1.91	£1.72
CDPPF1/4	1/4"	£1.91	£1.72
CDPPF5/16	5/16"	£2.08	£1.87
CDPPF3/8	3/8"	£2.52	£2.27
CDPPF1/2	1/2"	£2.77	£2.49

PY
EQUAL UNION 'Y'



3700

PART NUMBER	TUBE OD	PRICE EACH	
		1 - 9	10 +
CDPY5/32	5/32"	£4.77	£4.30
CDPY3/16	3/16"	£4.77	£4.30
CDPY1/4	1/4"	£4.77	£4.30
CDPY5/16	5/16"	£5.30	£4.77
CDPY3/8	3/8"	£6.59	£5.93
CDPY1/2	1/2"	£6.00	£5.40

PW
REDUCER 'Y'



3700

PART NUMBER	TUBE OD (A)	TUBE OD (B)	PRICE EACH	
			1 - 9	10 +
CDPW3/165/32	3/16"	5/32"	£3.65	£3.29
CDPW1/45/32	1/4"	5/32"	£3.65	£3.29
CDPW1/43/16	1/4"	3/16"	£3.65	£3.29
CDPW5/161/4	5/16"	1/4"	£3.82	£3.44
CDPW3/81/4	3/8"	1/4"	£4.42	£3.98
CDPW3/85/16	3/8"	5/16"	£4.42	£3.98
CDPW1/23/8	1/2"	3/8"	£6.49	£5.84

IMPERIAL TO THREAD BSPT

**PC
MALE STRAIGHT**

3700

PART NUMBER	TUBE OD	THREAD	PRICE EACH	
			1 - 9	10 +
CDPC1/401	1/4"	1/8" BSPT	£2.15	£1.93
CDPC1/402	1/4"	1/4" BSPT	£2.27	£2.04
CDPC1/403	1/4"	3/8" BSPT	£2.84	£2.56
CDPC3/801	3/8"	1/8" BSPT	£3.15	£2.84
CDPC3/802	3/8"	1/4" BSPT	£3.08	£2.77
CDPC3/803	3/8"	3/8" BSPT	£3.10	£2.79
CDPC3/804	3/8"	1/2" BSPT	£3.86	£3.47
CDPC1/202	1/2"	1/4" BSPT	£3.88	£3.49
CDPC1/203	1/2"	3/8" BSPT	£4.00	£3.60
CDPC1/204	1/2"	1/2" BSPT	£4.51	£4.06

**PL – SWIVEL ROTATING
MALE ELBOW**

3700

PART NUMBER	TUBE OD	THREAD	PRICE EACH	
			1 - 9	10 +
CDPL1/401	1/4"	1/8" BSPT	£2.71	£2.44
CDPL1/402	1/4"	1/4" BSPT	£2.91	£2.61
CDPL1/403	1/4"	3/8" BSPT	£3.41	£3.07
CDPL3/801	3/8"	1/8" BSPT	£4.35	£3.91
CDPL3/802	3/8"	1/4" BSPT	£4.39	£3.95
CDPL3/803	3/8"	3/8" BSPT	£4.40	£3.96
CDPL3/804	3/8"	1/2" BSPT	£5.28	£4.75
CDPL1/202	1/2"	1/4" BSPT	£5.29	£4.76
CDPL1/203	1/2"	3/8" BSPT	£5.47	£4.92
CDPL1/204	1/2"	1/2" BSPT	£5.75	£5.18

**PCF
FEMALE STRAIGHT**

3700

PART NUMBER	TUBE OD	THREAD	PRICE EACH	
			1 - 9	10 +
CDPCF1/401	1/4"	1/8" BSPT	£3.19	£2.87
CDPCF1/402	1/4"	1/4" BSPT	£3.47	£3.12
CDPCF3/802	3/8"	1/4" BSPT	£4.59	£4.13
CDPCF3/803	3/8"	3/8" BSPT	£5.78	£5.20

**PT – SWIVEL ROTATING
MALE BRANCH TEE**

3700

PART NUMBER	TUBE OD	THREAD	PRICE EACH	
			1 - 9	10 +
CDPT1/401	1/4"	1/8" BSPT	£4.02	£3.62
CDPT1/402	1/4"	1/4" BSPT	£4.21	£3.79
CDPT1/403	1/4"	3/8" BSPT	£4.91	£4.42
CDPT3/801	3/8"	1/8" BSPT	£5.73	£5.16
CDPT3/802	3/8"	1/4" BSPT	£5.85	£5.26
CDPT3/803	3/8"	3/8" BSPT	£6.16	£5.54
CDPT3/804	3/8"	1/2" BSPT	£6.78	£6.10
CDPT1/202	1/2"	1/4" BSPT	£6.76	£6.08
CDPT1/203	1/2"	3/8" BSPT	£6.92	£6.22
CDPT1/204	1/2"	1/2" BSPT	£7.22	£6.50

IMPERIAL TUBE TO THREAD NPT

**PC-NPT
MALE STRAIGHT**

3700

PART NUMBER	TUBE OD	THREAD	PRICE EACH	
			1 - 9	10 +
CDPC1/4N02	1/4"	1/4" NPT	£2.27	£2.04
CDPC3/8N03	3/8"	3/8" NPT	£3.10	£2.79
CDPC1/2N04	1/2"	1/2" NPT	£4.51	£4.06

**PCF-NPT
FEMALE STRAIGHT**

3700

PART NUMBER	TUBE OD	THREAD	PRICE EACH	
			1 - 9	10 +
CDPCF1/4N02	1/4"	1/4" NPT	£3.47	£3.12
CDPCF3/8N03	3/8"	3/8" NPT	£5.78	£5.20

**PL-NPT – SWIVEL ROTATING
MALE ELBOW**

3700

PART NUMBER	TUBE OD	THREAD	PRICE EACH	
			1 - 9	10 +
CDPL1/4N02	1/4"	1/4" NPT	£2.91	£2.61
CDPL3/8N03	3/8"	3/8" NPT	£4.40	£3.96
CDPL1/2N04	1/2"	1/2" NPT	£5.75	£5.18

**PT-NPT – SWIVEL ROTATING
MALE BRANCH TEE**

3700

PART NUMBER	TUBE OD	THREAD	PRICE EACH	
			1 - 9	10 +
CDPT1/4N02	1/4"	1/4" NPT	£4.02	£3.62
CDPT3/8N03	3/8"	3/8" NPT	£6.16	£5.54
CDPT1/2N04	1/2"	1/2" NPT	£7.22	£6.50

FEATURES

- One touch, push-to-connect configuration allows instant tubing connection
- Volume and OD are smaller than regular type, but same flux is obtained
- Electroless nickel coated surfaces for excellent tolerance to corrosion
- Oval sleeve is designed to allow easy release in limited spaces
- The screw section has an O-ring and Teflon coating
- Miniaturised fittings for small devices and piping in limited spaces

APPLICATIONS

- Mini one touch type pipe connection tool for air pressure piping in limited spaces
- Various uses depending on the user's environment

SPECIFICATIONS

Fluid type	Air (No other type of gas or liquid)
Working pressure	0 to 150 psi (10.2 bar)
Negative pressure	-29.5 in Hg -750 mm Hg (-750 Torr)
Working temperature	0°C to +60°C (+32°F to +140°F)
Application tube	Polyurethane and nylon

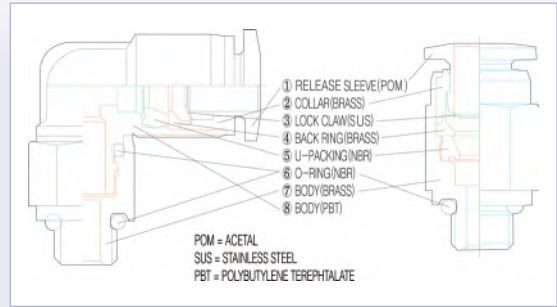

METRIC TUBE TO THREAD



PC-C
MALE STRAIGHT

3700

PART NUMBER	TUBE OD	THREAD	PRICE EACH	
			1 - 9	10 +
CDPC-C03M3	3 mm	M3 x 0.5	£2.18	£1.96
CDPC-C03M5	3 mm	M5 x 0.8	£2.28	£2.05
CDPC-C03M6	3 mm	M6 x 1.0	£2.28	£2.05
CDPC-C04M3	4 mm	M3 x 0.5	£2.11	£1.90
CDPC-C04M5	4 mm	M5 x 0.8	£2.11	£1.90
CDPC-C04M6	4 mm	M6 x 1.0	£2.32	£2.09
CDPC-C0401	4 mm	1/8" BSPT	£2.03	£1.83
CDPC-C06M5	6 mm	M5 x 0.8	£2.56	£2.31
CDPC-C06M6	6 mm	M6 x 1.0	£2.57	£2.31
CDPC-C0601	6 mm	1/8" BSPT	£2.17	£1.95



PCF-C
FEMALE STRAIGHT

3700

PART NUMBER	TUBE OD	THREAD	PRICE EACH	
			1 - 9	10 +
CDPCF-C03M3	3 mm	M3 x 0.5	£3.86	£3.48
CDPCF-C03M5	3 mm	M5 x 0.8	£3.86	£3.48
CDPCF-C03M6	3 mm	M6 x 1.0	£3.88	£3.49
CDPCF-C04M3	4 mm	M3 x 0.5	£3.89	£3.50
CDPCF-C04M5	4 mm	M5 x 0.8	£3.89	£3.50
CDPCF-C04M6	4 mm	M6 x 1.0	£3.89	£3.50
CDPCF-C0401	4 mm	1/8" BSPT	£2.88	£2.59
CDPCF-C06M5	6 mm	M5 x 0.8	£3.98	£3.58
CDPCF-C06M6	6 mm	M6 x 1.0	£4.00	£3.60
CDPCF-C0601	6 mm	1/8" BSPT	£3.19	£2.87



POC-C
ROUND MALE STRAIGHT

3700

PART NUMBER	TUBE OD	THREAD	PRICE EACH	
			1 - 9	10 +
CDPOC-C03M3	3 mm	M3 x 0.5	£3.41	£3.07
CDPOC-C03M5	3 mm	M5 x 0.8	£3.41	£3.07
CDPOC-C03M6	3 mm	M6 x 1.0	£3.42	£3.07
CDPOC-C04M3	4 mm	M3 x 0.5	£3.42	£3.08
CDPOC-C04M5	4 mm	M5 x 0.8	£3.42	£3.08
CDPOC-C04M6	4 mm	M6 x 1.0	£3.44	£3.09
CDPOC-C0401	4 mm	1/8" BSPT	£2.53	£2.28
CDPOC-C06M5	6 mm	M5 x 0.8	£3.51	£3.16
CDPOC-C06M6	6 mm	M6 x 1.0	£3.53	£3.18
CDPOC-C0601	6 mm	1/8" BSPT	£2.81	£2.53



PL-C – SWIVEL ROTATING
MALE ELBOW

3700

PART NUMBER	TUBE OD	THREAD	PRICE EACH	
			1 - 9	10 +
CDPL-C03M3	3 mm	M3 x 0.5	£3.51	£3.16
CDPL-C03M5	3 mm	M5 x 0.8	£3.51	£3.16
CDPL-C03M6	3 mm	M6 x 1.0	£3.53	£3.18
CDPL-C04M3	4 mm	M3 x 0.5	£3.53	£3.18
CDPL-C04M5	4 mm	M5 x 0.8	£3.53	£3.18
CDPL-C04M6	4 mm	M6 x 1.0	£3.54	£3.19
CDPL-C0401	4 mm	1/8" BSPT	£2.62	£2.36
CDPL-C06M5	6 mm	M5 x 0.8	£3.63	£3.26
CDPL-C06M6	6 mm	M6 x 1.0	£3.63	£3.27
CDPL-C0601	6 mm	1/8" BSPT	£2.91	£2.61

METRIC TUBE TO THREAD
**PLL-C – SWIVEL ROTATING
EXTENDED MALE ELBOW**

3700

PART NUMBER	TUBE OD	THREAD	PRICE EACH	
			1 - 9	10 +
CDPLL-C03M3	3 mm	M3 x 0.5	£6.44	£5.80
CDPLL-C03M5	3 mm	M5 x 0.8	£5.44	£4.90
CDPLL-C03M6	3 mm	M6 x 1.0	£5.44	£4.90
CDPLL-C04M3	4 mm	M3 x 0.5	£6.59	£5.93
CDPLL-C04M5	4 mm	M5 x 0.8	£4.29	£3.86
CDPLL-C04M6	4 mm	M6 x 1.0	£4.37	£3.93
CDPLL-C0401	4 mm	1/8" BSPT	£3.98	£3.58
CDPLL-C06M5	6 mm	M5 x 0.8	£4.60	£4.14
CDPLL-C06M6	6 mm	M6 x 1.0	£4.75	£4.28
CDPLL-C0601	6 mm	1/8" BSPT	£4.45	£4.00

**PST-C – SWIVEL ROTATING
MALE RUN TEE**

3700

PART NUMBER	TUBE OD	THREAD	PRICE EACH	
			1 - 9	10 +
CDPST-C03M3	3 mm	M3 x 0.5	£4.80	£4.32
CDPST-C03M5	3 mm	M5 x 0.8	£4.80	£4.32
CDPST-C03M6	3 mm	M6 x 1.0	£4.82	£4.33
CDPST-C04M3	4 mm	M3 x 0.5	£4.87	£4.38
CDPST-C04M5	4 mm	M5 x 0.8	£4.87	£4.38
CDPST-C04M6	4 mm	M6 x 1.0	£4.88	£4.39
CDPST-C0401	4 mm	1/8" BSPT	£4.15	£3.74
CDPST-C06M5	6 mm	M5 x 0.8	£5.08	£4.57
CDPST-C06M6	6 mm	M6 x 1.0	£5.08	£4.57
CDPST-C0601	6 mm	1/8" BSPT	£4.27	£3.84

**PT-C – SWIVEL ROTATING
MALE BRANCH TEE**

3700

PART NUMBER	TUBE OD	THREAD	PRICE EACH	
			1 - 9	10 +
CDPT-C03M3	3 mm	M3 x 0.5	£4.46	£4.01
CDPT-C03M5	3 mm	M5 x 0.8	£4.46	£4.01
CDPT-C03M6	3 mm	M6 x 1.0	£4.47	£4.02
CDPT-C04M3	4 mm	M3 x 0.5	£4.51	£4.06
CDPT-C04M5	4 mm	M5 x 0.8	£4.51	£4.06
CDPT-C04M6	4 mm	M6 x 1.0	£4.52	£4.07
CDPT-C0401	4 mm	1/8" BSPT	£3.84	£3.46
CDPT-C06M5	6 mm	M5 x 0.8	£4.70	£4.23
CDPT-C06M6	6 mm	M6 x 1.0	£4.71	£4.24
CDPT-C0601	6 mm	1/8" BSPT	£3.96	£3.56

**PL-G-C – SWIVEL ROTATING
MALE ELBOW**

3700

PART NUMBER	TUBE OD	THREAD	PRICE EACH	
			1 - 9	10 +
CDPL-C04G01	4 mm	1/8"	£2.35	£2.12
CDPL-C06G01	6 mm	1/8"	£2.91	£2.61

**PC-G-C
MALE STRAIGHT**

3700

PART NUMBER	TUBE OD	THREAD	PRICE EACH	
			1 - 9	10 +
CDPC-C04G01	4 mm	1/8"	£2.03	£1.83
CDPC-C06G01	6 mm	1/8"	£2.16	£1.95

For E.MC Pneumatic
Products, see
section 6.

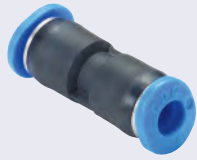
METRIC TUBE TO TUBE

**PUC-C
STRAIGHT UNION**

3700

PART NUMBER	TUBE OD	PRICE EACH	
		1 - 9	10 +
CDPUC-C03	3 mm	£2.21	£1.99
CDPUC-C04	4 mm	£2.28	£2.05
CDPUC-C06	6 mm	£2.51	£2.26

**PMM-C
BULKHEAD UNION**

3700

PART NUMBER	TUBE OD	PRICE EACH	
		1 - 9	10 +
CDPMM-C03	3 mm	£4.10	£3.69
CDPMM-C04	4 mm	£4.43	£3.99
CDPMM-C06	6 mm	£4.92	£4.43

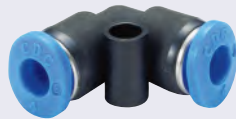
**PUL-C
UNION ELBOW**

3700

PART NUMBER	TUBE OD	PRICE EACH	
		1 - 9	10 +
CDPUL-C03	3 mm	£2.21	£1.99
CDPUL-C04	4 mm	£2.28	£2.05
CDPUL-C06	6 mm	£2.51	£2.26

**PUT-C
UNION TEE**

3700

PART NUMBER	TUBE OD	PRICE EACH	
		1 - 9	10 +
CDPUT-C03	3 mm	£3.45	£3.11
CDPUT-C04	4 mm	£3.56	£3.20
CDPUT-C06	6 mm	£3.96	£3.57

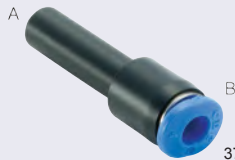
**PGJ-C
PLUG-IN REDUCER**

3700

PART NUMBER	TUBE OD (A)	TUBE OD (B)	PRICE EACH	
			1 - 9	10 +
CDPGJ-C0403	4 mm	3 mm	£3.45	£3.11
CDPGJ-C0603	6 mm	3 mm	£3.75	£3.38
CDPGJ-C0604	6 mm	4 mm	£3.91	£3.52

**PG-C
REDUCER**

3700

PART NUMBER	TUBE OD (A)	TUBE OD (B)	PRICE EACH	
			1 - 9	10 +
CDPG-C0403	4 mm	3 mm	£2.32	£2.09
CDPG-C0603	6 mm	3 mm	£2.38	£2.14
CDPG-C0604	6 mm	4 mm	£2.63	£2.37

**PY-C
UNION 'Y'**

3700

PART NUMBER	TUBE OD	PRICE EACH	
		1 - 9	10 +
CDPY-C03	3 mm	£3.53	£3.18
CDPY-C04	4 mm	£4.21	£3.79
CDPY-C06	6 mm	£4.45	£4.00

**PW-C
REDUCER 'Y'**

3700

PART NUMBER	TUBE OD (A)	TUBE OD (B)	PRICE EACH	
			1 - 9	10 +
CDPW-C0403	4 mm	3 mm	£4.21	£3.79
CDPW-C0603	6 mm	3 mm	£4.60	£4.14
CDPW-C0604	6 mm	4 mm	£4.83	£4.35

**PP-C
PLUG**

3700

PART NUMBER	TUBE OD	PRICE EACH	
		1 - 9	10 +
CDPP-C03	3 mm	£1.75	£1.58

FEATURES

- Accurate regulation of an optimal airflow rate for precise motion control
- Tube direction and angle are controlled according to piping, as the main body can rotate up to 360° after assembly
- Needle rotation is increased to 10-12 times for easy speed and regular speed control
- Easy speed control with drive tools in limited and crowded spaces NSC (D) and NSC (DC) types
- Miniaturised products occupy small space attaching to devices

APPLICATIONS

- A valve to control the speed of the air pressure actuator
- Mainly installed in the air actuator

SPECIFICATIONS

Fluid type	Air (No other type of gas or liquid)
Working pressure	0 to 150 psi (10.2 bar)
Negative pressure	-29.5 in Hg -750 mm Hg (-750 Torr)
Working temperature	0°C to +60°C (+32°F to +140°F)

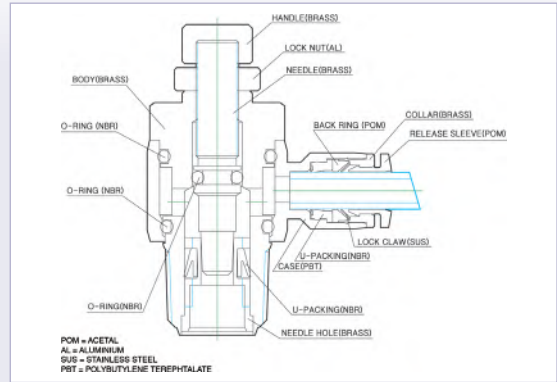

METRIC TUBE TO THREAD



NSC – SWIVEL ROTATING ELBOW

3700



NSC-G – SWIVEL ROTATING ELBOW

3700

PART NUMBER	TUBE OD	THREAD	PRICE EACH	
			1 - 9	10 +
CDNSC03M5N	3 mm	M5 x 0.8	£8.04	£7.24
CDNSC04M5N	4 mm	M5 x 0.8	£8.33	£7.50
CDNSC0401N	4 mm	1/8" BSPT	£9.54	£8.59
CDNSC0402N	4 mm	1/4" BSPT	£10.00	£9.00
CDNSC06M5N	6 mm	M5 x 0.8	£8.34	£7.51
CDNSC0601N	6 mm	1/8" BSPT	£9.63	£8.66
CDNSC0602N	6 mm	1/4" BSPT	£9.98	£8.98
CDNSC0603N	6 mm	3/8" BSPT	£12.43	£11.19
CDNSC0604N	6 mm	1/2" BSPT	£17.84	£16.05
CDNSC0801N	8 mm	1/8" BSPT	£10.30	£9.27
CDNSC0802N	8 mm	1/4" BSPT	£10.32	£9.29
CDNSC0803N	8 mm	3/8" BSPT	£12.41	£11.17
CDNSC0804N	8 mm	1/2" BSPT	£17.15	£15.44
CDNSC1001N	10 mm	1/8" BSPT	£11.42	£10.28
CDNSC1002N	10 mm	1/4" BSPT	£12.78	£11.50
CDNSC1003N	10 mm	3/8" BSPT	£12.81	£11.53
CDNSC1004N	10 mm	1/2" BSPT	£18.50	£16.65
CDNSC1202N	12 mm	1/4" BSPT	£18.60	£16.74
CDNSC1203N	12 mm	3/8" BSPT	£18.64	£16.78
CDNSC1204N	12 mm	1/2" BSPT	£18.76	£16.88

PART NUMBER	TUBE OD	THREAD	PRICE EACH	
			1 - 9	10 +
CDNSC04G1	4 mm	1/8" BSPP	£9.54	£8.59
CDNSC04G2	4 mm	1/4" BSPP	£10.00	£9.00
CDNSC06G1	6 mm	1/8" BSPP	£9.63	£8.66
CDNSC06G2	6 mm	1/4" BSPP	£9.98	£8.98
CDNSC06G3	6 mm	3/8" BSPP	£16.06	£14.45
CDNSC06G4	6 mm	1/2" BSPP	£17.84	£16.05
CDNSC08G1	8 mm	1/8" BSPP	£10.30	£9.27
CDNSC08G2	8 mm	1/4" BSPP	£10.32	£9.29
CDNSC08G3	8 mm	3/8" BSPP	£12.41	£11.17
CDNSC08G4	8 mm	1/2" BSPP	£17.15	£15.44
CDNSC10G1	10 mm	1/8" BSPP	£11.42	£10.28
CDNSC10G2	10 mm	1/4" BSPP	£12.78	£11.50
CDNSC10G3	10 mm	3/8" BSPP	£12.81	£11.53
CDNSC10G4	10 mm	1/2" BSPP	£18.50	£16.65
CDNSC12G2	12 mm	1/4" BSPP	£18.60	£16.74
CDNSC12G3	12 mm	3/8" BSPP	£18.64	£16.78
CDNSC12G4	12 mm	1/2" BSPP	£18.76	£16.88

Eleven

METER-OUT METHOD CONTROL (PREFERRED FOR CYLINDERS)

This product controls the air on the outlet to the tubing and allows free flow through the threaded port.

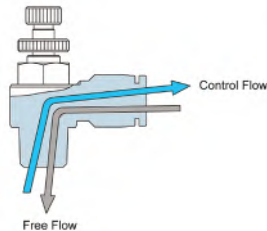

IMPERIAL THREAD TO THREAD

NSCF – SWIVEL ROTATING METAL BODY ELBOW

3700



PART NUMBER	MALE THREAD	FEMALE THREAD	PRICE EACH	
			1 - 9	10 +
CDNSCF01	1/8"	1/8"	£16.00	£14.40
CDNSCF02	1/4"	1/4"	£20.47	£18.42
CDNSCF03	3/8"	3/8"	£26.97	£24.27
CDNSCF04	1/2"	1/2"	£36.04	£32.44

IMPERIAL TUBE TO THREAD

New

PVSF – SWIVEL ROTATING METAL BODY ELBOW



3700

PART NUMBER	MALE / FEMALE THREAD	FEMALE PILOT	PRICE EACH	
			1 - 9	10 +
CDPVSF01N	1/8" BSPT	M5	£106.53	£95.87
CDPVSF02N	1/4" BSPT	1/8"	£116.67	£105.00
CDPVSF03N	3/8" BSPT	1/8"	£125.88	£113.29
CDPVSF04N	1/2" BSPT	1/4"	£146.73	£132.06

New

PVSF – SWIVEL ROTATING METAL BODY ELBOW



3700

PART NUMBER	MALE / FEMALE THREAD	FEMALE PILOT	PRICE EACH	
			1 - 9	10 +
CDPVSG01N	1/8" BSPP	M5	£106.53	£95.87
CDPVSG02N	1/4" BSPP	1/8"	£116.67	£105.00
CDPVSG03N	3/8" BSPP	1/8"	£125.88	£113.29
CDPVSG04N	1/2" BSPP	1/4"	£146.73	£132.06

METRIC TUBE TO THREAD

NSS – SWIVEL ROTATING IN-LINE



3700

PART NUMBER	TUBE OD	THREAD	PRICE EACH	
			1 - 9	10 +
CDNSS04M5	4 mm	M5 x 0.8	£9.16	£8.25
CDNSS0401	4 mm	1/8" BSPT	£10.49	£9.44
CDNSS0402	4 mm	1/4" BSPT	£11.00	£9.90
CDNSS06M5	6 mm	M5 x 0.8	£9.18	£8.26
CDNSS0601	6 mm	1/8" BSPT	£10.59	£9.53
CDNSS0602	6 mm	1/4" BSPT	£10.98	£9.88
CDNSS0603	6 mm	3/8" BSPT	£13.67	£12.30
CDNSS0801	8 mm	1/8" BSPT	£11.33	£10.20
CDNSS0802	8 mm	1/4" BSPT	£11.35	£10.21
CDNSS0803	8 mm	3/8" BSPT	£13.65	£12.29
CDNSS0804	8 mm	1/2" BSPT	£18.87	£16.98
CDNSS1002	10 mm	1/4" BSPT	£14.06	£12.66
CDNSS1003	10 mm	3/8" BSPT	£14.09	£12.68
CDNSS1004	10 mm	1/2" BSPT	£20.35	£18.31
CDNSS1202	12 mm	1/4" BSPT	£20.46	£18.41
CDNSS1203	12 mm	3/8" BSPT	£20.50	£18.45
CDNSS1204	12 mm	1/2" BSPT	£20.64	£18.57

NSS-G – SWIVEL ROTATING IN-LINE



3700

PART NUMBER	TUBE OD	THREAD	PRICE EACH	
			1 - 9	10 +
CDNSS04G1	4 mm	1/8" BSPP	£10.49	£9.44
CDNSS04G2	4 mm	1/4" BSPP	£11.00	£9.90
CDNSS06G1	6 mm	1/8" BSPP	£10.59	£9.53
CDNSS06G2	6 mm	1/4" BSPP	£10.98	£9.88
CDNSS06G3	6 mm	3/8" BSPP	£17.67	£15.90
CDNSS08G1	8 mm	1/8" BSPP	£11.33	£10.20
CDNSS08G2	8 mm	1/4" BSPP	£11.35	£10.21
CDNSS08G3	8 mm	3/8" BSPP	£13.65	£12.29
CDNSS08G4	8 mm	1/2" BSPP	£18.87	£16.98
CDNSS10G2	10 mm	1/4" BSPP	£14.06	£12.66
CDNSS10G3	10 mm	3/8" BSPP	£14.09	£12.68
CDNSS10G4	10 mm	1/2" BSPP	£20.35	£18.31
CDNSS12G2	12 mm	1/4" BSPP	£20.46	£18.41
CDNSS12G3	12 mm	3/8" BSPP	£20.50	£18.45
CDNSS12G4	12 mm	1/2" BSPP	£20.64	£18.57

NSC(D) – SWIVEL ROTATING ELBOW



3700

PART NUMBER	TUBE OD	THREAD	PRICE EACH	
			1 - 9	10 +
CDNSC03M5D	3 mm	M5 x 0.8	£8.04	£7.24
CDNSC04M5D	4 mm	M5 x 0.8	£8.33	£7.50
CDNSC0401D	4 mm	1/8" BSPT	£9.54	£8.59
CDNSC0402D	4 mm	1/4" BSPT	£10.00	£9.00
CDNSC06M5D	6 mm	M5 x 0.8	£8.34	£7.51
CDNSC0601D	6 mm	1/8" BSPT	£9.63	£8.66
CDNSC0602D	6 mm	1/4" BSPT	£9.98	£8.98
CDNSC0603D	6 mm	3/8" BSPT	£12.43	£11.19
CDNSC0604D	6 mm	1/2" BSPT	£17.84	£16.05
CDNSC0801D	8 mm	1/8" BSPT	£10.30	£9.27
CDNSC0802D	8 mm	1/4" BSPT	£10.32	£9.29
CDNSC0803D	8 mm	3/8" BSPT	£12.41	£11.17
CDNSC0804D	8 mm	1/2" BSPT	£17.15	£15.44
CDNSC1001D	10 mm	1/8" BSPT	£11.42	£10.28
CDNSC1002D	10 mm	1/4" BSPT	£12.78	£11.50
CDNSC1003D	10 mm	3/8" BSPT	£12.81	£11.53
CDNSC1004D	10 mm	1/2" BSPT	£18.50	£16.65
CDNSC1202D	12 mm	1/4" BSPT	£18.60	£16.74
CDNSC1203D	12 mm	3/8" BSPT	£18.64	£16.78
CDNSC1204D	12 mm	1/2" BSPT	£18.76	£16.88

NSC-G(D) – SWIVEL ROTATING ELBOW



3700

PART NUMBER	TUBE OD	THREAD	PRICE EACH	
			1 - 9	10 +
CDNSC04G1D	4 mm	1/8" BSPP	£9.54	£8.59
CDNSC04G2D	4 mm	1/4" BSPP	£10.00	£9.00
CDNSC06G1D	6 mm	1/8" BSPP	£9.63	£8.66
CDNSC06G2D	6 mm	1/4" BSPP	£9.98	£8.98
CDNSC06G3D	6 mm	3/8" BSPP	£16.06	£14.45
CDNSC06G4D	6 mm	1/2" BSPP	£17.84	£16.05
CDNSC08G1D	8 mm	1/8" BSPP	£10.30	£9.27
CDNSC08G2D	8 mm	1/4" BSPP	£10.32	£9.29
CDNSC08G3D	8 mm	3/8" BSPP	£12.41	£11.17
CDNSC08G4D	8 mm	1/2" BSPP	£17.15	£15.44
CDNSC10G1D	10 mm	1/8" BSPP	£11.42	£10.28
CDNSC10G2D	10 mm	1/4" BSPP	£12.78	£11.50
CDNSC10G3D	10 mm	3/8" BSPP	£12.81	£11.53
CDNSC10G4D	10 mm	1/2" BSPP	£18.50	£16.65
CDNSC12G2D	12 mm	1/4" BSPP	£18.60	£16.74
CDNSC12G3D	12 mm	3/8" BSPP	£18.64	£16.78
CDNSC12G4D	12 mm	1/2" BSPP	£18.76	£16.88

METRIC TUBE TO THREAD



3700



3700

NSS(D) – SWIVEL ROTATING IN-LINE

NSS-G(D) – SWIVEL ROTATING IN-LINE

PART NUMBER	TUBE OD	THREAD	PRICE EACH	
			1 - 9	10 +
CDNSS04M5D	4 mm	M5 x 0.8	£9.16	£8.25
CDNSS0401D	4 mm	1/8" BSPT	£10.49	£9.44
CDNSS0402D	4 mm	1/4" BSPT	£11.00	£9.90
CDNSS06M5D	6 mm	M5 x 0.8	£9.18	£8.26
CDNSS0601D	6 mm	1/8" BSPT	£10.59	£9.53
CDNSS0602D	6 mm	1/4" BSPT	£10.98	£9.88
CDNSS0603D	6 mm	3/8" BSPT	£13.67	£12.30
CDNSS0801D	8 mm	1/8" BSPT	£11.33	£10.20
CDNSS0802D	8 mm	1/4" BSPT	£11.35	£10.21
CDNSS0803D	8 mm	3/8" BSPT	£13.65	£12.29
CDNSS0804D	8 mm	1/2" BSPT	£18.87	£16.98
CDNSS1002D	10 mm	1/8" BSPT	£14.06	£12.66
CDNSS1003D	10 mm	3/8" BSPT	£14.09	£12.68
CDNSS1004D	10 mm	1/2" BSPT	£20.35	£18.31
CDNSS1202D	12 mm	1/4" BSPT	£20.46	£18.41
CDNSS1203D	12 mm	3/8" BSPT	£20.50	£18.45
CDNSS1204D	12 mm	1/2" BSPT	£20.64	£18.57

PART NUMBER	TUBE OD	THREAD	PRICE EACH	
			1 - 9	10 +
CDNSS04G1D	4 mm	1/8" BSPP	£10.49	£9.44
CDNSS04G2D	4 mm	1/4" BSPP	£11.00	£9.90
CDNSS06G1D	6 mm	1/8" BSPP	£10.59	£9.53
CDNSS06G2D	6 mm	1/4" BSPP	£10.98	£9.88
CDNSS06G3D	6 mm	3/8" BSPP	£17.67	£15.90
CDNSS08G1D	8 mm	1/8" BSPP	£11.33	£10.20
CDNSS08G2D	8 mm	1/4" BSPP	£11.35	£10.21
CDNSS08G3D	8 mm	3/8" BSPP	£13.65	£12.29
CDNSS08G4D	8 mm	1/2" BSPP	£18.87	£16.98
CDNSS10G2D	10 mm	1/4" BSPP	£14.06	£12.66
CDNSS10G3D	10 mm	3/8" BSPP	£14.09	£12.68
CDNSS10G4D	10 mm	1/2" BSPP	£20.35	£18.31
CDNSS12G2D	12 mm	1/4" BSPP	£20.46	£18.41
CDNSS12G3D	12 mm	3/8" BSPP	£20.50	£18.45
CDNSS12G4D	12 mm	1/2" BSPP	£20.64	£18.57



3700



3700

NSC(DC) – SWIVEL ROTATING ELBOW

NSC-G(DC) – SWIVEL ROTATING ELBOW

PART NUMBER	TUBE OD	THREAD	PRICE EACH	
			1 - 9	10 +
CDNSC03M5DC	3 mm	M5 x 0.8	£8.85	£7.96
CDNSC04M5DC	4 mm	M5 x 0.8	£9.16	£8.25
CDNSC0401DC	4 mm	1/8" BSPT	£10.49	£9.44
CDNSC0402DC	4 mm	1/4" BSPT	£11.00	£9.90
CDNSC06M5DC	6 mm	M5 x 0.8	£9.18	£8.26
CDNSC0601DC	6 mm	1/8" BSPT	£10.59	£9.53
CDNSC0602DC	6 mm	1/4" BSPT	£10.98	£9.88
CDNSC0603DC	6 mm	3/8" BSPT	£13.67	£12.30
CDNSC0604DC	6 mm	1/2" BSPT	£19.62	£17.66
CDNSC0801DC	8 mm	1/8" BSPT	£11.33	£10.20
CDNSC0802DC	8 mm	1/4" BSPT	£11.35	£10.21
CDNSC0803DC	8 mm	3/8" BSPT	£13.65	£12.29
CDNSC0804DC	8 mm	1/2" BSPT	£18.87	£16.98
CDNSC1001DC	10 mm	1/8" BSPT	£12.57	£11.31
CDNSC1002DC	10 mm	1/4" BSPT	£14.06	£12.66
CDNSC1003DC	10 mm	3/8" BSPT	£14.09	£12.68
CDNSC1004DC	10 mm	1/2" BSPT	£20.35	£18.31
CDNSC1202DC	12 mm	1/4" BSPT	£20.46	£18.41
CDNSC1203DC	12 mm	3/8" BSPT	£20.50	£18.45
CDNSC1204DC	12 mm	1/2" BSPT	£20.64	£18.57

PART NUMBER	TUBE OD	THREAD	PRICE EACH	
			1 - 9	10 +
CDNSC04G1DC	4 mm	1/8" BSPP	£10.49	£9.44
CDNSC04G2DC	4 mm	1/4" BSPP	£11.00	£9.90
CDNSC06G1DC	6 mm	1/8" BSPP	£10.59	£9.53
CDNSC06G2DC	6 mm	1/4" BSPP	£10.98	£9.88
CDNSC06G3DC	6 mm	3/8" BSPP	£17.67	£15.90
CDNSC06G4DC	6 mm	1/2" BSPP	£19.62	£17.66
CDNSC08G1DC	8 mm	1/8" BSPP	£11.33	£10.20
CDNSC08G2DC	8 mm	1/4" BSPP	£11.35	£10.21
CDNSC08G3DC	8 mm	3/8" BSPP	£13.65	£12.29
CDNSC08G4DC	8 mm	1/2" BSPP	£18.87	£16.98
CDNSC10G1DC	10 mm	1/8" BSPP	£12.57	£11.31
CDNSC10G2DC	10 mm	1/4" BSPP	£14.06	£12.66
CDNSC10G3DC	10 mm	3/8" BSPP	£14.09	£12.68
CDNSC10G4DC	10 mm	1/2" BSPP	£20.35	£18.31
CDNSC12G2DC	12 mm	1/4" BSPP	£20.46	£18.41
CDNSC12G3DC	12 mm	3/8" BSPP	£20.50	£18.45
CDNSC12G4DC	12 mm	1/2" BSPP	£20.64	£18.57

METRIC TUBE TO THREAD



NSS(DC) – SWIVEL ROTATING IN-LINE

3700

PART NUMBER	TUBE OD	THREAD	PRICE EACH	
			1 - 9	10 +
CDNSS04M5DC	4 mm	M5 x 0.8	£10.08	£9.07
CDNSS0401DC	4 mm	1/8" BSPT	£11.54	£10.39
CDNSS0402DC	4 mm	1/4" BSPT	£12.11	£10.90
CDNSS06M5DC	6 mm	M5 x 0.8	£10.09	£9.08
CDNSS0601DC	6 mm	1/8" BSPT	£11.65	£10.48
CDNSS0602DC	6 mm	1/4" BSPT	£12.08	£10.87
CDNSS0603DC	6 mm	3/8" BSPT	£15.04	£13.54
CDNSS0801DC	8 mm	1/8" BSPT	£12.47	£11.22
CDNSS0802DC	8 mm	1/4" BSPT	£12.48	£11.23
CDNSS0803DC	8 mm	3/8" BSPT	£15.02	£13.51
CDNSS0804DC	8 mm	1/2" BSPT	£20.75	£18.67
CDNSS1002DC	10 mm	1/4" BSPT	£15.47	£13.92
CDNSS1003DC	10 mm	3/8" BSPT	£15.50	£13.95
CDNSS1004DC	10 mm	1/2" BSPT	£22.39	£20.15
CDNSS1202DC	12 mm	1/4" BSPT	£22.51	£20.25
CDNSS1203DC	12 mm	3/8" BSPT	£22.55	£20.30
CDNSS1204DC	12 mm	1/2" BSPT	£22.70	£20.43



NSS-G(DC) – SWIVEL ROTATING IN-LINE

3700

PART NUMBER	TUBE OD	THREAD	PRICE EACH	
			1 - 9	10 +
CDNSS04G1DC	4 mm	1/8" BSPP	£11.54	£10.39
CDNSS04G2DC	4 mm	1/4" BSPP	£12.11	£10.90
CDNSS06G1DC	6 mm	1/8" BSPP	£11.65	£10.48
CDNSS06G2DC	6 mm	1/4" BSPP	£12.08	£10.87
CDNSS06G3DC	6 mm	3/8" BSPP	£19.43	£17.49
CDNSS08G1DC	8 mm	1/8" BSPP	£12.47	£11.22
CDNSS08G2DC	8 mm	1/4" BSPP	£12.48	£11.23
CDNSS08G3DC	8 mm	3/8" BSPP	£15.02	£13.51
CDNSS08G4DC	8 mm	1/2" BSPP	£20.75	£18.67
CDNSS10G2DC	10 mm	1/4" BSPP	£15.47	£13.92
CDNSS10G3DC	10 mm	3/8" BSPP	£15.50	£13.95
CDNSS10G4DC	10 mm	1/2" BSPP	£22.39	£20.15
CDNSS12G2DC	12 mm	1/4" BSPP	£22.51	£20.25
CDNSS12G3DC	12 mm	3/8" BSPP	£22.55	£20.30
CDNSS12G4DC	12 mm	1/2" BSPP	£22.70	£20.43

Eleven

METRIC TUBE TO TUBE



NSF STRAIGHT UNION

3700

PART NUMBER	TUBE OD	PRICE EACH	
		1 - 9	10 +
CDNSF04N	4 mm	£10.41	£9.37
CDNSF06N	6 mm	£11.99	£10.79
CDNSF08N	8 mm	£13.73	£12.35
CDNSF10N	10 mm	£15.34	£13.80
CDNSF12N	12 mm	£17.14	£15.43

IMPERIAL TUBE TO TUBE



NSF STRAIGHT UNION

3700

PART NUMBER	TUBE OD	PRICE EACH	
		1 - 9	10 +
CDNSF1/4	1/4"	£14.39	£12.95
CDNSF3/8	3/8"	£18.40	£16.56
CDNSF1/2	1/2"	£20.57	£18.52



NSFB STRAIGHT BULKHEAD UNION

3700

PART NUMBER	TUBE OD	TUBE OD	PRICE EACH	
			1 - 9	10 +
CDNSFB04N	4 mm	4 mm	£13.15	£11.83
CDNSFB06N	6 mm	6 mm	£15.28	£13.75
CDNSFB08N	8 mm	8 mm	£18.98	£17.08
CDNSFB10N	10 mm	10 mm	£23.39	£21.05
CDNSFB12N	12 mm	12 mm	£27.92	£25.13

SPEED CONTROLLERS WITH PILOT CHECK VALVES

FEATURES

- Combined pilot check valve and speed controller
- Enables 360° free direction of tubing mount

APPLICATIONS

- Realises momentary intermediate stoppage of a cylinder and able to adjust speed control of it

SPECIFICATIONS

Fluid type	Air (No other type of gas or liquid)
Working pressure	1.4 to 150 psi (10.2 bar)
Negative pressure	-29.5 in Hg / -750 mm Hg (-750 Torr)
Working temperature	0°C to +60°C (+32°F to +140°F)
Application tube	Polyurethane and nylon

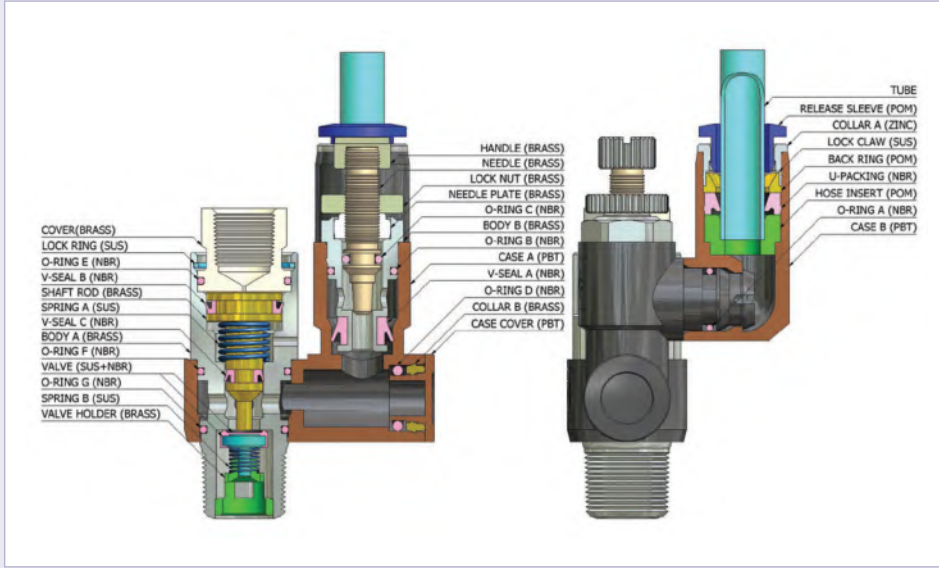

TUBE TO THREAD



3700



3700

PVSC – SWIVEL ROTATING WITH PILOT CHECK VALVE

PART NUMBER	TUBE OD	THREAD	PILOT PORT	PRICE EACH	
				1 - 9	10 +
CDPVSC0601	6 mm	1/8" BSPT	M5	£56.25	£50.63
CDPVSC0602	6 mm	1/4" BSPT	1/8" BSPT	£66.69	£60.02
CDPVSC0801	8 mm	1/8" BSPT	M5	£56.27	£50.64
CDPVSC0802	8 mm	1/4" BSPT	1/8" BSPT	£66.70	£60.03
CDPVSC0803	8 mm	3/8" BSPT	1/8" BSPT	£79.04	£71.14
CDPVSC1003	10 mm	3/8" BSPT	1/8" BSPT	£79.10	£71.19
CDPVSC1004	10 mm	1/2" BSPT	1/4" BSPT	£104.78	£94.30
CDPVSC1203	12 mm	3/8" BSPT	1/8" BSPT	£79.23	£71.30
CDPVSC1204	12 mm	1/2" BSPT	1/4" BSPT	£104.90	£94.41

PVSC-G – SWIVEL ROTATING WITH PILOT CHECK VALVE

PART NUMBER	TUBE OD	THREAD	PILOT PORT	PRICE EACH	
				1 - 9	10 +
CDPVSC06G1	6 mm	1/8" BSPP	M5	£59.07	£53.16
CDPVSC06G2	6 mm	1/4" BSPP	1/8" BSPT	£70.02	£63.02
CDPVSC08G1	8 mm	1/8" BSPP	M5	£59.07	£53.17
CDPVSC08G2	8 mm	1/4" BSPP	1/8" BSPT	£70.04	£63.04
CDPVSC08G3	8 mm	3/8" BSPP	1/8" BSPT	£83.00	£74.70
CDPVSC10G3	10 mm	3/8" BSPP	1/8" BSPT	£83.06	£74.75
CDPVSC10G4	10 mm	1/2" BSPP	1/4" BSPT	£110.02	£99.02
CDPVSC12G3	12 mm	3/8" BSPP	1/8" BSPT	£83.19	£74.87
CDPVSC12G4	12 mm	1/2" BSPP	1/4" BSPT	£110.15	£99.14

SILENCERS

FEATURES

- Made from corrosion resistant plastic
- Competitively priced, lightweight and durable
- Very compact, can be easily installed in limited spaces

APPLICATIONS

- Installed at exhaust ports to diminish ventilation noise

SPECIFICATIONS	1/8", 1/4", 3/8"	1/2", 3/4", 1"
Max. working pressure	100 psi (6.9 bar)	150 psi (10.2 bar)

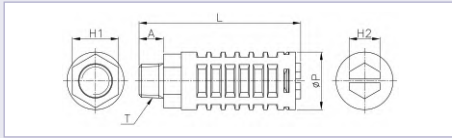

DIMENSIONS	ØP	T	L	A	H1 (Hex)	H2 (Hex)	WEIGHT
CDST-01	10.5	R 1/8	35.3	8.0	-	6	1.9
CDST-02	22.2	R 1/4	63.0	9.5	18	12	14.1
CDST-03	25.0	R 3/8	83.2	13.7	21	15	22.2
CDST-04	30.0	R 1/2	88.0	15.5	26	19	31.1
CDST-06	45.0	R 3/4	101.0	16.8	33	-	63.7
CDST-08	45.0	R 1	103.5	16.8	33	-	65.4

FEATURES

- Excellent noise reduction and filtering effect in dry conditions

APPLICATIONS

- Metal filters are available for high temperature and pressure environments
- Durable against impact
- Easy to weld and used for virtually every industry

SPECIFICATIONS	M5	1/8"	1/4"	3/8"	1/2"	3/4"	1"
Flow rate	250	300	320	340	370	400	420
Max. working pressure	220 psi (15.1 bar)						
Working temperature	0°C – 80°C (+32°F to 176°F)						

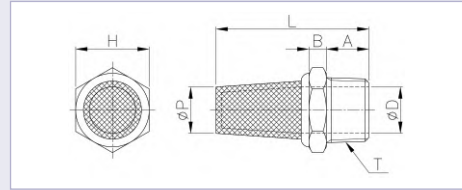

DIMENSIONS	ØP	T	L	A	H (Hex)	WEIGHT
CDSTB-M5	7.0	M5*0.8P	18.0	4.0	7	3.0
CDSTB-01	8.0	R 1/8	23.5	6.5	11	8.0
CDSTB-02	11.5	R 1/4	33.0	8.5	16	14.0
CDSTB-03	13.0	R 3/8	38.0	9.0	19	24.0
CDSTB-04	16.0	R 1/2	43.0	12.5	22	35.0
CDSTB-06	18.0	R 3/4	52.0	15.0	28	46.0
CDSTB-08	24.0	R 1	82.0	19.0	35	128.0

E11even

ST PLASTIC



PART NUMBER	OD	THREAD	PRICE EACH	
			1 - 9	10 +
CDST-01	10.5 mm	1/8" BSPT	£2.28	£2.05
CDST-02	22.2 mm	1/4" BSPT	£2.86	£2.57
CDST-03	25.0 mm	3/8" BSPT	£3.44	£3.09
CDST-04	30.0 mm	1/2" BSPT	£4.04	£3.64
CDST-06	45.0 mm	3/4" BSPT	£27.95	£25.16
CDST-08	45.0 mm	1" BSPT	£27.95	£25.16

STB SINTERED BRASS



PART NUMBER	THREAD	PRICE EACH	
		1 - 9	10 +
CDSTB-M5	M5 x 0.8	£1.05	£0.95
CDSTB-01	1/8" BSPT	£1.45	£1.30
CDSTB-02	1/4" BSPT	£2.30	£2.07
CDSTB-03	3/8" BSPT	£4.21	£3.79
CDSTB-04	1/2" BSPT	£5.79	£5.21
CDSTB-06	3/4" BSPT	£12.63	£11.37
CDSTB-08	1" BSPT	£22.36	£20.12

FEATURES

- This product switches compressed air on / off on air pressure devices by simply turning the handle
- Maintenance or inspection is possible when the remaining pressure in the device is removed
- A three-way valve discharges the remaining pressure out, and blocks the incoming air in the off state
- Four types available depending on the method applied to air pressure flow

APPLICATIONS

- Used for switching compressed air

SPECIFICATIONS

Fluid type	Air (No other type of gas or liquid)
Working pressure	0 to 150 psi (10.2 bar)
Negative pressure	-29.5 in Hg / -750 mm Hg (-750 Torr)
Working temperature	0°C to +60°C (+32°F to +140°F)
Application tube	Polyurethane and nylon

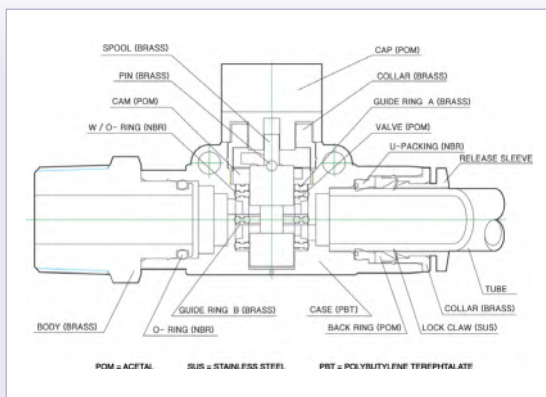

TUBE TO THREAD



3700

HVC
STRAIGHT 'A' VALVE

PART NUMBER	TUBE OD	THREAD	PRICE EACH	
			1 - 9	10 +
CDHVC0401	4 mm	1/8" BSPT	£10.10	£9.09
CDHVC0402	4 mm	1/4" BSPT	£10.49	£9.44
CDHVC0403	4 mm	3/8" BSPT	£10.88	£9.79
CDHVC0601	6 mm	1/8" BSPT	£10.10	£9.09
CDHVC0602	6 mm	1/4" BSPT	£10.49	£9.44
CDHVC0603	6 mm	3/8" BSPT	£10.88	£9.79
CDHVC0801	8 mm	1/8" BSPT	£10.88	£9.79
CDHVC0802	8 mm	1/4" BSPT	£11.27	£10.14
CDHVC0803	8 mm	3/8" BSPT	£11.66	£10.49
CDHVC1002	10 mm	1/4" BSPT	£11.66	£10.49
CDHVC1003	10 mm	3/8" BSPT	£12.05	£10.84
CDHVC1004	10 mm	1/2" BSPT	£12.51	£11.26
CDHVC1202	12 mm	1/4" BSPT	£12.51	£11.26
CDHVC1203	12 mm	3/8" BSPT	£12.82	£11.54
CDHVC1204	12 mm	1/2" BSPT	£13.21	£11.89



3700

HVC-G
STRAIGHT 'A' VALVE

PART NUMBER	TUBE OD	THREAD	PRICE EACH	
			1 - 9	10 +
CDHVC04G01	4 mm	1/8" BSPP	£10.10	£9.09
CDHVC04G02	4 mm	1/4" BSPP	£10.49	£9.44
CDHVC04G03	4 mm	3/8" BSPP	£10.88	£9.79
CDHVC06G01	6 mm	1/8" BSPP	£10.10	£9.09
CDHVC06G02	6 mm	1/4" BSPP	£10.49	£9.44
CDHVC06G03	6 mm	3/8" BSPP	£10.88	£9.79
CDHVC08G01	8 mm	1/8" BSPP	£10.88	£9.79
CDHVC08G02	8 mm	1/4" BSPP	£11.27	£10.14
CDHVC08G03	8 mm	3/8" BSPP	£11.66	£10.49
CDHVC10G02	10 mm	1/4" BSPP	£11.66	£10.49
CDHVC10G03	10 mm	3/8" BSPP	£12.05	£10.84
CDHVC10G04	10 mm	1/2" BSPP	£12.51	£11.26
CDHVC12G02	12 mm	1/4" BSPP	£12.51	£11.26
CDHVC12G03	12 mm	3/8" BSPP	£12.82	£11.54
CDHVC12G04	12 mm	1/2" BSPP	£13.21	£11.89



3700

HVF
STRAIGHT 'B' VALVE

PART NUMBER	THREAD	TUBE OD	PRICE EACH	
			1 - 9	10 +
CDHVF0104	1/8" BSPT	4 mm	£10.10	£9.09
CDHVF0204	1/4" BSPT	4 mm	£10.88	£9.79
CDHVF0304	3/8" BSPT	4 mm	£11.66	£10.49
CDHVF0106	1/8" BSPT	6 mm	£10.10	£9.09
CDHVF0206	1/4" BSPT	6 mm	£10.88	£9.79
CDHVF0306	3/8" BSPT	6 mm	£11.66	£10.49
CDHVF0108	1/8" BSPT	8 mm	£10.49	£9.44
CDHVF0208	1/4" BSPT	8 mm	£10.88	£9.79
CDHVF0308	3/8" BSPT	8 mm	£12.05	£10.84
CDHVF0210	1/4" BSPT	10 mm	£11.27	£10.14
CDHVF0310	3/8" BSPT	10 mm	£12.51	£11.26
CDHVF0410	1/2" BSPT	10 mm	£12.82	£11.54
CDHVF0212	1/4" BSPT	12 mm	£11.66	£10.49
CDHVF0312	3/8" BSPT	12 mm	£12.51	£11.26
CDHVF0412	1/2" BSPT	12 mm	£13.21	£11.89



3700

HVF-G
STRAIGHT 'B' VALVE

PART NUMBER	THREAD	TUBE OD	PRICE EACH	
			1 - 9	10 +
CDHVFG0104	1/8" BSPP	4 mm	£10.10	£9.09
CDHVFG0204	1/4" BSPP	4 mm	£10.88	£9.79
CDHVFG0304	3/8" BSPP	4 mm	£11.66	£10.49
CDHVFG0106	1/8" BSPP	6 mm	£10.10	£9.09
CDHVFG0206	1/4" BSPP	6 mm	£10.88	£9.79
CDHVFG0306	3/8" BSPP	6 mm	£11.66	£10.49
CDHVFG0108	1/8" BSPP	8 mm	£10.49	£9.44
CDHVFG0208	1/4" BSPP	8 mm	£10.88	£9.79
CDHVFG0308	3/8" BSPP	8 mm	£12.05	£10.84
CDHVFG0210	1/4" BSPP	10 mm	£11.27	£10.14
CDHVFG0310	3/8" BSPP	10 mm	£12.51	£11.26
CDHVFG0410	1/2" BSPP	10 mm	£12.82	£11.54
CDHVFG0212	1/4" BSPP	12 mm	£11.66	£10.49
CDHVFG0312	3/8" BSPP	12 mm	£12.51	£11.26
CDHVFG0412	1/2" BSPP	12 mm	£13.21	£11.89

BSPT THREAD HAND VALVES



HVM
NIPPLE VALVE

3700

PART NUMBER	THREAD (A)	THREAD (B)	PRICE EACH	
			1 - 9	10 +
CDHVM0101	1/8" BSPT	1/8" BSPT	£10.88	£9.79
CDHVM0201	1/4" BSPT	1/8" BSPT	£11.66	£10.49
CDHVM0202	1/4" BSPT	1/4" BSPT	£12.51	£11.26
CDHVM0302	3/8" BSPT	1/4" BSPT	£13.21	£11.89
CDHVM0303	3/8" BSPT	3/8" BSPT	£13.99	£12.59
CDHVM0403	1/2" BSPT	3/8" BSPT	£14.76	£13.29
CDHVM0404	1/2" BSPT	1/2" BSPT	£15.54	£13.99



HSV
HAND SLIDE VALVE

3700

PART NUMBER	THREAD	PRICE EACH	
		1 - 9	10 +
CDHSVM-M5	M5 x 0.8	£9.73	£8.76
CDHSVM-01	1/8" BSPT	£12.43	£11.19
CDHSVM-02	1/4" BSPT	£21.27	£19.14
CDHSVM-03	3/8" BSPT	£37.95	£34.16
CDHSVM-04	1/2" BSPT	£40.89	£36.80
CDHSVM-06	3/4" BSPT	£52.10	£46.89

METRIC TUBE TO TUBE

To insert the tube into the fitting, insert it fully to the end, and to release, shut off the compressed air and push the sleeve gently to pull the tube out.

Be sure to select the product according to your needs, as hand valves vent the downstream line using a three-way method, so leakage may occur when fluids other than air are applied.

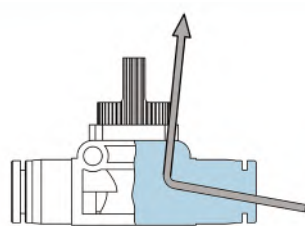

BSPP THREAD



HVU
STRAIGHT UNION VALVE

3700

PART NUMBER	TUBE OD (A)	TUBE OD (B)	PRICE EACH	
			1 - 9	10 +
CDHVU0404	4 mm	4 mm	£9.32	£8.39
CDHVU0606	6 mm	6 mm	£9.32	£8.39
CDHVU0806	8 mm	6 mm	£10.10	£9.09
CDHVU0808	8 mm	8 mm	£10.10	£9.09
CDHVU1008	10 mm	8 mm	£10.88	£9.79
CDHVU1010	10 mm	10 mm	£10.88	£9.79
CDHVU1210	12 mm	10 mm	£11.66	£10.49
CDHVU1212	12 mm	12 mm	£11.66	£10.49

HAND BALL VALVES



HBVU
IMPERIAL HAND BALL VALVE

3720

PART NUMBER	TUBE OD	PRICE EACH	
		1 - 9	10 +
CDHBVU1/4-1/4	1/4"	£5.83	£5.11
CDHBVU5/16-5/16	5/16"	£5.97	£5.24
CDHBVU3/8-3/8	3/8"	£6.35	£5.57
CDHBVU1/2-1/2	1/2"	£6.56	£5.75



HBVU
METRIC HAND BALL VALVE

3720

PART NUMBER	TUBE OD	PRICE EACH	
		1 - 9	10 +
CDHBVU0606	6 mm	£7.61	£6.80
CDHBVU0808	8 mm	£7.71	£6.90
CDHBVU1010	10 mm	£8.30	£7.42
CDHBVU1212	12 mm	£8.49	£7.60

HVM-G
NIPPLE VALVE



3700

PART NUMBER	THREAD (A)	THREAD (B)	PRICE EACH	
			1 - 9	10 +
CDHVMG0101	1/8" BSPP	1/8" BSPP	£10.88	£9.79
CDHVMG0201	1/4" BSPP	1/8" BSPP	£11.66	£10.49
CDHVMG0202	1/4" BSPP	1/4" BSPP	£12.51	£11.26
CDHVMG0302	3/8" BSPP	1/4" BSPP	£13.21	£11.89
CDHVMG0303	3/8" BSPP	3/8" BSPP	£13.99	£12.59
CDHVMG0403	1/2" BSPP	3/8" BSPP	£14.76	£13.29
CDHVMG0404	1/2" BSPP	1/2" BSPP	£15.54	£13.99

FEATURES

- Air is completely blocked when the tube is released, and the air flows again only after connection, to ensure safety. The air flows only when the tube is connected.

APPLICATIONS

- Used where pneumatic piping frequently changes

SPECIFICATIONS

Fluid type	Air (No other type of gas or liquid)
Working pressure	0 to 150 psi (10.2 bar)
Negative pressure	-29.5 in Hg -750 mm Hg (-750 Torr)
Working temperature	0°C to +60°C (+32°F to +140°F)
Application tube	Polyurethane and nylon

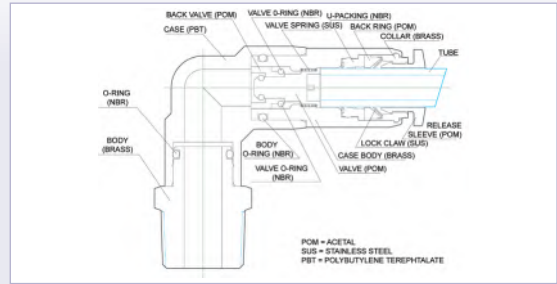

METRIC TUBE TO THREAD

SPC MALE STRAIGHT



3700

PART NUMBER	TUBE OD	THREAD	PRICE EACH	
			1 - 9	10 +
CDSPC0401	4 mm	1/8" BSPT	£6.93	£6.24
CDSPC0601	6 mm	1/8" BSPT	£7.01	£6.31
CDSPC0602	6 mm	1/4" BSPT	£7.27	£6.54
CDSPC0802	8 mm	1/4" BSPT	£8.18	£7.36
CDSPC0803	8 mm	3/8" BSPT	£9.93	£8.94
CDSPC1002	10 mm	1/4" BSPT	£10.02	£9.02
CDSPC1003	10 mm	3/8" BSPT	£10.27	£9.24
CDSPC1004	10 mm	1/2" BSPT	£11.27	£10.14
CDSPC1202	12 mm	1/4" BSPT	£11.69	£10.52
CDSPC1203	12 mm	3/8" BSPT	£11.94	£10.75
CDSPC1204	12 mm	1/2" BSPT	£12.27	£11.04

SPC-G MALE STRAIGHT



3700

PART NUMBER	TUBE OD	THREAD	PRICE EACH	
			1 - 9	10 +
CDSPC04G01	4 mm	1/8" BSPP	£6.93	£6.24
CDSPC06G01	6 mm	1/8" BSPP	£7.01	£6.31
CDSPC06G02	6 mm	1/4" BSPP	£7.27	£6.54
CDSPC08G02	8 mm	1/4" BSPP	£8.18	£7.36
CDSPC08G03	8 mm	3/8" BSPP	£9.93	£8.94
CDSPC10G02	10 mm	1/4" BSPP	£10.02	£9.02
CDSPC10G03	10 mm	3/8" BSPP	£10.27	£9.24
CDSPC10G04	10 mm	1/2" BSPP	£11.27	£10.14
CDSPC12G02	12 mm	1/4" BSPP	£11.69	£10.52
CDSPC12G03	12 mm	3/8" BSPP	£11.94	£10.75
CDSPC12G04	12 mm	1/2" BSPP	£12.27	£11.04

SPL MALE ELBOW



3700

PART NUMBER	TUBE OD	THREAD	PRICE EACH	
			1 - 9	10 +
CDSPL04M5	4 mm	M5 x 0.8	£8.02	£7.21
CDSPL04M6	4 mm	M6 x 1.0	£8.35	£7.52
CDSPL0401	4 mm	1/8" BSPT	£7.52	£6.77
CDSPL06M5	6 mm	M5 x 0.8	£10.63	£9.57
CDSPL0601	6 mm	1/8" BSPT	£8.02	£7.21
CDSPL0602	6 mm	1/4" BSPT	£8.35	£7.52
CDSPL0801	8 mm	1/8" BSPT	£10.63	£9.57
CDSPL0802	8 mm	1/4" BSPT	£10.63	£9.57
CDSPL0803	8 mm	3/8" BSPT	£10.44	£9.39
CDSPL1002	10 mm	1/4" BSPT	£11.77	£10.60
CDSPL1003	10 mm	3/8" BSPT	£11.94	£10.75
CDSPL1004	10 mm	1/2" BSPT	£13.61	£12.25
CDSPL1203	12 mm	3/8" BSPT	£16.28	£14.65
CDSPL1204	12 mm	1/2" BSPT	£16.70	£15.03

SPL-G MALE ELBOW



3700

PART NUMBER	TUBE OD	THREAD	PRICE EACH	
			1 - 9	10 +
CDSPL04G01	4 mm	1/8" BSPP	£7.52	£6.77
CDSPL06G01	6 mm	1/8" BSPP	£8.02	£7.21
CDSPL06G02	6 mm	1/4" BSPP	£8.35	£7.52
CDSPL08G01	8 mm	1/8" BSPP	£10.63	£9.57
CDSPL08G02	8 mm	1/4" BSPP	£10.63	£9.57
CDSPL08G03	8 mm	3/8" BSPP	£10.44	£9.39
CDSPL10G02	10 mm	1/4" BSPP	£11.77	£10.60
CDSPL10G03	10 mm	3/8" BSPP	£11.94	£10.75
CDSPL10G04	10 mm	1/2" BSPP	£13.61	£12.25
CDSPL12G03	12 mm	3/8" BSPP	£16.28	£14.65
CDSPL12G04	12 mm	1/2" BSPP	£16.37	£15.03

METRIC TUBE TO TUBE

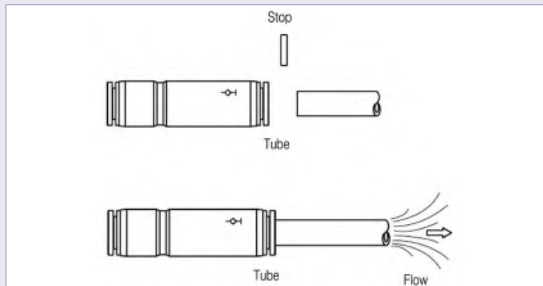

SPU STRAIGHT STOP UNION



3700

PART NUMBER	TUBE OD	PRICE EACH	
		1 - 9	10 +
CDSPU04	4 mm	£7.52	£6.77
CDSPU06	6 mm	£10.63	£9.57
CDSPU08	8 mm	£10.02	£9.02
CDSPU10	10 mm	£11.27	£10.14
CDSPU12	12 mm	£11.77	£10.60

FEATURES

- Suitable for low pressure applications
- Allows compressed air from one side to flow and blocks the inverse flow to protect and maintain the vacuum line
- Easily applied to low pressure piping

APPLICATIONS

- Used where air should flow in only one direction
- Used where air pressure of the ventilation section should be kept uniform
- Good for low pressure devices

SPECIFICATIONS

Fluid type	Air (No other type of gas or liquid)
Working pressure	0 to 150 psi (10.2 bar)
Negative pressure	-29.5 in Hg -750 mm Hg (-750 Torr)
Working temperature	0°C to +60°C (+32°F to +140°F)
Application tube	Polyurethane and nylon

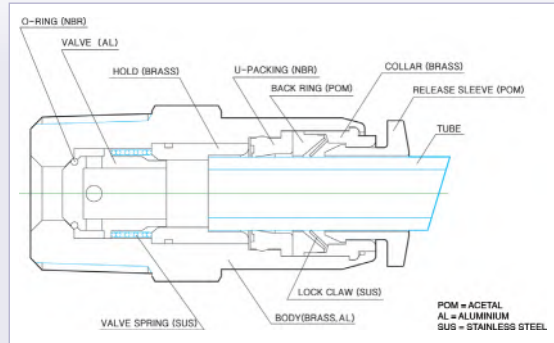

TUBE TO THREAD



**CVPC
MALE STRAIGHT**

3700

PART NUMBER	TUBE OD	THREAD	PRICE EACH	
			1 - 9	10 +
CDCVPC04M5	4 mm	M5 x 0.8	£7.52	£6.77
CDCVPC04M6	4 mm	M6 x 1.0	£7.52	£6.77
CDCVPC0401	4 mm	1/8" BSPT	£8.02	£7.21
CDCVPC0601	6 mm	1/8" BSPT	£10.63	£9.57
CDCVPC0602	6 mm	1/4" BSPT	£10.63	£9.57
CDCVPC0801	8 mm	1/8" BSPT	£9.52	£8.57
CDCVPC0802	8 mm	1/4" BSPT	£10.02	£9.02
CDCVPC1003	10 mm	3/8" BSPT	£21.04	£18.94
CDCVPC1004	10 mm	1/2" BSPT	£22.13	£19.91
CDCVPC1203	12 mm	3/8" BSPT	£21.79	£19.61
CDCVPC1204	12 mm	1/2" BSPT	£22.79	£20.51



**CVPC-G
MALE STRAIGHT**

3700

PART NUMBER	TUBE OD	THREAD	PRICE EACH	
			1 - 9	10 +
CDCVPC04G1	4 mm	1/8" BSPP	£8.02	£7.21
CDCVPC06G1	6 mm	1/8" BSPP	£10.63	£9.57
CDCVPC06G2	6 mm	1/4" BSPP	£10.63	£9.57
CDCVPC08G1	8 mm	1/8" BSPP	£9.52	£8.57
CDCVPC08G2	8 mm	1/4" BSPP	£10.02	£9.02
CDCVPC10G3	10 mm	3/8" BSPP	£21.04	£18.94
CDCVPC10G4	10 mm	1/2" BSPP	£22.13	£19.91
CDCVPC12G3	12 mm	3/8" BSPP	£21.79	£19.61
CDCVPC12G4	12 mm	1/2" BSPP	£22.79	£20.51

METRIC TUBE TO TUBE



**CVPU
STRAIGHT UNION**

3700

PART NUMBER	TUBE OD	PRICE EACH	
		1 - 9	10 +
CDCVPU04	4 mm	£8.02	£7.21
CDCVPU06	6 mm	£10.63	£9.57
CDCVPU08	8 mm	£11.02	£9.92
CDCVPU10	10 mm	£24.80	£22.32
CDCVPU12	12 mm	£26.36	£23.73

THREAD TO THREAD



**CVPF
BUSH**

3700

PART NUMBER	FEMALE THREAD	MALE THREAD	PRICE EACH	
			1 - 9	10 +
CDCVPF0101	1/8" BSPT	1/8" BSPT	£10.63	£9.57
CDCVPF0202	1/4" BSPT	1/4" BSPT	£10.02	£9.02
CDCVPF0303	3/8" BSPT	3/8" BSPT	£10.63	£9.57
CDCVPF0404	1/2" BSPT	1/2" BSPT	£19.79	£17.81



**CVPF-G
BUSH**

3700

PART NUMBER	FEMALE THREAD	MALE THREAD	PRICE EACH	
			1 - 9	10 +
CDCVPF01G1	1/8" BSPP	1/8" BSPP	£10.63	£9.57
CDCVPF02G2	1/4" BSPP	1/4" BSPP	£10.02	£9.02
CDCVPF03G3	3/8" BSPP	3/8" BSPP	£10.63	£9.57
CDCVPF04G4	1/2" BSPP	1/2" BSPP	£19.79	£17.81



**CVFF
STRAIGHT UNION**

3700

PART NUMBER	THREAD	PRICE EACH	
		1 - 9	10 +
CDCVFF01-01	1/8" BSPT	£9.49	£8.54
CDCVFF02-02	1/4" BSPT	£12.59	£11.33
CDCVFF03-03	3/8" BSPT	£18.51	£16.66
CDCVFF04-04	1/2" BSPT	£21.01	£18.91

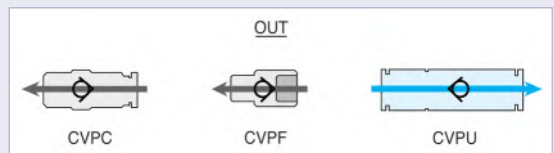

Fitting material aluminium.

TWO TOUCH FITTINGS

FEATURES

- The connection method is nut tightening and efficient in environments with vibration
- Made from plastics which have good tolerance to corrosion and chemicals
- Suited for low air pressure devices

APPLICATIONS

- A nut tightening pipe connection tool for devices that use pneumatic piping

SPECIFICATIONS

Fluid type	Air / water & fluid (not suitable for potable water)
Working pressure	0 to 150 psi (10.2 bar)
Negative pressure	-29.5 in Hg -750 mm Hg (-750 Torr)
Working temperature	0°C to +60°C (+32°F to +140°F)
Application tube	Polyurethane tube

METRIC TUBE TO TUBE



FCK
UNION TEE

3700

PART NUMBER	TUBE OD/ID	PRICE EACH	
		1 - 9	10 +
CDFK06	6/4 mm	£2.91	£2.61
CDFK08	8/5.5 mm	£3.11	£2.80
CDFK10	10/6.5 mm	£3.41	£3.07
CDFK12	12/8 mm	£3.75	£3.37

TUBE TO THREAD



CK
MALE STRAIGHT

3700

PART NUMBER	TUBE OD/ID	THREAD	PRICE EACH	
			1 - 9	10 +
CDCK0601	6/4 mm	1/8" BSPT	£1.25	£1.13
CDCK0602	6/4 mm	1/4" BSPT	£1.36	£1.22
CDCK0801	8/5.5 mm	1/8" BSPT	£1.36	£1.22
CDCK0802	8/5.5 mm	1/4" BSPT	£1.68	£1.51
CDCK0803	8/5.5 mm	3/8" BSPT	£1.89	£1.70
CDCK1002	10/6.5 mm	1/4" BSPT	£1.99	£1.79
CDCK1003	10/6.5 mm	3/8" BSPT	£1.99	£1.79
CDCK1202	12/8 mm	1/4" BSPT	£1.99	£1.79
CDCK1203	12/8 mm	3/8" BSPT	£1.99	£1.79



GCK
ELBOW

3700

PART NUMBER	TUBE OD/ID	THREAD	PRICE EACH	
			1 - 9	10 +
CDGCK0601	6/4 mm	1/8" BSPT	£1.68	£1.51
CDGCK0602	6/4 mm	1/4" BSPT	£1.89	£1.70
CDGCK0801	8/5.5 mm	1/8" BSPT	£1.68	£1.51
CDGCK0802	8/5.5 mm	1/4" BSPT	£1.89	£1.70
CDGCK0803	8/5.5 mm	3/8" BSPT	£2.41	£2.17
CDGCK1002	10/6.5 mm	1/4" BSPT	£2.62	£2.36
CDGCK1003	10/6.5 mm	3/8" BSPT	£2.62	£2.36
CDGCK1202	12/8 mm	1/4" BSPT	£2.63	£2.36
CDGCK1203	12/8 mm	3/8" BSPT	£2.62	£2.36

BLOW GUN

SPECIFICATIONS

Temperature range	0°C to +60°C (+32°F to +140°F)
Working pressure	0 - 150 psi



BLOW GUN
WITH 100 MM TUBE

3760

PART NUMBER	THREAD	PRICE EACH	
		1 - 9	10 +
CDCB01-100G	1/4" BSP	£10.75	£9.67

PRODUCT FEATURES

- Flexible coolant hose system
- Dimensionally stable through tight fitting components. Will not alter under pressure or machine vibrations
- Resistant to chemicals and solvents, non-conductive
- Compatible with competitive systems
- Coolant nozzles are ideally suited for positioning and distributing fluids and air
- Good tolerance to corrosion and chemicals
- Good anti-conductivity
- Variable flow direction
- Lightweight

APPLICATIONS

Cooling and cleaning in the following industries:

- Sawing
- Drilling
- Turning
- Milling
- Grinding

WORKING PRESSURE

Maximum flow rate: 16 l/min (to avoid hose jetting)
 Pressure rating: 2 – 3 bar (30 – 50 psi)
 Inside diameter: 1/4"

MATERIALS

Made from plastics to be semi permanent and lightweight.

DIMENSIONS

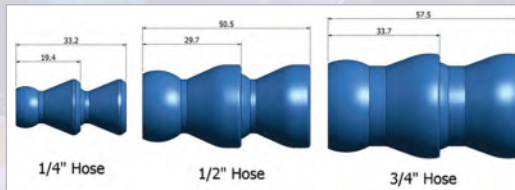

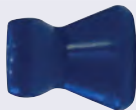

SINGLE KNUCKLE JOINT

3760

PART NUMBER	KNUCKLE JOINT	PRICE
CDOEL04-H04	1/4"	£1.11
CDOEL08-H08	1/2"	£1.63
CDOEL12-H12	3/4"	£2.67



BALL VALVE WITH KNUCKLE JOINT

3760

PART NUMBER	BALL VALVE	KNUCKLE JOINT	PRICE
CDOEL04-V04	1/4"	1/4"	£13.03
CDOEL08-V08	1/2"	1/2"	£18.12



BSPT MALE WITH KNUCKLE JOINT

3760

PART NUMBER	MALE THREAD	KNUCKLE JOINT	PRICE
CDOEL04-PT02	1/8" BSPT	1/4"	£0.96
CDOEL04-PT04	1/4" BSPT	1/4"	£1.16
CDOEL08-PT06	3/8" BSPT	1/2"	£1.34
CDOEL08-PT08	1/2" BSPT	1/2"	£1.83
CDOEL12-PT12	3/4" BSPT	3/4"	£5.33



Y JUNCTION WITH KNUCKLE JOINT

3760

PART NUMBER	Y JUNCTION	KNUCKLE JOINT	PRICE
CDOEL04-YF04	2 x	1/4"	£7.90
CDOEL08-YF08	2 x	1/2"	£9.13



ROUND NOZZLE WITH KNUCKLE JOINT

3760

PART NUMBER	NOZZLE	KNUCKLE JOINT	PRICE
CDOEL04-RN02	1/8"	1/4"	£1.02
CDOEL04-RN04	1/4"	1/4"	£1.26
CDOEL08-RN04	1/4"	1/2"	£1.26
CDOEL08-RN06	3/8"	1/2"	£2.70
CDOEL12-RN10	5/8"	3/4"	£5.33

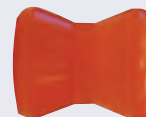

DOUBLE UNION WITH KNUCKLE JOINT

3760

PART NUMBER	KNUCKLE JOINT	PRICE
CDOEL04-DS04	1/4"	£4.26
CDOEL08-DS08	1/2"	£4.87



FAN NOZZLE WITH KNUCKLE JOINT

3760

PART NUMBER	NOZZLE	KNUCKLE JOINT	PRICE
CDOEL04-FN16	1"	1/4"	£1.67
CDOEL08-FN20	1 1/4"	1/2"	£6.66
CDOEL08-FN40	2"	1/2"	£8.16
CDOEL12-FN48	3"	3/4"	£14.65



REDUCING Y JUNCTION WITH KNUCKLE JOINT

3760

PART NUMBER	Y JUNCTION	KNUCKLE JOINT	PRICE
CDOEL08-YR0804	2 x 1/4"	1/2"	£9.13



16 HOLE FAN NOZZLE WITH KNUCKLE JOINT

3760

PART NUMBER	HOLE DIAMETER	KNUCKLE JOINT	PRICE
CDOEL04-16HN-1MM	1.0 mm	1/4"	£13.32
CDOEL04-16HN-1.5MM	1.5 mm	1/4"	£13.32



PLIERS

3760

PART NUMBER	DESCRIPTION	PRICE
CDOELP1418	1/4"	£161.00
CDOELP1238	1/2"	£161.00
CDOELP34	3/4"	£161.00

SUITABILITY	FEATURES / BENEFITS
<ul style="list-style-type: none"> Compressed air Vacuum Chemicals Oil 	<ul style="list-style-type: none"> Excellent flexibility at low pressure Lightweight with good tolerance to wear and chemicals Convenient for piping, as it has better flexibility than nylon tube
SPECIFICATIONS	
Temperature range	0°C to +60°C
Pressure rating	Vacuum 28" Hg Values given are based on the short term burst pressure of CDPU hose at 20°C using a 3:1 safety factor. NOTE: Any increase in temperature above 20°C will result in a decline in the working pressure values.
Construction	Colours – Polyester based PU Shore A 98 Clear – Polyester based PU Shore A 96 Ester based



Supplied on drums in full 100 m coils

CDPU – CLEAR 100 METRE COILS

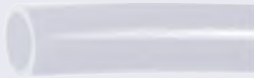

3755

PART NUMBER	mm	mm	bar	PRICE per coil
CDPU0425CLR	4.0	2.5	10	£51.70
CDPU0640CLR	6.0	4.0	10	£78.10
CDPU0850CLR	8.0	5.0	10	£122.58
CDPU0855CLR	8.0	5.5	10	£113.17
CDPU1065CLR	10.0	6.5	10	£155.99
CDPU1280CLR	12.0	8.0	10	£208.47

CDPU – RED 100 METRE COILS



3755

PART NUMBER	mm	mm	bar	PRICE per coil
CDPU0425RED	4.0	2.5	10	£51.70
CDPU0640RED	6.0	4.0	10	£78.10
CDPU0850RED	8.0	5.0	10	£122.58
CDPU0855RED	8.0	5.5	10	£113.17
CDPU1065RED	10.0	6.5	10	£155.99
CDPU1280RED	12.0	8.0	10	£208.47

CDPU – BLUE 50 METRE COILS



3755

PART NUMBER	mm	mm	bar	PRICE per coil
CDPU1410BLU	14.0	10.0	10	£190.84
CDPU1611BLU	16.0	11.0	10	£353.30
CDPU1612BLU	16.0	12.0	10	£278.23

100 METRE COILS

CDPU0425BLU	4.0	2.5	10	£51.70
CDPU0640BLU	6.0	4.0	10	£78.10
CDPU0850BLU	8.0	5.0	10	£122.58
CDPU0855BLU	8.0	5.5	10	£113.17
CDPU1065BLU	10.0	6.5	10	£155.99
CDPU1280BLU	12.0	8.0	10	£208.47
CDPU1290BLU	12.0	9.0	10	£181.84

200 METRE COILS

CDPU0320BLU	3.0	2.0	10	£58.17
-------------	-----	-----	----	--------

CDPU – BLACK 100 METRE COILS



3755

PART NUMBER	mm	mm	bar	PRICE per coil
CDPU0425BLK	4.0	2.5	10	£51.70
CDPU0640BLK	6.0	4.0	10	£78.10
CDPU0850BLK	8.0	5.0	10	£122.58
CDPU0855BLK	8.0	5.5	10	£113.17
CDPU1065BLK	10.0	6.5	10	£155.99
CDPU1280BLK	12.0	8.0	10	£208.47

CDPU – YELLOW 100 METRE COILS



3755

PART NUMBER	mm	mm	bar	PRICE per coil
CDPU0425YEL	4.0	2.5	10	£51.70
CDPU0640YEL	6.0	4.0	10	£78.10
CDPU0850YEL	8.0	5.0	10	£122.58
CDPU0855YEL	8.0	5.5	10	£113.17
CDPU1065YEL	10.0	6.5	10	£155.99
CDPU1280YEL	12.0	8.0	10	£208.47

CDPU – GREEN 100 METRE COILS



3755

PART NUMBER	mm	mm	bar	PRICE per coil
CDPU0425GRN	4.0	2.5	10	£51.70
CDPU0640GRN	6.0	4.0	10	£78.10
CDPU0850GRN	8.0	5.0	10	£122.58
CDPU0855GRN	8.0	5.5	10	£113.17
CDPU1065GRN	10.0	6.5	10	£155.99
CDPU1280GRN	12.0	8.0	10	£208.47

CDPU – TRANSPARENT BLUE 100 METRE COILS



3755

PART NUMBER	mm	mm	bar	PRICE per coil
CDPU0425TB	4.0	2.5	10	£51.70
CDPU0640TB	6.0	4.0	10	£78.10
CDPU0855TB	8.0	5.5	10	£113.17
CDPU1065TB	10.0	6.5	10	£155.99
CDPU1280TB	12.0	8.0	10	£208.47

SUITABILITY	FEATURES / BENEFITS
<ul style="list-style-type: none"> Compressed air Vacuum Chemicals Oil 	<ul style="list-style-type: none"> Excellent flexibility at low pressure Lightweight with good tolerance to wear and chemicals Convenient for piping, as it has better flexibility than nylon tube
SPECIFICATIONS	
Temperature range	0°C to +60°C
Pressure rating	Vacuum 28" Hg Values given are based on the short term burst pressure of CDPU hose at 20°C using a 3:1 safety factor. NOTE: Any increase in temperature above 20°C will result in a decline in the working pressure values.
Construction	Colours – Polyester based PU Shore A 98 Clear – Polyester based PU Shore A 96 Ester based



Supplied boxed in full 25 m coils

CDPU – CLEAR 25 METRE COILS



3755

PART NUMBER	mm	mm	bar	PRICE per coil
CDPU0425CLR25	4.0	2.5	10	£14.98
CDPU0640CLR25	6.0	4.0	10	£22.45
CDPU0850CLR25	8.0	5.0	10	£33.31
CDPU0855CLR25	8.0	5.5	10	£32.83
CDPU1065CLR25	10.0	6.5	10	£48.74
CDPU1280CLR25	12.0	8.0	10	£64.72

CDPU – RED 25 METRE COILS



3755

PART NUMBER	mm	mm	bar	PRICE per coil
CDPU0425RED25	4.0	2.5	10	£14.98
CDPU0640RED25	6.0	4.0	10	£22.45
CDPU0850RED25	8.0	5.0	10	£33.31
CDPU0855RED25	8.0	5.5	10	£32.83
CDPU1065RED25	10.0	6.5	10	£48.74
CDPU1280RED25	12.0	8.0	10	£64.72

New Additions

CDPU – BLUE 25 METRE COILS



3755

PART NUMBER	mm	mm	bar	PRICE per coil
CDPU0320BLU25	3.0	3.0	10	£14.54
CDPU0425BLU25	4.0	2.5	10	£14.98
CDPU0640BLU25	6.0	4.0	10	£22.45
CDPU0850BLU25	8.0	5.0	10	£33.31
CDPU0855BLU25	8.0	5.5	10	£32.83
CDPU1065BLU25	10.0	6.5	10	£48.74
CDPU1280BLU25	12.0	8.0	10	£64.72

CDPU – YELLOW 25 METRE COILS

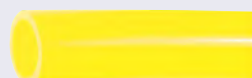

3755

PART NUMBER	mm	mm	bar	PRICE per coil
CDPU0425YEL25	4.0	2.5	10	£14.98
CDPU0640YEL25	6.0	4.0	10	£22.45
CDPU0850YEL25	8.0	5.0	10	£33.31
CDPU0855YEL25	8.0	5.5	10	£32.83
CDPU1065YEL25	10.0	6.5	10	£48.74
CDPU1280YEL25	12.0	8.0	10	£64.72

CDPU – BLACK 25 METRE COILS



3755

PART NUMBER	mm	mm	bar	PRICE per coil
CDPU0425BLK25	4.0	2.5	10	£14.98
CDPU0640BLK25	6.0	4.0	10	£22.45
CDPU0850BLK25	8.0	5.0	10	£33.31
CDPU0855BLK25	8.0	5.5	10	£32.83
CDPU1065BLK25	10.0	6.5	10	£48.74
CDPU1280BLK25	12.0	8.0	10	£64.72

CDPU – GREEN 25 METRE COILS



3755

PART NUMBER	mm	mm	bar	PRICE per coil
CDPU0425GRN25	4.0	2.5	10	£14.98
CDPU0640GRN25	6.0	4.0	10	£22.45
CDPU0850GRN25	8.0	5.0	10	£33.31
CDPU0855GRN25	8.0	5.5	10	£32.83
CDPU1065GRN25	10.0	6.5	10	£48.74
CDPU1280GRN25	12.0	8.0	10	£64.72

CDPU – TRANSPARENT BLUE 25 METRE COILS



3755

PART NUMBER	mm	mm	bar	PRICE per coil
CDPU0425TB25	4.0	2.5	10	£14.98
CDPU0640TB25	6.0	4.0	10	£22.45
CDPU0855TB25	8.0	5.5	10	£32.83
CDPU1065TB25	10.0	6.5	10	£48.74
CDPU1280TB25	12.0	8.0	10	£64.72

SUITABILITY	FEATURES / BENEFITS
<ul style="list-style-type: none"> Compressed air Vacuum Chemicals Oil 	<ul style="list-style-type: none"> Excellent flexibility at low temperature Light-weight with good tolerance to wear and chemicals Convenient for piping, as it has better flexibility than nylon tube
SPECIFICATIONS	
Temperature range	0°C to +60°C
Pressure rating	Vacuum 28" Hg. Values given are based on the short term burst pressure of CDUC hose at 20°C using a 3:1 safety factor. NOTE: Any increase in temperature above 20°C will result in a decline in the working pressure values
Construction	Polyester based PU Shore A 98



RECOIL WITH FIXED NIPPLE AND SPRING

RECOIL WITHOUT NIPPLE AND SPRING

CDUC WITH BSPT FIXED NIPPLE – YELLOW

43 MM MANDREL SIZE



3757

PART NUMBER	mm	mm	mtrs	BSPT	PRICE per recoil
CDUC0805Y-5	8.0	5.0	5.0	1/4	£19.18
CDUC0805Y75	8.0	5.0	7.5	1/4	£21.47
CDUC0805Y10	8.0	5.0	10.0	1/4	£25.39
CDUC1065Y-5	10.0	6.5	5.0	1/4	£21.45
CDUC1065Y75	10.0	6.5	7.5	1/4	£25.67
CDUC1065Y10	10.0	6.5	10.0	1/4	£29.06

CDUC – YELLOW

43 MM MANDREL SIZE



3757

PART NUMBER	mm	mm	mtrs	PRICE per recoil
CDUCB0604Y-3	6.0	4.0	3.0	£14.09
CDUCB0604Y-5	6.0	4.0	5.0	£15.66

60 MM MANDREL SIZE

CDUC1208Y-5	12.0	8.0	5.0	3/8	£25.38
CDUC1208Y75	12.0	8.0	7.5	3/8	£30.13
CDUC1208Y10	12.0	8.0	10.0	3/8	£35.52

CDUC WITH BSPT FIXED NIPPLE – RED

43 MM MANDREL SIZE



3757

PART NUMBER	mm	mm	mtrs	BSPT	PRICE per recoil
CDUC0805R-5	8.0	5.0	5.0	1/4	£19.18
CDUC0805R75	8.0	5.0	7.5	1/4	£21.47
CDUC0805R10	8.0	5.0	10.0	1/4	£25.39
CDUC1065R-5	10.0	6.5	5.0	1/4	£21.45
CDUC1065R75	10.0	6.5	7.5	1/4	£25.67
CDUC1065R10	10.0	6.5	10.0	1/4	£29.06

CDUC – RED

43 MM MANDREL SIZE



3757

PART NUMBER	mm	mm	mtrs	PRICE per recoil
CDUCB0604R-3	6.0	4.0	3.0	£14.09
CDUCB0604R-5	6.0	4.0	5.0	£15.66

60 MM MANDREL SIZE

CDUC1208R-5	12.0	8.0	5.0	3/8	£25.38
CDUC1208R75	12.0	8.0	7.5	3/8	£30.13
CDUC1208R10	12.0	8.0	10.0	3/8	£35.52

CDUC WITH BSPT FIXED NIPPLE – BLUE

43 MM MANDREL SIZE



3757

PART NUMBER	mm	mm	mtrs	BSPT	PRICE per recoil
CDUC0805B-5	8.0	5.0	5.0	1/4	£19.18
CDUC0805B75	8.0	5.0	7.5	1/4	£21.47
CDUC0805B10	8.0	5.0	10.0	1/4	£25.39
CDUC1065B-5	10.0	6.5	5.0	1/4	£21.45
CDUC1065B75	10.0	6.5	7.5	1/4	£25.67
CDUC1065B10	10.0	6.5	10.0	1/4	£29.06

CDUC – BLUE

43 MM MANDREL SIZE

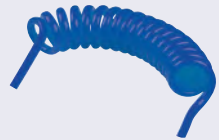

3757

PART NUMBER	mm	mm	mtrs	PRICE per recoil
CDUCB0604B-3	6.0	4.0	3.0	£14.09
CDUCB0604B-5	6.0	4.0	5.0	£15.66

60 MM MANDREL SIZE

CDUC1208B-5	12.0	8.0	5.0	3/8	£25.38
CDUC1208B75	12.0	8.0	7.5	3/8	£30.13
CDUC1208B10	12.0	8.0	10.0	3/8	£35.52

SPECIFICATIONS

Temperature range	-2°C to +66°C
Maximum pressure	4 mm, 5 mm, 6 mm = 230 psi 8 mm, 10 mm, 12 mm = 170 psi NOTE: Any increase in temperature above 20°C will result in a decline in the working pressure values
Tube tolerance	+0.1 mm/-0.1 mm

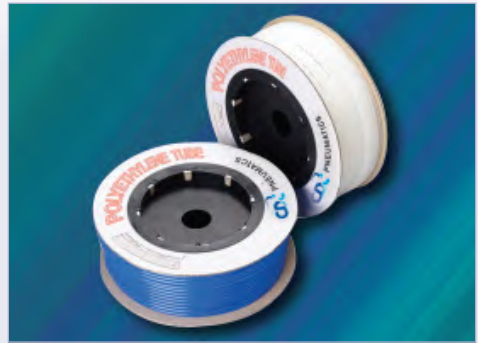

Supplied on drums in full coils only

PE – BLUE 100 METRES



3770

PART NUMBER	mm	mm	bar	PRICE per coil
CDPE0640BLU	6	4.0	15	£32.76
CDPE0860BLU	8	6.0	11	£46.37
CDPE1070BLU	10	7.0	11	£69.30
CDPE1290BLU	12	9.0	11	£87.70

200 METRES

CDPE0425BLU	4	2.5	15	£37.80
-------------	---	-----	----	--------

PE – BLACK 100 METRES



3770

PART NUMBER	mm	mm	bar	PRICE per coil
CDPE0640BLK	6	4.0	15	£32.76
CDPE0860BLK	8	6.0	11	£46.37
CDPE1070BLK	10	7.0	11	£69.30
CDPE1290BLK	12	9.0	11	£87.70

200 METRES

CDPE0425BLK	4	2.5	15	£37.80
-------------	---	-----	----	--------

PE – CLEAR 100 METRES

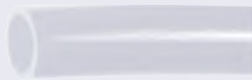

3770

PART NUMBER	mm	mm	bar	PRICE per coil
CDPE0640CLR	6	4.0	15	£32.76
CDPE0860CLR	8	6.0	11	£46.37
CDPE1070CLR	10	7.0	11	£69.30
CDPE1290CLR	12	9.0	11	£87.70

200 METRES

CDPE0425CLR	4	2.5	15	£37.80
-------------	---	-----	----	--------

PE – RED 100 METRES



3770

PART NUMBER	mm	mm	bar	PRICE per coil
CDPE0640RED	6	4.0	15	£32.76
CDPE0860RED	8	6.0	11	£46.37
CDPE1070RED	10	7.0	11	£69.30
CDPE1290RED	12	9.0	11	£87.70

200 METRES

CDPE0425RED	4	2.5	15	£37.80
-------------	---	-----	----	--------

PE – WHITE 100 METRES



3770

PART NUMBER	mm	mm	bar	PRICE per coil
CDPE0640WHT	6	4.0	15	£32.76
CDPE0860WHT	8	6.0	11	£46.37
CDPE1070WHT	10	7.0	11	£69.30
CDPE1290WHT	12	9.0	11	£87.70

200 METRES

CDPE0425WHT	4	2.5	15	£37.80
-------------	---	-----	----	--------

ACCESSORIES

New Additions

TUBE CUTTER



3770

PART NUMBER	DESCRIPTION	PRICE
CDETC20	Cuts up to 3/4" (20 mm) tubing	£8.09
CDETC-B	Replacement blades Pack of 10	£24.27