



VALVOLE ACQUA
WATER VALVES
KUGELHÄHNE FÜR WASSER
VANNES EAU
ЗАПОРНАЯ АРМАТУРА ДЛЯ ВОДЫ



Valvole in ottone per acqua Brass water valves



Top

p. 137

Export Plus

p. 139



Everlast Plus

p. 149

Everlast

p. 150

Everwater Plus

p. 158

Everwater

p. 159



Evermid

p. 164

Elite GW 4MS

p. 172

Elite GW 4MS Kiwa

p. 175



Solar Line

p. 178

NPT

p. 181

DZR

p. 182

Nordika

p. 185



Valvola con bocchettone - Valve with tail piece

p. 187

Valvola a sfera con portasonda - Ball valves with sensor connection

p. 188

Valvola a sfera a tre - 3-way valve

p. 191



Valvole attacco pompa - Valves for pump connection

p. 193

Valvole di ritegno e raccoglitori di impurità - Check valves and strainers

p. 202

Saracinesche - Gate valves

p. 206

Riduttori di pressione - Pressure reducing valves

p. 208



Raccordi - Fittings

p. 210

Filtro autopulente - Self-cleaning filter

p. 216

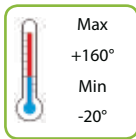

IVR TOP

IVR 48 TOP



Valvola a sfera a passaggio totale - attacchi F/F
Full bore ball valve - threaded ends F/F
Kugelhahn mit vollem Durchgang - IG/IG
Vanne à boisseau sphérique à passage intégral - Fixations F/F
Полнопроходной шаровой кран - Соединения В/В

Cod./Code	DN	Ø	□/田	€
104803024	3/8"	10	10/120	
104805024	1/2"	15	5/60	
104807024	3/4	20	15/60	
104810024	1"	25	10/40	
104812024	1"1/4	32	4/16	
104815024	1"1/2	40	4/16	
104820024	2"	50	2/8	



IVR 48/A TOP



Valvola a sfera a passaggio totale - attacchi F/F
Full bore ball valve - threaded ends F/F
Kugelhahn mit vollem Durchgang - IG/IG
Vanne à boisseau sphérique à passage intégral - fixations F/F
Полнопроходной шаровой кран - Соединения В/В

Cod./Code	DN	Ø	□/田	€
104803021	3/8"	10	10/120	
104805021	1/2"	15	5/60	
104807021	3/4	20	15/60	
104810021	1"	25	10/40	



IVR 49 TOP



Valvola a sfera a passaggio totale - attacchi M/F
Full bore ball valve - threaded ends M/F
Kugelhahn mit vollem Durchgang - AG/IG
Vanne à boisseau sphérique à passage intégral - fixations M/F
Полнопроходной шаровой кран - Соединения Н/В

Cod./Code	DN	Ø	□/田	€
104903024	3/8"	10	10/120	
104905024	1/2"	15	5/60	
104907024	3/4	20	15/60	
104910024	1"	25	10/40	
104912024	1"1/4	32	4/16	
104915024	1"1/2	40	4/16	
104920024	2"	50	2/8	



IVR 49/A TOP



Valvola a sfera a passaggio totale - attacchi M/F
Full bore ball valve - threaded ends M/F
Kugelhahn mit vollem Durchgang - AG/IG
Vanne à boisseau sphérique à passage intégral - fixations M/F
Полнопроходной шаровой кран - Соединения Н/В

Cod./Code	DN	Ø	□/田	€
104903021	3/8"	10	10/120	
104905021	1/2"	15	5/60	
104907021	3/4	20	15/60	
104910021	1"	25	10/40	



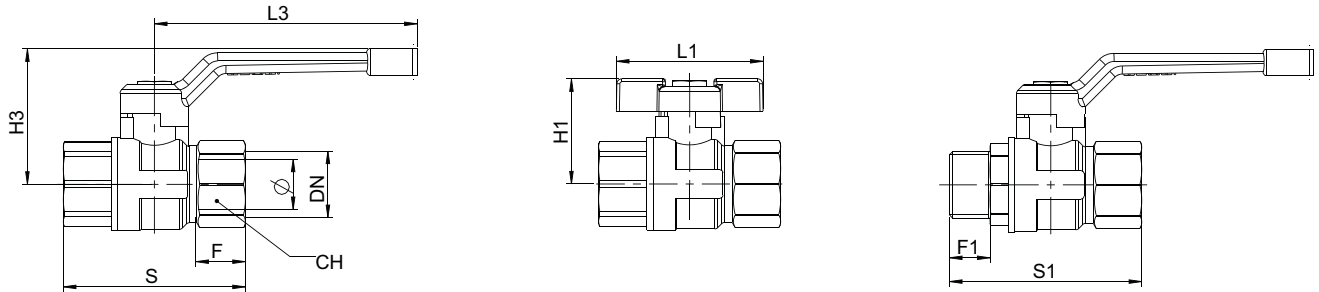

TOP															
DIMENSIONI / DIMENSIONS															
DN	Ø	S	S1	S2	L	L1	L2	L3	H	H1	H2	H3	F	F1	CH
3/8"	10	60	61			50		85		33		44	19	12	22
1/2"	15	75	76			61		110		39		52	23	15	26
3/4"	20	80	85			61		110		43		55	23,5	17	31
1"	25	90	95			72		130		52		67	24,5	20	40
1"1/4	32	110	111					130				72	31	22,5	49
1"1/2	40	120	125					160				90	32	22,5	55
2"	50	141	144					160				95	36	26,5	68

TOP						
ACCESSORI / RICAMBI - ACCESSORIES / SPARE PARTS						
3/8"	700702001	703002001	750106001	125603440	125603600	109702030
1/2"	700712001	703012001	750108001	125605440	125605600	109705030
3/4"	700712001	703012001	750108001	125605440	125605600	109705030
1"	700722001	703022001	750110001	125610440	125610600	109710030
1"1/4	700722001		750110001	125610440	125610600	109710030
1"1/2	700732001		750114001	125615440	125615600	109715030
2"	700732001		750114001	125615440	125615600	109715030

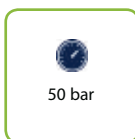

50 bar

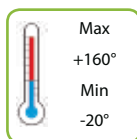

Max
+160°
Min
-20°



UNI ISO 228-1

IVR EXPORT PLUS

IVR 45 PLUS



Valvola a sfera a passaggio totale - attacchi F/F

Full bore ball valve - threaded ends F/F

Kugelhahn mit vollem Durchgang - IG/IG

Vanne à boisseau sphérique à passage intégral - fixations F/F

Полнопроходной шаровой кран - Соединения В/В

Cod./Code	DN	Ø	□/田	€
104502851	1/4"	10	10/120	
104503851	3/8"	10	10/120	
104505851	1/2"	15	12/72	
104507851	3/4"	20	20/80	
104510851	1"	25	12/48	
104512851	1"1/4	32	6/24	
104515851	1"1/2	40	4/16	
104520851	2"	50	2/8	
104525487	2" 1/2	61	6	(*)
104530487	3"	74	4	(*)
104540487	4"	95	2	(*)



- (*) Maniglia imbutita in acciaio
- (*) Steel drawn handle
- (*) Tiefgezogener Griff aus Stahl
- (*) Poignée emboutie en acier
- (*) Штампованная стальная ручка

IVR 46 PLUS



Valvola a sfera a passaggio totale - attacchi M/F

Full bore ball valve - threaded ends M/F

Kugelhahn mit vollem Durchgang - AG/IG

Vanne à boisseau sphérique à passage intégral - fixations M/F

Полнопроходной шаровой кран - Соединения Н/В

Cod./Code	DN	Ø	□/田	€
104602851	1/4"	10	10/120	
104603851	3/8"	10	10/120	
104605851	1/2"	15	12/72	
104607851	3/4"	20	15/60	
104610851	1"	25	12/48	
104612851	1"1/4	32	6/24	
104615851	1"1/2	40	4/16	
104620851	2"	50	2/8	



IVR 47 PLUS



Valvola a sfera a passaggio totale - attacchi M/M

Full bore ball valve - threaded ends M/M

Kugelhahn mit vollem Durchgang - AG/AG

Vanne à boisseau sphérique à passage intégral - fixations M/M

Полнопроходной шаровой кран - Соединения Н/Н

Cod./Code	DN	Ø	□/田	€
104703851	3/8"	10	10/120	
104705851	1/2"	15	12/72	
104707851	3/4"	20	10/40	
104710851	1"	25	12/48	



IVR 52 SFERA INOX



Valvola a sfera a passaggio totale - sfera acciaio inox AISI 304 - attacchi F/F
Full bore ball valve - ball in s.s. AISI 304 - stainless steel ball - threaded ends F/F
Kugelhahn mit vollem Durchgang - Kugel aus rostfreiem Edelstahl AISI 304 - IG/IG
Vanne à boisseau sphérique à passage intégral - Sphère acier inox AISI 304 - fixations F/F
Полнопроходной шаровой кран - шар из нержавеющей стали AISI 304 - соединения В/В

Cod./Code	DN	Ø	□/田	€
105202001	1/4"	10	10/120	
105203001	3/8"	10	10/120	
105205001	1/2"	15	12/72	
105207001	3/4"	20	20/80	
105210001	1"	25	12/48	
105212001	1"1/4	32	6/24	
105215001	1"1/2	40	4/16	
105220001	2"	50	2/8	

EAC

IVR 52/A SFERA INOX



Valvola a sfera a passaggio totale - sfera acciaio inox AISI 304 - attacchi F/F
Full bore ball valve - AISI 304 stainless steel ball - threaded ends F/F
Kugelhahn mit vollem Durchgang - Kugel aus rostfreiem Edelstahl AISI 304 - IG/IG
Vanne à boisseau sphérique à passage intégral - Sphère acier inox AISI 304 - fixations F/F
Полнопроходной шаровой кран - шар из нержавеющей стали AISI 304 - соединения В/В

Cod./Code	DN	Ø	□/田	€
105202002	1/4"	10	10/120	
105203002	3/8"	10	10/120	
105205002	1/2"	15	12/72	
105207002	3/4"	20	20/80	
105210002	1"	25	12/48	

EAC



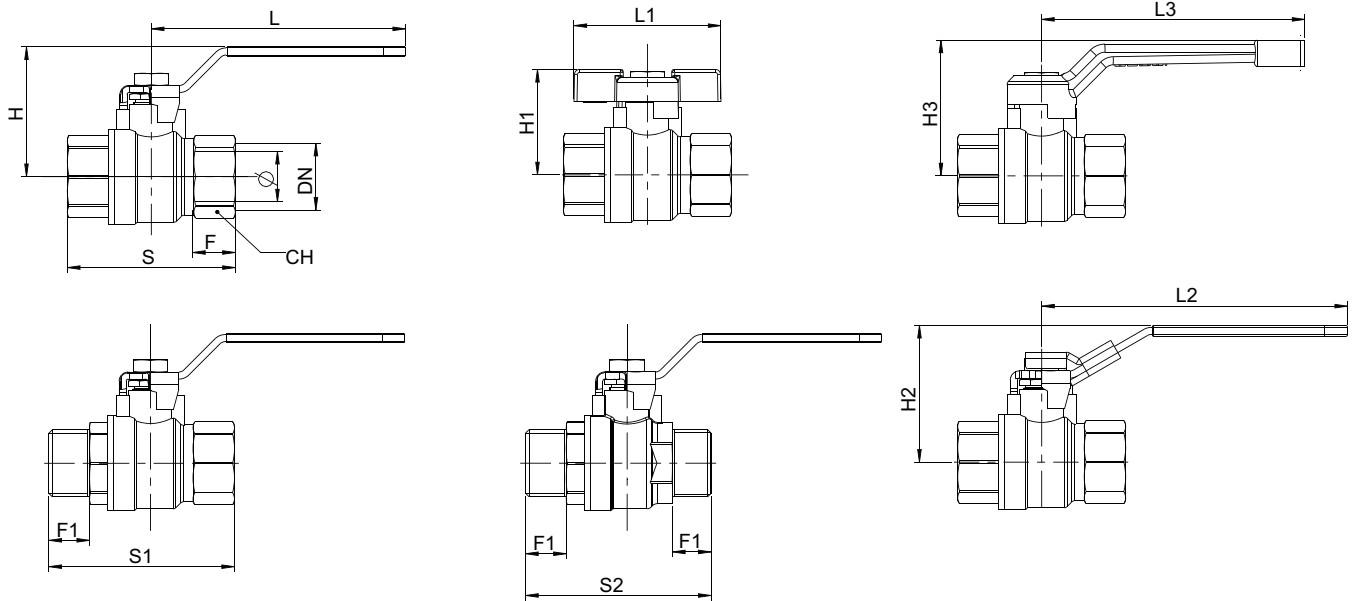

EXPORT		DIMENSIONI / DIMENSIONS													
DN	Ø	S	S1	S2	L	L1	L2	L3	H	H1	H2	H3	F	F1	CH
1/4"	10	45	42	52	80	50	95	85	40	33	43	44	12	10	21
3/8"	10	45	54	54	80	50	95	85	40	33	44	44	12	12	21
1/2"	15	63	70	68	90	61	120	110	52	39	56	52	17	15	26
3/4"	20	71	80	77	90	61	120	110	55	43	60	55	19,5	16	31
1"	25	83	92	92	125	72	150	130	64	52	68	67	21	19	38
1 1/4"	32	92	102		125		150	130	69	57	73	72	22	20,5	48
1 1/2"	40	104	117		140		160	160	78		87	88	23,5	21,5	55
2"	50	124	137		140		160	160	85		94	95	28	24,5	68
2 1/2"	60	140			250			160	131				28		85
3"	74	159			250			160	140				30,5		99
4"	94	196			250			160	154				38		125

EXPORT		ACCESSORI / RICAMBI - ACCESSORIES / SPARE PARTS									
1/4"	700702001	700101001	700105001	700102001	703001501	703005001	703002001	750106001	125603440	125603600	109702030
3/8"	700702001	700101001	700105001	700102001	703001501	703005001	703002001	750106001	125603440	125603600	109702030
1/2"	700712001	700111001	700115001	700112001	703011501	703015001	703012001	750108001	125605440	125605600	109705030
3/4"	700712001	700111001	700115001	700112001	703011501	703015001	703012001	750108001	125605440	125605600	109705030
1"	700722001	700121001	700125001	700122001	703021501	703025001	703022001	750110001	125610440	125610600	109710030
1 1/4"	700722001	700121001	700125001	700122001				750110001	125610440	125610600	109710030
1 1/2"	700732001	700131001	700135001	700132001				750114001	125615440	125615600	109715030
2"	700732001	700131001	700135001	700132001				750114001	125615440	125615600	109715030
2 1/2"	701052001	700151001	700155001	700152001				750118001			109725010
3"	701052001	700151001	700155001	700152001				750118001			109725010
4"	701052001	700151001	700155001	700152001				750118001			109725010

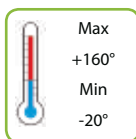
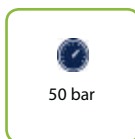

IVR EVERLAST PLUS

IVR 954 PLUS



- (*) Maniglia imbutita in acciaio
- (*) Steel drawn handle
- (*) Tiefgezogener Griff aus Stahl
- (*) Poignée emboutie en acier
- (*) Штампованная стальная ручка



Valvola a sfera a passaggio totale - attacchi F/F
Full bore ball valve - threaded ends F/F
Kugelhahn mit vollem Durchgang - IG/IG
Vanne à boisseau sphérique à passage intégral - fixations F/F
Полнопроходной шаровой кран - Соединения В/В

Cod./Code	DN	Ø	□/田	€
195402024	1/4"	10	10/120	
195403024	3/8"	10	10/120	
195405024	1/2"	15	20/120	
195407024	3/4"	20	20/80	
195410024	1"	25	12/48	
195412024	1"1/4	32	8/32	
195415024	1"1/2	40	6/24	
195420024	2"	50	4/16	
195425024	2" 1/2	61	8	(*)
195430024	3"	74	6	(*)
195440024	4"	95	2	(*)

IVR 956 PLUS



Valvola a sfera a passaggio totale - attacchi M/F
Full bore ball valve - threaded ends M/F
Kugelhahn mit vollem Durchgang - AG/IG
Vanne à boisseau sphérique à passage intégral - fixations M/F
Полнопроходной шаровой кран - Соединения Н/В

Cod./Code	DN	Ø	□/田	€
195602334	1/4"	10	10/120	
195603334	3/8"	10	10/120	
195605334	1/2"	15	20/120	
195607334	3/4"	20	20/80	
195610334	1"	25	12/48	
195612334	1"1/4	32	8/32	
195615334	1"1/2	40	6/24	
195620334	2"	50	4/16	

IVR 957 PLUS



Valvola a sfera a passaggio totale - attacchi M/M
Full bore ball valve - threaded ends M/M
Kugelhahn mit vollem Durchgang - AG/AG
Vanne à boisseau sphérique à passage intégral - fixations M/M
Полнопроходной шаровой кран - Соединения Н/Н

Cod./Code	DN	Ø	□/田	€
195702334	1/4"	10	10/120	
195703334	3/8"	10	10/120	
195705334	1/2"	15	20/120	
195707334	3/4"	20	20/80	
195710334	1"	25	10/40	
195712334	1"1/4	32	8/32	
195715334	1"1/2	40	6/24	
195720334	2"	50	4/16	

IVR EVERLAST

50 bar

Max
+160°
Min
-20°

UNI ISO 228-1

IVR 954



Valvola a sfera a passaggio totale - attacchi F/F, con maniglia rossa
Full bore ball valve - threaded ends F/F, with red handle
Kugelhahn mit vollem Durchgang - IG/IG, mit rotem Hebelgriff
Vanne à boisseau sphérique à passage intégral - fixations F/F, avec poignée rouge
Полнопроходной шаровой кран - Соединения В/В, с красной ручкой

Cod./Code	DN	Ø	□/田	€
195402007	1/4"	10	10/120	
195403007	3/8"	10	10/120	
195405007	1/2"	15	20/120	
195407007	3/4"	20	20/80	
195410007	1"	25	12/48	
195412007	1"1/4	32	8/32	
195415007	1"1/2	40	6/24	
195420007	2"	50	4/16	
195425007	2"1/2	61	8	
195430007	3"	74	6	
195440007	4"	95	2	



IVR 954 LB



Valvola a sfera a passaggio totale - attacchi F/F, con maniglia blu
Full bore ball valve - threaded ends F/F, with blue handle
Kugelhahn mit vollem Durchgang - IG/IG, mit blauem Hebelgriff
Vanne à boisseau sphérique à passage intégral - fixations F/F, avec poignée bleu
Полнопроходной шаровой кран - Соединения В/В, с голубой ручкой

Cod./Code	DN	Ø	□/田	€
195402209	1/4"	10	10/120	
195403209	3/8"	10	10/120	
195405209	1/2"	15	20/120	
195407209	3/4"	20	20/80	
195410209	1"	25	12/48	
195412209	1"1/4	32	8/32	
195415209	1"1/2	40	6/24	
195420209	2"	50	4/16	
195425209	2"1/2	61	8	
195430209	3"	74	6	
195440209	4"	95	2	



SU RICHIESTA
ON DEMAND



IVR 954 LN



Valvola a sfera a passaggio totale - attacchi F/F, con maniglia nera
Full bore ball valve - threaded ends F/F, with black handle
Kugelhahn mit vollem Durchgang - IG/IG, mit schwarzem Hebelgriff
Vanne à boisseau sphérique à passage intégral - fixations F/F, avec poignée noire
Полнопроходной шаровой кран - Соединения В/В, с чёрной ручкой

Cod./Code	DN	Ø	□/田	€
195402219	1/4"	10	10/120	
195403219	3/8"	10	10/120	
195405219	1/2"	15	20/120	
195407219	3/4"	20	20/80	
195410219	1"	25	12/48	
195412219	1"1/4	32	8/32	
195415219	1"1/2	40	6/24	
195420219	2"	50	4/16	
195425219	2"1/2	61	8	
195430219	3"	74	6	
195440219	4"	95	2	



SU RICHIESTA
ON DEMAND



IVR 954/A



Valvola a sfera a passaggio totale - attacchi F/F, con farfalla rossa
Full bore ball valve - threaded ends F/F, with red butterfly handle
Kugelhahn mit vollem Durchgang - IG/IG, mit rotem Flügelgriff
Vanne à boisseau sphérique à passage intégral - fixations F/F, avec papillon rouge
Полнопроходной шаровой кран - Соединения В/В, с красной ручкой "бабочка"

Cod./Code	DN	Ø	□/田	€
195402008	1/4"	10	10/120	
195403008	3/8"	10	10/120	
195405008	1/2"	15	20/120	
195407008	3/4"	20	20/80	
195410008	1"	25	12/48	
195412008	1"1/4	32	8/32	



IVR 954/A FB



Valvola a sfera a passaggio totale - attacchi F/F, con farfalla blu
Full bore ball valve - threaded ends F/F, with blue butterfly handle
Kugelhahn mit vollem Durchgang - IG/IG, mit blauem Flügelgriff
Vanne à boisseau sphérique à passage intégral - fixations F/F, avec papillon bleu
Полнопроходной шаровой кран - Соединения В/В, с голубой ручкой "бабочка"

Cod./Code	DN	Ø	□/田	€
195402211	1/4"	10	10/120	
195403211	3/8"	10	10/120	
195405211	1/2"	15	20/120	
195407211	3/4"	20	20/80	
195410211	1"	25	12/48	
195412211	1"1/4	32	8/32	



IVR 954/A FN



Valvola a sfera a passaggio totale - attacchi F/F, con farfalla nera
Full bore ball valve - threaded ends F/F, with black butterfly handle
Kugelhahn mit vollem Durchgang - IG/IG, mit schwarzem Flügelgriff
Vanne à boisseau sphérique à passage intégral - fixations F/F, avec papillon noire
Полнопроходной шаровой кран - Соединения В/В, с чёрной ручкой "бабочка"

Cod./Code	DN	Ø	□/田	€
195402335	1/4"	10	10/120	
195403335	3/8"	10	10/120	
195405335	1/2"	15	20/120	
195407335	3/4"	20	20/80	
195410335	1"	25	12/48	
195412335	1"1/4	32	8/32	



IVR 956



Valvola a sfera a passaggio totale - attacchi M/F, con maniglia rossa
 Full bore ball valve - threaded ends M/F, with red handle
 Kugelhahn mit vollem Durchgang - AG/IG, mit rotem Hebelgriff
 Vanne à boisseau sphérique à passage intégral - fixations M/F, avec poignée rouge
 Полнопроходной шаровой кран - Соединения Н/В, с красной ручкой

Cod./Code	DN	Ø	□/⊞	€
195602007	1/4"	10	10/120	
195603007	3/8"	10	10/120	
195605007	1/2"	15	20/120	
195607007	3/4"	20	20/80	
195610007	1"	25	12/48	
195612007	1"1/4	32	8/32	
195615007	1"1/2	40	6/24	
195620007	2"	50	4/16	



IVR 956 LB



Valvola a sfera a passaggio totale - attacchi M/F, con maniglia blu
 Full bore ball valve - threaded ends M/F, with blue handle
 Kugelhahn mit vollem Durchgang - AG/IG, mit blauem Hebelgriff
 Vanne à boisseau sphérique à passage intégral - fixations M/F, avec poignée bleu
 Полнопроходной шаровой кран - Соединения Н/В, с голубой ручкой

Cod./Code	DN	Ø	□/⊞	€
195602209	1/4"	10	10/120	
195603209	3/8"	10	10/120	
195605209	1/2"	15	20/120	
195607209	3/4"	20	20/80	
195610209	1"	25	12/48	
195612209	1"1/4	32	8/32	
195615209	1"1/2	40	6/24	
195620209	2"	50	4/16	



IVR 956 LN



Valvola a sfera a passaggio totale - attacchi M/F, con maniglia nera
 Full bore ball valve - threaded ends M/F, with black handle
 Kugelhahn mit vollem Durchgang - AG/IG, mit schwarzem Hebelgriff
 Vanne à boisseau sphérique à passage intégral - fixations M/F, avec poignée noire
 Полнопроходной шаровой кран - Соединения Н/В, с чёрной ручкой

Cod./Code	DN	Ø	□/⊞	€
195602219	1/4"	10	10/120	
195603219	3/8"	10	10/120	
195605219	1/2"	15	20/120	
195607219	3/4"	20	20/80	
195610219	1"	25	12/48	
195612219	1"1/4	32	8/32	
195615219	1"1/2	40	6/24	
195620219	2"	50	4/16	



IVR 956/A



Valvola a sfera a passaggio totale - attacchi M/F, con farfalla rossa
Full bore ball valve - threaded ends M/F, with red butterfly handle
Kugelhahn mit vollem Durchgang - AG/IG, mit rotem Flügelgriff
Vanne à boisseau sphérique à passage intégral - fixations M/F, avec papillon rouge
Полнопроходной шаровой кран - Соединения Н/В, с красной ручкой "бабочка"

Cod./Code	DN	Ø	□/田	€
195602008	1/4"	10	10/120	
195603008	3/8"	10	10/120	
195605008	1/2"	15	20/120	
195607008	3/4"	20	20/80	
195610008	1"	25	12/48	
195612008	1 1/4"	32	8/32	



IVR 956/A FB



Valvola a sfera a passaggio totale - attacchi M/F, con farfalla blu
Full bore ball valve - threaded ends M/F, with blue butterfly handle
Kugelhahn mit vollem Durchgang - AG/IG, mit blauem Flügelgriff
Vanne à boisseau sphérique à passage intégral - fixations M/F, avec papillon bleu
Полнопроходной шаровой кран - Соединения Н/В с голубой ручкой "бабочка"

Cod./Code	DN	Ø	□/田	€
195602211	1/4"	10	10/120	
195603211	3/8"	10	10/120	
195605211	1/2"	15	20/120	
195607211	3/4"	20	20/80	
195610211	1"	25	12/48	
195612211	1 1/4"	32	8/32	



IVR 956/A FN



Valvola a sfera a passaggio totale - attacchi M/F, con farfalla nera
Full bore ball valve - threaded ends M/F, with black butterfly handle
Kugelhahn mit vollem Durchgang - AG/IG, mit schwarzem Flügelgriff
Vanne à boisseau sphérique à passage intégral - fixations M/F, avec papillon noire
Полнопроходной шаровой кран - Соединения Н/В, с чёрной ручкой "бабочка"

Cod./Code	DN	Ø	□/田	€
195602335	1/4"	10	10/120	
195603335	3/8"	10	10/120	
195605335	1/2"	15	20/120	
195607335	3/4"	20	20/80	
195610335	1"	25	12/48	
195612335	1 1/4"	32	8/32	



IVR 957



Valvola a sfera a passaggio totale - attacchi M/M, con maniglia rossa
 Full bore ball valve - threaded ends M/M, with red handle
 Kugelhahn mit vollem Durchgang - AG/AG, mit rotem Hebelgriff
 Vanne à boisseau sphérique à passage intégral - fixations M/M, avec poignée rouge
 Полнопроходной шаровой кран - Соединения Н/Н, с красной ручкой

Cod./Code	DN	Ø	□/田	€
195702007	1/4"	10	10/120	
195703007	3/8"	10	10/120	
195705007	1/2"	15	20/120	
195707007	3/4"	20	20/80	
195710007	1"	25	10/40	
195712007	1*1/4	32	8/32	
195715007	1*1/2	40	6/24	
195720007	2"	50	4/16	



IVR 957 LB



Valvola a sfera a passaggio totale - attacchi M/M, con maniglia blu
 Full bore ball valve - threaded ends M/M, with blue handle
 Kugelhahn mit vollem Durchgang - AG/AG, mit blauem Hebelgriff
 Vanne à boisseau sphérique à passage intégral - fixations M/M, avec poignée bleu
 Полнопроходной шаровой кран - Соединения Н/Н, с голубой ручкой

Cod./Code	DN	Ø	□/田	€
195702209	1/4"	10	10/120	
195703209	3/8"	10	10/120	
195705209	1/2"	15	20/120	
195707209	3/4"	20	20/80	
195710209	1"	25	10/40	
195712209	1*1/4	32	8/32	
195715209	1*1/2	40	6/24	
195720209	2"	50	4/16	



IVR 957 LN



Valvola a sfera a passaggio totale - attacchi M/M, con maniglia nera
 Full bore ball valve - threaded ends M/M, with black handle
 Kugelhahn mit vollem Durchgang - AG/AG, mit schwarzem Hebelgriff
 Vanne à boisseau sphérique à passage intégral - fixations M/M, avec poignée noire
 Полнопроходной шаровой кран - Соединения Н/Н, с чёрной ручкой

Cod./Code	DN	Ø	□/田	€
195702219	1/4"	10	10/120	
195703219	3/8"	10	10/120	
195705219	1/2"	15	20/120	
195707219	3/4"	20	20/80	
195710219	1"	25	10/40	
195712219	1*1/4	32	8/32	
195715219	1*1/2	40	6/24	
195720219	2"	50	4/16	



IVR 957/A



Valvola a sfera a passaggio totale - attacchi M/M, con farfalla rossa
Full bore ball valve - threaded ends M/M, with red butterfly handle
Kugelhahn mit vollem Durchgang - AG/AG, mit rotem Flügelgriff
Vanne à boisseau sphérique à passage intégral - fixations M/M, avec papillon rouge
Полнопроходной шаровой кран - Соединения Н/Н, с красной ручкой "бабочка"

Cod./Code	DN	Ø	□/田	€
195702008	1/4"	10	10/120	
195703008	3/8"	10	10/120	
195705008	1/2"	15	20/120	
195707008	3/4"	20	20/80	
195710008	1"	25	10/40	



IVR 957/A FB



Valvola a sfera a passaggio totale - attacchi M/M, con farfalla blu
Full bore ball valve - threaded ends M/M, with blue butterfly handle
Kugelhahn mit vollem Durchgang - AG/AG, mit blauem Flügelgriff
Vanne à boisseau sphérique à passage intégral - fixations M/M, avec papillon bleu
Полнопроходной шаровой кран - Соединения Н/Н, с голубой ручкой "бабочка"

Cod./Code	DN	Ø	□/田	€
195702211	1/4"	10	10/120	
195703211	3/8"	10	10/120	
195705211	1/2"	15	20/120	
195707211	3/4"	20	20/80	
195710211	1"	25	10/40	

SU RICHIESTA
ON DEMAND



IVR 957/A FN



Valvola a sfera a passaggio totale - attacchi M/M, con farfalla nera
Full bore ball valve - threaded ends M/M, with black butterfly handle
Kugelhahn mit vollem Durchgang - AG/AG, mit schwarzem Flügelgriff
Vanne à boisseau sphérique à passage intégral - fixations M/M, avec papillon noire
Полнопроходной шаровой кран - Соединения Н/Н, с чёрной ручкой "бабочка"

Cod./Code	DN	Ø	□/田	€
195702335	1/4"	10	10/120	
195703335	3/8"	10	10/120	
195705335	1/2"	15	20/120	
195707335	3/4"	20	20/80	
195710335	1"	25	10/40	

SU RICHIESTA
ON DEMAND



IVR 954 LD



Valvola a sfera a passaggio totale - attacchi F/F con maniglia lucchettabile
Full bore ball valve - threaded ends F/F - with lockable handle
Kugelhahn mit vollem Durchgang - IG/IG- mit verriegelbarem Hebel
Vanne à boisseau sphérique à passage intégral - fixations F/F - avec poignée cadenassable
Полнопроходной шаровой кран - Соединения В/В - с запираемой ручкой

Cod./Code	DN	Ø	□/田	€
195402750	1/4"	10	10/120	
195403750	3/8"	10	10/120	
195405750	1/2"	15	20/120	
195407750	3/4"	20	20/80	
195410750	1"	25	12/48	
195412750	1"1/4	32	8/32	
195415750	1"1/2	40	6/24	
195420750	2"	50	4/16	



NOTA: Disponibile anche, con maniglia blu
NOTE: Available, with blue handle
ANMERKUNG: Erhältlich auch mit blauem Griff
NOTE: Disponible, avec poignée bleu
ПРИМЕЧАНИЕ: Доступен также с голубой ручкой

IVR 954/P

NEW



Valvola a sfera a passaggio totale - attacchi FF - con prolunga per coibentazione
Full bore ball valve - threaded ends F/F, with red handle - with isolation extension
Kugelhahn mit vollem Durchgang - IG/IG, mit rotem Hebelgriff - mit Isolierungsverlängerung
Vanne à boisseau sphérique à passage intégral - fixations F/F, avec poignée rouge - avec rallonge pour l'isolation
Полнопроходной шаровой кран - Соединения В/В, с красной ручкой - с удлинителем для изоляции

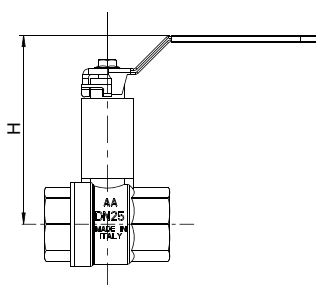

Cod./Code	DN	Ø	H	□/田	€
195405807	1/2"	15	87	15/60	
195407807	3/4"	20	91	12/48	
195410807	1"	25	104	12/48	
195412807	1"1/4	32	109	6/24	
195415807	1"1/2	40	127	4/16	
195420807	2"	50	135	2/8	



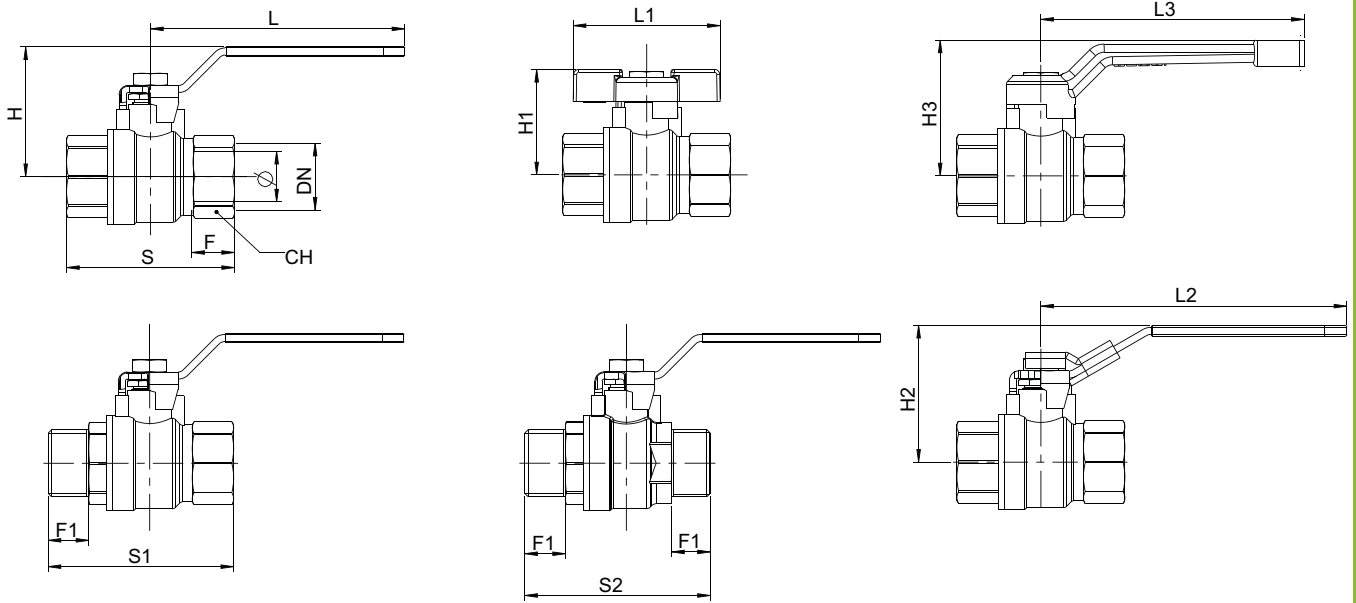

EVERLAST															
DIMENSIONI / DIMENSIONS															
DN	Ø	S	S1	S2	L	L1	L2	L3	H	H1	H2	H3	F	F1	CH
1/4"	10	42	43,5	52	80	50	95	85	40	33	43	44	9,5	10	17
3/8"	10	44	45	52	80	50	95	85	40	33	43	44	10,5	10	20
1/2"	15	50	50	58	92	50	95	85	43	37	46	47	11	10,5	25
3/4"	20	57	58	66	92	50	95	85	47	40	46	51	13	13	31
1"	25	70	70	78	115	61	120	110	59	47	64	60	15	15	38
1"1/4	32	80	81	91	115		120	110	64			64	17	17	47
1"1/2	40	90	91	102	150		150	130	75			78	18	18	54
2"	50	107	107	118	150		150	130	82			85	20	20	66
2"1/2	60	132			200				108				22		84
3"	74	151			250				117				26		96
4"	94	179			250				154				30		123

EVERLAST												
ACCESSORI / RICAMBI - ACCESSORIES / SPARE PARTS												
1/4"	700702001	700101001	700105001	700102001	703001501	703005001	703002001	750106001	125603440	125603600	109702030	
3/8"	700702001	700101001	700105001	700102001	703001501	703005001	703002001	750106001	125603440	125603600	109702030	
1/2"	700702001	700411001	700415001	700412001	703001501	703005001	703002001	750106001	125603440	125603600	109702030	
3/4"	700702001	700411001	700415001	700412001	703001501	703005001	703002001	750106001	125603440	125603600	109702030	
1"	700712001	700421001	700425001	700422001	703011501	703015001	703012001	750108001	125605440	125605600	109705030	
1"1/4	700712001	700421001	700425001	700422001				750108001	125605440	125605600	109705030	
1"1/2	700722001	700431001	700435001	700432001				750110001	125610440	125610600	109710030	
2"	700722001	700431001	700435001	700432001				750110001	125610440	125610600	109710030	
2"1/2		700441001	700445001	700442001				750116001			109720010	
3"		700441001	700445001	700442001				750116001			109720010	
4"		700151001	700155001	700152001				750118001			109725010	

IVR EVERWATER PLUS

40 bar

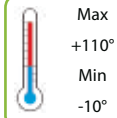

UNI EN 10226-1
(ISO 7-1 Rp)

IVR 935 PLUS

NEW



Valvola a sfera a passaggio standard - attacchi filettati F/F, con leva in alluminio nera
 Standard bore ball valve - threaded ends F/F, with black handle in aluminium
 Kugelhahn mit Standarddurchgang - IG/IG, mit schwarzem Hebelgriff aus Aluminium
 Vanne à boisseau sphérique à passage normal - fixations F/F avec poignée noire en aluminium
 Шаровой кран со стандартным проходом, соединения: резьба В/В, с черным алюминиевым рычагом

Cod./Code	DN	Ø	□/田	€
193505024	1/2"	14	15/90	
193507024	3/4"	18	20/80	
193510024	1"	23	12/48	
193512024	1"1/4	30	8/32	
193515024	1"1/2	7	4/16	
193520024	2"	47	4/16	

EAC

IVR 936 PLUS

NEW



Valvola a sfera a passaggio standard - attacchi filettati M/F, con leva in alluminio nera
 Standard bore ball valve - threaded ends M/F, with black handle in aluminium
 Kugelhahn mit Standarddurchgang - AG/IG, mit schwarzem Hebelgriff aus Aluminium
 Vanne à boisseau sphérique à passage normal - fixations M/F avec poignée noire en aluminium
 Шаровой кран со стандартным проходом, соединения: резьба Н/В, с черным алюминиевым рычагом

Cod./Code	DN	Ø	□/田	€
193605024	1/2"	14	15/90	
193607024	3/4"	18	20/80	
193610024	1"	23	12/48	
193612024	1"1/4	30	8/32	
193615024	1"1/2	7	4/16	
193620024	2"	47	4/16	

EAC

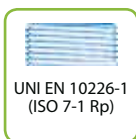
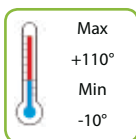
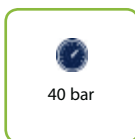

IVR EVERWATER

IVR 935



Valvola a sfera a passaggio standard - attacchi filettati F/F, con maniglia rossa
Standard bore ball valve - F/F threaded ends, with red handle
Kugelhahn mit normalem Durchgang - IG/IG, mit rotem Hebelgriff
Vanne à sphère à passage normal - fixations F/F, avec poignée rouge
Шаровой кран со стандартным проходом - соединения В/В, с красной ручкой

Cod./Code	DN	Ø	□/田	€
193505007	1/2"	14	12/72	
193507007	3/4"	18	20/80	
193510007	1"	23	12/48	
193512007	1"1/4	30	8/32	
193515007	1"1/2	7	6/24	
193520007	2"	47	4/16	

ERC

IVR 935 LB



Valvola a sfera a passaggio standard - attacchi filettati F/F, con maniglia blu
Standard bore ball valve - F/F threaded ends, with blue handle
Kugelhahn mit normalem Durchgang - IG/IG, mit blauem Hebelgriff
Vanne à sphère à passage normal - fixations F/F avec poignée bleu
Шаровой кран со стандартным проходом - соединения В/В, с голубой ручкой

Cod./Code	DN	Ø	□/田	€
193505209	1/2"	14	12/72	
193507209	3/4"	18	20/80	
193510209	1"	23	12/48	
193512209	1"1/4	30	8/32	
193515209	1"1/2	7	4/16	
193520209	2"	47	4/16	

SU RICHIESTA
ON DEMAND

ERC

NEW

IVR 935 LN



Valvola a sfera a passaggio standard - attacchi filettati F/F, con maniglia nera
Standard bore ball valve - F/F threaded ends, with black handle
Kugelhahn mit normalem Durchgang - IG/IG, mit schwarzem Hebelgriff
Vanne à sphère à passage normal - fixations F/F avec poignée noire
Шаровой кран со стандартным проходом - соединения В/В, с чёрной ручкой

Cod./Code	DN	Ø	□/田	€
193505220	1/2"	14	12/72	
193507220	3/4"	18	20/80	
193510220	1"	23	12/48	
193512220	1"1/4	30	8/32	
193515220	1"1/2	7	4/16	
193520220	2"	47	4/16	

SU RICHIESTA
ON DEMAND

ERC

NEW

IVR 935/A



Valvola a sfera a passaggio standard - attacchi filettati F/F, con farfalla rossa
Standard bore ball valve - F/F threaded ends, with red butterfly handle
Kugelhahn mit normalem Durchgang - IG/IG, mit rotem Flügelgriff
Vanne à sphère à passage normal - fixations F/F, avec papillon rouge
Шаровой кран со стандартным проходом - соединения В/В, с красной ручкой "бабочка"

EAC

Cod./Code	DN	Ø	□/田	€
193505008	1/2"	14	12/144	
193507008	3/4"	18	20/80	
193510008	1"	23	12/48	

IVR 935/A FB



Valvola a sfera a passaggio standard - attacchi filettati F/F, con farfalla blu
Standard bore ball valve - F/F threaded ends, with blue butterfly handle
Kugelhahn mit normalem Durchgang - IG/IG, mit blauem Flügelgriff
Vanne à sphère à passage normal - fixations F/F, avec papillon bleu
Шаровой кран со стандартным проходом - соединения В/В, с голубой ручкой "бабочка"



EAC



Cod./Code	DN	Ø	□/田	€
193505211	1/2"	14	12/144	
193507211	3/4"	18	20/80	
193510211	1"	23	12/48	

IVR 935/A FN



Valvola a sfera a passaggio standard - attacchi filettati F/F, con farfalla nera
Standard bore ball valve - F/F threaded ends, with black butterfly handle
Kugelhahn mit normalem Durchgang - IG/IG, mit schwarzem Flügelgriff
Vanne à sphère à passage normal - fixations F/F, avec papillon noire
Шаровой кран со стандартным проходом - соединения В/В, с чёрной ручкой "бабочка"



EAC



Cod./Code	DN	Ø	□/田	€
193505221	1/2"	14	12/144	
193507221	3/4"	18	20/80	
193510221	1"	23	12/48	

IVR 936 EVERWATER



EAC

Valvola a sfera a passaggio standard - attacchi filettati M/F, con maniglia rossa
Standard bore ball valve - M/F threaded ends, with red handle
Kugelhahn mit normalem Durchgang - AG/IG, mit rotem Hebelgriff
Vanne à sphère à passage normal - fixations M/F, avec poignée rouge
Шаровой кран со стандартным проходом - соединения Н/В, с красной ручкой

Cod./Code	DN	Ø	□/田	€
193605007	1/2"	14	12/72	
193607007	3/4"	18	20/80	
193610007	1"	23	12/48	
193612007	1"1/4	30	6/24	
193615007	1"1/2	37	4/16	
193620007	2"	47	4/16	

IVR 936 LB



EAC

SU RICHIESTA
ON DEMAND

Valvola a sfera a passaggio standard - attacchi filettati M/F, con maniglia blu
Standard bore ball valve - M/F threaded ends, with blue handle
Kugelhahn mit normalem Durchgang - AG/IG, mit blauem Hebelgriff
Vanne à sphère à passage normal - fixations M/F avec poignée bleu
Шаровой кран со стандартным проходом - соединения Н/В, с голубой ручкой

Cod./Code	DN	Ø	□/田	€
193605209	1/2"	14	12/72	
193607209	3/4"	18	20/80	
193610209	1"	23	12/48	
193612209	1"1/4	30	6/24	
193615209	1"1/2	37	4/16	
193620209	2"	47	4/16	



IVR 936 LN



EAC

SU RICHIESTA
ON DEMAND

Valvola a sfera a passaggio standard - attacchi filettati M/F, con maniglia nera
Standard bore ball valve - M/F threaded ends, with black handle
Kugelhahn mit normalem Durchgang - AG/IG, mit schwarzem Hebelgriff
Vanne à sphère à passage normal - fixations M/F avec poignée noire
Шаровой кран со стандартным проходом - соединения Н/В, с чёрной ручкой

Cod./Code	DN	Ø	□/田	€
193605220	1/2"	14	20/120	
193607220	3/4"	18	20/80	
193610220	1"	23	12/48	
193612220	1"1/4	30	8/32	
193615220	1"1/2	37	6/24	
193620220	2"	47	4/16	



IVR 936/A



Valvola a sfera a passaggio standard - attacchi filettati M/F, con farfalla rossa
 Standard bore ball valve - M/F threaded ends, with red butterfly handle
 Kugelhahn mit normalem Durchgang - AG/IG, mit rotem Flügelgriff
 Vanne à sphère à passage normal - fixations M/F, avec papillon rouge
 Шаровой кран со стандартным проходом - соединения Н/В, с красной ручкой "бабочка"



Cod./Code	DN	Ø	□/田	€
193605008	1/2"	14	12/72	
193607008	3/4"	18	20/80	
193610008	1"	23	12/48	

IVR 936/A FB



Valvola a sfera a passaggio standard - attacchi filettati M/F, con farfalla blu
 Standard bore ball valve - M/F threaded ends, with blue butterfly handle
 Kugelhahn mit normalem Durchgang - AG/IG, mit blauem Flügelgriff
 Vanne à sphère à passage normal - fixations M/F, avec papillon bleu
 Шаровой кран со стандартным проходом - соединения Н/В, с голубой ручкой "бабочка"



Cod./Code	DN	Ø	□/田	€
193605211	1/2"	14	12/72	
193607211	3/4"	18	20/80	
193610211	1"	23	12/48	

IVR 936/A FN



Valvola a sfera a passaggio standard - attacchi filettati M/F, con farfalla nera
 Standard bore ball valve - M/F threaded ends, with black butterfly handle
 Kugelhahn mit normalem Durchgang - AG/IG, mit schwarzem Flügelgriff
 Vanne à sphère à passage normal - fixations M/F, avec papillon noire
 Шаровой кран со стандартным проходом - соединения Н/В, с чёрной ручкой "бабочка"



Cod./Code	DN	Ø	□/田	€
193605221	1/2"	14	12/72	
193607221	3/4"	18	20/80	
193610221	1"	23	12/48	

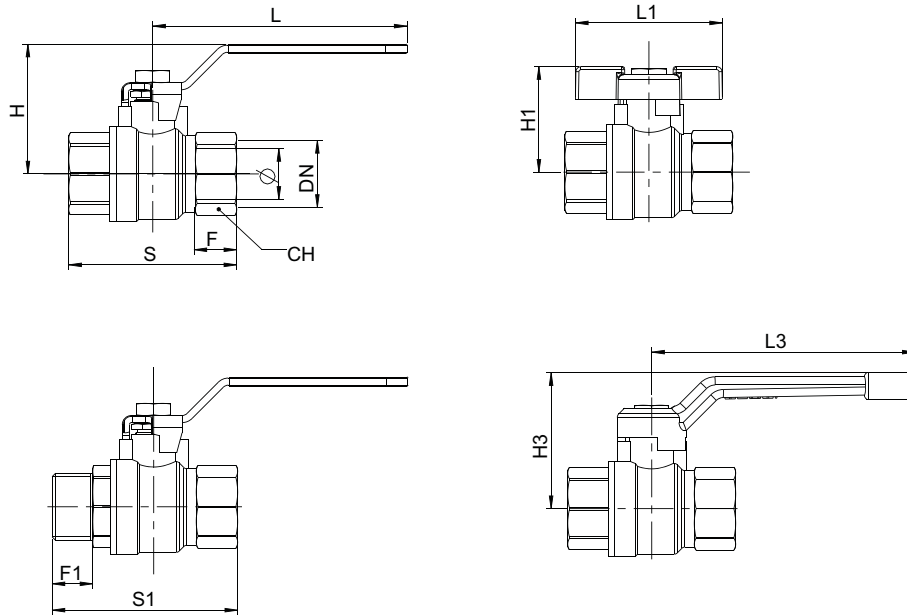

EVERWATER

DIMENSIONI / DIMENSIONS

DN	Ø	S	S1	S2	L	L1	L2	L3	H	H1	H2	H3	F	F1	CH
1/2"	14	55	63,5		92	50		85	42,5	36		47	15	15	25
3/4"	18	61,5	69		92	50		85	45	39		49	16	16	31
1"	23	73	81,5		115	61		85	60	45		58	18	18	38
1"1/4	29	85,5	94,5		115			85	64			62	20,5	20,5	47
1"1/2	37	97	106		150			110	74,5			77	20,5	20,5	54
2"	47	117	129		150			110	81,5			84	25,5	25	66



EVERWATER

ACCESSORI / RICAMBI - ACCESSORIES / SPARE PARTS

1/2"	700702001	700411001	700415001	700412001	703001501	703005001	703002001	750106001	125603440	125603600	109702030
3/4"	700702001	700411001	700415001	700412001	703001501	703005001	703002001	750106001	125603440	125603600	109702030
1"	700712001	700421001	700425001	700422001	703011501	703015001	703012001	750108001	125605440	125605600	109705030
1"1/4	700712001	700421001	700425001	700422001				750108001	125605440	125605600	109705030
1"1/2	700722001	700431001	700435001	700432001				750110001	125610440	125610600	109710030
2"	700722001	700431001	700435001	700432001				750110001	125610440	125610600	109710030

IVR EVERMID



40 bar



Max
+150°
Min
-10°



UNI ISO 228-1

IVR 918



Valvola a sfera a passaggio standard - attacchi F/F, con maniglia rossa
Standard bore ball valve - threaded ends F/F, with red handle
Kugelhahn mit Standarddurchgang - IG/IG, mit rotem Hebelgriff
Vanne à boisseau sphérique à passage normal - fixations F/F, avec poignée rouge
Шаровой кран со стандартным проходом - соединения В/В, с красной ручкой

Cod./Code	DN	Ø	□/田	€
191805007	1/2"	14	20/120	
191807007	3/4"	18	20/80	
191810007	1"	23	12/48	
191812007	1"1/4	30	8/32	
191815007	1"1/2	37	6/24	
191820007	2"	47	4/16	
191825007	2"1/2	50	12	
191830007	3"	61	6	
191840007	4"	74	6	



IVR 918 LB



Valvola a sfera a passaggio standard - attacchi F/F, con maniglia blu
Standard bore ball valve - threaded ends F/F, with blue handle
Kugelhahn mit Standarddurchgang - IG/IG, mit blauem Hebelgriff
Vanne à boisseau sphérique à passage normal - fixations F/F, avec poignée bleu
Шаровой кран со стандартным проходом - соединения В/В, с голубой ручкой

Cod./Code	DN	Ø	□/田	€
191805209	1/2"	14	20/120	
191807209	3/4"	18	20/80	
191810209	1"	23	12/48	
191812209	1"1/4	30	8/32	
191815209	1"1/2	37	6/24	
191820209	2"	47	4/16	
191825209	2"1/2	50	12	
191830209	3"	61	6	
191840209	4"	74	6	



IVR 918 LN



Valvola a sfera a passaggio standard - attacchi F/F, con maniglia nera
Standard bore ball valve - threaded ends F/F, with black handle
Kugelhahn mit Standarddurchgang - IG/IG, mit schwarzem Hebelgriff
Vanne à boisseau sphérique à passage normal - fixations F/F avec poignée noire
Шаровой кран со стандартным проходом - соединения В/В, с чёрной ручкой

Cod./Code	DN	Ø	□/田	€
191805219	1/2"	14	20/120	
191807219	3/4"	18	20/80	
191810219	1"	23	12/48	
191812219	1"1/4	30	8/32	
191815219	1"1/2	37	6/24	
191820219	2"	47	4/16	
191825219	2"1/2	50	12	
191830219	3"	61	6	
191840219	4"	74	6	



IVR 918/A



Valvola a sfera a passaggio standard - attacchi F/F, con farfalla rossa
Standard bore ball valve - threaded ends F/F, with red butterfly handle
Kugelhahn mit Standarddurchgang - IG/IG, mit rotem Flügelgriff
Vanne à boisseau sphérique à passage normal - fixations F/F, avec papillon rouge
Шаровой кран со стандартным проходом - соединения В/В, с красной ручкой "бабочка"



Cod./Code	DN	Ø	□/田	€
191805008	1/2"	14	20/120	
191807008	3/4"	18	20/80	
191810008	1"	23	12/48	

IVR 918/A FB



Valvola a sfera a passaggio standard - attacchi F/F, con farfalla blu
Standard bore ball valve - threaded ends F/F, with blue butterfly handle
Kugelhahn mit Standarddurchgang - IG/IG, mit blauem Flügelgriff
Vanne à boisseau sphérique à passage normal - fixations F/F, avec papillon bleu
Шаровой кран со стандартным проходом - соединения В/В, с голубой ручкой "бабочка"



Cod./Code	DN	Ø	□/田	€
191805211	1/2"	14	20/120	
191807211	3/4"	18	20/80	
191810211	1"	23	12/48	



IVR 918/A FN



Valvola a sfera a passaggio standard - attacchi F/F, con farfalla nera
Standard bore ball valve - threaded ends F/F, with black butterfly handle
Kugelhahn mit Standarddurchgang - IG/IG, mit schwarzem Flügelgriff
Vanne à boisseau sphérique à passage normal - fixations F/F, avec papillon noire
Шаровой кран со стандартным проходом - соединения В/В, с чёрной ручкой "бабочка"



Cod./Code	DN	Ø	□/田	€
191805335	1/2"	14	20/120	
191807335	3/4"	18	20/80	
191810335	1"	23	12/48	

IVR 919



Valvola a sfera a passaggio standard - attacchi M/F, con maniglia rossa
 Standard bore ball valve - threaded ends M/F, with red handle
 Kugelhahn mit Standarddurchgang - AG/IG, mit rotem Hebelgriff
 Vanne à boisseau sphérique à passage normal - fixations M/F, avec poignée rouge
 Шаровой кран со стандартным проходом - соединения Н/В, с красной ручкой



Cod./Code	DN	Ø	□/田	€
191905007	1/2"	14	20/120	
191907007	3/4"	18	20/80	
191910007	1"	23	12/48	
191912007	1"1/4	30	8/32	
191915007	1"1/2	37	6/24	
191920007	2"	47	4/16	

IVR 919 LB



Valvola a sfera a passaggio standard - attacchi M/F, con maniglia blu
 Standard bore ball valve - threaded ends M/F, with blue handle
 Kugelhahn mit Standarddurchgang - AG/IG, mit blauem Hebelgriff
 Vanne à boisseau sphérique à passage normal - fixations M/F, avec poignée bleu
 Шаровой кран со стандартным проходом - соединения Н/В, с голубой ручкой



Cod./Code	DN	Ø	□/田	€
191905209	1/2"	14	20/120	
191907209	3/4"	18	20/80	
191910209	1"	23	12/48	
191912209	1"1/4	30	8/32	
191915209	1"1/2	37	6/24	
191920209	2"	47	4/16	



IVR 919 LN



Valvola a sfera a passaggio standard - attacchi M/F con maniglia nera
 Standard bore ball valve - threaded ends M/F, with black handle
 Kugelhahn mit Standarddurchgang - AG/IG, mit schwarzem Hebelgriff
 Vanne à boisseau sphérique à passage normal - fixations M/F avec poignée noire
 Шаровой кран со стандартным проходом, соединения Н/В, с черной ручкой



Cod./Code	DN	Ø	□/田	€
191905219	1/2"	14	20/120	
191907219	3/4"	18	20/80	
191910219	1"	23	12/48	
191912219	1"1/4	30	8/32	
191915219	1"1/2	37	6/24	
191920219	2"	47	4/16	



IVR 919/A



Valvola a sfera a passaggio standard - attacchi M/F, con farfalla rossa
Standard bore ball valve - threaded ends M/F, with red butterfly handle
Kugelhahn mit Standarddurchgang - AG/IG, mit rotem Flügelgriff
Vanne à boisseau sphérique à passage normal - fixations M/F, avec papillon rouge
Шаровой кран со стандартным проходом - соединения Н/В, с красной ручкой "бабочка"



Cod./Code	DN	Ø	□/田	€
191905008	1/2"	14	20/120	
191907008	3/4"	18	20/80	
191910008	1"	23	12/48	

IVR 919/A FB



Valvola a sfera a passaggio standard - attacchi M/F, con farfalla blu
Standard bore ball valve - threaded ends M/F, with blue butterfly handle
Kugelhahn mit Standarddurchgang - AG/IG, mit blauem Flügelgriff
Vanne à boisseau sphérique à passage normal - fixations M/F, avec papillon bleu
Шаровой кран со стандартным проходом - соединения Н/В, с голубой ручкой "бабочка"



Cod./Code	DN	Ø	□/田	€
191905211	1/2"	14	20/120	
191907211	3/4"	18	20/80	
191910211	1"	23	12/48	



IVR 919/A FN



Valvola a sfera a passaggio standard - attacchi M/F, con farfalla nera
Standard bore ball valve - threaded ends M/F, with black butterfly handle
Kugelhahn mit Standarddurchgang - AG/IG, mit schwarzem Flügelgriff
Vanne à boisseau sphérique à passage normal - fixations M/F, avec papillon noire
Шаровой кран со стандартным проходом - соединения Н/В, с чёрной ручкой "бабочка"



Cod./Code	DN	Ø	□/田	€
191905335	1/2"	14	20/120	
191907335	3/4"	18	20/80	
191910335	1"	23	12/48	

IVR 920



Valvola a sfera a passaggio standard - attacchi M/M con maniglia rossa
Standard bore ball valve - threaded ends M/M with red handle
Kugelhahn mit Standarddurchgang - AG/AG, mit rotem Hebelgriff
Vanne à boisseau sphérique à passage normal - fixations M/M avec poignée rouge
Шаровой кран со стандартным проходом, соединения Н/Н, с красной ручкой



Cod./Code	DN	Ø	□/田	€
192005007	1/2"	14	20/120	
192007007	3/4"	18	20/80	

IVR 920 LB



Valvola a sfera a passaggio standard - attacchi M/M con maniglia blu
Standard bore ball valve - threaded ends M/M with blue handle
Kugelhahn mit Standarddurchgang - AG/AG, mit blauem Hebelgriff
Vanne à boisseau sphérique à passage normal - fixations M/M avec poignée bleue
Шаровой кран со стандартным проходом, соединения Н/Н, с голубой ручкой



Cod./Code	DN	Ø	□/田	€
192005209	1/2"	14	20/120	
192007209	3/4"	18	20/80	

IVR 920 LN



Valvola a sfera a passaggio standard - attacchi M/M con maniglia nera
Standard bore ball valve - threaded ends M/M with black handle
Kugelhahn mit Standarddurchgang - AG/AG, mit schwarzem Hebelgriff
Vanne à boisseau sphérique à passage normal - fixations M/M avec poignée noire
Шаровой кран со стандартным проходом, соединения Н/Н, с черной ручкой



Cod./Code	DN	Ø	□/田	€
192005219	1/2"	14	20/120	
192007219	3/4"	18	20/80	

IVR 920/A



Valvola a sfera a passaggio standard - attacchi M/M con farfalla rossa
Standard bore ball valve - threaded ends M/M with red butterfly handle
Kugelhahn mit Standarddurchgang - AG/AG, mit rotem Flügelgriff
Vanne à boisseau sphérique à passage normal - fixations M/M avec poignée papillon rouge
Шаровой кран со стандартным проходом, соединения Н/Н, с красной ручкой "бабочка"



Cod./Code	DN	Ø	□/田	€
192005008	1/2"	14	20/120	
192007008	3/4"	18	20/80	

IVR 920/A FB



Valvola a sfera a passaggio standard - attacchi M/M con farfalla blu
Standard bore ball valve - threaded ends M/M with blue butterfly handle
Kugelhahn mit Standarddurchgang - AG/AG, mit blauem Flügelgriff
Vanne à boisseau sphérique à passage normal - fixations M/M avec poignée papillon bleue
Шаровой кран со стандартным проходом, соединения Н/Н, с голубой ручкой "бабочка"



Cod./Code	DN	Ø	□/田	€
192005211	1/2"	14	20/120	
192007211	3/4"	18	20/80	

IVR 920/A FN



Valvola a sfera a passaggio standard - attacchi M/M con farfalla nera
Standard bore ball valve - threaded ends M/M with black butterfly handle
Kugelhahn mit Standarddurchgang - AG/AG, mit schwarzem Flügelgriff
Vanne à boisseau sphérique à passage normal - fixations M/M avec poignée papillon noire
Шаровой кран со стандартным проходом, соединения Н/Н, с черной ручкой "бабочка"



Cod./Code	DN	Ø	□/田	€
192005335	1/2"	14	20/120	
192007335	3/4"	18	20/80	



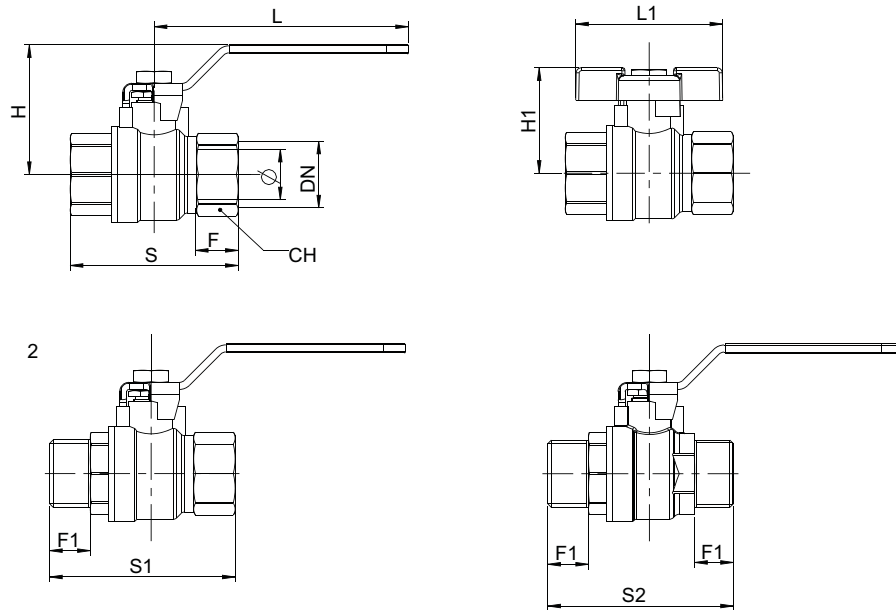

EVERMID															
DIMENSIONI / DIMENSIONS															
DN	Ø	S	S1	S2	L	L1	L2	L3	H	H1	H2	H3	F	F1	CH
1/2"	14	46	53	53	80	50			43	36			11	10	24
3/4"	18	52	58	58	80	50			45	39			11,5	11	30
1"	23	62	68		115	61			58	45			13,5	13	36
1 1/4"	29	74	82		115				62				16	15	46
1 1/2"	37	87	96		150				74				16,5	16	52
2"	47	98	107		150				81				17	17	65
2 1/2"	50	109			140				85				20		83
3"	61	148			220				116				24		96
4"	74	XXX			220				116				27		121

EVERMID										
ACCESSORI / RICAMBI - ACCESSORIES / SPARE PARTS										
1/2"	700101001	700105001	700102001	703001501	703005001	703002001	750106001	125603440	125603600	109702030
3/4"	700101001	700105001	700102001	703001501	703005001	703002001	750106001	125603440	125603600	109702030
1"	700421001	700425001	700422001	703011501	703015001	703012001	750108001	125605440	125605600	109705030
1 1/4"	700421001	700425001	700422001				750108001	125605440	125605600	109705030
1 1/2"	700431001	700435001	700432001				750110001	125610440	125610600	109710030
2"	700431001	700435001	700432001				750110001	125610440	125610600	109710030
2 1/2"	700131001	700135001	700132001				750114001			109715030
3"	700441001	700445001	700442001				750116001			109720010
4"	700441001	700445001	700442001				750116001			109720010

IVR 58 TUBO RAME



Valvola a sfera a passaggio totale - attacchi tubo rame a compressione
Full bore ball valve with compression ends for copper pipe
Kugelhahn mit vollem Durchgang - mit Kompression-Anschlüssen für Kupferrohr
Vanne à boisseau sphérique à passage intégral avec fixation tube en cuivre à compression
Полнопроходной шаровой кран - компрессионные соединения для медной трубы



Cod./Code	DN	Ø	□/田	€
105815007	15	15	20/80	
105822007	22	20	20/80	
105828007	28	25	10/40	

IVR 58/A TUBO RAME



Valvola a sfera a passaggio totale - attacchi tubo rame a compressione
Full bore ball valve with compression ends for copper pipe
Kugelhahn mit vollem Durchgang - mit Kompression-Anschlüssen für Kupferrohr
Vanne à boisseau sphérique à passage intégral avec fixation tube en cuivre à compression
Полнопроходной шаровой кран - компрессионные соединения для медной трубы



Cod./Code	DN	Ø	□/田	€
105815002	15	15	20/80	
105822002	22	20	20/80	
105828002	28	25	10/40	



IVR ELITE GW 4MS

50 bar

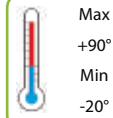

IVR 100 GW 4MS



Valvola a sfera a passaggio totale per acqua potabile - Antilegionella, antigelo - attacchi F/F

Full bore ball valve for drinking water - anti-legionella and anti-freeze - threaded ends F/F

Kugelhahn mit vollem Durchgang - Antilegionellenfunktion - für Trinkwasser - IG/IG

Vanne à boisseau sphérique à passage intégral pour eau potable - anti-légionelle, antigel - fixations F/F

Полнопроходной шаровой кран для питьевой воды - конструкция «антилегионелла», с защитой от замерзания, соединения В/В

Cod./Code	DN	Ø	□/⊞	€
110003200	3/8"	10	10/120	
110005200	1/2"	15	12/72	
110007200	3/4"	20	20/80	
110010200	1"	25	12/48	
110012200	1"1/4	32	6/24	
110015200	1"1/2	40	4/16	
110020200	2"	50	2/8	



IVR 100/A GW 4MS



Valvola a sfera a passaggio totale per acqua potabile - Antilegionella, antigelo - attacchi F/F

Full bore ball valve for drinking water - anti-legionella and anti-freeze - threaded ends F/F

Kugelhahn mit vollem Durchgang - Antilegionellenfunktion - für Trinkwasser - IG/IG

Vanne à boisseau sphérique à passage intégral pour eau potable - anti-légionelle, antigel - fixations F/F

Полнопроходной шаровой кран для питьевой воды - конструкция «антилегионелла», с защитой от замерзания, соединения В/В

Cod./Code	DN	Ø	□/⊞	€
110003201	3/8"	10	10/120	
110005201	1/2"	15	12/72	
110007201	3/4"	20	20/80	
110010201	1"	25	12/48	



IVR 101 GW 4MS



Valvola a sfera a passaggio totale per acqua potabile - Antilegionella, antigelo - attacchi M/F

Full bore ball valve for drinking water - anti-legionella and anti-freeze - threaded ends M/F

Kugelhahn mit vollem Durchgang - Antilegionellenfunktion - für Trinkwasser - AG/IG

Vanne à boisseau sphérique à passage intégral pour eau potable - anti-légionelle, antigel - fixations M/F

Полнопроходной шаровой кран для питьевой воды - конструкция «антилегионелла», с защитой от замерзания, соединения Н/В

Cod./Code	DN	Ø	□/⊞	€
110103200	3/8"	10	10/120	
110105200	1/2"	15	12/72	
110107200	3/4"	20	15/60	
110110200	1"	25	12/48	
110112200	1"1/4	32	6/24	
110115200	1"1/2	40	4/16	
110120200	2"	50	2/8	



IVR 101/A GW 4MS



Valvola a sfera a passaggio totale per acqua potabile - Antilegionella, antigelo - attacchi M/F
Full bore ball valve for drinking water - anti-legionella and anti-freeze - threaded ends M/F
Kugelhahn mit vollem Durchgang-Antilegionellenfunktion - für Trinkwasser - AG/IG
Vanne à boisseau sphérique à passage intégral pour eau potable - anti-légionelle, antigel - fixations M/F
Полнопроходной шаровой кран для питьевой воды - конструкция «антилегионелла», с защитой от замерзания, соединения Н/В



Cod./Code	DN	Ø	□/田	€
110103201	3/8"	10	10/120	
110105201	1/2"	15	12/72	
110107201	3/4"	20	15/60	
110110201	1"	25	10/40	

IVR 208 GW 4MS SPURGO



Valvola a sfera a passaggio totale per acqua potabile - antilegionella, antigelo - con rubinetto di scarico - attacchi F/F
Full bore ball valve for drinking water - anti-legionella and anti-freeze - with drain valve threaded ends F/F
Kugelhahn mit vollem Durchgang und Ablasshahn - Antilegionellenfunktion - Für Trinkwasser - IG/IG
Vanne à boisseau sphérique à passage intégral pour eau potable - anti-légionelle, antigel - avec robinet de vidange - fixations F/F
Полнопроходной шаровой кран для питьевой воды - конструкция «антилегионелла» с защитой от замерзания - со спускным краном - соединения В/В



Cod./Code	DN	Ø	□/田	€
120805215	1/2"	15	12/72	
120807215	3/4"	20	20/80	
120810215	1"	25	12/48	
120812215	1"1/4	32	6/24	
120815215	1"1/2	40	4/16	
120820215	2"	50	2/8	

IVR 208/A GW 4MS SPURGO



Valvola a sfera a passaggio totale per acqua potabile - antilegionella, antigelo - con rubinetto di scarico - attacchi F/F
Full bore ball valve for drinking water - anti-legionella and anti-freeze - with drain valve threaded ends F/F
Kugelhahn mit vollem Durchgang und Ablasshahn - Antilegionellenfunktion - Für Trinkwasser - IG/IG
Vanne à boisseau sphérique à passage intégral pour eau potable - anti-légionelle, antigel - avec robinet de vidange - fixations F/F
Полнопроходной шаровой кран для питьевой воды - конструкция «антилегионелла» с защитой от замерзания - со спускным краном - соединения В/В



Cod./Code	DN	Ø	□/田	€
120805216	1/2"	15	12/72	
120807216	3/4"	20	20/80	
120810216	1"	25	12/48	
120812216	1"1/4	32	6/24	



VALVOLE ACQUA
 WATER VALVES
 KUGELHÄHNE FÜR WASSER
 VANNES EAU
 ЗАПОРНАЯ АРМАТУРА ДЛЯ ВОДЫ

IVR 137 GW 4MS RIDUTTORE



Valvola a sfera a passaggio totale per acqua potabile - antilegionella, antigelo - con riduttore di manovra - attacchi F/F

Full bore ball valve for drinking water - anti-legionella and anti-freeze - with gauge handle threaded ends F/F

Kugelhahn mit vollem Durchgang und Getriebe - Antilegionellenfunktion - für Trinkwasser - IG/IG

Vanne à boisseau sphérique à passage intégral pour eau potable - anti-légionelle, antigel - avec réducteur de manoeuvre - fixations F/F

Полнопроходной шаровой кран для питьевой воды - конструкция «антилегионелла» с защитой от замерзания - с редуктором управления - соединения В/В

Cod./Code	DN	Ø	□/田	€
113703200	3/8"	10	15/60	
113705200	1/2"	15	9/36	
113707200	3/4"	20	8/32	
113710200	1"	25	8/32	
113712200	1"1/4	32	6/24	
113715200	1"1/2	40	2/8	
113720200	2"	50	2/8	



IVR 157 GW 4MS RIDUTTORE



Valvola a sfera a passaggio totale per acqua potabile - antilegionella, antigelo - con riduttore di manovra - attacchi M/F

Full bore ball valve for drinking water - anti-legionella and anti-freeze - with gauge handle threaded ends M/F

Kugelhahn mit vollem Durchgang und Getriebe - Antilegionellenfunktion - für Trinkwasser - AG/IG

Vanne à boisseau sphérique à passage intégral pour eau potable - anti-légionelle, antigel - avec réducteur de manoeuvre - fixations M/F

Полнопроходной шаровой кран для питьевой воды - конструкция «антилегионелла» с защитой от замерзания - с редуктором управления - соединения Н/В

Cod./Code	DN	Ø	□/田	€
115703200	3/8"	10	15/60	
115705200	1/2"	15	9/36	
115707200	3/4"	20	8/32	
115710200	1"	25	8/32	
115712200	1"1/4	32	6/24	
115715200	1"1/2	40	2/8	
115720200	2"	50	2/8	



IVR 120 GW 4MS CAPPUCCIO SIGILLABILE



Valvola a sfera a passaggio totale per acqua potabile - Antilegionella, antigelo con cappuccio sigillabile - attacchi F/F

Full bore ball valve for drinking water - anti-legionella and anti-freeze - with sealing cap ends F/F

Kugelhahn mit vollem Durchgang - Antilegionellenfunktion - für Trinkwasser mit abdichtbarer Kappe - IG/IG

Vanne à boisseau sphérique à passage intégral pour eau potable - anti-légionelle, antigel - avec capuchon scellable - fixations F/F

Полнопроходной шаровой кран для питьевой воды - конструкция «антилегионелла» с защитой от замерзания - с колпачком под пломбировку - соединения В/В

Cod./Code	DN	Ø	□/田	€
112005200	1/2"	15	12/72	
112007200	3/4"	20	20/80	
112010200	1"	25	12/48	
112012200	1"1/4	32	6/24	
112015200	1"1/2	40	4/16	
112020200	2"	50	2/8	



IVR 121 GW 4MS CAPPUCCIO SIGILLABILE



Valvola a sfera a passaggio totale per acqua potabile - Antilegionella, antigelo con cappuccio sigillabile - attacchi M/F

Full bore ball valve for drinking water - anti-legionella and anti-freeze - with sealing cap ends M/F

Kugelhahn mit vollem Durchgang - Antilegionellenfunktion-für Trinkwasser mit abdichtbarer Kappe - AG/IG

Vanne à boisseau sphérique à passage intégral pour eau potable - anti-légionelle, antigel - avec capouchon scellable - fixations M/F

Полнопроходной шаровой кран для питьевой воды - конструкция «антилегионелла» с защитой от замерзания - с колпачком под пломбировку - соединения H/B

Cod./Code	DN	Ø	□/田	€
112105200	1/2"	15	12/72	
112107200	3/4"	20	15/60	
112110200	1"	25	12/48	
112112200	1"1/4	32	6/24	
112115200	1"1/2	40	4/16	
112120200	2"	50	2/8	

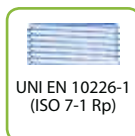
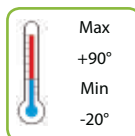
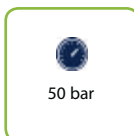

IVR ELITE GW 4MS KIWA

IVR 100 GW 4MS KIWA



Valvola a sfera a passaggio totale per acqua potabile - omologata KIWA - attacchi F/F

Full bore ball valve for drinking water - KIWA certified - F/F

Kugelhahn mit vollem Durchgang für Trinkwasser - Zulassung KIWA - IG/IG

Vanne à boisseau sphérique à passage intégral - certification KIWA - F/F

Полнопроходной шаровой кран для питьевой воды - сертификат KIWA - соединения B/B

Cod./Code	DN	Ø	□/田	€
110003224	3/8"	10	10/120	
110005224	1/2"	15	12/72	
110007224	3/4"	20	20/80	
110010224	1"	25	10/40	



Cod./Code	DN	Ø	□/田	€
113712200	1" 1/4	32	6/24	
113715200	1" 1/2	40	4/16	
113720200	2"	50	2/8	



IVR 101 GW 4MS KIWA



Valvola a sfera a passaggio totale per acqua potabile - omologata KIWA - attacchi M/F
 Full bore ball valve for drinking water - KIWA certified - M/F
 Kugelhahn mit vollem Durchgang für Trinkwasser - Zulassung KIWA - AG/IG
 Vanne à boisseau sphérique à passage intégral - certification KIWA - M/F
 Полнопроходной шаровой кран для питьевой воды - сертификат KIWA - соединения Н/В

Cod./Code	DN	Ø	□/田	€
110103224	3/8"	10	10/120	
110105224	1/2"	15	12/72	
110107224	3/4"	20	15/60	
110110224	1"	25	10/40	

Cod./Code	DN	Ø	□/田	€
115712200	1" 1/4	32	6/24	
115715200	1" 1/2	40	4/16	
115720200	2"	50	2/8	



IVR 208 GW 4MS KIWA



Valvola a sfera a passaggio totale per acqua potabile con spurgo - omologata KIWA - attacchi F/F
 Full bore ball valve for drinking water with drain - KIWA certified - F/F
 Kugelhahn mit vollem Durchgang für Trinkwasser mit Ablasshahn - Zulassung KIWA - IG/IG
 Vanne à boisseau sphérique à passage intégral pour eau potable avec robinet d'évacuation- certification KIWA - F/F
 Полнопроходной шаровой кран для питьевой воды со спускным краном - сертификат KIWA - соединения В/В





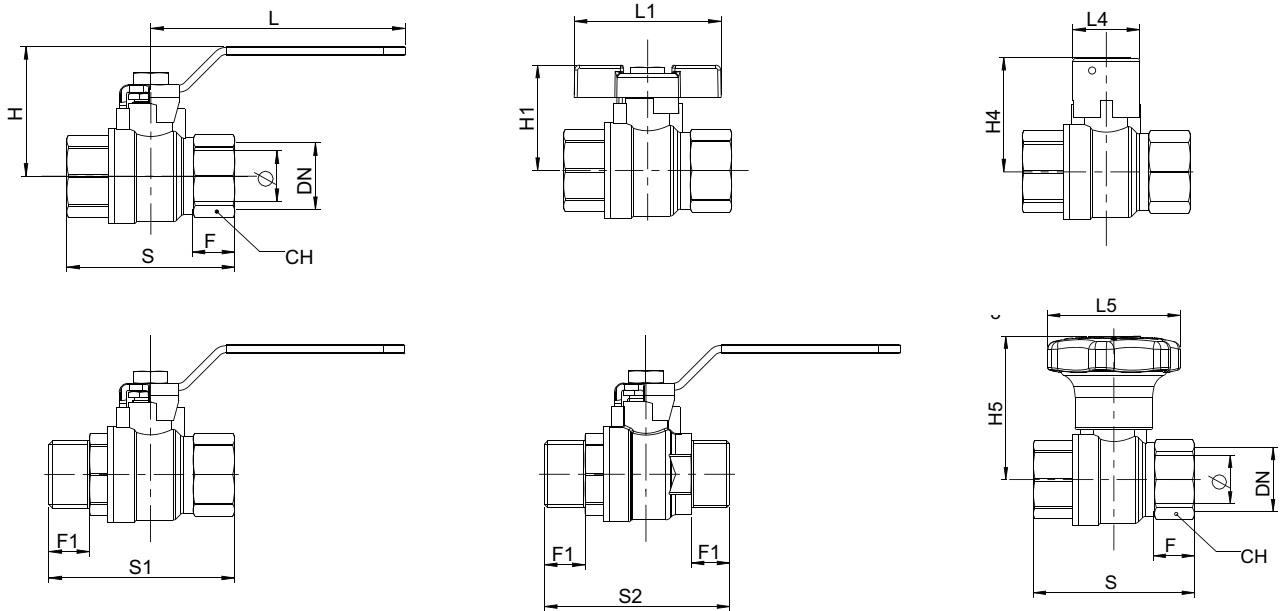

Cod./Code	DN	Ø	□/田	€
120805224	1/2"	15	10/60	
120807224	3/4"	20	20/80	
120810224	1"	25	12/48	

Cod./Code	DN	Ø	□/田	€
120812227	1" 1/4	32	8/32	
120815227	1" 1/2	40	4/16	
120820227	2"	50	2/8	





ELITE GW		DIMENSIONI / DIMENSIONS													
DN	Ø	S	S1	S2	L	L1	L4	L5	H	H1	H4	H5	F	F1	CH
3/8"	10	45	54	54	80	50		70	41	33		59	12	12	21
1/2"	15	63	70	68	90	61	29	70	52	39	45	65	17	15	26
3/4"	20	71	80	77	90	61	29	70	55	43	49	68	19,5	15,6	31
1"	25	83	92	92	125	72	33	70	65		56	76	21	19	38
1 1/4"	32	92	102		125		33	70	69		61	81	22	20,5	48
1 1/2"	40	104	117		140		44	112	78		75	105	23,5	21,5	55
2"	50	124	137		140		44	112	85		82	112	28	24,5	68

ELITE GW		ACCESSORI / RICAMBI - ACCESSORIES / SPARE PARTS				
						
3/8"	700107001	703007001	750106001	707007001		109702030
1/2"	700117001	703017001	750108001	707017001	706017000	109705030
3/4"	700117001	703017001	750108001	707017001	706017000	109705030
1"	700127001	703027001	750110001	707027001	706027000	109710030
1 1/4"	700127001	703027001	750110001	707027001	706027000	109710030
1 1/2"	700137001		750114001	707037001	706037000	109715030
2"	700137001		750114001	707037001	706037000	109715030

IVR SOLAR LINE



50 bar

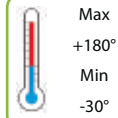

Max
+180°
Min
-30°



UNI ISO 228-1

IVR 440



Valvola a sfera a passaggio totale - SOLAR LINE - attacchi F/F
 Full bore ball valve SOLAR LINE - threaded ends F/F
 Kugelhahn mit vollem Durchgang - SOLAR LINE - IG/IG
 Vanne à boisseau sphérique à passage intégral SOLAR LINE - fixations F/F
 Полнопроходной шаровой кран - SOLAR LINE - соединения В/В

Cod./Code	DN	Ø	□/田	€
144003007	3/8"	10	10/60	
144005007	1/2"	15	12/48	
144007007	3/4"	20	12/48	
144010007	1"	25	8/32	
144012007	1"1/4	32	6/24	
144015007	1"1/2	40	4/16	
144020007	2"	50	2/8	



IVR 440/A



Valvola a sfera a passaggio totale - SOLAR LINE - attacchi F/F
 Full bore ball valve SOLAR LINE - threaded ends F/F
 Kugelhahn mit vollem Durchgang - SOLAR LINE - IG/IG
 Vanne à boisseau sphérique à passage intégral SOLAR LINE - fixations F/F
 Полнопроходной шаровой кран - SOLAR LINE - соединения В/В

Cod./Code	DN	Ø	□/田	€
144003008	3/8"	10	10/60	
144005008	1/2"	15	12/48	
144007008	3/4"	20	12/48	
144010008	1"	25	8/32	



IVR 441



Valvola a sfera a passaggio totale - SOLAR LINE - attacchi M/F
 Full bore ball valve SOLAR LINE - threaded ends M/F
 Kugelhahn mit vollem Durchgang - SOLAR LINE - AG/IG
 Vanne à boisseau sphérique à passage intégral SOLAR LINE - fixations M/F
 Полнопроходной шаровой кран - SOLAR LINE - соединения Н/В

Cod./Code	DN	Ø	□/田	€
144103007	3/8"	10	10/60	
144105007	1/2"	15	12/48	
144107007	3/4"	20	12/48	
144110007	1"	25	8/32	
144112007	1"1/4	32	6/24	
144115007	1"1/2	40	4/16	
144120007	2"	50	2/8	



IVR 441/A



EAC

Valvola a sfera a passaggio totale - SOLAR LINE - attacchi M/F
Full bore ball valve SOLAR LINE - threaded ends M/F
Kugelhahn mit vollem Durchgang - SOLAR LINE - AG/IG
Vanne à boisseau sphérique à passage intégral SOLAR LINE - fixations M/F
Полнопроходной шаровой кран - SOLAR LINE - соединения H/B

Cod./Code	DN	Ø	□/田	€
144103008	3/8"	10	10/60	
144105008	1/2"	15	12/48	
144107008	3/4"	20	12/48	
144110008	1"	25	8/32	

IVR 442



EAC

Valvola automatica sfiato aria
Automatic air-vent valve
Automatisches Entlüftungsventil
Vanne automatique de purge d'air
Автоматический воздухоотводчик

Cod./Code	DN	Ø	□/田	€
144203001	3/8"	10	8/48	
144205001	1/2"	15	8/48	

IVR 443



EAC

Valvola sicurezza F/F
Safety valve F/F
Sicherheitsventil, IG/IG
Groupe de sécurité F/F
Предохранительный клапан В/В

Cod./Code	DN	Ø	□/田	€
144305301	1/2"x3/4" - 3 bar	10	10/60	
144305401	1/2"x3/4" - 4 bar	15	10/60	
144305601	1/2"x3/4" - 6 bar	20	10/60	

IVR 759



NEW

Valvola miscelatrice termostatica a 3 vie per impianti solari - attacchi F/F/F
3-way thermostatic mixing valve for solar systems - F/F/F
3-Wege thermostatisches Mischventil für Solaranlagen - IG/IG/IG
Soupape de mélange à 3 voies thermostatique pour systèmes solaires - F/F/F
3-ходовой термостатический смесительный клапан для солнечных систем - соединения В/В/В

Cod./Code	DN	□/田	€
175905001	1/2"	1	
175907001	3/4"	1	
175910001	1"	1	

IVR 760

NEW



Valvola miscelatrice termostatica a 3 vie per impianti solari - attacchi M/M/M

3-way thermostatic mixing valve for solar systems - M/M/M

3-Wege thermostatisches Mischventil für Solaranlagen - AG/AG/AG

Soupape de mélange à 3 voies thermostatique pour systèmes solaires - M/M/M

3-ходовой термостатический смесительный клапан для солнечных систем - соединения Н/Н/Н

Cod./Code	DN	□/田	€
176007001	3/4"	1	
176010001	1"	1	

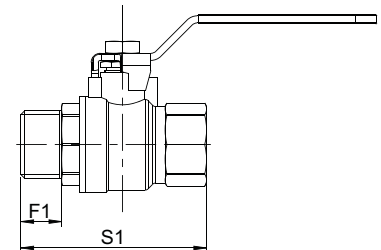
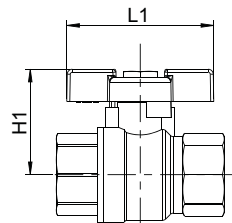
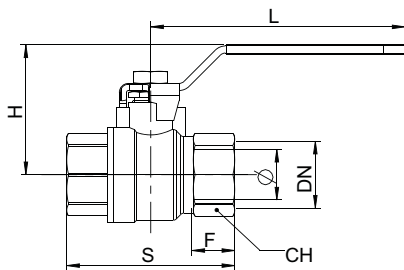

SOLAR

DIMENSIONI / DIMENSIONS

DN	Ø	S	S1	S2	L	L1	L2	L3	H	H1	H2	H3	F	F1	CH
3/8"	10	45	54		80	50			40	33			12	12	21
1/2"	15	63	70		90	61			52	39			17	15	26
3/4"	20	71	80		90	61			55	43			19,5	16	31
1"	25	83	92		125	72			64	52			21	19	38
1"1/4	32	92	102		125				69	57			22	20,5	48
1"1/2	40	104	117		140				78				23,5	21,5	55
2"	50	124	137		140				85				28	24,5	68

SOLAR

ACCESSORI / RICAMBI - ACCESSORIES / SPARE PARTS

	3/8"	1/2"	3/4"	1"	1"1/4	1"1/2	2"
	701604001	701614001	701614001	701624001	701624001	701634001	701634001
	703004001	703014001	703014001	703024001			
	750306001	750308001	750308001	750310001	750310001	750314001	750314001

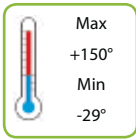

IVR NPT



IVR 607 NPT



Saracinesca PN16 - volantino in acciaio - attacchi F/F NPT
 Gate valve PN16 - handle in steel - F/F NPT
 Absperrventil PN16 - Handrad aus Stahl - IG/IG NPT
 Vanne à opercule PN16 - volant d'acier - F/F NPT
 Шиберный клапан PN16 - со стальным маховиком - соединения В/В NPT

Cod./Code	DN	□/▣	€
160705001	1/2"	20/80	
160707001	3/4"	20/80	
160710001	1"	12/48	
160712001	1"1/4	12/48	
160715001	1"1/2	8/32	
160720001	2"	2/8	



IVR DZR



50 bar

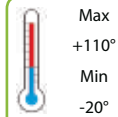

Max
+110°
Min
-20°



UNI ISO 228-1

IVR 20



Valvola a sfera a passaggio totale in DZR - attacchi F/F
 DZR brass full bore ball valve - threaded ends F
 Kugelhahn mit vollem Durchgang in DZR - IG/IG
 Vanne à boisseau sphérique à passage intégral in DZR - fixations F/F
 Полнопроходной шаровой кран из латуни DZR - соединения В/В

Cod./Code	DN	Ø	□/田	€
102003010	3/8"	10	10/120	
102005010	1/2"	15	20/80	
102007010	3/4"	20	20/80	
102010010	1"	25	12/48	
102012010	1"1/4	32	6/24	
102015010	1"1/2	40	4/16	
102020010	2"	50	4/16	



IVR 20/A





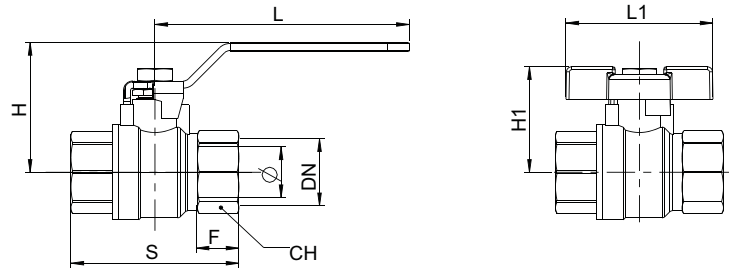

Valvola a sfera a passaggio totale in DZR - attacchi F/F
 DZR brass full bore ball valve - threaded ends F/F
 Kugelhahn mit vollem Durchgang in DZR - IG/IG
 Vanne à boisseau sphérique à passage intégral in DZR - fixations F/F
 Полнопроходной шаровой кран из латуни DZR - соединения В/В

Cod./Code	DN	Ø	□/田	€
102003011	3/8"	10	10/120	
102005011	1/2"	15	20/80	
102007011	3/4"	20	20/80	
102010011	1"	25	12/48	





DZR		DIMENSIONI / DIMENSIONS													
DN	Ø	S	S1	S2	L	L1	L2	L3	H	H1	H2	H3	F	F1	CH
3/8"	10	45			80	50			40	33			12		21
1/2"	15	55			90	61			52	39			13,5		25
3/4"	20	61			90	61			55	43			14,5		31
1"	25	72			125	72			64	52			16		38
1"1/4	32	81			125				69	57			17		47
1"1/2	40	94			140				78				18		54
2"	50	112			140				85				22		66

DZR		ACCESSORI / RICAMBI - ACCESSORIES / SPARE PARTS			
					
3/8"	700101001	703001501	750106001	109702030	
1/2"	700111001	703011501	750108001	109705030	
3/4"	700111001	703011501	750108001	109705030	
1"	700121001	703021501	750110001	109710030	
1"1/4	700121001		750110001	109710030	
1"1/2	700131001		750114001	109715030	
2"	700131001		750114001	109715030	



IVR 25



Valvola a sfera a passaggio totale in DZR - attacchi tubo rame compressione
 DZR brass full bore ball valve with compression ends for copper pipe
 Kugelhahn mit vollem Durchgang in DZR - Kompression-Anschlüsse für Kupferrohr
 Vanne à boisseau sphérique à passage intégral in DZR - fixations tube cuivre compression
 Полнопроходной шаровой кран из латуни DZR - компрессионные соединения для медной трубы



Cod./Code	DN	Ø	□/田	€
102505010	15	15	20/80	
102507010	22	20	20/80	
102510010	28	25	10/40	

IVR 25/A



Valvola a sfera a passaggio totale in DZR - attacchi tubo rame compressione
 DZR brass full bore ball valve with compression ends for copper pipe
 Kugelhahn mit vollem Durchgang in DZR - Kompression-Anschlüsse für Kupferrohr
 Vanne à boisseau sphérique à passage intégral in DZR - fixations tube cuivre compression
 Полнопроходной шаровой кран из латуни DZR - компрессионные соединения для медной трубы



Cod./Code	DN	Ø	□/田	€
102505011	15	15	20/80	
102507011	22	20	20/80	
102510011	28	25	10/40	

IVR 210 NORDICA



Valvola a sfera a passaggio totale in DZR con asta prolungata - attacchi F/F
 DZR brass full bore ball valve with extension stem - threaded ends F/F
 Kugelhahn mit vollem Durchgang in DZR mit verlängertem Spindel - IG/IG
 Vanne à boisseau sphérique à passage intégral in DZR avec tige rallonge - fixations F/F
 Полнопроходной шаровой кран из латуни DZR с удлиненным штоком - соединения В/В



Cod./Code	DN	Ø	□/田	€
121003010	3/8"	10	10/60	
121005010	1/2"	15	10/60	
121007010	3/4"	20	10/40	
121010010	1"	25	10/40	
121012010	1"1/4	32	4/16	
121015010	1"1/2	40	2/8	
121020010	2"	50	2/8	

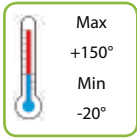

IVR NORDIKA

IVR 200 NORDIKA



Valvola a sfera a passaggio totale con asta prolungata - attacchi F/F
Brass full bore ball valve with extension stem - threaded ends F/F
Kugelhahn mit vollem Durchgang und verlängerter Spindel - IG/IG
Vanne à boisseau sphérique à passage intégral avec tige rallonge - fixations F/F
Полнопроходной шаровой кран с удлиненным штоком - соединения В/В

Cod./Code	DN	Ø	□/田	€
120005007	1/2"	15	10/60	
120007007	3/4"	20	10/40	
120010007	1"	25	10/40	
120012007	1"1/4	32	4/16	
120015007	1"1/2	40	2/8	
120020007	2"	50	2/8	
120025007	2" 1/2	60	1/6	

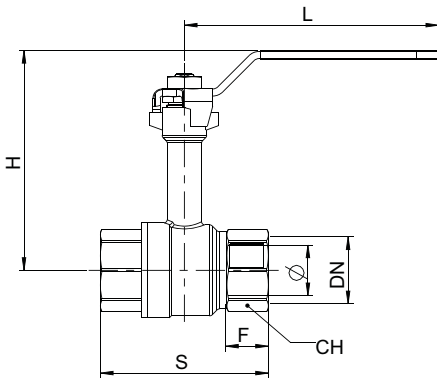

NORDIKA ACCESSORI / RICAMBI - ACCESSORIES / SPARE PARTS

		
1/2"	700111001	750108001
3/4"	700111001	750108001
1"	700121001	750110001
1"1/4	700121001	750110001
1"1/2	700131001	750114001
2"	700131001	750114001

NORDIKA

DIMENSIONI / DIMENSIONS

DN	Ø	S	S1	S2	L	L1	L2	L3	H	H1	H2	H3	F	F1	CH
1/2"	15	63			90				96				17		26
3/4"	20	71			90				100				19,5		31
1"	25	83			125				109				21		38
1"1/4	32	92			125				114				22		48
1"1/2	40	104			140				131				23,5		55
2"	50	124			140				139				28		68

IVR DRAIN

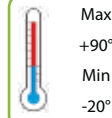

IVR 68 SPURGO



Valvola a sfera a passaggio totale con tappo e rubinetto di scarico - attacchi F/F
Full bore ball valve with cap and drain tap - threaded ends F/F
Kugelhahn mit vollem Durchgang, Deckel und Ablasshahn - IG/IG
Vanne à boisseau sphérique à passage intégral avec bouchon et robinet d'évacuation - fixations F/F
Полнопроходной шаровой клапан с заглушкой и спускным краником - соединения В/В

Cod./Code	DN	Ø	□/田	€
106805007	1/2"	15	10/60	
106807007	3/4"	20	20/80	
106810007	1"	25	12/48	
106812007	1"1/4	32	8/32	
106815007	1"1/2	40	4/16	
106820007	2"	50	4/16	



NOTA: Disponibile anche, con maniglia blu o nera
NOTE: Available with blue or black handle
ANMERKUNG: Erhältlich auch mit blauem oder schwarzem Griff
NOTE: Disponible, avec poignée bleu ciel ou noire
ПРИМЕЧАНИЕ: Доступен также с голубой или чёрной рукояткой

IVR 68/A SPURGO



Valvola a sfera a passaggio totale con tappo e rubinetto di scarico - attacchi F/F
Full bore ball valve with cap and drain tap - threaded ends F/F
Kugelhahn mit vollem Durchgang, Deckel und Ablasshahn - IG/IG
Vanne à boisseau sphérique à passage intégral avec bouchon et robinet d'évacuation - fixations F/F
Полнопроходной шаровой клапан с пробкой и дренажным краном - соединения В/В

Cod./Code	DN	Ø	□/田	€
106805002	1/2"	15	10/60	
106807002	3/4"	20	20/80	
106810002	1"	25	12/48	



NOTA: Disponibile anche, con farfalla blu o nera
NOTE: Available with blue or black butterfly handle
ANMERKUNG: Erhältlich auch mit hellblauem oder schwarzem Flügelgriff
NOTE: Disponible aussi, avec papillon bleu ciel ou noir
ПРИМЕЧАНИЕ: Доступен также с голубой или чёрной ручкой-бабочкой

IVR 69 SPURGO



Valvola a sfera a passaggio totale con tappo e rubinetto scarico - attacchi M/F
Full bore ball valve with cap and drain tap - threaded ends M/F
Kugelhahn mit vollem Durchgang, Deckel und Ablasshahn - AG/IG
Vanne à boisseau sphérique à passage intégral avec bouchon et robinet d'évacuation - fixations M/F
Полнопроходной шаровой кран с заглушкой и спускным краником - соединения Н/В

Cod./Code	DN	Ø	□/田	€
106905007	1/2"	15	10/60	
106907007	3/4"	20	20/80	
106910007	1"	25	12/48	



NOTA: Disponibile anche, con maniglia blu o nera
NOTE: Available with blue or black handle
ANMERKUNG: Erhältlich auch mit blauem oder schwarzem Griff
NOTE: Disponible, avec poignée bleu ciel ou noire
ПРИМЕЧАНИЕ: Доступен также с голубой или чёрной рукояткой

IVR 69/A SPURGO



Valvola a sfera a passaggio totale con tappo e rubinetto scarico - attacchi M/F
Full bore ball valve with cap and drain tap - threaded ends M/F
Kugelhahn mit vollem Durchgang, Deckel und Ablasshahn - AG/IG
Vanne à boisseau sphérique à passage intégral avec bouchon et robinet d'évacuation - fixations M/F
Полнопроходной шаровой кран с заглушкой и спускным краником - соединения Н/В

Cod./Code	DN	Ø	□/田	€
106905008	1/2"	15	10/60	
106907008	3/4"	20	20/80	
106910008	1"	25	12/48	



NOTA: Disponibile anche con farfalla azzurra o nera
NOTE: Available with blue or black butterfly handle
ANMERKUNG: Erhältlich auch mit hellblauem oder schwarzem Flügelgriff
NOTE: Disponible aussi, avec papillon bleu ciel ou noir
ПРИМЕЧАНИЕ: Доступен также с голубой или чёрной ручкой-бабочкой

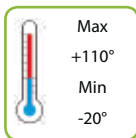

IVR BOCCHETTONE

IVR 60/A - 60/B BOCCHETTONE



Valvola a sfera a passaggio totale con bocchettone - attacchi M/F, sede conica
Full bore ball valve with tail piece - threaded ends M/F, conical seat
Kugelhahn mit vollem Durchgang und Rohrverschraubung - AG/IG, Kegelsitz
Vanne à boisseau sphérique à passage intégral avec raccord - fixations M/F, siège conique
Полнопроходной шаровой кран со сгоном и накидной гайкой - соединения Н/В, с коническим седлом



Cod./Code	Misura/Size	□/田	€
106005010	1/2" Rossa - Red	10/120	
106005311	1/2" Blu - Blue	10/120	
106007010	3/4" Rossa - Red	10/60	
106007311	3/4" Blu - Blue butterfly	10/60	
106010010	1" Rossa - Red	10/40	
106010311	1" Blu - Blue	10/40	
106012011	1"1/4 Rossa - Red	6/24	
106012311	1"1/4 Blu - Blue	6/24	

IVR 961/A - 961/B BOCCHETTONE A SQUADRA



Valvola a sfera a passaggio totale a squadra con bocchettone - attacchi M/F, sede conica
Angle full bore ball valve with tail piece - threaded ends M/F, conical seat
Kugelhahn mit vollem Durchgang, eckförmig, mit Stutzen Rohrverschraubung - AG/IG, Kegelsitz
Vanne à boisseau sphérique à passage intégral à équerre avec raccord - fixations M/F, siège conique
Полнопроходной угловой шаровой кран со сгоном и накидной гайкой - соединения Н/В, с коническим седлом



Cod./Code	Misura/Size	□/田	€
196105002	1/2" Rossa - Red	20/100	
196105311	1/2" Blu - Blue	20/100	
196107002	3/4" Rossa - Red	20/80	
196107311	3/4" Blu - Blue	20/80	
196110002	1" Rossa - Red	9/36	
196110311	1" Blu - Blue	9/36	

IVR ATTACCO SONDA

IVR 954 S



Valvola a sfera a passaggio totale - attacchi F/F - con portasonda
Full bore ball valve - threaded ends F/F - with sensor connection
Kugelhahn mit vollem Durchgang - IG/IG - mit Anschlüssen für Temperaturfühler
Vanne a sphère a passage total - fixations F/F - avec fixation sonde pour température
Полнопроходной шаровой кран: соединения В/В - с датчиком

Cod./Code	Misura/Size	□/田	€
195405711	1/2"	15/90	
195407711	3/4"	20/60	
195410711	1"	12/48	

IVR 944/2 AS

NEW



Con bocchettone. Sede conica M/F
With tailpiece. Conical seat M/F
Mit Rohrverschraubung. Kegelsitz AG/IG
Avec raccord de tuyauterie. Siège conique M/F
Со сгоном. Коническое седло. Соединения - Н/В

Cod./Code	Misura/Size	□/田	€
194407079	3/4" x 3/4"	M10 x 1 10/40	

IVR 809/A - 809/B BOCCHETTONE



Valvola a sfera M/F con bocchettone, termometro e attacco sonda per temperatura, sede conica
Ball valve M/F tail piece with thermometer and sensor connection, conical seat
Kugelhahn AG/IG, mit Rohrverschraubung, Thermometer und Anschluss für Temperaturfühler, Kegelsitz
Vanne à boisseau sphérique M/F avec raccord, thermomètre et fixation sonde pour température, siège conique
Шаровой кран с накидной гайкой - соединения Н/В для температурного сенсора, с коническим седлом

Cod./Code	Misura/Size	Ø	□/田	€
180910002	1" Red	23	10/40	
180910011	1" Blue	23	10/40	

IVR QUADRO

IVR 42 QUADRO 28



EAC

Valvola a sfera a passaggio totale - quadro di manovra 28mm - attacchi F/F
Full bore ball valve - square cap 28mm - threaded ends F/F
Kugelhahn mit vollem Durchgang - Schalttafel 28 mm - IG/IG
Vanne à boisseau sphérique à passage intégral - tableau de manoeuvre 28mm - fixations F/F
Полнопроходной шаровой кран - с квадратной головкой для управления 28 мм - соединения В/В

Cod./Code	DN	Ø	□/田	€
104205281	1/2"	15	10/60	
104207281	3/4"	20	10/40	
104210281	1"	25	10/40	
104212281	1"1/4	32	6/24	
104215281	1"1/2	40	5/20	
104220281	2"	50	2/8	

IVR 43 QUADRO 28



EAC

Valvola a sfera a passaggio totale - quadro di manovra 28mm - attacchi M/F
Full bore ball valve - square cap 28mm - threaded ends M/F
Kugelhahn mit vollem Durchgang - Schalttafel 28 mm - AG/IG
Vanne à boisseau sphérique à passage intégral - tableau de manoeuvre 28mm - fixations M/F
Полнопроходной шаровой кран - с квадратной головкой для управления 28 мм - соединения Н/В

Cod./Code	DN	Ø	□/田	€
104305281	1/2"	15	10/60	
104307281	3/4"	20	10/40	
104310281	1"	25	10/40	
104312281	1"1/4	32	6/24	
104315281	1"1/2	40	5/20	
104320281	2"	50	2/8	



IVR RIDUTTORE DI MANOVRA

IVR 137



Valvola a sfera a passaggio totale con riduttore di manovra - attacchi F/F
 Full bore ball valve with gear - threaded ends F/F
 Kugelhahn mit vollem Durchgang und Softgriff - IG/IG
 Vanne à boisseau sphérique à passage intégral avec réducteur de manoeuvre - fixations F/F
 Полнопроходной шаровой кран с ручкой-редуктором - соединения В/В

Cod./Code	DN	Ø	□/田	€
113702001	1/4"	10	15/60	
113703001	3/8"	10	15/60	
113705001	1/2"	15	9/36	
113707001	3/4"	20	8/32	
113710001	1"	25	8/32	
113712001	1"1/4	32	6/24	
113715001	1"1/2	40	2/8	
113720001	2"	50	2/8	
113725001	2"1/2	61	6	

ERC

IVR 137 R MANIGLIA - TAPPO



Maniglia senza tappo per valvola riduttore - Tappo per maniglia
 Handle for ball valve with geared-action without cap - Cap for handle
 "Soft-Griff" ohne Deckel für Reduzierventil - Deckel für den Griff
 Poignée sans bouchon pour vanne réducteur - Bouchon pour poignée
 Ручка без пробки для клапана с редуктором - Пробка для ручки

Cod./Code	Misura/Size	Per articoli/For items/Für Artikel/pour article /Для изделия	□/田	€
339003451	3/8"	137	1	
339005451	1/2"-3/4"	137	1	
339010451	1"-1"1/4	137	1	
339015451	1"1/2-2"	137	1	
339005452	1a MIS	1A MIS Orange - 137-157 - 3/8" - 1/2" - 3/4" - 1" - 1"1/4	1	
339010452	2a MIS	2A MIS Orange - 137-157 - 1"1/2 - 2"	1	

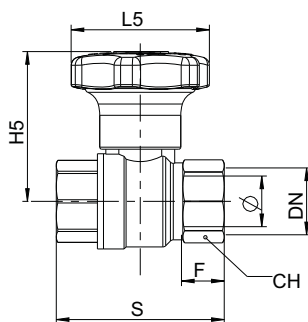

DIMENSIONI / DIMENSIONS

DN	Ø	S	L5	H5	F	CH
3/8"	10	45	70	59	12	21
1/2"	15	63	70	65	17	26
3/4"	20	71	70	68	19,5	31
1"	25	83	70	76	21	38
1"1/4	32	92	70	81	22	48
1"1/2	40	104	112	105	23,5	55
2"	50	124	112	112	28	68
2"1/2	60	140	112	162	28	85

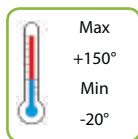
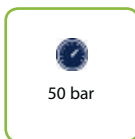

IVR TRE VIE

IVR 70 TRE VIE L



Valvola a sfera a tre vie a passaggio ridotto sfera forata a "L" - attacchi F/F/F
3-way valve with reduced bore and perforated ball type L - threaded ends F/F/F
3-Wege-Kugelhahn mit reduziertem Durchgang, Kugel mit L-Bohrung - IG/IG/IG
Vanne à boisseau sphérique à trois voies à passage réduit sphère percée en "L" - fixations F/F/F
Трехходовой шаровой кран с редуцированным проходом, сфера с «L» образным отверстием - соединения В/В/В

Cod./Code	DN	Ø	□/田	€
107002003	1/4"	10	5/30	
107003003	3/8"	10	5/30	
107005003	1/2"	12	3/18	
107007003	3/4"	15	2/12	
107010003	1"	20	2/12	
107012003	1"1/4	25	2/8	
107015003	1"1/2	32	1/5	
107020003	2"	40	1/5	



NOTA: Disponibile anche, con maniglia nera
NOTE: Available, with black handle
ANMERKUNG: Erhältlich auch mit schwarzem Griff
NOTE: Disponible, avec poignée noire
ПРИМЕЧАНИЕ: Доступен также с чёрной ручкой

IVR 71 TRE VIE T



Valvola a sfera a tre vie a passaggio ridotto sfera forata a T - attacchi F/F/F
3-way valve with reduced bore and perforated ball type T - threaded ends F/F/F
3-Wege-Kugelhahn mit reduziertem Durchgang, Kugel mit T-Bohrung -IG/IG/IG
Vanne à boisseau sphérique à trois voies à passage réduit sphère percée en T - fixations F/F/F
Трехходовой шаровой кран с редуцированным проходом, сфера с «Т» образным отверстием - соединения В/В/В

Cod./Code	DN	Ø	□/田	€
107102003	1/4"	10	5/30	
107103003	3/8"	10	5/30	
107105003	1/2"	12	3/18	
107107003	3/4"	15	2/12	
107110003	1"	20	2/12	
107112003	1"1/4	25	2/8	
107115003	1"1/2	32	1/5	
107120003	2"	40	1/5	



NOTA: Disponibile anche, con maniglia nera
NOTE: Available, with black handle
ANMERKUNG: Erhältlich auch mit schwarzem Griff
NOTE: Disponible, avec poignée noire
ПРИМЕЧАНИЕ: Доступен также с чёрной ручкой



IVR 72 TRE VIE L

NEW



EAC

Valvola a sfera a tre vie deviatrice a passaggio ridotto sfera forata a T - attacchi F/F/F

3-way diverter ball valve with reduced bore - type T - F/F/F

3-Wege Ableitventil mit reduziertem Durchgang mit T-Bohrung - IG/IG/IG

Vanne déviatrice à boisseau sphérique à 3 voies avec passage réduit, percée en T - F/F/F

Трехходовой распределительный кран с редуцированным проходом, сфера с "Т" образным отверстием, соединение В/В/В

Cod./Code	DN	Ø	□/田	€
107202001	1/4"	10	5/30	
107203001	3/8"	10	5/30	
107205001	1/2"	12	3/18	
107207001	3/4"	15	2/12	
107210001	1"	20	2/12	
107212001	1"1/4	25	2/8	
107215001	1"1/2	32	1/5	
107220001	2"	40	1/5	

IVR 73 TRE VIE T

NEW



EAC

Valvola a sfera a tre vie deviatrice a passaggio ridotto sfera forata a L - attacchi F/F/F

3-way diverter ball valve with reduced bore - type L - F/F/F

3-Wege Ableitventil mit reduziertem Durchgang mit L-Bohrung - IG/IG/IG

Vanne déviatrice à boisseau sphérique à 3 voies avec passage réduit, percée en L - F/F/F

Трехходовой распределительный кран с редуцированным проходом, сфера с "L" образным отверстием, соединение В/В/В

Cod./Code	DN	Ø	□/田	€
107302001	1/4"	10	5/30	
107303001	3/8"	10	5/30	
107305001	1/2"	12	3/18	
107307001	3/4"	15	2/12	
107310001	1"	20	2/12	
107312001	1"1/4	25	2/8	
107315001	1"1/2	32	1/5	
107320001	2"	40	1/5	

IVR 63 VALVOLA YPSILON



ACS

EAC

Valvola a sfera a passaggio totale a Y - attacchi F/F/F

Full bore ball valve type Y - threaded ends F/F/F

Y-förmigem Kugelhahn, vollem Durchgang - IG/IG/IG

Vanne à boisseau sphérique à passage intégral en Y - fixations F/F/F

Полнопроходной шаровой кран тип "Y" - соединения В/В/В

Cod./Code	DN	Ø	□/田	€
106305001	1/2" x 3/8"	15	5/20	
106307001	3/4" x 1/2"	15	5/20	
106310001	1" x 3/4"	20	2/8	
106312001	1"1/4 x 1"	20	2/8	



10 bar

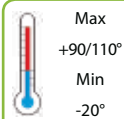

Max
+90/110°
Min
-20°



UNI ISO 228-1

IVR VALVOLE ATTACCO POMPA

IVR 108



Valvola a sfera con filetto F e con calotta per attacco pompa e circolatori

Ball valve with F thread and loose nut for pump connection

Pumpen-Kugelhahn mit IG - Überwurfmutter

Vanne à boisseau sphérique avec écrou tournant pour pompe

Шаровой кран с внутренней резьбой и накидной гайкой для соединения с циркуляционным насосом



Cod./Code	DN	Ø	□/田	€
110810001	1" F x 1"1/2 F	18,5	100	

IVR 109



Valvola a sfera con attacco tubo rame e calotta per attacco pompa e circolatori

Ball valve with copper connection and loose nut for pump connection

Pumpen-Kugelhahn mit Kompression-Anschluss für Kupferrohr und Überwurfmutter

Vanne à boisseau sphérique avec raccord à compression pour tube cuivre et écrou tournant pour pompe

Шаровой кран для насосов с соединением для медной трубы и накидной гайкой для соединения с насосом



Cod./Code	DN	Ø	□/田	€
110900221	22 x 1"1/2 F	18,5	100	
110900281	28 x 1"1/2 F	18,5	100	

IVR 380



Valvola a sfera con filetto F e con calotta per attacco pompa e circolatori

Ball valve with F thread and loose nut for pump connection

Pumpen-Kugelhahn - IG - Überwurfmutter

Vanne à boisseau sphérique avec écrou tournant pour pompe

Шаровой кран для насосов с соединением для медной трубы и накидной гайкой для соединения с циркуляционным насосом



Cod./Code	DN	Ø	□/田	€
138010002	1" F x 1"1/2 F	20	10/40	



IVR 381



Valvola a sfera con filetto F e con calotta + ritegno per attacco pompa e circolatori
Ball valve with F thread and loose nut + anti-return for pump connection
Pumpenkugelhahn IG und Überwurfmutter + Schwerkraftbremse für Pumpe und Zirkulatoren
Vanne à boisseau sphérique avec fixation F et écrou tournant + anti-retour pour fixation pompe et circulateurs
Шаровой кран с внутренней резьбой и накидной гайкой + обратный клапан для соединения с циркуляционным насосом



Cod./Code	DN	Ø	□/田	€
138110002	1" F x 1"1/2 F	20	10/40	

IVR 382



Valvola a sfera con filetto F e con calotta + ritegno (disattivabile) per attacco pompa e circolatori
Ball valve with F thread and loose nut + anti-return (disactivable) for pump connection and circulators
Pumpenkugelhahn IG und Überwurfmutter + abschaltbarer Schwerkraftbremse für Pumpe und Zirkulatoren
Vanne à boisseau sphérique avec fixation F et écrou tournant + anti-retour (désactivable) pour pompe et circulateurs
Шаровой кран с внутренней резьбой и накидной гайкой + обратный клапан (отключаемый) для соединения с циркуляционным насосом



Cod./Code	DN	Ø	□/田	€
138210002	1" F x 1"1/2 F	20	10/40	

IVR 650 SARACINESCA PER POMPE



Valvola a saracinesca con attacco tubo rame e calotta per attacco pompa e circolatori
Gate valve with copper connection and loose nut for pump connection
Absperrschieber für Pumpen - Anschlüsse für Kupferrohr
Vanne à passage direct avec raccord à compression pour tube cuivre et écrou tournant pour pompe
Шибберный клапан с соединением для медной трубы и накидной гайкой для соединения с циркуляционным насосом



Cod./Code	DN	Ø	□/田	€
165022001	22 x 1"1/2 F		50	
165028001	28 x 1"1/2 F		50	

IVR 395 C



Calotta in ottone nichelata per valvole IVR 395 e IVR 396
Nickel-plated loose nut for valves IVR 395 and IVR 396
Vernickelte Überwurfmutter für Ventile IVR 395 und IVR 396
Écrou tournant nickelé pour les vannes IVR 395 et IVR 396
Гайка из никелированной латуни для кранов IVR 395 и IVR 396

Cod./Code	DN	Ø	□/田	€
228215100	1"1/2		8/64	

IVR 392

NEW



Valvola a sfera in ottone con maniglia a T, attacchi F/F

Ball valve in brass with T handle, F/F

Kugelventil aus Messing mit T-Handgriff, IG/IG

Vanne à boisseau sphérique en laiton avec poignée en T, F/F

Шаровой кран из латуни с Т образной ручкой, соединения В/В

Cod./Code	DN	□/田	€
139205001	1/2"	20/100	
139207001	3/4"	15/60	
139210001	1"	12/48	
139212001	1" 1/4	6/36	
139215001	1" 1/2	6/24	

IVR 393

NEW



Valvola a sfera in ottone con maniglia a T, attacchi M/F

Ball valve in brass with T handle, M/F

Kugelventil aus Messing mit T-Handgriff, AG/IG

Vanne à boisseau sphérique en laiton avec poignée en T, M/F

Шаровой кран из латуни с Т образной ручкой, соединения Н/В

Cod./Code	DN	□/田	€
139305001	1/2"	20/100	
139307001	3/4"	15/60	
139310001	1"	12/48	
139312001	1" 1/4	6/36	
139315001	1" 1/2	6/24	

IVR 395

NEW



Valvola a sfera in ottone con maniglia a T, con attacco pompa

Ball valve in brass with T handle, with pump connection

Kugelventil aus Messing mit T-Handgriff und Pumpenverbindung

Vanne à boisseau sphérique en laiton avec poignée en T et fixation pour pompe

Шаровой кран из латуни с Т образной ручкой, с соединением для насоса

Cod./Code	DN	□/田	€
139510151	1" x 1" 1/2	8/64	
139512151	1" 1/4 x 1" 1/2	8/64	

IVR 396

NEW



Valvola a sfera in ottone con maniglia a T, con attacco pompa, con ritegno

Ball valve in brass with T handle, with pump connection and anti-return

Kugelventil aus Messing mit T-Handgriff, mit Pumpenverbindung und Schwerkraftbremse

Vanne à boisseau sphérique en laiton avec poignée en T, fixation pour pompe et anti-retour

Шаровой кран из латуни с Т образной ручкой, с соединением для насоса и обратным клапаном

Cod./Code	DN	□/田	€
139610151	1" x 1" 1/2	8/64	
139612151	1" 1/4 x 1" 1/2	8/64	

IVR IDRETTO

IVR 966



Rubinetto a sfera con portagomma
 Bibcock with hose connection
 "Garten-Wasserhahn" mit Schlauchanschluss
 Robinet de puisage simple avec poignée plate
 Поливочный кран с насадкой для шланга



Cod./Code	DN	Ø	□/田	€
196603001	3/8"	10	25/100	
196605001	1/2"	15	25/100	
196607001	3/4"	20	16/64	
196610001	1"	25	8/48	

IVR 966/A



Rubinetto a sfera con portagomma
 Bibcock with hose connection
 "Garten-Wasserhahn" mit Schlauchanschluss
 Robinet de puisage simple avec poignée papillon
 Поливочный кран с насадкой для шланга



Cod./Code	DN	Ø	□/田	€
196603002	3/8"	10	25/100	
196605002	1/2"	15	25/100	
196607002	3/4"	20	16/64	
196610002	1"	25	8/48	

IVR MIGNON

IVR 925 STAMPATA



Mini valvola mignon - attacchi F/F
Mini-valve mignon - threaded ends F/F
Kugelhahn Mignon - IG/IG - erhältlich mit schwarzem, rotem oder blauem Griff
Mini vanne mignon - fixations F/F
Мини шаровой кран "мигньон" - соединения В/В

EAC

Cod./Code	DN	Ø	□/田	€
192502001	1/4"	8	60/300	
192503001	3/8"	8	60/300	
192505001	1/2"	10	50/250	

IVR 926 STAMPATA



Mini valvola mignon - attacchi M/F
Mini-valve mignon - threaded ends M/F
Kugelhahn Mignon - AG/IG - erhältlich mit schwarzem, rotem oder blauem Griff
Mini vanne mignon - fixations M/F
Мини шаровой кран "мигньон" - соединения Н/В

EAC

Cod./Code	DN	Ø	□/田	€
192602001	1/4"	8	60/300	
192603001	3/8"	8	60/300	
192605001	1/2"	10	50/250	

IVR 927 BARRA



Mini valvola mignon - attacchi F/F
Mini-valve mignon - threaded ends F/F
Kugelhahn Mignon - IG/IG
Mini vanne mignon - fixations F/F
Шаровой кран типа "мигньон" - Соединения В/В

EAC

Cod./Code	DN	Ø	□/田	€
192701001	1/8"	6	60/300	
192702001	1/4"	8	60/300	
192703001	3/8"	8	60/300	
192705001	1/2"	10	50/250	

IVR 928 BARRA



Mini valvola mignon - attacchi M/F
 Mini-valve mignon - threaded ends M/F
 Kugelhahn Mignon - AG/IG
 Mini vanne mignon - fixations M/F
 Мини шаровой кран "миньон" - соединения Н/В



Cod./Code	DN	Ø	□/田	€
192801001	1/8"	6	60/300	
192802001	1/4"	8	60/300	
192803001	3/8"	8	60/300	
192805001	1/2"	10	50/250	

IVR 129



Mini valvola mignon - attacchi M/M
 Mini-valve mignon - threaded ends M/M
 Kugelhahn Mignon - AG/AG
 Mini vanne mignon - fixations M/M
 Мини шаровой кран "миньон" - соединения Н/Н



Cod./Code	DN	Ø	□/田	€
112901001	1/8"	6	60/300	
112902001	1/4"	8	60/300	
112903001	3/8"	8	60/300	
112905001	1/2"	10	50/250	

IVR SCARICO CALDAIA

IVR 904



ERC

Rubinetto per scarico caldaia completo di tappo - attacchi M - portagomma
Boiler blow-off valve with hose connection and cap - M threaded
KFE-Hahn (Kessel Füll- und Entleerungshahn) mit Deckel - AG - Schlauchanschluss
Robinet d'évacuation chaudière avec bouchon - fixations M - porte tuyau souple - Poignée noire
Сливной кран для котла в комплекте с насадкой для шланга и заглушкой - резьбовое соединение H

Cod./Code	DN	Ø	□/⊞	€
190403001	3/8" x 3/4"	8	40/160	
190405001	1/2" x 3/4"	10	40/160	
190407001	3/4" x 1"	15	20/100	

IVR 905



ERC

Rubinetto per scarico caldaia completo di tappo - attacchi M - portagomma
Boiler blow-off valve with hose connection and cap - M threaded
KFE-Hahn (Kessel Füll- und Entleerungshahn) mit Deckel - AG - Schlauchanschluss
Robinet d'évacuation chaudière avec bouchon - fixations M - porte tuyau souple - poignée rouge et joint étanchéité
Сливной кран для котла в комплекте с насадкой для шланга и заглушкой - резьбовое соединение H

Cod./Code	DN	Ø	□/⊞	€
190505001	1/2" x 3/4"	10	20/100	

IVR 103 SCARICO CALDAIA PESANTE



ERC

Rubinetto per scarico caldaia serie pesante con quadro di manovra e cappuccio con chiave incorporata - attacco F
Boiler blow off valve heavy type with hose connection and cap. F Threaded
KFE-Hahn (Kessel Füll- und Entleerungshahn) - schwere Ausführung - mit Schalttafel und Deckel - IG - Schlauchanschluss - mit integriertem Schlüssel
Robinet d'évacuation chaudière série lourde avec tableau de manoeuvre et capuchon à clé intégrée - fixation F
Усиленный сливной кран для котла, с квадратной управляющей головкой и крышкой со встроенным ключом - резьбовое соединение B

Cod./Code	DN	Ø	□/⊞	€
110305001	1/2" x 3/4"	10	10/60	
110307001	3/4" x 1"	15	10/60	
110310001	1"	25	10/60	

IVR 105 SCARICO CALDAIA PESANTE



ERC

Rubinetto per scarico caldaia serie pesante con quadro di manovra e cappuccio con chiave incorporata - attacco M
Boiler blow off valve heavy type with hose connection and cap. M Threaded
KFE-Hahn (Kessel Füll- und Entleerungshahn) - schwere Ausführung - mit Schalttafel und Deckel - AG - Schlauchanschluss - mit integriertem Schlüssel
Robinet d'évacuation chaudière série lourde avec tableau de manoeuvre et capuchon à clé intégrée - fixation M
Усиленный сливной кран для котла, с квадратной управляющей головкой и крышкой со встроенным ключом - резьбовое соединение H

Cod./Code	DN	Ø	□/⊞	€
110505001	1/2" x 3/4"	10	10/60	
110507001	3/4" x 1"	15	10/60	
110510001	1"	25	10/60	



IVR RUBINETTI

IVR 136 RUBINETTO LAVATRICE



Rubinetto per lavatrice - attacchi M/M
 Washing machine valve - threaded ends M/M
 Wasserhahn für Waschmaschine - AG/AG
 Robinet machine à laver - fixations M/M
 Кран для стиральной машины - соединения Н/Н



Cod./Code	DN	Ø	□/田	€
113603001	3/8" x 3/4"	9	120	
113605001	1/2" x 1/2"	9	100	
113607001	1/2" x 3/4"	9	100	

IVR 136/A RUBINETTO LAVATRICE



Rubinetto per lavatrice - attacchi M/M
 Washing machine valve - threaded ends M/M
 Wasserhahn für Waschmaschine - AG/AG
 Robinet machine à laver - fixations M/M
 Кран для стиральной машины - соединения Н/Н



Cod./Code	DN	Ø	□/田	€
113603002	3/8" x 3/4"	9	120	
113605002	1/2" x 1/2"	9	100	
113607002	1/2" x 3/4"	9	100	

IVR 297 RUBINETTO SOTTOLAVABO



Rubinetto sottolavabo con rosone, tipo corto - attacchi M/M
 Angle ball valve with rosette, short type - threaded ends M/M
 Eckregulierventil mit Rosette, kurze Ausführung - AG/AG
 Robinet sous lavabo avec rosace, type court - fixations M/M
 Кран укороченного типа с декоративной накладкой под умывальник - соединения Н/Н



Cod./Code	Misura/Size	□/田	€
129703051	3/8" x 1/2" L. 82,5 mm	2/180	
129705051	1/2" x 1/2" L. 82,5 mm	2/180	

IVR 299 RUBINETTO SOTTOLAVABO



Rubinetto sottolavabo con rosone, tipo lungo - attacchi M/M
 Angle ball valve with rosette, long type - threaded ends M/M
 Eckregulierventil mit Rosette, lange Ausführung - AG/AG
 Robinet sous lavabo avec rosace, type long - fixations M/M
 Кран удлиненного типа с декоративной накладкой под умывальник - соединения Н/Н



Cod./Code	Misura/Size	□/田	€
129903051	3/8" x 1/2" L. 93,5 mm	2/240	
129905051	1/2" x 1/2" L. 93,5 mm	2/240	

IVR INCASSO

IVR 130 INCASSO A LEVA



Valvola a sfera per incasso a passaggio totale con leva - attacchi F/F
Full bore ball valve with handle and rosette for in-wall installations. Threaded ends F/F
Unterputzkugelhahn mit vollem Durchgang - Handhebel - IG/IG
Vanne à boisseau sphérique avec poignée et rosette pour installation dans le mur. Fixations F/F
Полнопроходной шаровой кран с ручкой-флажком, встраиваемый в стену - соединения В/В



Cod./Code	DN	Ø	□/田	€
113005001	1/2"	15	8	
113007001	3/4"	20	6	
113010001	1"	25	5	

IVR 134 INCASSO A MANIGLIA



Valvola a sfera per incasso a passaggio totale con manopola - attacchi F/F
Full bore ball valve with handle and rosette for in-wall installations. Threaded ends F/F
Unterputzkugelhahn mit vollem Durchgang - Drehknopf - IG/IG
Vanne à boisseau sphérique avec poignée et rosette pour installation dans le mur. Fixations F/F
Полнопроходной шаровой кран с поворотной ручкой, встраиваемый в стену - соединения В/В



Cod./Code	DN	Ø	□/田	€
113405001	1/2"	15	6	
113407001	3/4"	20	5	
113410001	1"	25	4	

IVR 135 INCASSO A CAPPuccio



Valvola a sfera per incasso a passaggio totale con cappuccio - attacchi F/F
Full bore ball valve with cap for in-wall installations. Threaded ends F/F
Unterputzkugelhahn mit vollem Durchgang - Kappe - IG/IG
Vanne a boisseau sphérique avec capuchon pour installation dans le mur. Fixations F/F
Полнопроходной шаровой кран с конусным колпачком, встраиваемый в стену - соединения В/В



Cod./Code	DN	Ø	□/田	€
113505001	1/2"	15	10	
113507001	3/4"	20	5	
113510001	1"	25	5	



IVR VALVOLAME

IVR 993 TG RITEGNO



Valvola di ritegno a clapet con tenuta gomma
Swing check valve with rubber seat
Rückschlagventil mit Klappe mit Gummidichtung
Vanne à clapet avec tenue en gomme
Обратный клапан clapet с резиновым уплотнением

Cod./Code	Ø	□/田	€
199305100	1/2"	18/144	
199307100	3/4"	10/120	
199310100	1"	8/72	
199312100	1 1/4"	6/36	
199315100	1 1/2"	4/24	
199320100	2"	3/18	
199325100	2 1/2"	12	
199330100	3"	8	
199340100	4"	4	



IVR 993 TM RITEGNO



Valvola di ritegno a clapet con tenuta metallica
Swing check valve with metallic seat
Rückschlagventil mit Klappe mit Metaldichtung
Vanne à clapet avec tenue en métal
Обратный клапан clapet с металлическим уплотнением

Cod./Code	Ø	□/田	€
199305001	1/2"	18/144	
199307001	3/4"	10/120	
199310001	1"	8/72	
199312001	1 1/4"	6/36	
199315001	1 1/2"	4/24	
199320001	2"	3/18	
199325001	2 1/2"	12	
199330001	3"	8	
199340001	4"	4	



IVR 994 FONDO



Valvola di fondo
Foot valve
Fussventil
Crépine vertical
Донный клапан

Cod./Code	DN	□/田	€
199405001	1/2"	15/180	
199407001	3/4"	18/108	
199410001	1"	18/108	
199412001	1 1/4"	8/48	
199415001	1 1/2"	4/24	
199420001	2"	3/18	
199425001	2 1/2"	16	
199430001	3"	12	
199440001	4"	5	



IVR 90 FONDO

NEW



Valvola di fondo tubolare
Cylindrical foot valve
Zylinderfussventil
Crépine verticale cylindrique
Трубчатый донный клапан

Cod./Code	DN	□/田	€
109007001	3/4"	40	
109010001	1"	20	
109012001	1"1/4	20	
109015001	1"1/2	10	
109020001	2"	8	
109025001	2"1/2	1	
109030001	3"	1	
109040001	4"	1	

IVR 98 FILTRO



Filtro inox con raccordo in ottone
Stainless steel mesh filter with brass connection
Nirostahlfiter mit Messing-Gewinde
Filtre inox avec raccord en laiton
Фильтр из нержавеющей стали с латунным соединением

Cod./Code	DN	□/田	€
109803001	3/8"	50	
109805001	1/2"	35/210	
109807001	3/4"	20/120	
109810001	1"	25/100	
109812001	1"1/4	20/120	
109815001	1"1/2	10/60	
109820001	2"	6/36	
109825001	2"1/2	20	
109830001	3"	10	
109840001	4"	6	

EAC

IVR 995 L FILTRO



Filtro inox con raccordo in nylon
Stainless steel mesh filter with nylon connection
Nirostahlfiter mit Nylon-Gewinde
Crépine seule
Фильтр из нержавеющей стали с соединением из нейлона

Cod./Code	DN	□/田	€
199505001	1/2"	18/324	
199507001	3/4"	20/240	
199510001	1"	12/144	
199512001	1"1/4	15/90	
199515001	1"1/2	8/48	
199520001	2"	3/18	
199525001	2"1/2	24	
199530001	3"	18	
199540001	4"	4	

EAC



IVR 999 H RITEGNO



Valvola di ritegno tipo pesante con otturatore in acciaio inox
Check valve heavy type with inox shutter
Rückschlagventil, schwere Ausführung, mit Edelstahlklappe
Clapet de non retour avec obturateur inox
Усиленный обратный клапан с затвором из нержавеющей стали

Cod./Code	DN	□/田	€
199903100	3/8"	20/120	
199905100	1/2"	20/120	
199907100	3/4"	12/96	
199910100	1"	15/60	
199912100	1"1/4	8/40	
199915100	1"1/2	6/30	
199920100	2"	3/18	
199925100	2"1/2	6	
199930100	3"	4	
199940100	4"	3	



IVR 999 L RITEGNO



Valvola di ritegno con otturatore in nylon
Check valve with nylon shutter
Rückschlagventil, schwere Ausführung, mit Edelstahlklappe
Clapet de non retour avec obturateur en nylon
Обратный клапан с затвором из нейлона

Cod./Code	DN	□/田	€
199903001	3/8"	20/240	
199905001	1/2"	20/120	
199907001	3/4"	15/150	
199910001	1"	12/96	
199912001	1"1/4	6/72	
199915001	1"1/2	8/48	
199920001	2"	3/18	
199925001	2"1/2	16	
199930001	3"	12	
199940001	4"	4	



IVR 923 RITEGNO



Valvola di ritegno con filtro inox incorporato
Check valve with built - in filter
Rückschlagventil mit eingebautem Edelstahlfilter
Vanne de retenue avec filtre inox intégré
Обратный клапан с сетчатым фильтром из нержавеющей стали

Cod./Code	DN	□/田	€
192305001	1/2"	20/120	
192307001	3/4"	18/108	
192310001	1"	15/90	
192312001	1"1/4	3/36	
192315001	1"1/2	3/36	
192320001	2"	3/12	
192325001	2"1/2	12	
192330001	3"	8	
192340001	4"	5	



IVR 924 RACCOGLITORE DI IMPURITÀ



Raccoglitore di impurità a Y, filtro in acciaio inox AISI 304 - attacchi F/F

Y strainer with mesh in inox AISI 304 - threaded ends F/F

Y-förmigem Schmutzfänger aus Messing mit Filter aus rostfreiem Edelstahl AISI 304 - IG

Raccord filtre à tamis incliné en Y avec filtre en inox AISI 304 - fixations F/F

Латунный фильтр "Y" образный из нержавеющей стали AISI 304 - соединения В/В

Cod./Code	DN	□/田	€
192402001	1/4"	20/120	
192403001	3/8"	20/120	
192405001	1/2"	20/180	
192407001	3/4"	20/120	
192410001	1"	15/90	
192412001	1"1/4	6/36	
192415001	1"1/2	2/24	
192420001	2"	2/12	
192425001	2"1/2	10	
192430001	3"	8	
192440001	4"	4	



IVR SARACINESCHE

IVR 140



Saracinesca PN 20 - attacchi F/F
 Gate valve PN 20 - threaded ends F/F
 Muffen-Absperrschieber PN 20 - IG/IG
 Vanne à passage direct PN 20 - fixations F/F
 Шиберный клапан PN 20 - Соединения В/В

Cod./Code	DN	□/⊕	€
114002001	1/4"	20/120	
114003001	3/8"	20/120	
114005001	1/2"	20/120	
114007001	3/4"	10/60	
114010001	1"	10/60	
114012001	1"1/4	10/60	
114015001	1"1/2	5/30	
114020001	2"	5/25	
114025001	2"1/2	10	
114030001	3"	5	
114040001	4"	4	

ERC

IVR 605



Saracinesca PN 16 - attacchi F/F
 Gate valve PN 16 - threaded ends F/F
 Muffen-Absperrschieber PN 16 - IG/IG
 Vanne à passage direct PN 16 - fixations F/F
 Шиберный клапан PN 16 - Соединения В/В

Cod./Code	DN	□/⊕	€
160502010	1/4"	20/120	
160503010	3/8"	20/120	
160505010	1/2"	20/120	
160507010	3/4"	20/120	
160510010	1"	20/80	
160512010	1"1/4	10/60	
160515010	1"1/2	5/20	
160520010	2"	5/10	
160525001	2"1/2	10	
160530001	3"	10	
160540001	4"	4	
160550010	5"	2	
160560010	6"	2	

ERC

IVR 600



Saracinesca PN 10 - attacchi F/F
 Gate valve PN 10 - threaded ends F/F
 Muffen-Absperrschieber PN 10 - IG/IG
 Vanne à passage direct PN 10 - fixations F/F
 Шиберный клапан PN 10 - Соединения В/В

Cod./Code	DN	□/⊕	€
160005333	1/2"	20/120	
160007333	3/4"	20/80	
160010333	1"	15/60	
160012333	1"1/4	10/40	
160015333	1"1/2	12/48	
160020333	2"	3/12	

ERC

IVR 620 SARACINESCA BS 5154



Saracinesca BS 5154 - Attacchi tubo rame compressione - (a richiesta: attacchi per tubo rame irlandese)
Gate valve BS 5154 with compression ends for copper pipe - (Irish pipe connections available on request)
Muffen-Absperrschieber BS 5154 - Kompressionsanschluss für Kupferrohr - (auf Anfrage: Anschlüsse für irländisches Kupferrohr)
Vanne à passage direct BS 5154 - Fixations tube cuivre compression - (sur demande: fixations pour tube en cuivre irlandais)
Шиберный клапан BS 5154 - с компрессионными соединениями для медной трубы - (под заказ: соединения для ирландской медной трубы)

ERC

Cod./Code	DN	□/田	€
162015001	15	100	
162022001	22	50	
162028001	28	50	

IVR 650 SARACINESCA PER POMPE



Saracinesca per pompe - attacchi tubo rame
Pump brass gate valve for copper pipe
Muffen-Absperrschieber für Pumpen - Anschlüsse für Kupferrohr
Vanne à passage direct pour pompe - fixations tube en cuivre
Шиберный клапан для насосов - для медной трубы

ERC

Cod./Code	DN	□/田	€
165022001	22	50	
165028001	28	50	

IVR 607 NPT

NEW



Saracinesca PN16 - volantino in acciaio - attacchi F/F NPT
Gate valve PN16 - handle in steel - F/F NPT
Absperrventil PN16 - Handrad aus Stahl - IG/IG NPT
Vanne à opercule PN16 - volant d'acier - F/F NPT
Шиберный клапан PN16 - со стальным маховиком - соединения В/В NPT

ERC

Cod./Code	DN	□/田	€
160705001	1/2"	20/80	
160707001	3/4"	20/80	
160710001	1"	12/48	
160712001	1"1/4	12/48	
160715001	1"1/2	8/32	
160720001	2"	2/8	

IVR RIDUTTORE DI PRESSIONE

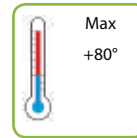
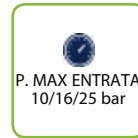

IVR 302 RIDUTTORE DI PRESSIONE COMPACT



Riduttore di pressione in ottone nichelato - attacchi F/F
Pressure reducing valve nickel-plated. F/F threaded ends
Druckminderer aus vernickeltem Messing - IG/IG
Réducteur de pression F/F en laiton nickelé - Taraudage F/F
Редуктор давления из никелированной латуни. Соединения В/В



Cod./Code	DN	□/田	€
130205100	1/2"	1/50	

IVR 304 RIDUTTORE DI PRESSIONE MINI



Riduttore di pressione in ottone nichelato - attacchi F/F - con attacco manometro 1/4"
Pressure reducing valve nickel-plated - threaded ends F/F - with pressure gauge connection 1/4"
Druckminderer aus vernickeltem Messing - IG/IG - mit Manometeranschluss 1/4"
Réducteur de pression en laiton nickelé - fixations F/F - avec fixation manomètre 1/4"
Редуктор давления из никелированной латуни - соединения В/В - с соединением для манометра 1/4"



Cod./Code	DN	□/田	€
130403001	3/8"	1/50	
130405001	1/2"	1/50	
130407001	3/4"	1/50	

Per manometri vedi pagina 215
For pressure gauges see page 215

IVR 305 RIDUTTORE DI PRESSIONE



Riduttore di pressione in ottone nichelato - attacchi F/F - con attacco manometro 1/4"
Pressure reducing valve nickel-plated - threaded ends F/F - with pressure gauge connection 1/4"
Druckminderer aus vernickeltem Messing - IG/IG - mit Manometeranschluss 1/4"
Réducteur de pression en laiton nickelé - fixations F/F - avec fixation manomètre 1/4"
Редуктор давления из никелированной латуни - соединения В/В - с соединением для манометра 1/4"



Cod./Code	DN	□/田	€
130505001	1/2"	1/24	
130507001	3/4"	1/15	
130510001	1"	1/10	
130512001	1"1/4	1/10	
130515001	1"1/2	1/10	
130520001	2"	1/5	
130525001	2"1/2	1	
130530001	3"	1	

Per manometri vedi pagina 215
For pressure gauges see page 215

IVR 303 RIDUTTORE DI PRESSIONE



Riduttore di pressione con sede in acciaio inox - bocchettoni F/F - con attacco manometro 1/4"
Pressure reducing valve with stainless steel seat - tail piece F/F - with pressure gauge connection 1/4"
Druckminderer mit Sitz aus Edelstahl - IG/IG - mit Manometeranschluss 1/4"
Réducteur de pression avec siège en acier inox - fixations F/F - avec fixation manomètre 1/4"
Редуктор давления со седлом из нержавеющей стали, соединения с накидной гайкой В/В - с соединением для манометра 1/4"

Cod./Code	DN	□/田	€
130305001	1/2"	1/24	
130307001	3/4"	1/15	
130310001	1"	1/10	
130312001	1"1/4	1/10	
130315001	1"1/2	1/6	
130320001	2"	1/4	



Per manometri vedi pagina 215
For pressure gauges see page 215

IVR 300 RIDUTTORE DI PRESSIONE



Riduttore di pressione con sede in acciaio inox - bocchettoni M/M - con attacco manometro 1/4"
Pressure reducing valve with stainless steel seat - tail piece M/M - with pressure gauge connection 1/4"
Druckminderer mit Sitz aus Edelstahl - AG/AG - mit Manometeranschluss 1/4"
Réducteur de pression avec siège en acier inox - fixations M/M - avec fixation manomètre 1/4"
Редуктор давления со седлом из нержавеющей стали - соединения с накидной гайкой Н/Н - с соединением для манометра 1/4"

Cod./Code	DN	□/田	€
130005001	1/2"	1/24	
130007001	3/4"	1/15	
130010001	1"	1/10	
130012001	1"1/4	1/10	
130015001	1"1/2	1/10	
130020001	2"	1/5	



Per manometri vedi pagina 215
For pressure gauges see page 215

IVR 306 COLPO D'ARIETE



Ammortizzatore del colpo d'ariete
Water hammer arrestor
Wasserrückschlagdämpfer
Amortisseur du coup de bélier
Амортизатор гидравлического удара



Cod./Code	DN	□/田	€
130605001	1/2" nichelata	10/40	
130605002	1/2" gialla	10/40	

IVR RACCORDERIA

IVR 312 P RACCORDO SEDE PIANA



EAC

Raccordo diritto in due pezzi a sede piana con guarnizione
2 pieces union end with gasket
Anschlussstück mit gerader Verschraubung, zweiteilig, mit Flachsitz und Dichtung
Raccord droit en deux pièces à siège plat avec joint
Двухсоставной прямой соединительный фитинг с плоским седлом и уплотнением

Cod./Code	DN	□/田	€
131205002	1/2" x 3/4"	50/200	
131207002	3/4" x 1"	50/200	
131210002	1" x 1"1/4	20/80	
131212002	1"1/4 x 1"1/2	50	
131215002	1"1/2 x 2"	70	
131220002	2" x 2"1/2	30	

IVR 312 P/N RACCORDO SEDE PIANA NICHELATO

NEW



EAC

Raccordo diritto in due pezzi a sede piana con guarnizione, nichelato
Nickel-plated 2-piece straight union end with flat seat with gasket
Vernickeltes zweiteiliges Anschlussstück mit gerader Verschraubung und flachem Sitz mit Dichtung
Raccord droit nickelé en deux pièces à siège plate avec joint
Никелированный двухсоставной прямой соединительный фитинг с плоским седлом и уплотнением

Cod./Code	DN	□/田	€
131205001	1/2" x 3/4"	50/200	
131207001	3/4" x 1"	50/200	
131210001	1" x 1"1/4	20/80	
131212001	1"1/4 x 1"1/2	50	
131215001	1"1/2 x 2"	70	
131220001	2" x 2"1/2	30	

IVR 310 P RACCORDO SEDE PIANA



EAC

Raccordo diritto in tre pezzi a sede piana con guarnizione
3 pieces union end with gasket
Anschlussstück mit gerader Verschraubung, dreiteilig, mit Flachsitz und Dichtung
Raccord droit en trois pièces à siège plat avec joint
Трёхсоставной прямой соединительный фитинг с плоским седлом и уплотнением

Cod./Code	DN	□/田	€
131003001	3/8"	20/120	
131005001	1/2"	20/120	
131007001	3/4"	20/80	
131010001	1"	20/80	
131012001	1"1/4	10/40	
131015001	1"1/2	50	
131020001	2"	25	

IVR 310 P/N RACCORDO SEDE PIANA NICHELATO

NEW



EAC

Raccordo diritto in tre pezzi a sede piana con guarnizione, nichelato
Nickel-plated 3-piece straight union end with flat seat with gasket
Vernickeltes dreiteiliges Anschlussstück mit gerader Verschraubung und flachem Sitz mit Dichtung
Raccord droit nickelé en trois pièces à siège plate avec joint
Никелированный трёхсоставной прямой соединительный фитинг с плоским седлом и уплотнением

Cod./Code	DN	□/⊞	€
131003002	3/8"	20/120	
131005002	1/2"	20/120	
131007002	3/4"	20/80	
131010002	1"	20/80	
131012002	1"1/4	10/40	
131015002	1"1/2	50	
131020002	2"	25	

IVR 315 P RACCORDO SEDE PIANA



EAC

Raccordo curvo in tre pezzi a sede piana con guarnizione
90-degree 3 pieces union end with gasket
Anschlussstück mit gebogener Verschraubung, dreiteilig, mit Flachsitz und Dichtung
Raccord courbe en trois pièces à siège plat avec joint
Трёхсоставной угловой соединительный фитинг с плоским седлом и уплотнением

Cod./Code	DN	□/⊞	€
131503001	3/8"	200	
131505001	1/2"	200	
131507001	3/4"	100	
131510001	1"	50	
131512001	1"1/4	50	
131515001	1"1/2	25	
131520001	2"	15	

IVR 315 P/N RACCORDO SEDE PIANA NICHELATO

NEW



EAC

Raccordo curvo in tre pezzi a sede piana con guarnizione, nichelato
Nickel-plated 3-piece straight union end with flat seat with gasket
Vernickeltes dreiteiliges Anschlussstück mit Eckverschraubung und flachem Sitz mit Dichtung
Raccord équerre nickelé en trois pièces à siège plate avec joint
Никелированный трёхсоставной угловой соединительный фитинг с плоским седлом и уплотнением

Cod./Code	DN	□/⊞	€
131503002	3/8"	200	
131505002	1/2"	200	
131507002	3/4"	100	
131510002	1"	50	
131512002	1"1/4	50	
131515002	1"1/2	25	
131520002	2"	15	

IVR 310 C RACCORDO SEDE CONICA



Raccordo diritto in tre pezzi a sede conica con o-ring

3 pieces union end conical seat with o-ring

Anschlussstück mit gerader Verschraubung, dreiteilig, mit Kegelsitz und O-Ring

Raccord droit en trois pièces à siège conique avec o-ring

Трёхсоставной прямой соединительный фитинг с коническим седлом и уплотняющим О-кольцом

Cod./Code	DN	□/田	€
131003010	3/8"	100	
131005010	1/2"	50/200	
131007010	3/4"	25/100	
131010010	1"	20/80	
131012010	1"1/4	10/40	
131015010	1"1/2	50	
131020010	2"	25	

EAC

IVR 310 C/N RACCORDO SEDE CONICA NICHELATO

NEW



Raccordo diritto in tre pezzi a sede conica con o-ring, nichelato

Nickel-plated 3-piece straight union end with conical seat and O-ring

Vernickeltes dreiteiliges Anschlussstück mit gerader Verschraubung und Kegelsitz mit O-Ring

Raccord droit nickelé en trois pièces à siège conique avec joint

Никелированный трёхсоставной прямой соединительный фитинг с коническим седлом и уплотняющим О-кольцом

Cod./Code	DN	□/田	€
131003012	3/8"	100	
131005012	1/2"	50/200	
131007012	3/4"	25/100	
131010012	1"	20/80	
131012012	1"1/4	10/40	
131015012	1"1/2	50	
131020012	2"	25	

EAC

IVR 315 C RACCORDO SEDE CONICA



Raccordo curvo in tre pezzi a sede conica con o-ring

90-degree 3 pieces union end conical seat with o-ring

Anschlussstück mit gebogener Verschraubung, dreiteilig, mit Kegelsitz und O-Ring

Raccord courbe en trois pièces à siège conique avec o-ring

Трёхсоставной угловой соединительный фитинг с коническим седлом и уплотняющим О-кольцом

Cod./Code	DN	□/田	€
131503010	3/8"	200	
131505010	1/2"	200	
131507010	3/4"	100	
131510010	1"	75	
131512010	1"1/4	50	
131515010	1"1/2	25	
131520010	2"	15	

EAC

IVR 315 C/N RACCORDO SEDE CONICA NICHELATO

NEW



Raccordo curvo in tre pezzi a sede conica con o-ring, nichelato
Nickel-plated 90-degree 3-piece straight union end with conical seat and O-ring
Vernickeltes dreiteiliges Anschlussstück mit Eckverschraubung und Kugelsitz mit O-Ring
Raccord équerre nickelé en trois pièces à siège conique avec o-ring
Никелированный трёхсоставной угловой соединительный фитинг с коническим седлом и уплотняющим O-кольцом

Cod./Code	DN	□/田	€
131503012	3/8"	200	
131505012	1/2"	200	
131507012	3/4"	100	
131510012	1"	75	
131512012	1"1/4	50	
131515012	1"1/2	25	
131520012	2"	15	

EAC

IVR 318 RACCORDO PER CONTATORI ACQUA



Coppia di raccordi per contatori acqua completi di guarnizioni
Couple of union connections for water meters fitted with washers
Zwei Anschlüsse für Wasserzähler mit Dichtungen
Couple de raccords pour compteurs d'eau
Пара фитингов для счетчиков воды в комплекте с прокладками

Cod./Code	DN	□/田	€
131805001	1/2" x 3/4"	120	
131807001	3/4" x 1"	100	
131810001	1" x 1"1/4	75	
131812001	1"1/4 x 1"1/2	50	
131815001	1"1/2 x 2"	25	
131820001	2" x 2"1/2	15	

EAC

IVR 320 RACCORDO



Raccordo a cinque vie tipo corto
Five ways short connection
5-Wege-Anschlussstück, kurze Ausführung
Raccord à cinq voies type court
Укороченный соединительный фитинг на пять выходов

Cod./Code	DN	H	□/田	€
132010001	1"	72	100	

EAC

IVR 321 RACCORDO



Raccordo a cinque vie tipo lungo
Five ways long connection
5-Wege-Anschlussstück, lange Ausführung
Raccord à cinq voies type long
Удлиненный соединительный фитинг на пять выходов

Cod./Code	DN	H	□/田	€
132110001	1"	95	100	

EAC



IVR 42/43 R QUADRO DI MANOVRA



Quadro manovra 28 mm per IVR 42- 43
Square cap 28 mm for IVR 42 - 43
Schalttafel 28 mm für IVR 42- 43
Tableau de manoeuvre 28 mm pour IVR 42 - 43
Квадратный хвостовик 28 мм для IVR 42 - 43

Cod./Code	Misura/Size	DN	□/田	€
705010001	1a MIS	1/2" - 3/4"	10	
705020001	2a MIS	1" - 1"1/4"	10	
705030001	3a MIS	1"1/2 - 2"	10	

IVR 966 R GIRELLO PER IDRETTO



Girello completo per Idretto IVR 966
Hose union for bibcock for Idretto IVR 966
Schlauchanschluss für Idretto IVR 966
Jonction pour Idretto IVR 966
Насадка для подключения шланга - для IDRETTO IVR 966

Cod./Code	Misura/Size	□/田	€
338003150	3/8"	1	
338005150	1/2"	1	
338007150	3/4"	1	
338010150	1"	1	

IVR 130 R PROLUNGA E SET RICAMBI



Prolunga e set ricambi parti cromate per valvole incasso
Stem extensions and set of chrome-plated spare parts for ball valves for in-wall installations
Verlängerung und Ersatzteileset für verchromte Unterputzventilteile
Rallonge et kit de pièces de rechange chromées pour vannes à encastrer
Насадка удлиняющая и набор хромированных запасных частей для встраиваемых клапанов

Cod./Code	Misura/Size	Per articoli/For items/Für Artikel/pour article /Для изделия	□/田	€
109799001	1/2"-3/4"-1"	Prolunga / Stem - 130-134-135	1	



Cod./Code	Misura/Size	Per articoli/For items/Für Artikel/pour article /Для изделия	□/田	€
911300501	1/2"	130	1	
911300701	3/4"	130	1	
911301001	1"	130	1	



Cod./Code	Misura/Size	Per articoli/For items/Für Artikel/pour article /Для изделия	□/田	€
911340501	1/2"	134	1	
911340701	3/4"	134	1	
911341001	1"	134	1	



Cod./Code	Misura/Size	Per articoli/For items/Für Artikel/pour article /Для изделия	□/田	€
911350501	1/2"	135	1	
911350701	3/4"	135	1	
911351001	1"	135	1	

IVR 359 MANOMETRO



Manometro Ø 50 - 63 mm - attacco posteriore per IVR 300 - 303 - 305
Axial pressure gauge Ø 50 - 63 mm - back connection for IVR 300 - 303 - 305
Manometer Ø 50 - 63 mm - Anschluss hinten, für IVR 300 - 303 - 305
Manomètre Ø 50 - 63 mm - fixation arrière pour IVR 300 - 303 - 305
Манометр с осевым подключением Ø 50 - 63 мм - для IVR 300 - 303 - 305

Cod./Code	DN	Ø	□/田	€
135902116	1/4"	Ø 50 - scale 0-16 bar	100	
135902206	1/4"	Ø 63 - scale 0-6 bar	100	
135902210	1/4"	Ø 63 - scale 0-10 bar	100	
135902216	1/4"	Ø 63 - scale 0-16 bar	100	

IVR 358 MANOMETRO RADIALE ALIMENTAZIONE



Manometro diametro 50 - 63 mm - attacco radiale - per IVR 304
Radial pressure gauge circle 50 - 63 mm - for IVR 304
Manometer Ø 50 - 63 mm - Anschluss unten, für IVR 304
Manomètre Ø 50 - 63mm - fixation radiale pour ivr 304
Радиальный манометр 50-63 мм для IVR 304

Cod./Code	DN	Ø	□/田	€
135802116	1/4"	Ø 50 - scala/scale 0-16 bar	1/100	
135802206	1/4"	Ø 63 - scala/scale 0-6 bar	1/100	
135802210	1/4"	Ø 63 - scala/scale 0-10 bar	1/100	
135802216	1/4"	Ø 63 - scala/scale 0-16 bar	1/100	

IVR 924 C



Cod./Code	DN	□/田	€
334105001	1/2"	1	
334107001	3/4"	1	
334110001	1"	1	
334112001	1" 1/4	1	
334115001	1" 1/2	1	
334120001	2"	1	
334125001	2" 1/2	1	
334130001	3"	1	
334140001	4"	1	



FILTRO AUTOPULENTE - SELF-CLEANING FILTER

IVR 398

NEW



Filtro autopulente F/F
Self-cleaning filter F/F
Selbstreinigender Filter IG/IG
Filtre autonettoyant F/F
Самоочищающийся фильтр В/В

Cod./Code	DN	□/田	€
139805001	1/2"	1	
139807001	3/4"	1	
139810001	1"	1	
139812001	1" 1/4	1	
139815001	1" 1/2	1	
139820001	2"	1	

Per manometri vedi pagina 215
For pressure gauges see page 215

IVR 399

NEW



Filtro autopulente F/F con manometri
Self-cleaning filter F/F with pressure gauges
Selbstreinigender Filter IG/IG mit Manometern
Filtre autonettoyant F/F avec manomètres
Самоочищающийся фильтр В/В с манометрами

Cod./Code	DN	□/田	€
139905001	1/2"	1	
139907001	3/4"	1	
139910001	1"	1	
139912001	1" 1/4	1	
139915001	1" 1/2	1	
139920001	2"	1	

Per manometri vedi pagina 215
For pressure gauges see page 215