

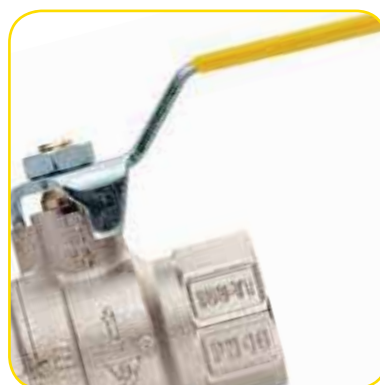

VALVOLE GAS
GAS VALVES
GASKUGELHÄHNE
VANNES GAZ
ЗАПОРНАЯ АРМАТУРА ДЛЯ ГАЗА





Valvole in ottone per gas
Brass Gas valves

DIN	p. 219
Elite	p. 221
Elite ISO 7-1 RC	p. 224
Export ISO 7-1 RC	p. 227
Evergas	p. 229
Valvola a sfera con raccordo per presa pressione - Ball valve for gas with pressure gauge	p. 231



Valvola a sfera per gas in ghisa attacchi flangiati PN16
Cast iron ball valve for gas - flanged ends PN16

IVR 82	p. 236
IVR 83	p. 237



Valvola a farfalla in ghisa per gas
Cast iron butterfly valve for gas

IVR 177	p. 238
IVR 277 CF8M	p. 238
IVR 178	p. 238
IVR 278 CF8M	p. 239



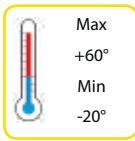

IVR DIN

IVR 100 DIN 100 DIN



Valvola a sfera per gas a passaggio totale omologata DVGW e HTB - attacchi F/F (DIN3357-4)
Full bore ball valve for gas approved by DVGW and HTB - threaded ends F/F (DIN3357-4)
Gas-Kugelhahn mit vollem Durchgang - DVGW- und HTB-Zulassung IG/IG (DIN3357-4)
Vanne à boisseau sphérique à passage intégral certifiée DVGW et HTB - fixations F/F (DIN3357-4)
Полнопроходной шаровой кран для газа (одобрено DVGW и HTB) - соединения В/В (DIN3357-4)

Cod./Code	DN	Ø	□/田	€
105003007	3/8"	10	10/120	
105005007	1/2"	15	5/60	
105007007	3/4"	20	15/60	
105010007	1"	25	10/40	
105012007	1"1/4	32	4/16	
105015007	1"1/2	40	4/16	
105020007	2"	50	2/8	



IVR 100/A DIN 100 DIN





Valvola a sfera per gas a passaggio totale omologata DVGW e HTB - attacchi F/F (DIN3357-4)
Full bore ball valve for gas HTB - threaded ends F/F (DIN3357-4)
Gas-Kugelhahn mit vollem Durchgang - DVGW- und HTB-Zulassung IG/IG (DIN3357-4)
Vanne à boisseau sphérique à passage intégral certifiée HTB - fixations F/F (DIN3357-4)
Полнопроходной шаровой кран для газа (одобрено DVGW и HTB) - соединения В/В (DIN3357-4)

Cod./Code	DN	Ø	□/田	€
105003002	3/8"	10	10/120	
105005002	1/2"	15	5/60	
105007002	3/4"	20	15/60	
105010002	1"	25	10/40	

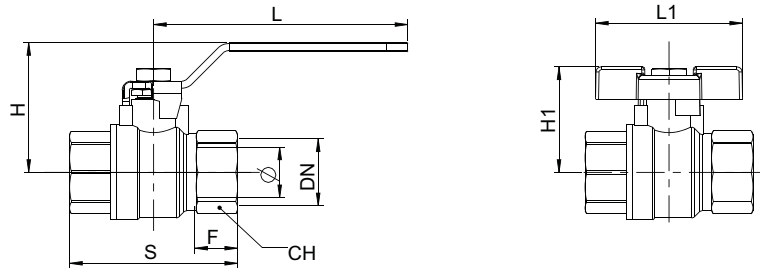



100 DIN		DIMENSIONI / DIMENSIONS													
DN	Ø	S	S1	S2	L	L1	L2	L4	H	H1	H2	H4	F	F1	CH
3/8"	10	60			80	50			40	33			19		22
1/2"	15	75			90	61			52	39			23		26
3/4"	20	80			90	61			55	43			23,5		31
1"	25	90			125	72			64	52			24,5		40
1"1/4	32	110			125				69				31		49
1"1/2	40	120			140				78				32		55
2"	50	141			140				85				36		68

100 DIN		ACCESSORI / RICAMBI - ACCESSORIES / SPARE PARTS						
	3/8"	1/2"	3/4"	1"	1"1/4	1"1/2	2"	
	700103501	700113501	700113501	700123501	700123501	700133501	700133501	
	703003501	703013501	703013501	703023501				
	750106001	750108001	750108001	750110001	750110001	750114001	750114001	



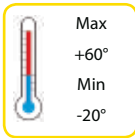

IVR ELITE

IVR 100 ELITE EN 331 - HTB EN 1775



Valvola a sfera per gas a passaggio totale HTB - attacchi F/F
Full bore ball valve for gas HTB - threaded ends F/F
Gas-Kugelhahn mit vollem Durchgang HTB - IG/IG
Vanne à boisseau sphérique à passage intégral certifiée HTB - fixations F/F
Полнопроходной шаровой кран для газа HTB - соединения В/В



(*) Non omologata
(*) Not certified
(*) Ohne Zulassung
(*) Pas certifiée
(*) Без сертификата

Cod./Code	DN	Ø	□/田	€
110002013	1/4"	10	10/120	
110003013	3/8"	10	10/120	
110005013	1/2"	15	12/72	
110007013	3/4"	20	20/80	
110010013	1"	25	12/48	
110012013	1"1/4	32	6/24	
110015013	1"1/2	40	4/16	
110020013	2"	50	4/16	
110025013	2"1/2	61	8	(*)
110030013	3"	74	6	(*)
110040013	4"	95	2	(*)

IVR 100/A ELITE EN 331 - HTB EN 1775



Valvola a sfera per gas a passaggio totale HTB - attacchi F/F
Full bore ball valve for gas HTB - threaded ends F/F
Gas-Kugelhahn mit vollem Durchgang HTB - IG/IG
Vanne à boisseau sphérique à passage intégral certifiée HTB - fixations F/F
Полнопроходной шаровой кран для газа HTB - соединения В/В



Cod./Code	DN	Ø	□/田	€
110002001	1/4"	10	10/120	
110003001	3/8"	10	10/120	
110005001	1/2"	15	12/72	
110007001	3/4"	20	20/80	
110010001	1"	25	12/48	

IVR 101 ELITE EN 331 - HTB EN 1775



Valvola a sfera per gas a passaggio totale HTB - attacchi M/F
Full bore ball valve for gas HTB - threaded ends M/F
Gas-Kugelhahn mit vollem Durchgang - HTB-Zulassung - AG/IG
Vanne à boisseau sphérique à passage intégral certifiée HTB - fixations M/F
Полнопроходной шаровой кран для газа HTB - соединения Н/В



Cod./Code	DN	Ø	□/田	€
110103013	3/8"	10	10/120	
110105013	1/2"	15	12/72	
110107013	3/4"	20	15/60	
110110013	1"	25	12/48	
110112013	1"1/4	32	6/24	
110115013	1"1/2	40	4/16	
110120013	2"	50	4/16	



IVR 101/A ELITE EN 331 - HTB EN 1775



Valvola a sfera per gas a passaggio totale HTB - attacchi M/F
 Full bore ball valve for gas HTB - threaded ends M/F
 Gas-Kugelhahn mit vollem Durchgang - HTB-Zulassung - AG/IG
 Vanne à boisseau sphérique à passage intégral certifiée HTB - fixations M/F
 Полнопроходной шаровой кран для газа HTB - соединения Н/В



Cod./Code	DN	Ø	□/田	€
110103001	3/8"	10	10/120	
110105001	1/2"	15	12/72	
110107001	3/4"	20	15/60	
110110001	1"	25	12/48	

IVR 100 LD ELITE EN 331 - HTB EN 1775



Valvola a sfera a passaggio totale omologata HTB - attacchi F/F - con maniglia lucchettabile
 Full bore ball valve for gas HTB - threaded ends F/F - with lockable handle
 Gas-Kugelhahn mit vollem Durchgang Zulassung nach HTB IG/IG - mit verriegelbarem Hebel
 Vanne à boisseau sphérique à passage intégral certifiée HTB Fixations F/F - avec poignée cadenassable
 Полнопроходной шаровой кран для газа - одобрено HTB - соединения В/В - с запираемой рукояткой



Cod./Code	DN	Ø	□/田	€
110002762	1/4"	10	10/120	
110003762	3/8"	10	10/120	
110005762	1/2"	15	12/72	
110007762	3/4"	20	20/80	
110010762	1"	25	12/48	
110012762	1"1/4	32	6/24	
110015762	1"1/2	40	4/16	
110020762	2"	50	4/16	

IVR 101 LD ELITE EN 331 - HTB EN 1775



Valvola a sfera a passaggio totale omologata HTB - attacchi M/F Con maniglia lucchettabile
 Full bore ball valve for gas HTB - threaded ends M/F - with lockable handle
 Kugelhahn mit vollem Durchgang Zulassung nach HTB AG/IG - mit verplombbarer Hebel
 Vanne à boisseau sphérique à passage intégral certifiée HTB Fixations M/F - avec poignée cadenassable
 Полнопроходной шаровой кран для газа - одобрено HTB - соединения Н/В - с запираемой рукояткой



Cod./Code	DN	Ø	□/田	€
110103762	3/8"	10	10/120	
110105762	1/2"	15	12/72	
110107762	3/4"	20	20/80	
110110762	1"	25	12/48	
110112762	1"1/4	32	6/24	
110115762	1"1/2	40	4/16	
110120762	2"	50	4/16	

IVR 182 ELITE GAS EN 331



Valvola a sfera a passaggio totale per gas con cappuccio piombabile - attacchi F/F
Full bore ball valve for gas with seal cap - threaded ends F/F
Gas-Kugelhahn mit vollem Durchgang mit verplombbarer Kappe IG/IG
Vanne à boisseau sphérique à passage intégral pour gaz avec capuchon plombable fixations F/F
Полнопроходной шаровой кран для газа с колпачком для пломбирования, соединения В/В

Cod./Code	DN	Ø	□/田	€
118205001	1/2"	15	10/60	
118207001	3/4"	20	10/40	
118210001	1"	25	10/40	
118212001	1"1/4	32	6/24	
118215001	1"1/2	40	5/20	
118220001	2"	50	2/8	

EAC

IVR 183 ELITE GAS EN 331



Valvola a sfera a passaggio totale per gas con cappuccio piombabile - attacchi M/F -
Full bore gas valve with sealing cap - threaded ends M/F
Gaskugelhahn mit vollem Durchgang mit verplombbarer Kappe - AG/IG
Vanne à boisseau sphérique pour gaz à passage intégral avec capuchon plombable fixations M/F
Полнопроходной шаровой кран для газа с колпачком для пломбирования - соединения Н/В

Cod./Code	DN	Ø	□/田	€
118305001	1/2"	15	10/60	
118307001	3/4"	20	10/40	
118310001	1"	25	10/40	
118312001	1"1/4	32	6/24	
118315001	1"1/2	40	5/20	
118320001	2"	50	2/8	

EAC

IVR 192 ELITE HTB



Valvola a sfera per gas a passaggio totale, con codolo - HTB. Attacchi filettati F/F
Full bore ball valve for gas with tang - HTB. F/F threaded ends
Gas-Kugelhahn mit vollem Durchgang HTB - IG/IG
Vanne a sphere pour gaz à passage intégrale avec queue - HTB. Taraudage F/F
Полнопроходной шаровой кран для газа с хвостовиком - HTB. Резьба: В/В

Cod./Code	DN	Ø	□/田	€
119205007	1/2" ELI FF HTB C/COD MP GIA	15	12/72	
119207007	3/4" ELI FF HTB C/COD MP GIA	20	15/60	
119210007	1" ELI FF HTB C/COD MP GIA	25	12/48	



IVR ELITE ISO 7-1 RC

MOP 5-20

Max
+60°
Min
-20°

UNI EN 10226-2
(ISO 7-1 Rc)

IVR 190 ELITE HTB (ISO 7-1 RC)



Valvola a sfera per gas a passaggio totale HTB - attacchi F/F
Full bore ball valve for gas HTB - threaded ends F/F
Gas-Kugelhahn mit vollem Durchgang HTB - IG/IG
Vanne à boisseau sphérique pour gaz à passage intégral HTB - fixations F/F
Полнопроходной шаровой кран для газа HTB - соединения В/В

Cod./Code	DN	Ø	□/田	€
119002001	1/4"	10	10/120	
119003001	3/8"	10	10/120	
119005001	1/2"	15	12/72	
119007001	3/4"	20	20/80	
119010001	1"	25	12/48	
119012001	1"1/4	32	6/24	
119015001	1"1/2	40	4/16	
119020001	2"	50	4/16	



IVR 190/A ELITE HTB (ISO 7-1 RC)



Valvola a sfera per gas a passaggio totale HTB - attacchi F/F
Full bore ball valve for gas HTB - threaded ends F/F
Gas-Kugelhahn mit vollem Durchgang HTB - IG/IG
Vanne à boisseau sphérique pour gaz à passage intégral HTB - fixations F/F
Полнопроходной шаровой кран для газа HTB - соединения В/В

Cod./Code	DN	Ø	□/田	€
119002002	1/4"	10	10/120	
119003002	3/8"	10	10/120	
119005002	1/2"	15	12/72	
119007002	3/4"	20	20/80	
119010002	1"	25	12/48	
119012002	1"1/4	32	6/24	



IVR 191 ELITE HTB (ISO 7-1 RC)



Valvola a sfera per gas a passaggio totale HTB - attacchi M/F
Full bore ball valve for gas HTB - threaded ends M/F
Gas-Kugelhahn mit vollem Durchgang HTB - AG/IG
Vanne à boisseau sphérique pour gaz à passage intégral HTB - fixations M/F
Полнопроходной шаровой кран для газа HTB - соединения Н/В

Cod./Code	DN	Ø	□/田	€
119103001	3/8"	10	10/120	
119105001	1/2"	15	12/72	
119107001	3/4"	20	15/60	
119110001	1"	25	12/48	
119112001	1"1/4	32	6/24	
119115001	1"1/2	40	4/16	
119120001	2"	50	4/16	



IVR 191/A ELITE HTB (ISO 7-1 RC)



Valvola a sfera per gas a passaggio totale HTB - attacchi M/F
Full bore ball valve for gas HTB - threaded ends M/F
Gas-Kugelhahn mit vollem Durchgang HTB - AG/IG
Vanne à boisseau sphérique pour gaz à passage intégral HTB - fixations M/F
Полнопроходной шаровой кран для газа HTB - соединения Н/В

Cod./Code	DN	Ø	□/田	€
119103002	3/8"	10	10/120	
119105002	1/2"	15	12/72	
119107002	3/4"	20	15/60	
119110002	1"	25	12/48	
119112002	1"1/4	32	6/24	



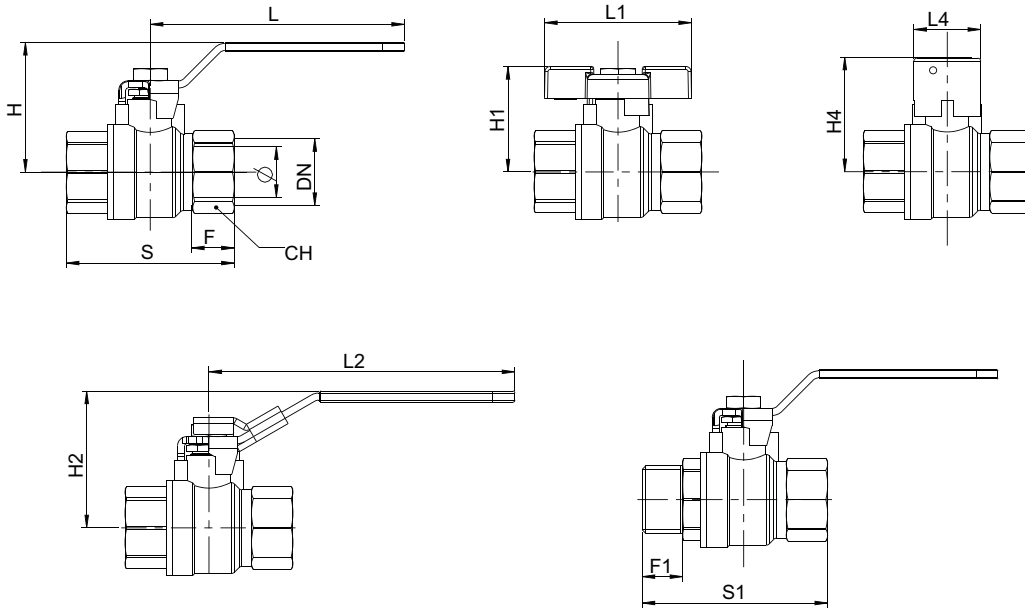

ELITE															
DIMENSIONI / DIMENSIONS															
DN	Ø	S	S1	S2	L	L1	L2	L4	H	H1	H2	H4	F	F1	CH
1/4"	10	45	42		80	50	95		41	33	43		12	10	21
3/8"	10	45	54		80	50	95		41	33	43		12	12	21
1/2"	15	63	70		90	61	120	29	52	39	56	45	17	15	26
3/4"	20	71	80		90	61	120	29	55	43	60	49	19,5	16	31
1"	25	83	92		125	72	150	33	65		68	56	21	19	38
1 1/4"	32	92	102		125		150	33	69		73	61	22	20,5	48
1 1/2"	40	104	117		140		160	44	78		87	75	23,5	21,5	55
2"	50	124	137		140		160	44	85		94	82	28	24,5	68
2 1/2"	60	140			250				131				28		85
3"	74	159			250				140				30,5		99
4"	94	196			250				156				38		125

ELITE											
ACCESSORI / RICAMBI - ACCESSORIES / SPARE PARTS											
	1/4"	3/8"	1/2"	3/4"	1"	1 1/4"	1 1/2"	2"	2 1/2"	3"	4"
	700103501	700103501	700113501	700113501	700123501	700123501	700133501	700133501	700443501	700443501	700153501
	703003501	703003501	703013501	703013501	703023501	703023501					
	125703907	125703907	125705907	125705907	125710907	125710907	125715907	125715907			
	750106001	750106001	750108001	750108001	750110001	750110001	750114001	750114001	750116001	750116001	
			706013501	706013501	706023501	706023501	706033501	706033501			

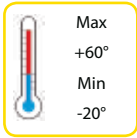

IVR EXPORT ISO 7-1 RC

IVR 45 GAS EXPORT EN 331 (ISO 7-1 RC)



Valvola a sfera a passaggio totale - attacchi F/F
Full bore gas valve - threaded ends F/F
Gas-Kugelhahn mit vollem Durchgang - IG/IG
Vanne à boisseau sphérique à passage intégral - fixations F/F
Полнопроходной шаровой кран для газа - соединения В/В

Cod./Code	DN	Ø	□/田	€
104502008	1/4"	10	10/120	
104503008	3/8"	10	10/120	
104505008	1/2"	15	12/72	
104507008	3/4"	20	20/80	
104510008	1"	25	12/48	
104512008	1"1/4	32	6/24	
104515008	1"1/2	40	4/16	
104520008	2"	50	4/12	



IVR 45/A GAS EXPORT EN 331 (ISO 7-1 RC)



Valvola a sfera a passaggio totale - attacchi F/F
Full bore gas valve - threaded ends F/F
Gas-Kugelhahn mit vollem Durchgang - IG/IG
Vanne à boisseau sphérique à passage intégral - fixations F/F
Полнопроходной шаровой кран для газа - соединения В/В

Cod./Code	DN	Ø	□/田	€
104502005	1/4"	10	10/120	
104503005	3/8"	10	10/120	
104505005	1/2"	15	12/72	
104507005	3/4"	20	20/80	
104510005	1"	25	12/48	



IVR 45 LD GAS EXPORT EN 331 LD (ISO 7-1 RC)



Valvola a sfera a passaggio totale - attacchi F/F - con maniglia lucchettabile
Full bore gas valve - threaded ends F/F - with lockable handle
Gas-Kugelhahn mit vollem Durchgang - IG/IG - mit verriegelbarem Hebel
Vanne à boisseau sphérique à passage intégral - fixations F/F - avec poignée cadénassable
Полнопроходной шаровой кран для газа - соединения В/В - с запираемой рукояткой

Cod./Code	DN	Ø	□/田	€
104502757	1/4"	10	10/120	
104503757	3/8"	10	10/120	
104505757	1/2"	15	12/72	
104507757	3/4"	20	20/80	
104510757	1"	25	10/40	
104512757	1"1/4	32	6/24	
104515757	1"1/2	40	4/16	
104520757	2"	50	4/16	



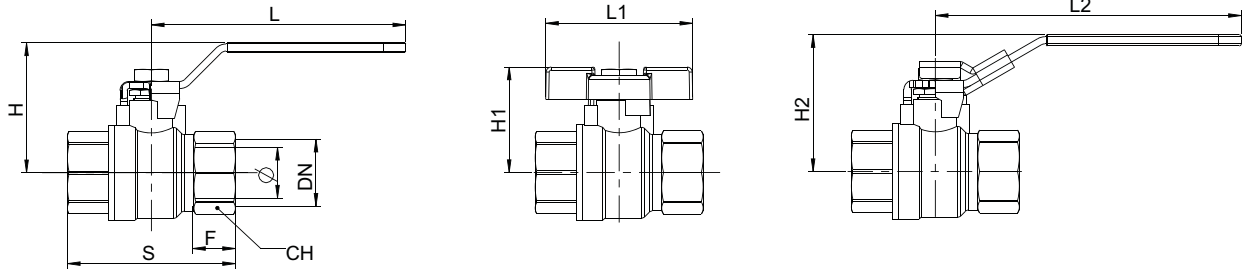

EXPORT ISO 7-1 RC		DIMENSIONI / DIMENSIONS													
DN	Ø	S	S1	S2	L	L1	L2	L5	H	H1	H2	H5	F	F1	CH
1/4"	10	45			80	50	95		41	33	43		12		21
3/8"	10	45			80	50	95		41	33	43		12		21
1/2"	15	63			90	61	120		52	39	56		17		26
3/4"	20	71			90	61	120		55	43	60		19,5		31
1"	25	83			125	72	150		65		68		21		38
1 1/4"	32	92			125		150		69		73		22		48
1 1/2"	40	104			140		160		78		87		23,5		55
2"	50	124			140		160		85		94		28		68
2 1/2"	60	140			250				131				28		85
3"	74	159			250				140				30,5		99
4"	94	196			250				156				38		125

EXPORT ISO 7-1 RC		ACCESSORI / RICAMBI - ACCESSORIES / SPARE PARTS										
	1/4"	3/8"	1/2"	3/4"	1"	1 1/4"	1 1/2"	2"	2 1/2"	3"	4"	
	700103001	700103001	700113001	700113001	700123001	700123001	700133001	700133001	700153001	700153001	700153001	
	703003201	703003201	703013201	703013201	703023201							
	125703907	125703907	125705907	125705907	125710907	125710907	125715907	125715907				
	750106001	750106001	750108001	750108001	750110001	750110001	750114001	750114001	750118001	750118001	750118001	

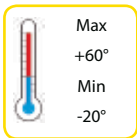

IVR EVERGAS

IVR 151 EVERGAS EN 331



Valvola a sfera per gas a passaggio standard - attacchi F/F
Standard bore ball valve for gas - threaded ends F/F
Gas-Kugelhahn mit normalem Durchgang - IG/IG
Vanne à boisseau sphérique pour gaz à passage normal - fixations F/F
Шаровой кран для газа со стандартным проходом - соединения В/В

Cod./Code	DN	Ø	□/田	€
115105007	1/2"	14	12/72	
115107007	3/4"	18	20/80	
115110007	1"	23	12/48	
115112007	1"1/4	29	8/32	
115115007	1"1/2	37	4/16	
115120007	2"	47	4/16	



IVR 151/A EVERGAS EN 331



Valvola a sfera per gas a passaggio standard - attacchi F/F
Standard bore ball valve for gas - threaded ends F/F
Gas-Kugelhahn mit normalem Durchgang - IG/IG
Vanne à boisseau sphérique pour gaz à passage normal - fixations F/F
Шаровой кран для газа со стандартным проходом - соединения В/В

Cod./Code	DN	Ø	□/田	€
115105008	1/2"	14	12/144	
115107008	3/4"	18	20/80	
115110008	1"	23	12/48	



IVR 152 EVERGAS EN 331



Valvola a sfera per gas a passaggio standard - attacchi M/F
Standard bore ball valve for gas - threaded ends M/F
Gas-Kugelhahn mit normalem Durchgang - AG/IG
Vanne à boisseau sphérique pour gaz à passage normal - fixations M/F
Шаровой кран для газа со стандартным проходом - соединения Н/В

Cod./Code	DN	Ø	□/田	€
115205007	1/2"	14	12/72	
115207007	3/4"	18	20/80	
115210007	1"	23	12/48	
115212007	1"1/4	29	6/24	
115215007	1"1/2	37	4/16	
115220007	2"	47	4/16	



IVR 152/A EVERGAS EN 331



Valvola a sfera per gas a passaggio standard - attacchi M/F
 Standard bore ball valve for gas - threaded ends M/F
 Gas-Kugelhahn mit normalem Durchgang - AG/IG
 Vanne à boisseau sphérique pour gaz à passage normal - fixations M/F
 Шаровой кран для газа со стандартным проходом - соединения Н/В

Cod./Code	DN	Ø	□/田	€
115205008	1/2"	14	12/72	
115207008	3/4"	18	20/80	
115210008	1"	23	12/48	

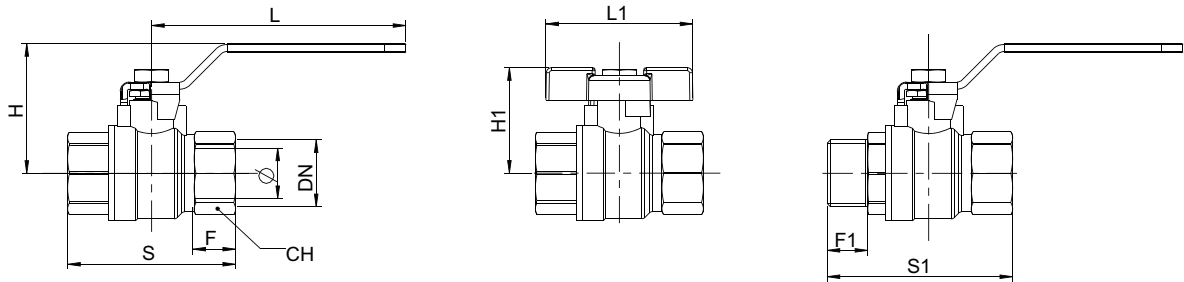

EVERGAS

DIMENSIONI / DIMENSIONS

DN	Ø	S	S1	S2	L	L1	L2	L3	H	H1	H2	H3	F	F1	CH
1/2"	14	55	63,5		92	50			42,5	36			15	15	25
3/4"	18	61,5	69		92	50			45	39			16	16	31
1"	23	73	81,5		115	61			60	45			18	18	38
1"1/4	29	85,5	94,5		115				64				20,5	20,5	47
1"1/2	37	97	106		150				74,5				20,5	20,5	54
2"	47	117	129		150				81,5				25,5	25	66

EVERGAS

ACCESSORI / RICAMBI - ACCESSORIES / SPARE PARTS

	1/2"	3/4"	1"	1"1/4	1"1/2	2"
	700413501	700413501	700423501	700423501	700433501	700433501
	703003501	703003501	703013501	703013501		
	125703907	125703907	125705907	125705907	125710907	125710907
	750106001	750106001	750108001	750108001	750110001	750110001

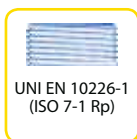
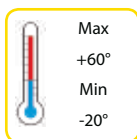
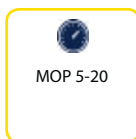

IVR PRESA PRESSIONE

IVR 212 CONFORME EN 331



Valvola a sfera con raccordo per presa pressione
Full bore ball valve for gas with pressure gauge
Kugelhahn mit Anschluss für Druckanschluss
Vanne à boisseau sphérique avec raccord pour prise pression
Полнопроходной шаровой кран для газа с соединением для точки отбора



Cod./Code	DN	Ø	□/田	€
121205007	1/2"	15	10/60	
121207007	3/4"	20	20/80	
121210007	1"	25	12/48	

IVR 212/A CONFORME EN 331



Valvola a sfera con raccordo per presa pressione
Full bore ball valve for gas with pressure gauge
Kugelhahn mit Anschluss für Druckanschluss
Vanne à boisseau sphérique avec raccord pour prise pression
Полнопроходной шаровой кран для газа с соединением для точки отбора



Cod./Code	DN	Ø	□/田	€
121205008	1/2"	15	10/60	
121207008	3/4"	20	20/80	
121210008	1"	25	12/48	

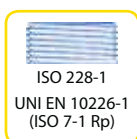
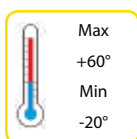

IVR RUBINETTI

IVR 110 UNI CIG



Rubinetto a sfera a squadra per gas EN 14800:2007 - attacchi F/F
Angle ball valve with spread for gas with fastening for flexible metallic pipe EN 14800:2007 - threaded ends F/F
Gas-Kugelhahn, eckförmig EN 14800:2007 - IG/IG
Robinet à boisseau sphérique à équerre pour gaz EN 14800:2007 - fixations F/F
Угловой шаровой кран для газа EN 14800:2007 - соединения В/В



Cod./Code	DN	Ø	□/田	€
111005010	1/2" x 1/2"	12,5	10/120	



IVR 111 UNI CIG



Rubinetto a sfera a squadra per gas EN 14800:2007 - attacchi M/F
Angle ball valve with spread for gas with fastening for flexible metallic pipe EN 14800:2007 - threaded ends M/F
Gas-Kugelhahn, eckförmig EN 14800:2007 - AG/IG
Robinet à boisseau sphérique à équerre pour gaz EN 14800:2007 - fixations M/F
Угловой шаровой кран для газа EN 14800:2007 - соединения Н/В



Cod./Code	DN	Ø	□/田	€
111105010	1/2" x 1/2"	12,5	10/120	

IVR 112 UNI CIG



Rubinetto a sfera a squadra per gas EN 14800:2007 - attacchi M/M
Angle ball valve with spread for gas with fastening for flexible metallic pipe EN 14800:2007 - threaded ends M/M
Gas-Kugelhahn, eckförmig EN 14800:2007 - AG/AG
Robinet à boisseau sphérique à équerre pour gaz EN 14800:2007 - fixations M/M
Угловой шаровой кран для газа EN 14800:2007 - соединения Н/Н



Cod./Code	DN	Ø	□/田	€
111205010	1/2" x 1/2"	12,5	10/120	

IVR 118 UNI CIG



Rubinetto a sfera a squadra per gas EN 14800:2007 - attacchi M/F
Angle ball valve with spread for gas with fastening for flexible metallic pipe EN 14800:2007 - threaded ends M/F
Gas-Kugelhahn, eckförmig EN 14800:2007 - AG/IG
Robinet à boisseau sphérique à équerre pour gaz EN 14800:2007 - fixations M/F
Угловой шаровой кран для газа EN 14800:2007 - соединения Н/В



Cod./Code	DN	Ø	□/田	€
111805010	1/2" x 1/2"	12,5	10/120	

IVR 113 UNI CIG



Rubinetto a sfera a squadra per gas EN 14800:2007 - attacchi M - Dado folle
Angle ball valve EN 14800:2007 with M connection - Loose nut
Gas-Kugelhahn, eckförmig EN 14800:2007 - Anschlüsse AG - Überwurfmutter
Robinet à boisseau sphérique à équerre pour gaz EN 14800:2007 - fixations M - écrou tournant
Угловой шаровой кран для газа EN 14800:2007 - соединения H - Свободная гайка



Cod./Code	DN	Ø	□/田	€
111305010	1/2" x 1/2"	12,5	10/120	
111305020	1/2" x 3/4"	12,5	10/120	

IVR 114 UNI CIG



Rubinetto a sfera a squadra per gas EN 14800:2007 - attacchi F - Dado folle
Angle ball valve EN 14800:2007 with F connection - Loose nut
Gas-Kugelhahn, eckförmig EN 14800:2007 - Anschlüsse IG - Überwurfmutter
Robinet à boisseau sphérique à équerre pour gaz EN 14800:2007 - fixations F - écrou tournant
Угловой шаровой кран для газа EN 14800:2007 - соединения B - Свободная гайка



Cod./Code	DN	Ø	□/田	€
111405010	1/2" x 1/2"	12,5	10/120	
111405020	1/2" x 3/4"	12,5	10/120	

IVR 116 UNI CIG



Rubinetto a sfera diritto per gas EN 14800:2007 - attacchi M - Dado folle
Straight ball valve EN 14800:2007 with M connection - Loose nut
Gas-Kugelhahn mit gerader Verschraubung EN 14800:2007 AG - Überwurfmutter
Robinet à boisseau sphérique droit pour gaz EN 14800:2007 - fixations M - écrou tournant
Прямой шаровой кран для газа EN 14800:2007 - соединения H - Свободная гайка



Cod./Code	DN	Ø	□/田	€
111605010	1/2" x 1/2"	12,5	10/120	
111605020	1/2" x 3/4"	12,5	10/120	

IVR 117 UNI CIG



Rubinetto a sfera diritto per gas EN 14800:2007 - attacchi F - Dado folle
Straight ball valve EN 14800:2007 with F connection - Loose nut
Gas-Kugelhahn mit gerader Verschraubung EN 14800:2007 - Anschlüsse IG - Überwurfmutter
Robinet à boisseau sphérique droit pour gaz EN 14800:2007 - fixations F - écrou tournant
Прямой шаровой кран для газа EN 14800:2007 - соединения B - Свободная гайка



Cod./Code	DN	Ø	□/田	€
111705010	1/2" x 1/2"	12,5	10/120	
111705020	1/2" x 3/4"	12,5	10/120	



IVR 161 UNI CIG



Rubinetto dritto per gas - attacchi F - portagomma
Straight ball valve for gas - threaded ends F - Rubber hose connection
Gas-Kugelhahn mit Schlauchanschluss - Anschluss IG
Robinet a boisseau spherique pour gaz - fixations F - Porte tuyeau souple
Прямой шаровой кран для газа - соединения В - насадка для резинового шланга



Cod./Code	DN	Ø	□/田	€
116103000	3/8" x 8	12,5	15/90	
116103001	3/8" x 13	12,5	15/90	
116105000	1/2" x 8	12,5	15/90	
116105002	1/2" x 13	12,5	15/90	

IVR 162 UNI CIG



Rubinetto dritto per gas - attacchi M - portagomma
Straight ball valve for gas - threaded ends M - Rubber hose connection
Gas-Kugelhahn mit gerader Verschraubung mit Schlauchanschluss - Anschluss AG
Robinet a boisseau spherique pour gaz - fixations M - Porte tuyeau souple
Прямой шаровой кран для газа - соединения Н - насадка для резинового шланга



Cod./Code	DN	Ø	□/田	€
116203000	3/8" x 8	12,5	15/90	
116203002	3/8" x 13	12,5	15/90	
116205000	1/2" x 8	12,5	15/90	
116205002	1/2" x 13	12,5	15/90	

IVR 193 UNI CIG



Rubinetto angolo per gas - attacchi F - Portagomma
Angle ball valve for gas - threaded ends F - rubber hose connection
Eckförmiger Gas-Kugelhahn mit Schlauchanschluss - Anschluss IG
Robinet a equerre pour gaz - fixations F - porte tuyeau souple
Прямой шаровой кран для газа - соединения В - насадка для резинового шланга



Cod./Code	DN	Ø	□/田	€
119303001	3/8" x 8	12,5	15/90	
119303002	3/8" x 13	12,5	15/90	
119305001	1/2" x 8	12,5	15/90	
119305002	1/2" x 13	12,5	15/90	

IVR 194 UNI CIG



Rubinetto angolo per gas - attacchi M - Portagomma
Angle ball valve for gas - threaded ends M - rubber hose connection
Eckförmiger Gas-Kugelhahn eckförmig mit Schlauchanschluss - Anschlüsse AG
Robinet a equerre pour gaz - fixations M - porte tuyeau souple
Угловой шаровой кран для газа - соединения Н - насадка для резинового шланга



Cod./Code	DN	Ø	□/田	€
119403001	3/8" x 8	12,5	15/90	
119403002	3/8" x 13	12,5	15/90	
119405001	1/2" x 8	12,5	15/90	
119405002	1/2" x 13	12,5	15/90	

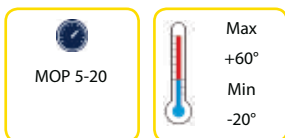

IVR INCASSO

IVR 273 UNI CIG



Rubinetto a sfera da incasso gas con flangetta di fissaggio e perno di supporto - UNI CIG 7129
Completo di leva e attacchi a saldare per tubo rame

Built-in monoblock ball valve for gas, according to standard UNI CIG 7129
Complete with butt weld connections for copper pipe

Gas-Unterputzarmatur-Kugelhahn mit Befestigungsflansch und Auflagestift - UNI CIG 7129 - mit Griff. -
Anschlüsse für Kupferrohr

Robinet à boisseau sphérique à encastrer gaz, avec patte d'ancrage et tasseaux, conforme à la norme
UNI CIG 7129 - pourvu de fixations à souder pour tube en cuivre

Встроенный в моноблок шаровой кран для газа - стандарт UNI CIG7129 - Укомплектован ручкой и
соединениями под пайку для медных труб

EAC

Cod./Code	DN	Ø	□/田	€
127305401	14	14	1	
127305601	16	14	1	



Cod./Code	DN	Ø	□/田	€
127300002	Sportello cromato / Chrome cover		1	



Cod./Code	DN	Ø	□/田	€
127300001	Sportello bianco / White cover		1	

IVR 274



Rubinetto a sfera da incasso gas, ispezionabile come da norma UNI CIG 7129
Completo di attacchi a saldare per tubo rame

Built-in ball valve for gas, openable box for inspection according standard UNI CIG 7129
Complete with butt weld connections for copper pipe

Gas-Unterputzarmatur-Kugelhahn, inspektionierbar gemäß Norm UNI CIG 7129 - Anschlüsse für Kupfer-
rohr zum schweißen

Robinet à boisseau sphérique à encastrer gaz, contrôlable conforme à la norme UNI CIG 7129
Pourvu de fixations à souder pour tube en cuivre

Встраиваемый шаровой кран для газа, инспекционный, согласно норме UNI CIG 7129. Соединение
под сварку для медной трубы

EAC

Cod./Code	DN	Ø	□/田	€
127405401	14	14	1	
127405601	16	14	1	
109770274	Prolunga / Stem extention		1	



IVR GHISA

PN16

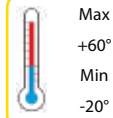

UNI EN 1092

IVR 82



Valvola a sfera in ghisa GJS 400 per gas - attacchi flangiati PN16
Cast iron GJS 400 ball valve for gas - flanged ends PN16
Kugelhahn aus Gusseisen GJS 400 für Gas - Flanschanschlüsse PN16
Vanne à boisseau sphérique en fonte GJS 400 pour gaz - fixations bridées PN16
Фланцевый шаровой кран для газа из чугуна GJS 400 - фланцевые соединения PN 16

Cod./Code	DN	Ø	ISO 5211	□/田	€
108207052	20	20	F04	10	
108210052	25	25	F04	10	
108212052	32	32	F04	5	
108215052	40	40	F05	5	
108220052	50	50	F05	4	
108225052	65	61	F07	2	
108230052	80	74	F07	2	
108240052	100	95	F07	2	
108250012	125	120	F10	1	
108260012	150	145	F10	1	



IVR 82 + IVR 180



IVR 82 - Valvola flangiata in ghisa GJS 400 per gas Attacchi flangiati PN 16
+ IVR 180 - Riduttore di manovra manuale
IVR 82 - Cast iron GJL 400 ball valve for gas - flanged ends PN 16
+ IVR 180 - Manual gearbox
IVR 82 - Flanschkgugelhahn aus Gusseisen GJS 400 für Gas Flanschanschlüsse PN 16
+ IVR 180 - Manuelles Getriebe
IVR 82 - Vanne bride en fonte GJS 400 pour gaz Fixations bridées PN 16
+ IVR 180 - Réducteur de manoeuvre manuelle
IVR 82 Шаровой фланцевый кран для газа из чугуна GJS 400 - фланцевые соединения PN 16
+ IVR 180 - Ручной редуктор управления

Cod./Code	DN	Ø	ISO5211	□/田	€
408215070	40	40	F05	1	
408220070	50	50	F05	1	
408225070	65	61	F07	1	
408230070	80	74	F07	1	
408240070	100	95	F07	1	
408250070	125	120	F10	1	
408260070	150	145	F10	1	



IVR 83



Valvola a sfera in ghisa GJS 400 per gas - asta e sfera inox - attacchi flangiati PN16
Cast iron GJS 400 ball valve for gas - stainless steel stem and ball - flanged ends PN16
Kugelhahn aus Gusseisen GJS 400 für Gas - Stab und Kugel aus Edelstahl - Flanschanschlüsse PN16
Vanne à boisseau sphérique en fonte GJS 400 pour gaz - tige et sphère inox - fixations bridées PN16
Фланцевый шаровой кран для газа из чугуна GJS 400 - Шток и шар из нержавеющей стали - фланцевые соединения PN 16

Cod./Code	DN	Ø	ISO5211	□/田	€
108307052	20	20	F04	10	
108310052	25	25	F04	10	
108312052	32	32	F04	5	
108315052	40	40	F05	5	
108320052	50	50	F05	4	
108325052	65	61	F07	2	
108330052	80	74	F07	2	
108340052	100	95	F07	2	
108350012	125	120	F10	1	
108360012	150	145	F10	1	



IVR 83 + IVR 180



IVR 83 Valvola flangiata in ghisa GJS 400 per gas Asta e sfera inox - att. PN 16
+ IVR 180 Riduttore di manovra manuale
IVR 83 - Cast iron GJS 400 ball valve for gas - s.s. stem and ball Flanged ends PN 16
+ IVR 180 - Manual gearbox
IVR 83 Gas-Flansch-Kugelhahn aus Gusseisen GJS 400 - Stab und Kugel aus Edelstahl - Anschluss
+ IVR 180 Manuelles Getriebe
IVR 83 Vanne bride en fonte GJS 400 pour gaz - tige et sphère inox - att. PN 16
+ Edelstahl - Anschluss PN IVR 180 Réducteur de manoeuvre manuelle
IVR 83 Шаровой фланцевый кран для газа из чугуна GJS 400 - Шток и шар из нержавеющей стали - фланцевые соединения PN 16 + IVR 180 - Ручной редуктор управления

Cod./Code	DN	Ø	ISO5211	□/田	€
408315070	40	40	F05	1	
408320070	50	50	F05	1	
408325070	65	61	F07	1	
408330070	80	74	F07	1	
408340070	100	95	F07	1	
408350070	125	120	F10	1	
408360070	150	145	F10	1	



82 / 83

ACCESSORI / RICAMBI - ACCESSORIES / SPARE PARTS

	20	25	32	40	50	65	80	100	125	150
	702023501			702033501		702053501		702063501		
	750720601			750730801		750740801		750751001		
				118020010		118030010		118050010		
	109710100			109715100		109725100		109740100		
	334206071	334206101	334206121	334206151	334206201	334206251	334206301	334206401	334206501	334206601

IVR 177



Valvola a farfalla in ghisa GJS 400 tipo LUG per gas
Butterfly valve for gas LUG type GJS 400
Ventil mit Flügelgriff aus Gusseisen GJS 400 Typ LUG für Gas
Vanne papillon en fonte GJS 400 type LUG pour gaz
Дисковый затвор «Баттерфляй» для газа из чугуна GJS 400– тип LUG

Cod./Code	DN	Ø	ISO5211	□/田	€
117715001	40	40	F05	3	
117720001	50	50	F05	3	
117725001	65	65	F05	2	
117730001	80	80	F05	2	
117740001	100	100	F07	2	
117750001	125	125	F07	1	
117760001	150	150	F07	1	
117780001	200	200	F10	1	
117790001	250	250	F10	1	
117795001	300	300	F12	1	

IVR 277 CF8M



Valvola a farfalla in ghisa GJS 400 tipo LUG per gas - disco inox CF8M
Butterfly valve for gas LUG type GJS 400 with SS disc CF8M
Ventil mit Flügelgriff aus Gusseisen GJS 400 Typ LUG für Gas - Edelstahlscheibe CF8M
Vanne papillon en fonte GJS 400 type LUG pour gaz disque inox CF8M
Дисковый затвор «Баттерфляй» для газа из чугуна GJS 400 - тип LUG - диск из нержавеющей стали CF8M

Cod./Code	DN	Ø	ISO5211	□/田	€
127715001	40	40	F05	3	
127720001	50	50	F05	3	
127725001	65	65	F05	2	
127730001	80	80	F05	2	
127740001	100	100	F07	2	
127750001	125	125	F07	1	
127760001	150	150	F07	1	
127780001	200	200	F10	1	
127790001	250	250	F10	1	
127795001	300	300	F12	1	

IVR 178



Valvola a farfalla in ghisa GJS 400 tipo WAFER per gas
Butterfly valve for gas WAFER type GJS 400
Ventil mit Flügelgriff aus Gusseisen GJS 400 Typ WAFER für Gas
Vanne papillon en fonte GJS 400 type WAFER pour gaz
Дисковый затвор «Баттерфляй» для газа из чугуна GJS 400– тип WAFER

Cod./Code	DN	Ø	ISO5211	□/田	€
117815001	40	40	F05	3	
117820001	50	50	F05	3	
117825001	65	65	F05	2	
117830001	80	80	F05	2	
117840001	100	100	F07	2	
117850001	125	125	F07	1	
117860001	150	150	F07	1	
117880001	200	200	F10	1	
117890001	250	250	F10	1	
117895001	300	300	F12	1	

IVR 278 CF8M





Valvola a farfalla in ghisa GJS 400 tipo WAFER per gas - disco inox CF8M
Butterfly valve for gas WAFER type GJS 400 with SS disc CF8M
Ventil mit Flügelgriff aus Gusseisen GJS 400 Typ WAFER für Gas - Edelstahlscheibe CF8M
Vanne papillon en fonte GJS 400 type WAFER pour gaz disque inox CF8M
Дисковый затвор «Баттерфляй» для газа из чугуна GJS 400– тип WAFER
– диск из нержавеющей стали CF8M

Cod./Code	DN	Ø	ISO5211	□/田	€
127815001	40	40	F05	3	
127820001	50	50	F05	3	
127825001	65	65	F05	2	
127830001	80	80	F05	2	
127840001	100	100	F07	2	
127850001	125	125	F07	1	
127860001	150	150	F07	1	
127880001	200	200	F10	1	
127890001	250	250	F10	1	
127895001	300	300	F12	1	

WAFER / LUG GAS

ACCESSORI / RICAMBI - ACCESSORIES / SPARE PARTS

	40	50	65	80	100	125	150	200	250	300
	702335151		702335251		702335401	702335501		702335801	702335901	
	117930010				117940010	117960010		117980010	117990010	117995010

