

FEATURES

- Fluidfit products are designed for water, food and air contact but can be used with selected gases, vacuum and liquids
- Easy actions allow the tube to be connected and released quickly, saving time and expenses
- Fluidfit products are made from NSF and ACS approved non-toxic materials

FLUID TYPES

- Water
- Beverages
- Vacuum
- Compressed air
- Gases and liquids suitable with construction materials

WORKING PRESSURES & TEMPERATURES

Working temperatures from -20°C to +98°C dry air, from 1°C to 98°C air and fluids* Pressure up to 20 bar depending on tubes and temperatures applied.

Ø / °C	-20°C	1°C*	25°C*	70°C*	98°C
4 mm 5/32"	0 bar to 8 bar with dry air only	20 bar	20 bar	16 bar	10 bar
6 mm 3/16" 1/4"		20 bar	20 bar	16 bar	10 bar
8 mm 5/16"		20 bar	20 bar	16 bar	10 bar
10 mm 3/8"		16 bar	16 bar	14 bar	10 bar
12 mm 1/2"		14 bar	14 bar	8 bar	6 bar

*Temperatures and pressures indicated refer to NSF standards limits. Please contact our technical sales department for higher temperature and/or pressure application needs.

System performances always depend on fittings, tubes and possible other items and accessories used. Users must cross check the technical features of EACH component in order to avoid possible failures and damages.

TUBE TYPE

PLASTIC - Polyethylene (PE), Polyamide (PA), Polyurethane (PU), PTFE, FEP
SOFT METAL - Brass, Copper, Mild steel
HARD METAL - Please contact our technical sales department for stainless steel and other hard metal tubes.

MAXIMUM TORQUE VALUES

Maximum torque values for BSP, BSPT and NPT plastic threads

Threads	1/8"	1/4"	3/8"	1/2"
Max. torque	1.5 Nm	1.5 Nm	3.0 Nm	3.0 Nm

CERTIFICATIONS & CONFORMITY



MATERIALS

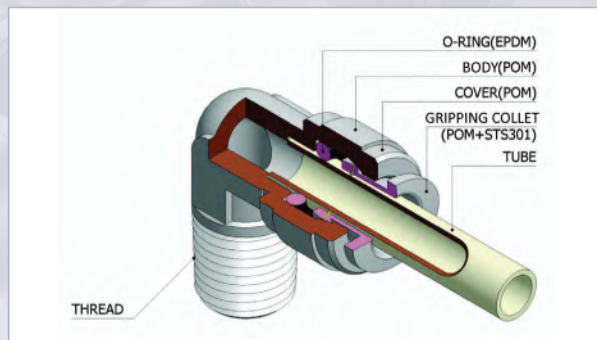



HPC STRAIGHT ADAPTOR



3720

PART NUMBER	TUBE OD	MALE THREAD	PRICE EACH	
			1 - 9	10 +
CDHPC0401	4 mm	1/8" BSPT	£1.04	£0.91
CDHPC0601	6 mm	1/8" BSPT	£1.04	£0.91
CDHPC0602	6 mm	1/4" BSPT	£1.01	£0.89
CDHPC0603	6 mm	3/8" BSPT	£1.16	£1.02
CDHPC0801	8 mm	1/8" BSPT	£1.04	£0.91
CDHPC0802	8 mm	1/4" BSPT	£1.06	£0.92
CDHPC0803	8 mm	3/8" BSPT	£1.18	£1.04
CDHPC1003	10 mm	3/8" BSPT	£1.15	£1.01
CDHPC1004	10 mm	1/2" BSPT	£1.20	£1.06
CDHPC1203	12 mm	3/8" BSPT	£1.21	£1.07
CDHPC1204	12 mm	1/2" BSPT	£1.23	£1.08



HCF-NH FEMALE TAP CONNECTOR



3720

PART NUMBER	TUBE OD	FEMALE THREAD	PRICE EACH	
			1 - 9	10 +
CDHCF06-NH06	6 mm	3/4" BSPP	£5.77	£5.06
CDHCF08-NH06	8 mm	3/4" BSPP	£5.90	£5.17
CDHCF10-NH06	10 mm	3/4" BSPP	£6.02	£5.28



HPC-G STRAIGHT ADAPTOR



3720

PART NUMBER	TUBE OD	MALE THREAD	PRICE EACH	
			1 - 9	10 +
CDHPC04G01	4 mm	1/8" BSPP	£0.96	£0.84
CDHPC04G02	4 mm	1/4" BSPP	£0.99	£0.88
CDHPC06G01	6 mm	1/8" BSPP	£1.09	£0.97
CDHPC06G02	6 mm	1/4" BSPP	£1.10	£0.97
CDHPC08G01	8 mm	1/8" BSPP	£1.15	£1.01
CDHPC08G02	8 mm	1/4" BSPP	£1.16	£1.01
CDHPC08G03	8 mm	3/8" BSPP	£1.16	£1.02
CDHPC08G04	8 mm	1/2" BSPP	£1.20	£1.06
CDHPC10G02	10 mm	1/4" BSPP	£1.23	£1.08
CDHPC10G03	10 mm	3/8" BSPP	£1.24	£1.09
CDHPC10G04	10 mm	1/2" BSPP	£1.29	£1.14
CDHPC12G03	12 mm	3/8" BSPP	£1.33	£1.17
CDHPC12G04	12 mm	1/2" BSPP	£1.43	£1.26
CDHPC15G04	15 mm	1/2" BSPP	£2.31	£2.03
CDHPC15G06	15 mm	3/4" BSPP	£3.31	£2.90
CDHPC22G06	22 mm	3/4" BSPP	£4.07	£3.58



HCF-G STEM ADAPTOR



3720

PART NUMBER	STEM OD	MALE THREAD	PRICE EACH	
			1 - 9	10 +
CDHCJ0401	4 mm	1/8" BSPT	£0.61	£0.54
CDHCJ0402	4 mm	1/4" BSPT	£0.61	£0.54
CDHCJ0601	6 mm	1/8" BSPT	£0.63	£0.55
CDHCJ0602	6 mm	1/4" BSPT	£0.64	£0.56
CDHCJ0801	8 mm	1/8" BSPT	£0.61	£0.54
CDHCJ0802	8 mm	1/4" BSPT	£0.64	£0.56
CDHCJ0803	8 mm	3/8" BSPT	£0.67	£0.59
CDHCJ1002	10 mm	1/4" BSPT	£0.67	£0.59
CDHCJ1003	10 mm	3/8" BSPT	£0.69	£0.61
CDHCJ1004	10 mm	1/2" BSPT	£0.76	£0.67
CDHCJ1203	12 mm	3/8" BSPT	£0.77	£0.68
CDHCJ1204	12 mm	1/2" BSPT	£0.84	£0.74



HCF-G FEMALE STRAIGHT



3720

PART NUMBER	TUBE OD	FEMALE THREAD	PRICE EACH	
			1 - 9	10 +
CDHCF04G01	4 mm	1/8" BSPP	£1.33	£1.16
CDHCF06G01	6 mm	1/8" BSPP	£1.18	£1.05
CDHCF06G02	6 mm	1/4" BSPP	£1.23	£1.08
CDHCF06G03	6 mm	3/8" BSPP	£1.34	£1.17
CDHCF08G01	8 mm	1/8" BSPP	£1.27	£1.12
CDHCF08G02	8 mm	1/4" BSPP	£1.33	£1.17
CDHCF08G03	8 mm	3/8" BSPP	£1.30	£1.15
CDHCF08G04	8 mm	1/2" BSPP	£1.53	£1.34
CDHCF08G06	8 mm	3/4" BSPP	£5.08	£4.45
CDHCF10G02	10 mm	1/4" BSPP	£1.43	£1.25
CDHCF10G03	10 mm	3/8" BSPP	£1.48	£1.30
CDHCF10G04	10 mm	1/2" BSPP	£1.55	£1.37
CDHCF10G06	10 mm	3/4" BSPP	£5.50	£4.82
CDHCF12G02	12 mm	1/4" BSPP	£1.43	£1.25
CDHCF12G03	12 mm	3/8" BSPP	£1.56	£1.37
CDHCF12G04	12 mm	1/2" BSPP	£1.57	£1.38
CDHCF15G06	15 mm	3/4" BSPP	£3.58	£3.14



HCF-G STEM ADAPTOR



3720

PART NUMBER	STEM OD	MALE THREAD	PRICE EACH	
			1 - 9	10 +
CDHCJ04G01	4 mm	1/8" BSPP	£0.61	£0.54
CDHCJ04G02	4 mm	1/4" BSPP	£0.63	£0.56
CDHCJ06G01	6 mm	1/8" BSPP	£0.63	£0.56
CDHCJ06G02	6 mm	1/4" BSPP	£0.65	£0.58
CDHCJ08G01	8 mm	1/8" BSPP	£0.65	£0.58
CDHCJ08G02	8 mm	1/4" BSPP	£0.67	£0.59
CDHCJ08G03	8 mm	3/8" BSPP	£0.70	£0.62
CDHCJ10G02	10 mm	1/4" BSPP	£0.71	£0.62
CDHCJ10G03	10 mm	3/8" BSPP	£0.77	£0.68
CDHCJ10G04	10 mm	1/2" BSPP	£0.82	£0.72
CDHCJ12G03	12 mm	3/8" BSPP	£0.83	£0.73
CDHCJ12G04	12 mm	1/2" BSPP	£0.87	£0.77
CDHCJ15G04	15 mm	1/2" BSPP	£1.40	£1.23

New



HMM BULKHEAD



3720

PART NUMBER	TUBE OD	PRICE EACH	
		1 - 9	10 +
CDHMM0404	4 mm	£1.51	£1.32
CDHMM0606	6 mm	£1.54	£1.35
CDHMM0808	8 mm	£1.63	£1.43
CDHMM1010	10 mm	£1.88	£1.65
CDHMM1212	12 mm	£2.25	£1.97

REDUCING BULKHEAD

PART NUMBER	TUBE OD	TUBE OD	PRICE EACH	
			1 - 9	10 +
CDHMM0604	6 mm	4 mm	£1.71	£1.50
CDHMM0806	8 mm	6 mm	£1.86	£1.63

B



A



HLJ STEM ELBOW

3720

PART NUMBER	STEM OD (A)	TUBE OD (B)	PRICE EACH	
			1 - 9	10 +
CDHLJ0404	4 mm	4 mm	£1.00	£0.88
CDHLJ0606	6 mm	6 mm	£1.08	£0.96
CDHLJ0808	8 mm	8 mm	£1.15	£1.00
CDHLJ1010	10 mm	10 mm	£1.16	£1.02
CDHLJ1212	12 mm	12 mm	£1.30	£1.15
CDHLJ1515	15 mm	15 mm	£2.54	£2.23

REDUCING STEM ELBOW

PART NUMBER	TUBE OD	TUBE OD	PRICE EACH	
			1 - 9	10 +
CDHLJ0608	6 mm	8 mm	£1.18	£1.04
CDHLJ1006	10 mm	6 mm	£1.27	£1.12
CDHLJ1008	10 mm	8 mm	£1.33	£1.17

New

Additions



HUC EQUAL UNION STRAIGHT



3720

PART NUMBER	TUBE OD	PRICE EACH	
		1 - 9	10 +
CDHUC0404	4 mm	£1.07	£0.93
CDHUC0606	6 mm	£1.14	£1.00
CDHUC0808	8 mm	£1.28	£1.12
CDHUC1010	10 mm	£1.43	£1.26
CDHUC1212	12 mm	£1.48	£1.30
CDHUC1515	15 mm	£2.79	£2.46
CDHUC2222	22 mm	£4.17	£3.67

REDUCING UNION STRAIGHT

PART NUMBER	TUBE OD	TUBE OD	PRICE EACH	
			1 - 9	10 +
CDHUC0604	6 mm	4 mm	£1.16	£1.02
CDHUC0605	6 mm	5 mm	£1.18	£1.04
CDHUC0806	8 mm	6 mm	£1.30	£1.15
CDHUC1006	10 mm	6 mm	£1.42	£1.25
CDHUC1008	10 mm	8 mm	£1.43	£1.25
CDHUC1210	12 mm	10 mm	£1.47	£1.29

New

Additions



HPL RIGID ELBOW



3720

PART NUMBER	TUBE OD	MALE THREAD	PRICE EACH	
			1 - 9	10 +
CDHPL0401	4 mm	1/8" BSPT	£1.06	£0.93
CDHPL0601	6 mm	1/8" BSPT	£1.04	£0.91
CDHPL0602	6 mm	1/4" BSPT	£1.05	£0.91
CDHPL0603	6 mm	3/8" BSPT	£1.12	£1.01
CDHPL0802	8 mm	1/4" BSPT	£1.09	£0.97
CDHPL0803	8 mm	3/8" BSPT	£1.16	£1.01
CDHPL1002	10 mm	1/4" BSPT	£1.20	£1.06
CDHPL1003	10 mm	3/8" BSPT	£1.12	£0.99
CDHPL1202	12 mm	1/4" BSPT	£1.30	£1.15
CDHPL1203	12 mm	3/8" BSPT	£1.87	£1.64
CDHPL1204	12 mm	1/2" BSPT	£1.30	£1.15

New

Additions



HUL EQUAL ELBOW



3720

PART NUMBER	TUBE OD	PRICE EACH	
		1 - 9	10 +
CDHUL0404	4 mm	£1.15	£1.00
CDHUL0606	6 mm	£1.17	£1.04
CDHUL0808	8 mm	£1.24	£1.09
CDHUL1010	10 mm	£1.29	£1.14
CDHUL1212	12 mm	£1.36	£1.19
CDHUL1515	15 mm	£3.13	£2.75
CDHUL2222	22 mm	£5.85	£5.13

REDUCING ELBOW

PART NUMBER	TUBE OD	TUBE OD	PRICE EACH	
			1 - 9	10 +
CDHUL0804	8 mm	4 mm	£1.48	£1.30
CDHUL0806	8 mm	6 mm	£1.22	£1.07
CDHUL1006	10 mm	6 mm	£1.74	£1.52
CDHUL1008	10 mm	8 mm	£1.33	£1.17
CDHUL1206	12 mm	6 mm	£1.37	£1.20
CDHUL1208	12 mm	8 mm	£1.36	£1.19
CDHUL1210	12 mm	10 mm	£1.74	£1.52

New

Additions



HGJ STEM REDUCER



3720

PART NUMBER	TUBE OD (A)	STEM OD (B)	PRICE EACH	
			1 - 9	10 +
CDHGJ0604	6 mm	4 mm	£0.88	£0.78
CDHGJ0804	8 mm	4 mm	£1.42	£1.25
CDHGJ0806	8 mm	6 mm	£0.93	£0.82
CDHGJ0810	8 mm	10 mm	£1.12	£0.99
CDHGJ1006	10 mm	6 mm	£1.12	£0.99
CDHGJ1008	10 mm	8 mm	£1.12	£0.99
CDHGJ1208	12 mm	8 mm	£1.84	£1.61
CDHGJ1210	12 mm	10 mm	£1.87	£1.64
CDHGJ1510	15 mm	10 mm	£1.86	£1.64
CDHGJ1512	15 mm	12 mm	£1.86	£1.64

New Additions



HUT EQUAL TEE



3720

PART NUMBER	TUBE OD	PRICE EACH	
		1 - 9	10 +
CDHUT0404	4 mm	£1.43	£1.26
CDHUT0606	6 mm	£1.51	£1.33
CDHUT0808	8 mm	£1.58	£1.39
CDHUT1010	10 mm	£1.81	£1.60
CDHUT1212	12 mm	£1.89	£1.66
CDHUT1515	15 mm	£4.42	£3.88
CDHUT2222	22 mm	£8.02	£7.05

New Additions



HPP PLUG



3720

PART NUMBER	TUBE OD	PRICE EACH	
		1 - 9	10 +
CDHPP04	4 mm	£0.41	£0.36
CDHPP06	6 mm	£0.44	£0.40
CDHPP08	8 mm	£0.46	£0.41
CDHPP10	10 mm	£0.48	£0.42
CDHPP12	12 mm	£0.65	£0.57
CDHPP15	15 mm	£0.79	£0.69
CDHPP22	22 mm	£0.97	£0.86

REDUCING TEE

PART NUMBER	TUBE OD	TUBE OD	TUBE OD	PRICE EACH	
				1 - 9	10 +
CDHUT100610	10 mm	6 mm	10 mm	£1.83	£1.61
CDHUT100810	10 mm	8 mm	10 mm	£2.14	£1.89
CDHUT121012	12 mm	10 mm	12 mm	£1.81	£1.58
CDHUT221222	22 mm	12 mm	22 mm	£7.59	£6.65
CDHUT221522	22 mm	15 mm	22 mm	£7.63	£6.69



HUY EQUAL UNION Y

3720

PART NUMBER	TUBE OD (A)	TUBE OD (B)	PRICE EACH	
			1 - 9	10 +
CDHUY0404	4 mm	4 mm	£1.54	£1.35
CDHUY0606	6 mm	6 mm	£1.64	£1.44
CDHUY0808	8 mm	8 mm	£1.74	£1.53
CDHUY1008	10 mm	8 mm	£2.04	£1.80
CDHUY1010	10 mm	10 mm	£1.93	£1.70
CDHUY1212	12 mm	12 mm	£2.00	£1.75

New Additions



HPF END CAP



3720

PART NUMBER	TUBE OD	PRICE EACH	
		1 - 9	10 +
CDHPP06	6 mm	£1.02	£0.90
CDHPP08	8 mm	£1.05	£0.92
CDHPP10	10 mm	£1.21	£1.06
CDHPP12	12 mm	£1.31	£1.15
CDHPP15	15 mm	£1.66	£1.46
CDHPP22	22 mm	£2.14	£1.88

New



HZA METRIC EQUAL CROSS



3720

PART NUMBER	TUBE OD	PRICE EACH	
		1 - 9	10 +
CDHZA0606	6 mm	£2.67	£2.34

New Additions



HCP CLIP



3720

PART NUMBER	TUBE OD	PRICE EACH	
		1 - 9	10 +
CDHCP04	4 mm	£0.09	£0.08
CDHCP05	5 mm	£0.09	£0.08
CDHCP06	6 mm	£0.09	£0.08
CDHCP08	8 mm	£0.09	£0.08
CDHCP10	10 mm	£0.09	£0.08
CDHCP12	12 mm	£0.09	£0.08

New



HRPL
BSPT SWIVEL ELBOW

3720

PART NUMBER	TUBE	MALE THREAD	PRICE EACH	
			1 - 9	10 +
CDHRPL0601	6 mm	1/8" BSPT	£1.80	£1.58
CDHRPL0602	6 mm	1/4" BSPT	£1.81	£1.59
CDHRPL0801	8 mm	1/8" BSPT	£1.84	£1.62
CDHRPL0802	8 mm	1/4" BSPT	£1.87	£1.64
CDHRPL0803	8 mm	3/8" BSPT	£1.89	£1.66
CDHRPL1003	10 mm	3/8" BSPT	£1.98	£1.74

New



HRST
BSPT SWIVEL RUN TEE

3720

PART NUMBER	TUBE	MALE THREAD	PRICE EACH	
			1 - 9	10 +
CDHRST0601	6 mm	1/8" BSPT	£2.13	£1.87
CDHRST0602	6 mm	1/4" BSPT	£2.15	£1.89
CDHRST0801	8 mm	1/8" BSPT	£2.19	£1.92
CDHRST0802	8 mm	1/4" BSPT	£2.22	£1.95
CDHRST0803	8 mm	3/8" BSPT	£2.24	£1.96
CDHRST1003	10 mm	3/8" BSPT	£2.49	£2.19

New



HRPL-G
BSPP SWIVEL ELBOW

3720

PART NUMBER	TUBE	MALE THREAD	PRICE EACH	
			1 - 9	10 +
CDHRPL08G01	8 mm	1/8" BSPP	£1.89	£1.65
CDHRPL08G02	8 mm	1/4" BSPP	£1.89	£1.66
CDHRPL08G03	8 mm	3/8" BSPP	£1.93	£1.69
CDHRPL10G02	10 mm	1/4" BSPP	£2.00	£1.75
CDHRPL10G03	10 mm	3/8" BSPP	£2.06	£1.81
CDHRPL10G04	10 mm	1/2" BSPP	£2.12	£1.86
CDHRPL12G03	12 mm	3/8" BSPP	£2.18	£1.91

New



HRST-G
BSPP SWIVEL RUN TEE

3720

PART NUMBER	TUBE	MALE THREAD	PRICE EACH	
			1 - 9	10 +
CDHRST08G01	6 mm	1/8" BSPP	£2.23	£1.96
CDHRST08G02	8 mm	1/4" BSPP	£2.24	£1.97
CDHRST08G03	8 mm	3/8" BSPP	£2.28	£2.00
CDHRST10G02	10 mm	1/4" BSPP	£2.51	£2.20
CDHRST10G03	10 mm	3/8" BSPP	£2.57	£2.26
CDHRST10G04	10 mm	1/2" BSPP	£2.62	£2.30
CDHRST12G03	12 mm	3/8" BSPP	£2.71	£2.38

New



HRPT
BSPT SWIVEL TEE

3720

PART NUMBER	TUBE	MALE THREAD	PRICE EACH	
			1 - 9	10 +
CDHRPT0601	6 mm	1/8" BSPT	£2.13	£1.87
CDHRPT0602	6 mm	1/4" BSPT	£2.15	£1.89
CDHRPT0801	8 mm	1/8" BSPT	£2.19	£1.92
CDHRPT0802	8 mm	1/4" BSPT	£2.22	£1.95
CDHRPT0803	8 mm	3/8" BSPT	£2.24	£1.96
CDHRPT1003	10 mm	3/8" BSPT	£2.49	£2.19

New



HRWT
BSPT SWIVEL Y

3720

PART NUMBER	TUBE	MALE THREAD	PRICE EACH	
			1 - 9	10 +
CDHRWT0601	6 mm	1/8" BSPT	£2.27	£1.99
CDHRWT0602	6 mm	1/4" BSPT	£2.28	£2.00
CDHRWT0801	8 mm	1/8" BSPT	£2.35	£2.06
CDHRWT0802	8 mm	1/4" BSPT	£2.38	£2.08
CDHRWT0803	8 mm	3/8" BSPT	£2.39	£2.10
CDHRWT1003	10 mm	3/8" BSPT	£2.62	£2.29

New



HRPT-G
BSPP SWIVEL TEE

3720

PART NUMBER	TUBE	MALE THREAD	PRICE EACH	
			1 - 9	10 +
CDHRPT08G01	8 mm	1/8" BSPP	£2.19	£1.92
CDHRPT08G02	8 mm	1/4" BSPP	£2.24	£1.97
CDHRPT08G03	8 mm	3/8" BSPP	£2.28	£2.00
CDHRPT10G02	10 mm	1/4" BSPP	£2.51	£2.20
CDHRPT10G03	10 mm	3/8" BSPP	£2.57	£2.26
CDHRPT10G04	10 mm	1/2" BSPP	£2.62	£2.30
CDHRPT12G03	12 mm	3/8" BSPP	£2.71	£2.38

New



HRWT-G
BSPP SWIVEL Y

3720

PART NUMBER	TUBE	MALE THREAD	PRICE EACH	
			1 - 9	10 +
CDHRWT08G01	8 mm	1/8" BSPP	£2.39	£2.09
CDHRWT08G02	8 mm	1/4" BSPP	£2.40	£2.10
CDHRWT08G03	8 mm	3/8" BSPP	£2.43	£2.13
CDHRWT10G02	10 mm	1/4" BSPP	£2.63	£2.31
CDHRWT10G03	10 mm	3/8" BSPP	£2.69	£2.36
CDHRWT10G04	10 mm	1/2" BSPP	£2.75	£2.41
CDHRWT12G03	12 mm	3/8" BSPP	£2.82	£2.47

New



HCVB HOSETAIL VALVED CONNECTOR



3720

PART NUMBER	TUBE OD (A)	HOSE ID (B)	PRICE EACH	
			1 - 9	10 +
CDHCVB15-1/2	15 mm	1/2"	£4.07	£3.57
CDHCVB22-1/2	22 mm	1/2"	£4.73	£4.14
CDHCVB22-3/4	22 mm	3/4"	£5.39	£4.73

New

Additions

HCBB STRAIGHT HOSETAIL



3720

PART NUMBER	TUBE OD (A)	HOSE ID (B)	PRICE EACH	
			1 - 9	10 +
CDHCBB1210	12 mm	10 mm	£1.68	£1.48
CDHCBB15-1/2	15 mm	1/2"	£1.40	£1.24
CDHCBB22-1/2	22 mm	1/2"	£2.27	£1.99
CDHCBB22-3/4	22 mm	3/4"	£2.36	£2.08

New



HCJB STEM STRAIGHT



3720

PART NUMBER	STEM OD (A)	HOSE ID (B)	PRICE EACH	
			1 - 9	10 +
CDHCJB0604	6 mm	4 mm	£0.70	£0.61
CDHCJB0606	6 mm	6 mm	£0.70	£0.61
CDHCJB0806	8 mm	6 mm	£0.70	£0.62
CDHCJB1006	10 mm	6 mm	£0.71	£0.62
CDHCJB1008	10 mm	8 mm	£0.71	£0.62

New



HLJB STEM ELBOW



3720

PART NUMBER	STEM OD (A)	HOSE ID (B)	PRICE EACH	
			1 - 9	10 +
CDHLJB1006	10 mm	6 mm	£0.73	£0.64
CDHLJB1008	10 mm	8 mm	£0.72	£0.63

BRASS FITTINGS

New

Additions

HCAS BRASS TUBE INSERT F TYPE CARTRIDGE



3720

PART NUMBER	TUBE OD	PRICE EACH	
		1 - 9	10 +
CDHCAS-F04	4 mm	£1.36	£1.19
CDHCAS-F06	6 mm	£1.56	£1.37
CDHCAS-F08	8 mm	£1.72	£1.51
CDHCAS-F10	10 mm	£1.90	£1.66
CDHCAS-F12	12 mm	£2.16	£1.90

New

Additions

HCAS BRASS TUBE INSERT H TYPE CARTRIDGE



3720

PART NUMBER	TUBE OD	PRICE EACH	
		1 - 9	10 +
CDHCAS-H04	4 mm	£1.10	£0.97
CDHCAS-H06	6 mm	£1.17	£1.04
CDHCAS-H08	8 mm	£1.17	£1.02
CDHCAS-H10	10 mm	£1.35	£1.19
CDHCAS-H12	12 mm	£1.87	£1.64

METRIC FLOW REGULATORS

New



HSLB ELBOW



3720

PART NUMBER	TUBE OD	PRICE EACH	
		1 - 9	10 +
CDHSLB0606	6 mm	£8.94	£7.84
CDHSLB1010	10 mm	£10.71	£9.39

New



HSTB IN-LINE



3720

PART NUMBER	TUBE OD	PRICE EACH	
		1 - 9	10 +
CDHSTB0606	6 mm	£8.94	£7.84
CDHSTB1010	10 mm	£10.71	£9.39

METRIC CHECK VALVES

New



HCVU NON-RETURN CHECK VALVE



3720

PART NUMBER	TUBE OD	PRICE EACH	
		1 - 9	10 +
CDHCVU0404	4 mm	£8.22	£7.20
CDHCVU0606	6 mm	£8.23	£7.23
CDHCVU0808	8 mm	£8.72	£7.67
CDHCVU1010	10 mm	£9.22	£8.10
CDHCVU1212	12 mm	£9.69	£8.52

New



**HPC-G
STRAIGHT ADAPTOR**



3720

PART NUMBER	TUBE	THREAD	PRICE EACH	
			1 - 9	10 +
CDHPC3/16-G01	3/16"	1/8"	£1.00	£0.88
CDHPC1/4-G01	1/4"	1/8"	£1.12	£0.99
CDHPC1/4-G02	1/4"	1/4"	£1.17	£1.02
CDHPC5/16-G01	5/16"	1/8"	£1.03	£0.91
CDHPC5/16-G02	5/16"	1/4"	£1.06	£0.93
CDHPC5/16-G03	5/16"	3/8"	£1.12	£0.99
CDHPC3/8-G02	3/8"	1/4"	£1.29	£1.13
CDHPC3/8-G03	3/8"	3/8"	£1.30	£1.14
CDHPC1/2-G04	1/2"	1/2"	£1.57	£1.38

New



**HCF
STRAIGHT ADAPTOR**



3720

PART NUMBER	TUBE	THREAD	PRICE EACH	
			1 - 9	10 +
CDHCF1/4-G04	1/4"	1/2"	£1.53	£1.34
CDHCF1/4-G06	1/4"	3/4"	£6.00	£5.26
CDHCF3/8-G04	3/8"	1/2"	£1.57	£1.38
CDHCF3/8-G04H	3/8"	1/2"	£2.06	£1.80
CDHCF3/8-G05	3/8"	5/8"	£2.16	£1.89
CDHCF3/8-G05H	3/8"	5/8"	£2.12	£1.86
CDHCF3/8-G06	3/8"	3/4"	£5.41	£4.75
CDHCF1/2-G04	1/2"	1/2"	£2.36	£2.07

New



**HRPL
BSPP SWIVEL ELBOW**



3720

PART NUMBER	TUBE	THREAD	PRICE EACH	
			1 - 9	10 +
CDHRPL1/4-G01	1/4"	1/8"	£1.84	£1.61
CDHRPL1/4-G02	1/4"	1/4"	£1.87	£1.64
CDHRPL3/8-G02	3/8"	1/4"	£2.06	£1.80
CDHRPL3/8-G03	3/8"	3/8"	£2.11	£1.85

New



**HRST
BSPP SWIVEL RUN TEE**



3720

PART NUMBER	TUBE	THREAD	PRICE EACH	
			1 - 9	10 +
CDHRST1/4-G01	1/4"	1/8"	£2.24	£1.97
CDHRST1/4-G02	1/4"	1/4"	£2.28	£2.00
CDHRST3/8-G02	3/8"	1/4"	£2.54	£2.23
CDHRST3/8-G03	3/8"	3/8"	£2.60	£2.28

Eleven

New



**HRPT
BSPP SWIVEL TEE**



3720

PART NUMBER	TUBE	THREAD	PRICE EACH	
			1 - 9	10 +
CDHRPT1/4-G01	1/4"	1/8"	£2.24	£1.97
CDHRPT1/4-G02	1/4"	1/4"	£2.28	£2.00
CDHRPT3/8-G02	3/8"	1/4"	£2.54	£2.23
CDHRPT3/8-G03	3/8"	3/8"	£2.60	£2.28

New



**HRWT
BSPP SWIVEL Y**



3720

PART NUMBER	TUBE	THREAD	PRICE EACH	
			1 - 9	10 +
CDHRWT1/4-G01	1/4"	1/8"	£2.27	£1.99
CDHRWT1/4-G02	1/4"	1/4"	£2.30	£2.01
CDHRWT3/8-G02	3/8"	1/4"	£2.54	£2.23
CDHRWT3/8-G03	3/8"	3/8"	£2.60	£2.28

New Additions



**HUC
EQUAL UNION STRAIGHT**



3720

PART NUMBER	TUBE OD	PRICE EACH	
		1 - 9	10 +
CDHUC5/32	5/32"	£1.17	£1.04
CDHUC3/16	3/16"	£1.17	£1.04
CDHUC1/4	1/4"	£1.14	£1.00
CDHUC5/16	5/16"	£1.28	£1.12
CDHUC3/8	3/8"	£1.65	£1.26
CDHUC1/2	1/2"	£1.76	£1.30

New Additions



**HUL
EQUAL ELBOW**



3720

PART NUMBER	TUBE OD	PRICE EACH	
		1 - 9	10 +
CDHUL5/32	5/32"	£1.16	£1.01
CDHUL3/16	3/16"	£1.19	£1.06
CDHUL1/4	1/4"	£1.20	£1.06
CDHUL5/16	5/16"	£1.23	£1.08
CDHUL3/8	3/8"	£1.37	£1.21
CDHUL1/2	1/2"	£1.73	£1.52

REDUCING UNION STRAIGHT

PART NUMBER	TUBE OD	TUBE OD	PRICE EACH	
			1 - 9	10 +
CDHUC5/16-5/32	5/16"	5/32"	£1.33	£1.17
CDHUC5/16-1/4	5/16"	1/4"	£1.28	£1.12
CDHUC3/8-1/4	3/8"	1/4"	£1.65	£1.45
CDHUC3/8-5/16	3/8"	5/16"	£1.66	£1.46
CDHUC1/2-5/16	1/2"	5/16"	£1.73	£1.53
CDHUC1/2-3/8	1/2"	3/8"	£1.72	£1.51

REDUCING ELBOW

PART NUMBER	TUBE OD	TUBE OD	PRICE EACH	
			1 - 9	10 +
CDHUL5/16-5/32	5/16"	5/32"	£1.32	£1.16
CDHUL5/16-1/4	5/16"	1/4"	£1.36	£1.19
CDHUL3/8-5/16	3/8"	5/16"	£1.56	£1.37
CDHUL1/2-3/8	1/2"	3/8"	£1.76	£1.55

 **HUT**
EQUAL TEE



3720

PART NUMBER	TUBE OD	PRICE EACH	
		1 - 9	10 +
CDHUT5/32	5/32"	£1.58	£1.39
CDHUT3/16	3/16"	£1.58	£1.39
CDHUT1/4	1/4"	£1.61	£1.33
CDHUT5/16	5/16"	£1.68	£1.39
CDHUT3/8	3/8"	£1.86	£1.64
CDHUT1/2	1/2"	£2.13	£1.88

 **HPF**
END CAP



3720

PART NUMBER	TUBE OD	PRICE EACH	
		1 - 9	10 +
CDHPPF1/4	1/4"	£0.95	£0.84
CDHPPF5/16	5/16"	£0.99	£0.87
CDHPPF3/8	3/8"	£1.12	£0.99
CDHPPF1/2	1/2"	£1.23	£1.08

 **HUY**
EQUAL UNION Y



3720

PART NUMBER	TUBE OD	PRICE EACH	
		1 - 9	10 +
CDHUY5/32	5/32"	£1.54	£1.35
CDHUY3/16	3/16"	£1.63	£1.43
CDHUY1/4	1/4"	£1.63	£1.43
CDHUY5/16	5/16"	£1.74	£1.53
CDHUY3/8	3/8"	£1.93	£1.70
CDHUY1/2	1/2"	£2.13	£1.88

 **HBU**
U BEND



3720

PART NUMBER	TUBE OD	PRICE EACH	
		1 - 9	10 +
CDHBU1/2-1/2	1/2"	£2.08	£1.82

 **HMM**
BULKHEAD



3720

PART NUMBER	TUBE OD	TUBE OD	PRICE EACH	
			1 - 9	10 +
CDHMM5/32	5/32"	5/32"	£1.51	£1.33
CDHMM1/4	1/4"	1/4"	£1.56	£1.37
CDHMM5/16	5/16"	5/16"	£1.76	£1.55
CDHMM3/8	3/8"	3/8"	£1.89	£1.65
CDHMM1/2	1/2"	1/2"	£2.31	£2.03

REDUCING BULKHEAD

CDHMM1/4-3/8	1/4"	3/8"	£2.04	£1.80
--------------	------	------	-------	-------

 **HGJ**
STEM REDUCER



3720

PART NUMBER	TUBE OD (A)	STEM OD (B)	PRICE EACH	
			1 - 9	10 +
CDHGJ1/4-5/32	1/4"	5/32"	£0.96	£0.84
CDHGJ5/16-1/4	5/16"	1/4"	£0.95	£0.83
CDHGJ3/8-1/4	3/8"	1/4"	£1.08	£0.96
CDHGJ3/8-5/16	3/8"	5/16"	£1.07	£0.93
CDHGJ1/2-3/8	1/2"	3/8"	£1.67	£1.02

 **HPP**
PLUG



3720

PART NUMBER	TUBE OD	PRICE EACH	
		1 - 9	10 +
CDHPP5/32	5/32"	£0.42	£0.37
CDHPP3/16	3/16"	£0.42	£0.37
CDHPP1/4	1/4"	£0.45	£0.40
CDHPP5/16	5/16"	£0.43	£0.38
CDHPP3/8	3/8"	£0.48	£0.42
CDHPP1/2	1/2"	£0.65	£0.57

 **HLJ**
STEM ELBOW



3720

PART NUMBER	TUBE OD (A)	STEM OD (B)	PRICE EACH	
			1 - 9	10 +
CDHLJ5/32	5/32"	5/32"	£1.00	£0.88
CDHLJ3/16	3/16"	3/16"	£1.02	£0.90
CDHLJ1/4	1/4"	1/4"	£1.02	£0.90
CDHLJ5/16	5/16"	5/16"	£1.12	£0.99
CDHLJ3/8	3/8"	3/8"	£1.17	£1.02
CDHLJ1/2	1/2"	1/2"	£1.54	£1.35

REDUCING STEM ELBOW

CDHLJ3/8-1/4	3/8"	1/4"	£1.12	£0.99
CDHLJ3/8-5/16	3/8"	5/16"	£1.29	£1.14

 **HCP**
CLIP



3720

PART NUMBER	TUBE OD	PRICE EACH	
		1 - 9	10 +
CDHCP5/32	5/32"	£0.09	£0.08
CDHCP3/16	3/16"	£0.09	£0.08
CDHCP1/4	1/4"	£0.09	£0.08
CDHCP5/16	5/16"	£0.09	£0.08
CDHCP3/8	3/8"	£0.09	£0.08
CDHCP1/2	1/2"	£0.09	£0.08



New

**HLJB
STEM ELBOW**

3720

PART NUMBER	STEM OD (A)	HOSE OD (B)	PRICE EACH	
			1 - 9	10 +
CDHLJB3/8-5/16	5/16"	3/8"	£0.73	£0.64
CDHLJB3/8-3/8	3/8"	3/8"	£0.74	£0.65



New

**HCJB
STEM STRAIGHT**

3720

PART NUMBER	STEM OD (A)	HOSE OD (B)	PRICE EACH	
			1 - 9	10 +
CDHCJB1/4-1/4	1/4"	1/4"	£0.69	£0.60
CDHCJB5/16-5/16	5/16"	5/16"	£0.70	£0.62
CDHCJB3/8-3/8	3/8"	3/8"	£0.71	£0.62
CDHCJB3/8-5/16	5/16"	3/8"	£0.71	£0.62
CDHCJB1/2-3/8	3/8"	1/2"	£0.73	£0.64

IMPERIAL FLOW REGULATORS



New

**HSLB
ELBOW FLOW REGULATOR**

3720

PART NUMBER	TUBE OD	PRICE EACH	
		1 - 9	10 +
CDHSLB1/4-1/4	1/4"	£8.94	£7.84
CDHSLB3/8-3/8	3/8"	£10.71	£9.39



New

**HSTB
IN-LINE FLOW REGULATOR**

3720

PART NUMBER	TUBE OD	PRICE EACH	
		1 - 9	10 +
CDHSTB1/4-1/4	1/4"	£8.94	£7.84
CDHSTB3/8-3/8	3/8"	£10.71	£9.39

IMPERIAL THREAD TO THREAD

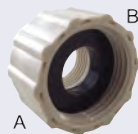

New

**HUFF
THREADED FEMALE REDUCER**

3720

PART NUMBER	TUBE OD (A)	THREAD (B)	PRICE EACH	
			1 - 9	10 +
CDHUFF-G02-G06	1/4"	3/4"	£1.78	£1.56
CDHUFF-G03-G06	3/8"	3/4"	£2.24	£1.97

IMPERIAL CHECK VALVES



New

**HCVU
NON-RETURN CHECK VALVE**

3720

PART NUMBER	TUBE OD	PRICE EACH	
		1 - 9	10 +
CDHCVU1/4	1/4"	£8.23	£7.23
CDHCVU5/16	5/16"	£8.72	£7.67
CDHCVU3/8	3/8"	£9.22	£8.10
CDHCVU1/2	1/2"	£9.69	£8.52

ONE TOUCH 20 BAR HIGH PRESSURE - BLACK

FEATURES

- Smaller fittings, featuring wider working pressure and temperature ranges
- One touch, push-to-connect configuration allows instant tubing connection
- Main body of PL and PT types is a rotating structure for efficient piping
- The section has an O-ring or Teflon coating

APPLICATIONS

- One touch type pipe connection tool for air pressure piping
- Various uses depending on the user's environment

SPECIFICATIONS

Fluid type	Air (No other type of gas or liquid)
Working pressure	0 to 290 psi (20 bar)
Negative pressure	-29.5 in Hg / -750 mm Hg (-750 Torr)
Working temperature	-20°C to +80°C (-4°F to +176°F)
Application tube	Polyurethane and nylon

New



3700

MPL
SWIVEL MALE ELBOW

PART NUMBER	TUBE OD	THREAD	PRICE EACH	
			1 - 9	10 +
CDMPL04-M5	4 mm	M5 x 0.8	£2.45	£2.16
CDMPL04-M6	4 mm	M6 x 1.0	£2.45	£2.16
CDMPL04-01	4 mm	1/8" BSPT	£2.07	£1.83
CDMPL04-02	4 mm	1/4" BSPT	£2.22	£1.95
CDMPL04-03	4 mm	3/8" BSPT	£2.70	£2.38
CDMPL06-M5	6 mm	M5 x 0.8	£2.49	£2.20
CDMPL06-M6	6 mm	M6 x 1.0	£2.50	£2.20
CDMPL06-01	6 mm	1/8" BSPT	£2.11	£1.87
CDMPL06-02	6 mm	1/4" BSPT	£2.27	£2.00
CDMPL06-03	6 mm	3/8" BSPT	£2.66	£2.35
CDMPL08-01	8 mm	1/8" BSPT	£2.50	£2.21
CDMPL08-02	8 mm	1/4" BSPT	£2.64	£2.33
CDMPL08-03	8 mm	3/8" BSPT	£2.70	£2.39
CDMPL08-04	8 mm	1/2" BSPT	£4.01	£3.54
CDMPL10-02	10 mm	1/4" BSPT	£3.42	£3.02
CDMPL10-03	10 mm	3/8" BSPT	£3.43	£3.03
CDMPL10-04	10 mm	1/2" BSPT	£4.12	£3.63
CDMPL12-02	12 mm	1/4" BSPT	£4.12	£3.64
CDMPL12-03	12 mm	3/8" BSPT	£4.26	£3.76
CDMPL12-04	12 mm	1/2" BSPT	£4.48	£3.95

New



3700

MPUC
STRAIGHT UNION

PART NUMBER	TUBE OD	TUBE OD	PRICE EACH	
			1 - 9	10 +
CDMPUC04	4 mm	4 mm	£1.79	£1.58
CDMPUC06	6 mm	6 mm	£1.97	£1.74
CDMPUC08	8 mm	8 mm	£2.06	£1.82
CDMPUC10	10 mm	10 mm	£2.32	£2.05
CDMPUC12	12 mm	12 mm	£3.13	£2.76

New



3700

MPUL
UNION ELBOW

PART NUMBER	TUBE OD	TUBE OD	PRICE EACH	
			1 - 9	10 +
CDMPUL04	4 mm	4 mm	£1.69	£1.49
CDMPUL06	6 mm	6 mm	£1.97	£1.74
CDMPUL08	8 mm	8 mm	£2.06	£1.82
CDMPUL10	10 mm	10 mm	£2.32	£2.05
CDMPUL12	12 mm	12 mm	£3.13	£2.76

New



3700

MPT
SWIVEL BRANCH TEE

PART NUMBER	TUBE OD	THREAD	PRICE EACH	
			1 - 9	10 +
CDMPPT04-01	4 mm	1/8" BSPT	£2.90	£2.56
CDMPPT04-02	4 mm	1/4" BSPT	£3.04	£2.68
CDMPPT04-03	4 mm	3/8" BSPT	£3.78	£3.33
CDMPPT06-01	6 mm	1/8" BSPT	£3.13	£2.76
CDMPPT06-02	6 mm	1/4" BSPT	£3.29	£2.90
CDMPPT06-03	6 mm	3/8" BSPT	£3.84	£3.38
CDMPPT08-01	8 mm	1/8" BSPT	£3.62	£3.19
CDMPPT08-02	8 mm	1/4" BSPT	£3.71	£3.27
CDMPPT08-03	8 mm	3/8" BSPT	£3.89	£3.43
CDMPPT08-04	8 mm	1/2" BSPT	£5.13	£4.53
CDMPPT10-01	10 mm	1/8" BSPT	£4.47	£3.94
CDMPPT10-02	10 mm	1/4" BSPT	£4.56	£4.02
CDMPPT10-03	10 mm	3/8" BSPT	£4.80	£4.23
CDMPPT12-02	12 mm	1/4" BSPT	£5.26	£4.64
CDMPPT12-03	12 mm	3/8" BSPT	£5.39	£4.75
CDMPPT12-04	12 mm	1/2" BSPT	£5.63	£4.96

New



3700

MPUT
UNION TEE

PART NUMBER	TUBE OD	TUBE OD	PRICE EACH	
			1 - 9	10 +
CDMPUT04	4 mm	4 mm	£3.04	£2.68
CDMPUT06	6 mm	6 mm	£3.04	£2.68
CDMPUT08	8 mm	8 mm	£3.13	£2.76
CDMPUT10	10 mm	10 mm	£3.31	£2.92
CDMPUT12	12 mm	12 mm	£4.65	£4.10

ONE TOUCH 20 BAR HIGH PRESSURE - WHITE

FEATURES

- Smaller fittings, featuring wider working pressure and temperature ranges
- One touch, push-to-connect configuration allows instant tubing connection
- Main body of PL and PT types is a rotating structure for efficient piping
- The section has an O-ring or Teflon coating

APPLICATIONS

- One touch type pipe connection tool for air pressure piping
- Various uses depending on the user's environment

SPECIFICATIONS

Fluid type	Air (No other type of gas or liquid)
Working pressure	0 to 290 psi (20 bar)
Negative pressure	-29.5 in Hg / -750 mm Hg (-750 Torr)
Working temperature	-20°C to +80°C (-4°F to +176°F)
Application tube	Polyurethane and nylon

New



3700

MPL
SWIVEL MALE ELBOW

PART NUMBER	TUBE OD	THREAD	PRICE EACH	
			1 - 9	10 +
CDMPL04-M5W	4 mm	M5 x 0.8	£2.45	£2.16
CDMPL04-M6W	4 mm	M6 x 1.0	£2.45	£2.16
CDMPL04-01W	4 mm	1/8" BSPT	£2.07	£1.83
CDMPL04-02W	4 mm	1/4" BSPT	£2.22	£1.95
CDMPL04-03W	4 mm	3/8" BSPT	£2.70	£2.38
CDMPL06-M5W	6 mm	M5 x 0.8	£2.49	£2.20
CDMPL06-M6W	6 mm	M6 x 1.0	£2.50	£2.20
CDMPL06-01W	6 mm	1/8" BSPT	£2.11	£1.87
CDMPL06-02W	6 mm	1/4" BSPT	£2.27	£2.00
CDMPL06-03W	6 mm	3/8" BSPT	£2.66	£2.35
CDMPL08-01W	8 mm	1/8" BSPT	£2.50	£2.21
CDMPL08-02W	8 mm	1/4" BSPT	£2.64	£2.33
CDMPL08-03W	8 mm	3/8" BSPT	£2.70	£2.39
CDMPL08-04W	8 mm	1/2" BSPT	£4.01	£3.54
CDMPL10-02W	10 mm	1/4" BSPT	£3.42	£3.02
CDMPL10-03W	10 mm	3/8" BSPT	£3.43	£3.03
CDMPL10-04W	10 mm	1/2" BSPT	£4.12	£3.63
CDMPL12-02W	12 mm	1/4" BSPT	£4.12	£3.64
CDMPL12-03W	12 mm	3/8" BSPT	£4.26	£3.76
CDMPL12-04W	12 mm	1/2" BSPT	£4.48	£3.95

New



3700

MPUC
STRAIGHT UNION

PART NUMBER	TUBE OD	TUBE OD	PRICE EACH	
			1 - 9	10 +
CDMPUC04W	4 mm	4 mm	£1.79	£1.58
CDMPUC06W	6 mm	6 mm	£1.97	£1.74
CDMPUC08W	8 mm	8 mm	£2.06	£1.82
CDMPUC10W	10 mm	10 mm	£2.32	£2.05
CDMPUC12W	12 mm	12 mm	£3.13	£2.76

Eleven

New



3700

MPUL
UNION ELBOW

PART NUMBER	TUBE OD	TUBE OD	PRICE EACH	
			1 - 9	10 +
CDMPUL04W	4 mm	4 mm	£1.69	£1.49
CDMPUL06W	6 mm	6 mm	£1.97	£1.74
CDMPUL08W	8 mm	8 mm	£2.06	£1.82
CDMPUL10W	10 mm	10 mm	£2.32	£2.05
CDMPUL12W	12 mm	12 mm	£3.13	£2.76

New



3700

MPT
SWIVEL BRANCH TEE

PART NUMBER	TUBE OD	THREAD	PRICE EACH	
			1 - 9	10 +
CDMPT04-01W	4 mm	1/8" BSPT	£2.90	£2.56
CDMPT04-02W	4 mm	1/4" BSPT	£3.04	£2.68
CDMPT04-03W	4 mm	3/8" BSPT	£3.78	£3.33
CDMPT06-01W	6 mm	1/8" BSPT	£3.13	£2.76
CDMPT06-02W	6 mm	1/4" BSPT	£3.29	£2.90
CDMPT06-03W	6 mm	3/8" BSPT	£3.84	£3.38
CDMPT08-01W	8 mm	1/8" BSPT	£3.62	£3.19
CDMPT08-02W	8 mm	1/4" BSPT	£3.71	£3.27
CDMPT08-03W	8 mm	3/8" BSPT	£3.89	£3.43
CDMPT08-04W	8 mm	1/2" BSPT	£5.13	£4.53
CDMPT10-01W	10 mm	1/8" BSPT	£4.47	£3.94
CDMPT10-02W	10 mm	1/4" BSPT	£4.56	£4.02
CDMPT10-03W	10 mm	3/8" BSPT	£4.80	£4.23
CDMPT12-02W	12 mm	1/4" BSPT	£5.26	£4.64
CDMPT12-03W	12 mm	3/8" BSPT	£5.39	£4.75
CDMPT12-04W	12 mm	1/2" BSPT	£5.63	£4.96

New



3700

MPUT
UNION TEE

PART NUMBER	TUBE OD	TUBE OD	PRICE EACH	
			1 - 9	10 +
CDMPUT04W	4 mm	4 mm	£3.04	£2.68
CDMPUT06W	6 mm	6 mm	£3.04	£2.68
CDMPUT08W	8 mm	8 mm	£3.13	£2.76
CDMPUT10W	10 mm	10 mm	£3.31	£2.92
CDMPUT12W	12 mm	12 mm	£4.65	£4.10

FEATURES

- One touch, push-to-connect configuration allows instant tubing connection
- PC type has internal / external hexagonal shapes for efficient piping in limited spaces
- Main body of PL and PT types is a rotating structure for efficient piping
- The section has an O-ring or Teflon coating

APPLICATIONS

- One touch type pipe connection tool for air pressure piping
- Various uses depending on the user's environment

SPECIFICATIONS

Fluid type	Air (No other type of gas or liquid)
Working pressure	0 to 150 psi (10.2 bar)
Negative pressure	-29.5 in Hg / -750 mm Hg (-750 Torr)
Working temperature	0°C to +60°C (+32°F to +140°F)
Application tube	Polyurethane and nylon

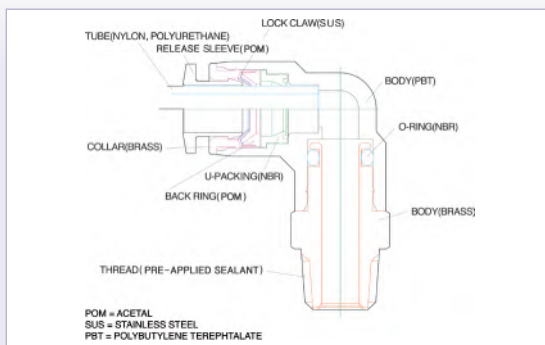

TUBE TO THREAD



PC
MALE STRAIGHT

3700

PART NUMBER	TUBE OD	THREAD	PRICE EACH	
			1 - 9	10 +
CDPC04M5N	4 mm	M5 x 0.8	£1.95	£1.75
CDPC04M6N	4 mm	M6 x 1.0	£1.95	£1.75
CDPC0401N	4 mm	1/8" BSPT	£1.48	£1.33
CDPC0402N	4 mm	1/4" BSPT	£1.50	£1.35
CDPC0403N	4 mm	3/8" BSPT	£2.05	£1.84
CDPC06M5N	6 mm	M5 x 0.8	£2.14	£1.91
CDPC06M6N	6 mm	M6 x 1.0	£2.14	£1.91
CDPC0601N	6 mm	1/8" BSPT	£1.60	£1.43
CDPC0602N	6 mm	1/4" BSPT	£1.69	£1.51
CDPC0603N	6 mm	3/8" BSPT	£2.12	£1.89
CDPC0604N	6 mm	1/2" BSPT	£2.75	£2.46
CDPC0801N	8 mm	1/8" BSPT	£1.92	£1.72
CDPC0802N	8 mm	1/4" BSPT	£1.95	£1.75
CDPC0803N	8 mm	3/8" BSPT	£2.18	£1.94
CDPC0804N	8 mm	1/2" BSPT	£3.23	£2.89
CDPC1001N	10 mm	1/8" BSPT	£2.33	£2.10
CDPC1002N	10 mm	1/4" BSPT	£2.29	£2.04
CDPC1003N	10 mm	3/8" BSPT	£2.30	£2.06
CDPC1004N	10 mm	1/2" BSPT	£2.86	£2.56
CDPC1201N	12 mm	1/8" BSPT	£2.57	£2.30
CDPC1202N	12 mm	1/4" BSPT	£2.89	£2.57
CDPC1203N	12 mm	3/8" BSPT	£2.98	£2.66
CDPC1204N	12 mm	1/2" BSPT	£3.34	£2.99
CDPC1403N	14 mm	3/8" BSPT	£5.60	£5.01
CDPC1404N	14 mm	1/2" BSPT	£5.65	£5.05
CDPC1603N	16 mm	3/8" BSPT	£8.88	£7.93
CDPC1604N	16 mm	1/2" BSPT	£8.90	£7.95



PC-G
MALE STRAIGHT

3700

PART NUMBER	TUBE OD	THREAD	PRICE EACH	
			1 - 9	10 +
CDPC04G01	4 mm	1/8" BSPP	£1.48	£1.33
CDPC04G02	4 mm	1/4" BSPP	£1.50	£1.35
CDPC04G03	4 mm	3/8" BSPP	£2.05	£1.84
CDPC06G01	6 mm	1/8" BSPP	£1.60	£1.43
CDPC06G02	6 mm	1/4" BSPP	£1.69	£1.51
CDPC06G03	6 mm	3/8" BSPP	£2.12	£1.89
CDPC08G01	8 mm	1/8" BSPP	£1.92	£1.72
CDPC08G02	8 mm	1/4" BSPP	£1.95	£1.75
CDPC08G03	8 mm	3/8" BSPP	£2.18	£1.94
CDPC08G04	8 mm	1/2" BSPP	£3.23	£2.89
CDPC10G01	10 mm	1/8" BSPP	£2.33	£2.10
CDPC10G02	10 mm	1/4" BSPP	£2.29	£2.04
CDPC10G03	10 mm	3/8" BSPP	£2.30	£2.06
CDPC10G04	10 mm	1/2" BSPP	£2.86	£2.56
CDPC12G02	12 mm	1/4" BSPP	£2.89	£2.57
CDPC12G03	12 mm	3/8" BSPP	£2.98	£2.66
CDPC12G04	12 mm	1/2" BSPP	£3.34	£2.99
CDPC14G03	14 mm	3/8" BSPP	£5.60	£5.01
CDPC14G04	14 mm	1/2" BSPP	£5.65	£5.05
CDPC16G03	16 mm	3/8" BSPP	£8.88	£7.93
CDPC16G04	16 mm	1/2" BSPP	£8.90	£7.95

Eleven

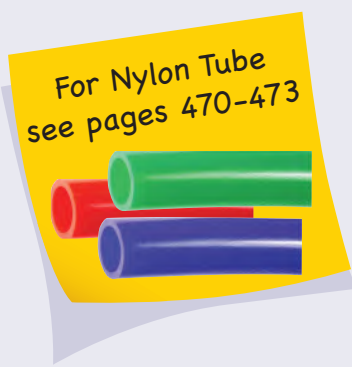

TUBE TO THREAD



POC
MALE STRAIGHT ROUND

3700

PART NUMBER	TUBE OD	THREAD	PRICE EACH	
			1 - 9	10 +
CDPOC04M5N	4 mm	M5 x 0.8	£2.11	£1.89
CDPOC04M6N	4 mm	M6 x 1.0	£2.33	£2.10
CDPOC0401N	4 mm	1/8" BSPT	£1.77	£1.59
CDPOC0402N	4 mm	1/4" BSPT	£1.79	£1.61
CDPOC0403N	4 mm	3/8" BSPT	£2.30	£2.06
CDPOC06M5N	6 mm	M5 x 0.8	£2.55	£2.28
CDPOC06M6N	6 mm	M6 x 1.0	£2.55	£2.28
CDPOC0601N	6 mm	1/8" BSPT	£1.92	£1.72
CDPOC0602N	6 mm	1/4" BSPT	£2.01	£1.80
CDPOC0603N	6 mm	3/8" BSPT	£2.53	£2.26
CDPOC0801N	8 mm	1/8" BSPT	£2.29	£2.05
CDPOC0802N	8 mm	1/4" BSPT	£2.33	£2.10
CDPOC0803N	8 mm	3/8" BSPT	£2.59	£2.32
CDPOC0804N	8 mm	1/2" BSPT	£3.86	£3.46
CDPOC1001N	10 mm	1/8" BSPT	£2.80	£2.50
CDPOC1002N	10 mm	1/4" BSPT	£2.74	£2.45
CDPOC1003N	10 mm	3/8" BSPT	£2.76	£2.47
CDPOC1004N	10 mm	1/2" BSPT	£3.44	£3.07
CDPOC1201N	12 mm	1/8" BSPT	£3.61	£3.23
CDPOC1202N	12 mm	1/4" BSPT	£3.45	£3.08
CDPOC1203N	12 mm	3/8" BSPT	£3.56	£3.19
CDPOC1204N	12 mm	1/2" BSPT	£4.01	£3.58



PCF
FEMALE STRAIGHT

3700

PART NUMBER	TUBE OD	THREAD	PRICE EACH	
			1 - 9	10 +
CDPCF0401N	4 mm	1/8" BSPT	£2.21	£1.97
CDPCF0402N	4 mm	1/4" BSPT	£2.33	£2.10
CDPCF0403N	4 mm	3/8" BSPT	£2.83	£2.53
CDPCF0601N	6 mm	1/8" BSPT	£2.38	£2.13
CDPCF0602N	6 mm	1/4" BSPT	£2.57	£2.30
CDPCF0603N	6 mm	3/8" BSPT	£2.93	£2.62
CDPCF0801N	8 mm	1/8" BSPT	£3.08	£2.76
CDPCF0802N	8 mm	1/4" BSPT	£4.06	£3.63
CDPCF0803N	8 mm	3/8" BSPT	£4.07	£3.64
CDPCF0804N	8 mm	1/2" BSPT	£4.52	£4.04
CDPCF1001N	10 mm	1/8" BSPT	£3.41	£3.04
CDPCF1002N	10 mm	1/4" BSPT	£3.41	£3.04
CDPCF1003N	10 mm	3/8" BSPT	£4.30	£3.84
CDPCF1004N	10 mm	1/2" BSPT	£4.64	£4.14
CDPCF1202N	12 mm	1/4" BSPT	£4.58	£4.10
CDPCF1203N	12 mm	3/8" BSPT	£4.74	£4.24
CDPCF1204N	12 mm	1/2" BSPT	£5.59	£5.00



PCF-G
FEMALE STRAIGHT

3700

PART NUMBER	TUBE OD	THREAD	PRICE EACH	
			1 - 9	10 +
CDPCF04G01	4 mm	1/8" BSPP	£2.21	£1.97
CDPCF04G02	4 mm	1/4" BSPP	£2.33	£2.10
CDPCF04G03	4 mm	3/8" BSPP	£2.83	£2.53
CDPCF06G01	6 mm	1/8" BSPP	£2.38	£2.13
CDPCF06G02	6 mm	1/4" BSPP	£2.57	£2.30
CDPCF06G03	6 mm	3/8" BSPP	£2.93	£2.62
CDPCF08G01	8 mm	1/8" BSPP	£3.08	£2.76
CDPCF08G02	8 mm	1/4" BSPP	£4.06	£3.63
CDPCF08G03	8 mm	3/8" BSPP	£4.07	£3.64
CDPCF08G04	8 mm	1/2" BSPP	£4.52	£4.04
CDPCF10G01	10 mm	1/8" BSPP	£3.41	£3.04
CDPCF10G02	10 mm	1/4" BSPP	£3.41	£3.04
CDPCF10G03	10 mm	3/8" BSPP	£4.30	£3.84
CDPCF10G04	10 mm	1/2" BSPP	£4.64	£4.14
CDPCF12G02	12 mm	1/4" BSPP	£4.58	£4.10
CDPCF12G03	12 mm	3/8" BSPP	£4.74	£4.24
CDPCF12G04	12 mm	1/2" BSPP	£5.59	£5.00

METRIC TUBE TO TUBE



PUC
EQUAL STRAIGHT UNION

3700

PART NUMBER	TUBE OD	PRICE EACH	
		1 - 9	10 +
CDPUC04N	4 mm	£1.71	£1.52
CDPUC06N	6 mm	£1.88	£1.68
CDPUC08N	8 mm	£1.97	£1.76
CDPUC10N	10 mm	£2.22	£1.98
CDPUC12N	12 mm	£2.98	£2.67
CDPUC14N	14 mm	£3.32	£2.97
CDPUC16N	16 mm	£6.81	£6.09



PY
EQUAL UNION 'Y'

3700

PART NUMBER	TUBE OD	PRICE EACH	
		1 - 9	10 +
CDPY04N	4 mm	£3.55	£3.17
CDPY06N	6 mm	£3.55	£3.17
CDPY08N	8 mm	£3.55	£3.17
CDPY10N	10 mm	£3.94	£3.52
CDPY12N	12 mm	£4.90	£4.38
CDPY16N	16 mm	£10.31	£9.22



PUT
EQUAL UNION TEE

3700

PART NUMBER	TUBE OD	PRICE EACH	
		1 - 9	10 +
CDPUT04N	4 mm	£2.91	£2.59
CDPUT06N	6 mm	£2.91	£2.59
CDPUT08N	8 mm	£2.98	£2.67
CDPUT10N	10 mm	£3.16	£2.82
CDPUT12N	12 mm	£4.44	£3.97
CDPUT14N	14 mm	£5.10	£4.56
CDPUT16N	16 mm	£10.31	£9.22



PW
REDUCER 'Y'

3700

PART NUMBER	TUBE OD (A)	TUBE OD (B)	PRICE EACH	
			1 - 9	10 +
CDPW0604	6 mm	4 mm	£2.72	£2.43
CDPW0804	8 mm	4 mm	£2.84	£2.54
CDPW0806	8 mm	6 mm	£2.84	£2.54
CDPW1006	10 mm	6 mm	£3.28	£2.94
CDPW1008	10 mm	8 mm	£3.29	£2.95
CDPW1208	12 mm	8 mm	£4.38	£3.92
CDPW1210	12 mm	10 mm	£4.38	£3.92
CDPW1612	16 mm	12 mm	£11.34	£10.14



PUL
EQUAL UNION ELBOW

3700

PART NUMBER	TUBE OD	PRICE EACH	
		1 - 9	10 +
CDPUL04N	4 mm	£1.61	£1.44
CDPUL06N	6 mm	£1.88	£1.68
CDPUL08N	8 mm	£1.97	£1.76
CDPUL10N	10 mm	£2.22	£1.98
CDPUL12N	12 mm	£2.98	£2.67
CDPUL14N	14 mm	£3.38	£3.03
CDPUL16N	16 mm	£6.86	£6.13



PZA
UNION CROSS

3700

PART NUMBER	TUBE OD	TUBE OD	PRICE EACH	
			1 - 9	10 +
CDPZA04N	4 mm	4 mm	£4.22	£3.77
CDPZA06N	6 mm	6 mm	£4.71	£4.21
CDPZA08N	8 mm	8 mm	£4.83	£4.32
CDPZA10N	10 mm	10 mm	£5.55	£4.96
CDPZA12N	12 mm	12 mm	£5.88	£5.26



PGT
REDUCER TEE

3700

PART NUMBER	TUBE OD (A)	TUBE OD (B)	PRICE EACH	
			1 - 9	10 +
CDPGT0406N	4 mm	6 mm	£2.91	£2.59
CDPGT0604N	6 mm	4 mm	£2.91	£2.59
CDPGT0608N	6 mm	8 mm	£2.98	£2.67
CDPGT0806N	8 mm	6 mm	£2.98	£2.67
CDPGT0810N	8 mm	10 mm	£3.16	£2.82
CDPGT1006N	10 mm	6 mm	£3.10	£2.78
CDPGT1008N	10 mm	8 mm	£3.16	£2.82
CDPGT1012N	10 mm	12 mm	£4.44	£3.97
CDPGT1208N	12 mm	8 mm	£4.44	£3.97
CDPGT1210N	12 mm	10 mm	£4.44	£3.97
CDPGT1610N	16 mm	10 mm	£10.26	£9.17
CDPGT1612N	16 mm	12 mm	£10.31	£9.22



PG
REDUCER

3700

PART NUMBER	TUBE OD	TUBE OD	PRICE EACH	
			1 - 9	10 +
CDPG0604N	6 mm	4 mm	£1.90	£1.70
CDPG0804N	8 mm	4 mm	£2.07	£1.86
CDPG0806N	8 mm	6 mm	£2.07	£1.86
CDPG1006N	10 mm	6 mm	£2.74	£2.45
CDPG1008N	10 mm	8 mm	£2.74	£2.45
CDPG1208N	12 mm	8 mm	£2.86	£2.56
CDPG1210N	12 mm	10 mm	£2.86	£2.56
CDPG1412N	14 mm	12 mm	£2.93	£2.62
CDPG1612N	16 mm	12 mm	£5.10	£4.56

METRIC TUBE TO TUBE



PL - SWIVEL ROTATING MALE ELBOW

3700



PMM BULKHEAD UNION

3700

PART NUMBER	TUBE OD	THREAD	PRICE EACH	
			1 - 9	10 +
CDPL04M5N	4 mm	M5 x 0.8	£2.33	£2.10
CDPL04M6N	4 mm	M6 x 1.0	£2.33	£2.10
CDPL0401N	4 mm	1/8" BSPT	£1.97	£1.76
CDPL0402N	4 mm	1/4" BSPT	£2.12	£1.89
CDPL0403N	4 mm	3/8" BSPT	£2.57	£2.30
CDPL06M5N	6 mm	M5 x 0.8	£2.38	£2.13
CDPL06M6N	6 mm	M6 x 1.0	£2.38	£2.13
CDPL0601N	6 mm	1/8" BSPT	£2.01	£1.80
CDPL0602N	6 mm	1/4" BSPT	£2.16	£1.93
CDPL0603N	6 mm	3/8" BSPT	£2.54	£2.27
CDPL0604N	6 mm	1/2" BSPT	£3.30	£2.96
CDPL0801N	8 mm	1/8" BSPT	£2.39	£2.14
CDPL0802N	8 mm	1/4" BSPT	£2.52	£2.25
CDPL0803N	8 mm	3/8" BSPT	£2.58	£2.30
CDPL0804N	8 mm	1/2" BSPT	£3.82	£3.42
CDPL1001N	10 mm	1/8" BSPT	£3.23	£2.89
CDPL1002N	10 mm	1/4" BSPT	£3.27	£2.92
CDPL1003N	10 mm	3/8" BSPT	£3.27	£2.93
CDPL1004N	10 mm	1/2" BSPT	£3.93	£3.51
CDPL1201N	12 mm	1/8" BSPT	£3.77	£3.37
CDPL1202N	12 mm	1/4" BSPT	£3.94	£3.51
CDPL1203N	12 mm	3/8" BSPT	£4.06	£3.63
CDPL1204N	12 mm	1/2" BSPT	£4.28	£3.82
CDPL1403N	14 mm	3/8" BSPT	£6.36	£5.68
CDPL1404N	14 mm	1/2" BSPT	£6.85	£6.12
CDPL1603N	16 mm	3/8" BSPT	£9.16	£8.19
CDPL1604N	16 mm	1/2" BSPT	£9.61	£8.60

PART NUMBER	TUBE OD	TUBE OD	PRICE EACH	
			1 - 9	10 +
CDPMM04N	4 mm	4 mm	£3.19	£2.85
CDPMM06N	6 mm	6 mm	£4.01	£3.58
CDPMM08N	8 mm	8 mm	£4.83	£4.32
CDPMM10N	10 mm	10 mm	£6.89	£6.16
CDPMM12N	12 mm	12 mm	£9.41	£8.41
CDPMM16N	16 mm	16 mm	£15.72	£14.06



PMF FEMALE STRAIGHT BULKHEAD

3700

PART NUMBER	TUBE OD	THREAD	PRICE EACH	
			1 - 9	10 +
CDPMF0401N	4 mm	1/8" BSPT	£3.95	£3.53
CDPMF0402N	4 mm	1/4" BSPT	£4.29	£3.83
CDPMF0403N	4 mm	3/8" BSPT	£4.66	£4.18
CDPMF0601N	6 mm	1/8" BSPT	£4.16	£3.73
CDPMF0602N	6 mm	1/4" BSPT	£4.28	£3.82
CDPMF0603N	6 mm	3/8" BSPT	£4.61	£4.12
CDPMF0801N	8 mm	1/8" BSPT	£4.73	£4.23
CDPMF0802N	8 mm	1/4" BSPT	£4.99	£4.46
CDPMF0803N	8 mm	3/8" BSPT	£5.20	£4.65
CDPMF0804N	8 mm	1/2" BSPT	£5.86	£5.24
CDPMF1001N	10 mm	1/8" BSPT	£6.15	£5.50
CDPMF1002N	10 mm	1/4" BSPT	£6.34	£5.67
CDPMF1003N	10 mm	3/8" BSPT	£6.64	£5.93
CDPMF1004N	10 mm	1/2" BSPT	£7.27	£6.50
CDPMF1202N	12 mm	1/4" BSPT	£7.06	£6.32
CDPMF1203N	12 mm	3/8" BSPT	£7.48	£6.69
CDPMF1204N	12 mm	1/2" BSPT	£8.04	£7.19



PL-G - SWIVEL ROTATING MALE ELBOW

3700

PART NUMBER	TUBE OD	THREAD	PRICE EACH	
			1 - 9	10 +
CDPL04G01	4 mm	1/8" BSPP	£1.97	£1.76
CDPL04G02	4 mm	1/4" BSPP	£2.12	£1.89
CDPL04G03	4 mm	3/8" BSPP	£2.57	£2.30
CDPL06G01	6 mm	1/8" BSPP	£2.01	£1.80
CDPL06G02	6 mm	1/4" BSPP	£2.16	£1.93
CDPL06G03	6 mm	3/8" BSPP	£2.54	£2.27
CDPL08G01	8 mm	1/8" BSPP	£2.39	£2.14
CDPL08G02	8 mm	1/4" BSPP	£2.52	£2.25
CDPL08G03	8 mm	3/8" BSPP	£2.58	£2.30
CDPL08G04	8 mm	1/2" BSPP	£3.82	£3.42
CDPL10G01	10 mm	1/8" BSPP	£3.27	£2.92
CDPL10G02	10 mm	1/4" BSPP	£3.23	£2.89
CDPL10G03	10 mm	3/8" BSPP	£3.27	£2.93
CDPL10G04	10 mm	1/2" BSPP	£3.93	£3.51
CDPL12G02	12 mm	1/4" BSPP	£3.94	£3.51
CDPL12G03	12 mm	3/8" BSPP	£4.06	£3.63
CDPL12G04	12 mm	1/2" BSPP	£4.28	£3.82
CDPL14G03	14 mm	3/8" BSPP	£6.36	£5.68
CDPL14G04	14 mm	1/2" BSPP	£6.85	£6.12
CDPL16G03	16 mm	3/8" BSPP	£9.16	£8.19
CDPL16G04	16 mm	1/2" BSPP	£9.61	£8.60



PMF-G FEMALE STRAIGHT BULKHEAD

3700

PART NUMBER	TUBE OD	THREAD	PRICE EACH	
			1 - 9	10 +
CDPMF04G01	4 mm	1/8" BSPP	£3.95	£3.53
CDPMF04G02	4 mm	1/4" BSPP	£4.29	£3.83
CDPMF04G03	4 mm	3/8" BSPP	£4.66	£4.18
CDPMF06G01	6 mm	1/8" BSPP	£4.16	£3.73
CDPMF06G02	6 mm	1/4" BSPP	£4.28	£3.82
CDPMF06G03	6 mm	3/8" BSPP	£4.61	£4.12
CDPMF08G01	8 mm	1/8" BSPP	£4.73	£4.23
CDPMF08G02	8 mm	1/4" BSPP	£4.99	£4.46
CDPMF08G03	8 mm	3/8" BSPP	£5.20	£4.65
CDPMF10G02	10 mm	1/4" BSPP	£6.34	£5.67
CDPMF10G03	10 mm	3/8" BSPP	£6.64	£5.93
CDPMF10G04	10 mm	1/2" BSPP	£7.27	£6.50
CDPMF12G02	12 mm	1/4" BSPP	£7.06	£6.32
CDPMF12G03	12 mm	3/8" BSPP	£7.48	£6.69
CDPMF12G04	12 mm	1/2" BSPP	£8.04	£7.19

TUBE TO THREAD

PPF CAP



3700

PART NUMBER	TUBE OD	PRICE EACH	
		1 - 9	10 +
CDPPF04N	4 mm	£1.29	£1.16
CDPPF06N	6 mm	£1.43	£1.27
CDPPF08N	8 mm	£1.55	£1.39
CDPPF10N	10 mm	£1.88	£1.67
CDPPF12N	12 mm	£2.05	£1.84
CDPPF16N	16 mm	£4.05	£3.62

PT – SWIVEL ROTATING MALE BRANCH TEE



3700

PART NUMBER	TUBE OD	THREAD	PRICE EACH	
			1 - 9	10 +
CDPT04M5N	4 mm	M5 x 0.8	£3.10	£2.78
CDPT04M6N	4 mm	M6 x 1.0	£3.10	£2.77
CDPT0401N	4 mm	1/8" BSPT	£2.76	£2.47
CDPT0402N	4 mm	1/4" BSPT	£2.90	£2.58
CDPT0403N	4 mm	3/8" BSPT	£3.60	£3.22
CDPT06M5N	6 mm	M5 x 0.8	£3.43	£3.06
CDPT06M6N	6 mm	M6 x 1.0	£3.43	£3.06
CDPT0601N	6 mm	1/8" BSPT	£2.98	£2.67
CDPT0602N	6 mm	1/4" BSPT	£3.14	£2.80
CDPT0603N	6 mm	3/8" BSPT	£3.66	£3.27
CDPT0604N	6 mm	1/2" BSPT	£4.48	£4.01
CDPT0801N	8 mm	1/8" BSPT	£3.45	£3.08
CDPT0802N	8 mm	1/4" BSPT	£3.53	£3.16
CDPT0803N	8 mm	3/8" BSPT	£3.71	£3.32
CDPT0804N	8 mm	1/2" BSPT	£4.89	£4.37
CDPT1001N	10 mm	1/8" BSPT	£4.26	£3.81
CDPT1002N	10 mm	1/4" BSPT	£4.34	£3.88
CDPT1003N	10 mm	3/8" BSPT	£4.58	£4.09
CDPT1004N	10 mm	1/2" BSPT	£5.04	£4.51
CDPT1201N	12 mm	1/8" BSPT	£4.85	£4.34
CDPT1202N	12 mm	1/4" BSPT	£5.02	£4.49
CDPT1203N	12 mm	3/8" BSPT	£5.14	£4.59
CDPT1204N	12 mm	1/2" BSPT	£5.36	£4.80
CDPT1603N	16 mm	3/8" BSPT	£13.10	£11.70
CDPT1604N	16 mm	1/2" BSPT	£13.58	£12.13

PLF – SWIVEL ROTATING FEMALE ELBOW



3700

PART NUMBER	TUBE OD	THREAD	PRICE EACH	
			1 - 9	10 +
CDPLF04M5N	4 mm	M5 x 0.8	£2.56	£2.28
CDPLF04M6N	4 mm	M6 x 1.0	£2.56	£2.28
CDPLF0401N	4 mm	1/8" BSPT	£2.17	£1.94
CDPLF06M5N	6 mm	M5 x 0.8	£2.59	£2.32
CDPLF06M6N	6 mm	M6 x 1.0	£2.59	£2.32
CDPLF0601N	6 mm	1/8" BSPT	£2.21	£1.97
CDPLF0602N	6 mm	1/4" BSPT	£2.37	£2.12
CDPLF0603N	6 mm	3/8" BSPT	£2.78	£2.48
CDPLF0801N	8 mm	1/8" BSPT	£2.62	£2.33
CDPLF0802N	8 mm	1/4" BSPT	£2.76	£2.47
CDPLF0803N	8 mm	3/8" BSPT	£2.82	£2.52
CDPLF0804N	8 mm	1/2" BSPT	£3.86	£3.46
CDPLF1002N	10 mm	1/4" BSPT	£3.53	£3.16
CDPLF1003N	10 mm	3/8" BSPT	£3.59	£3.21
CDPLF1004N	10 mm	1/2" BSPT	£4.30	£3.84
CDPLF1202N	12 mm	1/4" BSPT	£4.30	£3.84
CDPLF1203N	12 mm	3/8" BSPT	£4.46	£3.98
CDPLF1204N	12 mm	1/2" BSPT	£4.50	£4.02

PLF-G – SWIVEL ROTATING FEMALE ELBOW



3700

PART NUMBER	TUBE OD	THREAD	PRICE EACH	
			1 - 9	10 +
CDPLF04G01	4 mm	1/8" BSPP	£2.17	£1.94
CDPLF04G02	4 mm	1/4" BSPP	£2.31	£2.06
CDPLF06G01	6 mm	1/8" BSPP	£2.21	£1.97
CDPLF06G02	6 mm	1/4" BSPP	£2.37	£2.12
CDPLF06G03	6 mm	3/8" BSPP	£2.78	£2.48
CDPLF08G01	8 mm	1/8" BSPP	£2.62	£2.33
CDPLF08G02	8 mm	1/4" BSPP	£2.76	£2.47
CDPLF08G03	8 mm	3/8" BSPP	£2.82	£2.52
CDPLF08G04	8 mm	1/2" BSPP	£3.86	£3.46
CDPLF10G01	10 mm	1/8" BSPP	£3.36	£3.01
CDPLF10G02	10 mm	1/4" BSPP	£3.53	£3.16
CDPLF10G03	10 mm	3/8" BSPP	£3.59	£3.21
CDPLF10G04	10 mm	1/2" BSPP	£4.30	£3.84
CDPLF12G02	12 mm	1/4" BSPP	£4.30	£3.84
CDPLF12G03	12 mm	3/8" BSPP	£4.46	£3.98
CDPLF12G04	12 mm	1/2" BSPP	£4.50	£4.02

PT-G – SWIVEL ROTATING MALE BRANCH TEE



3700

PART NUMBER	TUBE OD	THREAD	PRICE EACH	
			1 - 9	10 +
CDPT04G01	4 mm	1/8" BSPP	£2.76	£2.47
CDPT04G02	4 mm	1/4" BSPP	£2.90	£2.58
CDPT04G03	4 mm	3/8" BSPP	£3.60	£3.22
CDPT06G01	6 mm	1/8" BSPP	£2.98	£2.67
CDPT06G02	6 mm	1/4" BSPP	£3.14	£2.80
CDPT06G03	6 mm	3/8" BSPP	£3.66	£3.27
CDPT08G01	8 mm	1/8" BSPP	£3.45	£3.08
CDPT08G02	8 mm	1/4" BSPP	£3.53	£3.16
CDPT08G03	8 mm	3/8" BSPP	£3.71	£3.32
CDPT08G04	8 mm	1/2" BSPP	£4.89	£4.37
CDPT10G01	10 mm	1/8" BSPP	£4.26	£3.81
CDPT10G02	10 mm	1/4" BSPP	£4.34	£3.88
CDPT10G03	10 mm	3/8" BSPP	£4.58	£4.09
CDPT10G04	10 mm	1/2" BSPP	£5.04	£4.51
CDPT12G02	12 mm	1/4" BSPP	£5.02	£4.49
CDPT12G03	12 mm	3/8" BSPP	£5.14	£4.59
CDPT12G04	12 mm	1/2" BSPP	£5.36	£4.80
CDPT16G03	16 mm	3/8" BSPP	£13.10	£11.70
CDPT16G04	16 mm	1/2" BSPP	£13.58	£12.13

TUBE TO THREAD



PTF – SWIVEL ROTATING FEMALE BRANCH TEE

3700

PST – SWIVEL ROTATING MALE RUN TEE

3700

PART NUMBER	TUBE OD	THREAD	PRICE EACH	
			1 - 9	10 +
CDPTF04M5N	4 mm	M5 x 0.8	£3.57	£3.20
CDPTF04M6N	4 mm	M6 x 1.0	£3.57	£3.20
CDPTF0401N	4 mm	1/8" BSPT	£3.17	£2.83
CDPTF0402N	4 mm	1/4" BSPT	£3.33	£2.98
CDPTF06M5N	6 mm	M5 x 0.8	£3.94	£3.51
CDPTF06M6N	6 mm	M6 x 1.0	£3.94	£3.51
CDPTF0601N	6 mm	1/8" BSPT	£3.44	£3.07
CDPTF0602N	6 mm	1/4" BSPT	£3.60	£3.22
CDPTF0603N	6 mm	3/8" BSPT	£4.21	£3.76
CDPTF0801N	8 mm	1/8" BSPT	£3.97	£3.54
CDPTF0802N	8 mm	1/4" BSPT	£4.05	£3.62
CDPTF0803N	8 mm	3/8" BSPT	£4.27	£3.81
CDPTF1001N	10 mm	1/8" BSPT	£4.90	£4.38
CDPTF1002N	10 mm	1/4" BSPT	£5.00	£4.47
CDPTF1003N	10 mm	3/8" BSPT	£5.27	£4.71
CDPTF1004N	10 mm	1/2" BSPT	£5.80	£5.18
CDPTF1202N	12 mm	1/4" BSPT	£5.77	£5.16
CDPTF1203N	12 mm	3/8" BSPT	£5.91	£5.28
CDPTF1204N	12 mm	1/2" BSPT	£6.17	£5.52

PART NUMBER	TUBE OD	THREAD	PRICE EACH	
			1 - 9	10 +
CDPST04M5N	4 mm	M5 x 0.8	£2.63	£2.34
CDPST04M6N	4 mm	M6 x 1.0	£2.92	£2.60
CDPST0401N	4 mm	1/8" BSPT	£2.93	£2.62
CDPST0402N	4 mm	1/4" BSPT	£2.93	£2.62
CDPST0403N	4 mm	3/8" BSPT	£3.51	£3.14
CDPST06M5N	6 mm	M5 x 0.8	£2.93	£2.62
CDPST06M6N	6 mm	M6 x 1.0	£2.92	£2.60
CDPST0601N	6 mm	1/8" BSPT	£2.93	£2.62
CDPST0602N	6 mm	1/4" BSPT	£2.93	£2.62
CDPST0603N	6 mm	3/8" BSPT	£3.56	£3.19
CDPST0604N	6 mm	1/2" BSPT	£4.27	£3.81
CDPST0801N	8 mm	1/8" BSPT	£3.10	£2.77
CDPST0802N	8 mm	1/4" BSPT	£3.10	£2.77
CDPST0803N	8 mm	3/8" BSPT	£3.56	£3.19
CDPST0804N	8 mm	1/2" BSPT	£4.44	£3.97
CDPST1001N	10 mm	1/8" BSPT	£3.28	£2.93
CDPST1002N	10 mm	1/4" BSPT	£3.56	£3.19
CDPST1003N	10 mm	3/8" BSPT	£3.56	£3.19
CDPST1004N	10 mm	1/2" BSPT	£3.75	£3.35
CDPST1201N	12 mm	1/8" BSPT	£4.14	£3.71
CDPST1202N	12 mm	1/4" BSPT	£4.32	£3.86
CDPST1203N	12 mm	3/8" BSPT	£4.98	£4.45
CDPST1204N	12 mm	1/2" BSPT	£5.91	£5.29



PTF-G – SWIVEL ROTATING FEMALE BRANCH TEE

3700

PST-G – SWIVEL ROTATING MALE RUN TEE

3700

PART NUMBER	TUBE OD	THREAD	PRICE EACH	
			1 - 9	10 +
CDPTF04G01	4 mm	1/8" BSPP	£3.17	£2.83
CDPTF04G02	4 mm	1/4" BSPP	£3.33	£2.98
CDPTF06G01	6 mm	1/8" BSPP	£3.44	£3.07
CDPTF06G02	6 mm	1/4" BSPP	£3.60	£3.22
CDPTF06G03	6 mm	3/8" BSPP	£4.21	£3.76
CDPTF08G01	8 mm	1/8" BSPP	£3.97	£3.54
CDPTF08G02	8 mm	1/4" BSPP	£4.05	£3.62
CDPTF08G03	8 mm	3/8" BSPP	£4.27	£3.81
CDPTF08G04	8 mm	1/2" BSPP	£5.63	£5.03
CDPTF10G01	10 mm	1/8" BSPP	£4.90	£4.38
CDPTF10G02	10 mm	1/4" BSPP	£5.00	£4.47
CDPTF10G03	10 mm	3/8" BSPP	£5.27	£4.71
CDPTF10G04	10 mm	1/2" BSPP	£5.80	£5.18
CDPTF12G02	12 mm	1/4" BSPP	£5.77	£5.16
CDPTF12G03	12 mm	3/8" BSPP	£5.91	£5.28
CDPTF12G04	12 mm	1/2" BSPP	£5.77	£5.16

PART NUMBER	TUBE OD	THREAD	PRICE EACH	
			1 - 9	10 +
CDPST04G01	4 mm	1/8" BSPP	£2.93	£2.62
CDPST04G02	4 mm	1/4" BSPP	£2.93	£2.62
CDPST04G03	4 mm	3/8" BSPP	£3.51	£3.14
CDPST06G01	6 mm	1/8" BSPP	£2.93	£2.62
CDPST06G02	6 mm	1/4" BSPP	£2.93	£2.62
CDPST06G03	6 mm	3/8" BSPP	£3.56	£3.19
CDPST08G01	8 mm	1/8" BSPP	£3.10	£2.77
CDPST08G02	8 mm	1/4" BSPP	£3.10	£2.77
CDPST08G03	8 mm	3/8" BSPP	£3.56	£3.19
CDPST08G04	8 mm	1/2" BSPP	£4.44	£3.97
CDPST10G01	10 mm	1/8" BSPP	£3.28	£2.93
CDPST10G02	10 mm	1/4" BSPP	£3.56	£3.19
CDPST10G03	10 mm	3/8" BSPP	£3.56	£3.19
CDPST10G04	10 mm	1/2" BSPP	£3.75	£3.35
CDPST12G02	12 mm	1/4" BSPP	£4.32	£3.86
CDPST12G03	12 mm	3/8" BSPP	£4.98	£4.45
CDPST12G04	12 mm	1/2" BSPP	£5.91	£5.29

TUBE TO THREAD



PWT – SWIVEL ROTATING
MALE 'Y'

3700



PL
45° MALE ELBOW

3700

PART NUMBER	TUBE OD	THREAD	PRICE EACH	
			1 - 9	10 +
CDPWT04M5N	4 mm	M5 x 0.8	£3.64	£3.26
CDPWT04M6N	4 mm	M6 x 1.0	£3.64	£3.26
CDPWT0401N	4 mm	1/8" BSPT	£3.64	£3.26
CDPWT0402N	4 mm	1/4" BSPT	£3.64	£3.26
CDPWT0403N	4 mm	3/8" BSPT	£4.24	£3.78
CDPWT06M5N	6 mm	M5 x 0.8	£3.64	£3.26
CDPWT06M6N	6 mm	M6 x 1.0	£3.64	£3.26
CDPWT0601N	6 mm	1/8" BSPT	£3.64	£3.26
CDPWT0602N	6 mm	1/4" BSPT	£3.64	£3.26
CDPWT0603N	6 mm	3/8" BSPT	£4.25	£3.80
CDPWT0604N	6 mm	1/2" BSPT	£4.49	£4.01
CDPWT0801N	8 mm	1/4" BSPT	£3.81	£3.41
CDPWT0802N	8 mm	1/4" BSPT	£3.81	£3.41
CDPWT0803N	8 mm	3/8" BSPT	£4.25	£3.80
CDPWT0804N	8 mm	1/2" BSPT	£4.50	£4.02
CDPWT1001N	10 mm	1/8" BSPT	£4.39	£3.94
CDPWT1002N	10 mm	1/4" BSPT	£3.99	£3.56
CDPWT1003N	10 mm	3/8" BSPT	£4.25	£3.80
CDPWT1004N	10 mm	1/2" BSPT	£5.00	£4.47
CDPWT1201N	12 mm	1/8" BSPT	£5.27	£4.72
CDPWT1202N	12 mm	1/4" BSPT	£5.39	£4.82
CDPWT1203N	12 mm	3/8" BSPT	£7.16	£6.40
CDPWT1204N	12 mm	1/2" BSPT	£7.88	£7.05

PART NUMBER	OD	THREAD	PRICE EACH	
			1 - 9	10 +
CDPL4504M5N	4 mm	M5	£2.69	£2.41
CDPL4504M6N	4 mm	M6	£2.69	£2.41
CDPL450401N	4 mm	1/8" BSPT	£2.27	£2.03
CDPL450402N	4 mm	1/4" BSPT	£2.43	£2.18
CDPL450403N	4 mm	3/8" BSPT	£2.96	£2.65
CDPL4506M5N	6 mm	M5	£2.74	£2.45
CDPL4506M6N	6 mm	M6	£2.74	£2.45
CDPL450601N	6 mm	1/8" BSPT	£2.32	£2.07
CDPL450602N	6 mm	1/4" BSPT	£2.49	£2.23
CDPL450603N	6 mm	3/8" BSPT	£2.92	£2.60
CDPL450604N	6 mm	1/2" BSPT	£3.80	£3.40
CDPL450801N	8 mm	1/8" BSPT	£2.75	£2.46
CDPL450802N	8 mm	1/4" BSPT	£2.90	£2.59
CDPL450803N	8 mm	3/8" BSPT	£2.97	£2.66
CDPL450804N	8 mm	1/2" BSPT	£4.39	£3.94
CDPL451001N	10 mm	1/8" BSPT	£3.71	£3.31
CDPL451002N	10 mm	1/4" BSPT	£3.76	£3.35
CDPL451003N	10 mm	3/8" BSPT	£3.77	£3.36
CDPL451004N	10 mm	1/2" BSPT	£4.52	£4.04
CDPL451201N	12 mm	1/8" BSPT	£4.34	£3.88
CDPL451202N	12 mm	1/4" BSPT	£4.52	£4.04
CDPL451203N	12 mm	3/8" BSPT	£4.67	£4.18
CDPL451204N	12 mm	1/2" BSPT	£4.92	£4.40



PWT-G – SWIVEL ROTATING
MALE 'Y'

3700



PL-G
45° MALE ELBOW

3700

PART NUMBER	TUBE OD	THREAD	PRICE EACH	
			1 - 9	10 +
CDPWT04G01	4 mm	1/8" BSPP	£3.64	£3.26
CDPWT04G02	4 mm	1/4" BSPP	£3.64	£3.26
CDPWT04G03	4 mm	3/8" BSPP	£4.24	£3.78
CDPWT06G01	6 mm	1/8" BSPP	£3.64	£3.26
CDPWT06G02	6 mm	1/4" BSPP	£3.64	£3.26
CDPWT06G03	6 mm	3/8" BSPP	£4.25	£3.80
CDPWT08G01	8 mm	1/8" BSPP	£3.81	£3.41
CDPWT08G02	8 mm	1/4" BSPP	£3.81	£3.41
CDPWT08G03	8 mm	3/8" BSPP	£4.25	£3.80
CDPWT08G04	8 mm	1/2" BSPP	£4.50	£4.02
CDPWT10G01	10 mm	1/8" BSPP	£4.39	£3.94
CDPWT10G02	10 mm	1/4" BSPP	£3.99	£3.56
CDPWT10G03	10 mm	3/8" BSPP	£4.25	£3.80
CDPWT10G04	10 mm	1/2" BSPP	£5.00	£4.47
CDPWT12G02	12 mm	1/4" BSPP	£5.39	£4.82
CDPWT12G03	12 mm	3/8" BSPP	£7.16	£6.40
CDPWT12G04	12 mm	1/2" BSPP	£7.88	£7.05

PART NUMBER	OD	THREAD	PRICE EACH	
			1 - 9	10 +
CDPL4504G01	4 mm	1/8" BSPP	£2.27	£2.03
CDPL4504G02	4 mm	1/4" BSPP	£2.43	£2.18
CDPL4504G03	4 mm	3/8" BSPP	£2.96	£2.65
CDPL4506G01	6 mm	1/8" BSPP	£2.32	£2.07
CDPL4506G02	6 mm	1/4" BSPP	£2.49	£2.23
CDPL4506G03	6 mm	3/8" BSPP	£2.92	£2.60
CDPL4506G04	6 mm	1/2" BSPP	£3.80	£3.40
CDPL4508G01	8 mm	1/8" BSPP	£2.75	£2.46
CDPL4508G02	8 mm	1/4" BSPP	£2.90	£2.59
CDPL4508G03	8 mm	3/8" BSPP	£2.97	£2.66
CDPL4508G04	8 mm	1/2" BSPP	£4.39	£3.94
CDPL4510G01	10 mm	1/8" BSPP	£3.76	£3.35
CDPL4510G02	10 mm	1/4" BSPP	£3.71	£3.31
CDPL4510G03	10 mm	3/8" BSPP	£3.77	£3.36
CDPL4510G04	10 mm	1/2" BSPP	£4.52	£4.04
CDPL4512G02	12 mm	1/4" BSPP	£4.52	£4.04
CDPL4512G03	12 mm	3/8" BSPP	£4.67	£4.18
CDPL4512G04	12 mm	1/2" BSPP	£4.92	£4.40

TUBE TO THREAD



**PLL – SWIVEL ROTATING
EXTENDED MALE ELBOW**

3700



**PLLP – SWIVEL ROTATING
EXTENDED MALE ELBOW**

3700

E11ven

PART NUMBER	TUBE OD	THREAD	PRICE EACH	
			1 - 9	10 +
CDPLL04M5N	4 mm	M5 x 0.8	£3.14	£2.80
CDPLL04M6N	4 mm	M6 x 1.0	£3.14	£2.80
CDPLL0401N	4 mm	1/8" BSPT	£2.98	£2.66
CDPLL0402N	4 mm	1/4" BSPT	£3.21	£2.88
CDPLL0403N	4 mm	3/8" BSPT	£3.95	£3.53
CDPLL06M5N	6 mm	M5 x 0.8	£3.25	£2.90
CDPLL06M6N	6 mm	M6 x 1.0	£3.25	£2.90
CDPLL0601N	6 mm	1/8" BSPT	£3.28	£2.94
CDPLL0602N	6 mm	1/4" BSPT	£3.46	£3.09
CDPLL0603N	6 mm	3/8" BSPT	£4.10	£3.67
CDPLL0604N	6 mm	1/2" BSPT	£5.03	£4.50
CDPLL0801N	8 mm	1/4" BSPT	£3.56	£3.19
CDPLL0802N	8 mm	1/4" BSPT	£3.71	£3.31
CDPLL0803N	8 mm	3/8" BSPT	£4.48	£4.01
CDPLL0804N	8 mm	1/2" BSPT	£5.51	£4.92
CDPLL1001N	10 mm	1/8" BSPT	£4.51	£4.03
CDPLL1002N	10 mm	1/4" BSPT	£4.61	£4.12
CDPLL1003N	10 mm	3/8" BSPT	£4.75	£4.25
CDPLL1004N	10 mm	1/2" BSPT	£6.53	£5.84
CDPLL1201N	12 mm	1/8" BSPT	£6.46	£5.78
CDPLL1202N	12 mm	1/4" BSPT	£6.66	£5.95
CDPLL1203N	12 mm	3/8" BSPT	£6.98	£6.23
CDPLL1204N	12 mm	1/2" BSPT	£7.26	£6.49

PART NUMBER	TUBE OD	THREAD	PRICE EACH	
			1 - 9	10 +
CDPLL04M5N	4 mm	M5 x 0.8	£2.55	£2.28
CDPLL04M6N	4 mm	M6 x 1.0	£2.57	£2.30
CDPLL0401N	4 mm	1/8" BSPT	£2.01	£1.80
CDPLL0402N	4 mm	1/4" BSPT	£2.66	£2.38
CDPLL0403N	4 mm	3/8" BSPT	£3.20	£2.85
CDPLL06M5N	6 mm	M5 x 0.8	£2.80	£2.51
CDPLL06M6N	6 mm	M6 x 1.0	£2.84	£2.54
CDPLL0601N	6 mm	1/8" BSPT	£2.33	£2.10
CDPLL0602N	6 mm	1/4" BSPT	£2.81	£2.51
CDPLL0603N	6 mm	3/8" BSPT	£3.48	£3.11
CDPLL0604N	6 mm	1/2" BSPT	£4.73	£4.23
CDPLL0801N	8 mm	1/8" BSPT	£2.57	£2.30
CDPLL0802N	8 mm	1/4" BSPT	£2.92	£2.60
CDPLL0803N	8 mm	3/8" BSPT	£3.56	£3.19
CDPLL0804N	8 mm	1/2" BSPT	£4.67	£4.19
CDPLL1001N	10 mm	1/8" BSPT	£3.34	£2.99
CDPLL1002N	10 mm	1/4" BSPT	£3.61	£3.23
CDPLL1003N	10 mm	3/8" BSPT	£3.71	£3.32
CDPLL1004N	10 mm	1/2" BSPT	£4.94	£4.41
CDPLL1201N	12 mm	1/8" BSPT	£4.23	£3.78
CDPLL1202N	12 mm	1/4" BSPT	£4.49	£4.01
CDPLL1203N	12 mm	3/8" BSPT	£4.46	£3.99
CDPLL1204N	12 mm	1/2" BSPT	£5.12	£4.58



**PLL-G – SWIVEL ROTATING
EXTENDED MALE ELBOW**

3700



**PLLP-G – SWIVEL ROTATING
EXTENDED MALE ELBOW**

3700

PART NUMBER	TUBE OD	THREAD	PRICE EACH	
			1 - 9	10 +
CDPLL04G01	4 mm	1/8" BSPP	£2.98	£2.66
CDPLL04G02	4 mm	1/4" BSPP	£3.21	£2.88
CDPLL04G03	4 mm	3/8" BSPP	£3.95	£3.53
CDPLL06G01	6 mm	1/8" BSPP	£3.28	£2.94
CDPLL06G02	6 mm	1/4" BSPP	£3.46	£3.09
CDPLL06G03	6 mm	3/8" BSPP	£4.10	£3.67
CDPLL08G01	8 mm	1/8" BSPP	£3.56	£3.19
CDPLL08G02	8 mm	1/4" BSPP	£3.71	£3.31
CDPLL08G03	8 mm	3/8" BSPP	£4.48	£4.01
CDPLL08G04	8 mm	1/2" BSPP	£5.51	£4.92
CDPLL10G01	10 mm	1/8" BSPP	£4.51	£4.03
CDPLL10G02	10 mm	1/4" BSPP	£4.61	£4.12
CDPLL10G03	10 mm	3/8" BSPP	£4.75	£4.25
CDPLL10G04	10 mm	1/2" BSPP	£6.53	£5.84
CDPLL12G02	12 mm	1/4" BSPP	£6.66	£5.95
CDPLL12G03	12 mm	3/8" BSPP	£6.98	£6.23
CDPLL12G04	12 mm	1/2" BSPP	£7.26	£6.49

PART NUMBER	TUBE OD	THREAD	PRICE EACH	
			1 - 9	10 +
CDPLL04G01	4 mm	1/8" BSPP	£2.01	£1.80
CDPLL04G02	4 mm	1/4" BSPP	£2.66	£2.38
CDPLL04G03	4 mm	3/8" BSPP	£3.20	£2.85
CDPLL06G01	6 mm	1/8" BSPP	£2.33	£2.10
CDPLL06G02	6 mm	1/4" BSPP	£2.81	£2.51
CDPLL06G03	6 mm	3/8" BSPP	£3.48	£3.11
CDPLL08G01	8 mm	1/8" BSPP	£2.57	£2.30
CDPLL08G02	8 mm	1/4" BSPP	£2.92	£2.60
CDPLL08G03	8 mm	3/8" BSPP	£3.56	£3.19
CDPLL08G04	8 mm	1/2" BSPP	£4.67	£4.19
CDPLL10G01	10 mm	1/8" BSPP	£3.34	£2.99
CDPLL10G02	10 mm	1/4" BSPP	£3.61	£3.23
CDPLL10G03	10 mm	3/8" BSPP	£3.71	£3.32
CDPLL10G04	10 mm	1/2" BSPP	£4.94	£4.41
CDPLL12G02	12 mm	1/4" BSPP	£4.49	£4.01
CDPLL12G03	12 mm	3/8" BSPP	£4.46	£3.99
CDPLL12G04	12 mm	1/2" BSPP	£5.12	£4.58

TUBE TO THREAD



PXT
MALE DOUBLE 'Y'

3700

PART NUMBER	TUBE OD	THREAD	PRICE EACH	
			1 - 9	10 +
CDPXT0401	4 mm	1/8" BSPT	£8.00	£7.15
CDPXT0402	4 mm	1/4" BSPT	£8.20	£7.33
CDPXT0601	6 mm	1/8" BSPT	£10.59	£9.47
CDPXT0602	6 mm	1/4" BSPT	£10.80	£9.65

PXT-G
MALE DOUBLE 'Y'

3700

PART NUMBER	TUBE OD	THREAD	PRICE EACH	
			1 - 9	10 +
CDPXT04G01	4 mm	1/8" BSPP	£8.00	£7.15
CDPXT04G02	4 mm	1/4" BSPP	£8.20	£7.33
CDPXT06G01	6 mm	1/8" BSPP	£10.59	£9.47
CDPXT06G02	6 mm	1/4" BSPP	£10.80	£9.65



PH - SWIVEL ROTATING
MALE BANJO

3700

PART NUMBER	TUBE OD	THREAD	PRICE EACH	
			1 - 9	10 +
CDPH04M5N	4 mm	M5 x 0.8	£2.93	£2.62
CDPH04M6N	4 mm	M6 x 1.0	£3.26	£2.92
CDPH0401N	4 mm	1/8" BSPT	£3.23	£2.89
CDPH0402N	4 mm	1/4" BSPT	£3.56	£3.19
CDPH06M5N	6 mm	M5 x 0.8	£3.79	£3.40
CDPH06M6N	6 mm	M6 x 1.0	£3.79	£3.40
CDPH0601N	6 mm	1/8" BSPT	£3.82	£3.42
CDPH0602N	6 mm	1/4" BSPT	£3.89	£3.49
CDPH0603N	6 mm	3/8" BSPT	£4.06	£3.63
CDPH0801N	8 mm	1/8" BSPT	£4.28	£3.82
CDPH0802N	8 mm	1/4" BSPT	£4.28	£3.83
CDPH0803N	8 mm	3/8" BSPT	£4.91	£4.39
CDPH0804N	8 mm	1/2" BSPT	£5.92	£5.30
CDPH1001N	10 mm	1/8" BSPT	£4.57	£4.08
CDPH1002N	10 mm	1/4" BSPT	£4.57	£4.08
CDPH1003N	10 mm	3/8" BSPT	£4.88	£4.36
CDPH1004N	10 mm	1/2" BSPT	£6.40	£5.72
CDPH1202N	12 mm	1/4" BSPT	£6.97	£6.23
CDPH1203N	12 mm	3/8" BSPT	£7.32	£6.54
CDPH1204N	12 mm	1/2" BSPT	£8.42	£7.52

PH-G - SWIVEL ROTATING
MALE BANJO

3700

PART NUMBER	TUBE OD	THREAD	PRICE EACH	
			1 - 9	10 +
CDPH04G01	4 mm	1/8" BSPP	£3.23	£2.89
CDPH04G02	4 mm	1/4" BSPP	£3.55	£3.18
CDPH06G01	6 mm	1/8" BSPP	£3.82	£3.42
CDPH06G02	6 mm	1/4" BSPP	£3.89	£3.49
CDPH06G03	6 mm	3/8" BSPP	£4.06	£3.63
CDPH08G01	8 mm	1/8" BSPP	£4.28	£3.82
CDPH08G02	8 mm	1/4" BSPP	£4.28	£3.83
CDPH08G03	8 mm	3/8" BSPP	£4.91	£4.39
CDPH08G04	8 mm	1/2" BSPP	£5.92	£5.30
CDPH10G02	10 mm	1/4" BSPP	£4.62	£4.13
CDPH10G03	10 mm	3/8" BSPP	£4.88	£4.36
CDPH10G04	10 mm	1/2" BSPP	£6.40	£5.72
CDPH12G03	12 mm	3/8" BSPP	£7.32	£6.54
CDPH12G04	12 mm	1/2" BSPP	£8.42	£7.52



PHF - SWIVEL ROTATING
FEMALE STACKING BANJO

3700

PART NUMBER	TUBE OD	THREAD	PRICE EACH	
			1 - 9	10 +
CDPHF04M5N	4 mm	M5 x 0.8	£3.58	£3.20
CDPHF04M6N	4 mm	M6 x 1.0	£3.58	£3.20
CDPHF0401N	4 mm	1/8" BSPT	£3.55	£3.17
CDPHF06M5N	6 mm	M5 x 0.8	£4.18	£3.74
CDPHF06M6N	6 mm	M6 x 1.0	£4.18	£3.74
CDPHF0601N	6 mm	1/8" BSPT	£4.20	£3.75
CDPHF0602N	6 mm	1/4" BSPT	£4.28	£3.83
CDPHF0801N	8 mm	1/8" BSPT	£4.70	£4.21
CDPHF0802N	8 mm	1/4" BSPT	£4.72	£4.22
CDPHF0803N	8 mm	3/8" BSPT	£5.40	£4.83
CDPHF0804N	8 mm	1/2" BSPT	£6.52	£5.83
CDPHF1002N	10 mm	1/4" BSPT	£5.09	£4.55
CDPHF1003N	10 mm	3/8" BSPT	£5.37	£4.80
CDPHF1004N	10 mm	1/2" BSPT	£7.05	£6.30
CDPHF1203N	12 mm	3/8" BSPT	£8.04	£7.19
CDPHF1204N	12 mm	1/2" BSPT	£9.26	£8.27

PHF-G
FEMALE STACKING BANJO

3700

PART NUMBER	TUBE OD	THREAD	PRICE EACH	
			1 - 9	10 +
CDPHF04G01	4 mm	1/8" BSPP	£4.22	£3.77
CDPHF04G02	4 mm	1/4" BSPP	£5.91	£5.28
CDPHF04G03	4 mm	3/8" BSPP	£8.09	£7.22
CDPHF04G04	4 mm	1/2" BSPP	£10.65	£9.52
CDPHF06G01	6 mm	1/8" BSPP	£4.33	£3.87
CDPHF06G02	6 mm	1/4" BSPP	£6.03	£5.38
CDPHF06G03	6 mm	3/8" BSPP	£8.20	£7.33
CDPHF06G04	6 mm	1/2" BSPP	£10.76	£9.62
CDPHF08G01	8 mm	1/8" BSPP	£4.47	£4.00
CDPHF08G02	8 mm	1/4" BSPP	£6.16	£5.51
CDPHF08G03	8 mm	3/8" BSPP	£8.34	£7.45
CDPHF08G04	8 mm	1/2" BSPP	£10.89	£9.74
CDPHF10G01	10 mm	1/8" BSPP	£4.73	£4.23
CDPHF10G02	10 mm	1/4" BSPP	£6.43	£5.75
CDPHF10G03	10 mm	3/8" BSPP	£8.60	£7.69
CDPHF10G04	10 mm	1/2" BSPP	£11.16	£9.98
CDPHF12G02	12 mm	1/4" BSPP	£6.85	£6.12
CDPHF12G03	12 mm	3/8" BSPP	£9.02	£8.06
CDPHF12G04	12 mm	1/2" BSPP	£11.58	£10.35

TUBE TO THREAD

PHL DOUBLE UNIVERSAL ELBOW



3700

PART NUMBER	TUBE OD	THREAD	PRICE EACH	
			1 - 9	10 +
CDPHL0401-2	4 mm	1/8" BSPT	£8.88	£7.94
CDPHL0402-2	4 mm	1/4" BSPT	£11.41	£10.21
CDPHL0403-2	4 mm	3/8" BSPT	£14.98	£13.39
CDPHL0404-2	4 mm	1/2" BSPT	£19.21	£17.18
CDPHL0601-2	6 mm	1/8" BSPT	£9.12	£8.16
CDPHL0602-2	6 mm	1/4" BSPT	£11.66	£10.43
CDPHL0603-2	6 mm	3/8" BSPT	£15.23	£13.62
CDPHL0604-2	6 mm	1/2" BSPT	£19.45	£17.38
CDPHL0801-2	8 mm	1/8" BSPT	£9.42	£8.42
CDPHL0802-2	8 mm	1/4" BSPT	£11.94	£10.69
CDPHL0803-2	8 mm	3/8" BSPT	£15.52	£13.87
CDPHL0804-2	8 mm	1/2" BSPT	£19.74	£17.65
CDPHL1001-2	10 mm	1/8" BSPT	£9.97	£8.92
CDPHL1002-2	10 mm	1/4" BSPT	£12.51	£11.17
CDPHL1003-2	10 mm	3/8" BSPT	£16.07	£14.37
CDPHL1004-2	10 mm	1/2" BSPT	£20.31	£18.15
CDPHL1202-2	12 mm	1/4" BSPT	£18.63	£16.66
CDPHL1203-2	12 mm	3/8" BSPT	£23.18	£20.71
CDPHL1204-2	12 mm	1/2" BSPT	£28.51	£25.48

PHL-G DOUBLE UNIVERSAL ELBOW



3700

PART NUMBER	TUBE OD	THREAD	PRICE EACH	
			1 - 9	10 +
CDPHL04G012	4 mm	1/8" BSPP	£8.88	£7.94
CDPHL04G022	4 mm	1/4" BSPP	£11.41	£10.21
CDPHL04G032	4 mm	3/8" BSPP	£14.98	£13.39
CDPHL04G042	4 mm	1/2" BSPP	£19.21	£17.18
CDPHL06G012	6 mm	1/8" BSPP	£9.12	£8.16
CDPHL06G022	6 mm	1/4" BSPP	£11.66	£10.43
CDPHL06G032	6 mm	3/8" BSPP	£15.23	£13.62
CDPHL06G042	6 mm	1/2" BSPP	£19.45	£17.38
CDPHL08G012	8 mm	1/8" BSPP	£9.42	£8.42
CDPHL08G022	8 mm	1/4" BSPP	£11.94	£10.69
CDPHL08G032	8 mm	3/8" BSPP	£15.52	£13.87
CDPHL08G042	8 mm	1/2" BSPP	£19.74	£17.65
CDPHL10G012	10 mm	1/8" BSPP	£9.97	£8.92
CDPHL10G022	10 mm	1/4" BSPP	£12.51	£11.17
CDPHL10G032	10 mm	3/8" BSPP	£16.07	£14.37
CDPHL10G042	10 mm	1/2" BSPP	£20.31	£18.15
CDPHL12G022	12 mm	1/4" BSPP	£18.63	£16.66
CDPHL12G032	12 mm	3/8" BSPP	£23.18	£20.71
CDPHL12G042	12 mm	1/2" BSPP	£28.51	£25.48

Elevan

PHL TRIPLE UNIVERSAL ELBOW



3700

PART NUMBER	TUBE OD	THREAD	PRICE EACH	
			1 - 9	10 +
CDPHL0401-3	4 mm	1/8" BSPT	£11.62	£10.39
CDPHL0402-3	4 mm	1/4" BSPT	£15.64	£13.97
CDPHL0403-3	4 mm	3/8" BSPT	£20.18	£18.04
CDPHL0404-3	4 mm	1/2" BSPT	£25.53	£22.82
CDPHL0601-3	6 mm	1/8" BSPT	£11.99	£10.72
CDPHL0602-3	6 mm	1/4" BSPT	£16.00	£14.30
CDPHL0603-3	6 mm	3/8" BSPT	£20.54	£18.37
CDPHL0604-3	6 mm	1/2" BSPT	£25.89	£23.14
CDPHL0801-3	8 mm	1/8" BSPT	£12.43	£11.11
CDPHL0802-3	8 mm	1/4" BSPT	£16.44	£14.69
CDPHL0803-3	8 mm	3/8" BSPT	£20.98	£18.76
CDPHL0804-3	8 mm	1/2" BSPT	£26.33	£23.54
CDPHL1001-3	10 mm	1/8" BSPT	£13.26	£11.86
CDPHL1002-3	10 mm	1/4" BSPT	£17.28	£15.44
CDPHL1003-3	10 mm	3/8" BSPT	£21.81	£19.50
CDPHL1004-3	10 mm	1/2" BSPT	£27.17	£24.29
CDPHL1202-3	12 mm	1/4" BSPT	£18.63	£16.66
CDPHL1203-3	12 mm	3/8" BSPT	£23.18	£20.71
CDPHL1204-3	12 mm	1/2" BSPT	£28.51	£25.48

PHL-G TRIPLE UNIVERSAL ELBOW



3700

PART NUMBER	TUBE OD	THREAD	PRICE EACH	
			1 - 9	10 +
CDPHL04G013	4 mm	1/8" BSPP	£11.62	£10.39
CDPHL04G023	4 mm	1/4" BSPP	£15.64	£13.97
CDPHL04G033	4 mm	3/8" BSPP	£20.18	£18.04
CDPHL04G043	4 mm	1/2" BSPP	£25.53	£22.82
CDPHL06G013	6 mm	1/8" BSPP	£11.99	£10.72
CDPHL06G023	6 mm	1/4" BSPP	£16.00	£14.30
CDPHL06G033	6 mm	3/8" BSPP	£20.54	£18.37
CDPHL06G043	6 mm	1/2" BSPP	£25.89	£23.14
CDPHL08G013	8 mm	1/8" BSPP	£12.43	£11.11
CDPHL08G023	8 mm	1/4" BSPP	£16.44	£14.69
CDPHL08G033	8 mm	3/8" BSPP	£20.98	£18.76
CDPHL08G043	8 mm	1/2" BSPP	£26.33	£23.54
CDPHL10G013	10 mm	1/8" BSPP	£13.26	£11.86
CDPHL10G023	10 mm	1/4" BSPP	£17.28	£15.44
CDPHL10G033	10 mm	3/8" BSPP	£21.81	£19.50
CDPHL10G043	10 mm	1/2" BSPP	£27.17	£24.29
CDPHL12G023	12 mm	1/4" BSPP	£18.63	£16.66
CDPHL12G033	12 mm	3/8" BSPP	£23.18	£20.71
CDPHL12G043	12 mm	1/2" BSPP	£28.51	£25.48

PKD MALE REDUCER TRIPLE BRANCH UNION



3700

PART NUMBER	TUBE OD (A)	TUBE OD (B)	THREAD	PRICE EACH	
				1 - 9	10 +
CDPKD06041	6 mm	4 mm	1/8" BSPT	£9.33	£8.35
CDPKD08042	8 mm	4 mm	1/4" BSPT	£10.05	£8.99
CDPKD08062	8 mm	6 mm	1/4" BSPT	£10.81	£9.67
CDPKD10083	10 mm	8 mm	3/8" BSPT	£10.61	£9.49

PKD-G MALE REDUCER TRIPLE BRANCH UNION



3700

PART NUMBER	TUBE OD (A)	TUBE OD (B)	THREAD	PRICE EACH	
				1 - 9	10 +
CDPKD0604G1	6 mm	4 mm	1/8" BSPP	£9.33	£8.35
CDPKD0804G2	8 mm	4 mm	1/4" BSPP	£10.05	£8.99
CDPKD0806G2	8 mm	6 mm	1/4" BSPP	£10.81	£9.67
CDPKD1006G3	10 mm	6 mm	3/8" BSPP	£10.61	£9.49
CDPKD1008G3	10 mm	8 mm	3/8" BSPP	£10.61	£9.49

TUBE TO THREAD



PHT
SINGLE UNIVERSAL TEE

3700

PART NUMBER	TUBE OD	THREAD	PRICE EACH	
			1 - 9	10 +
CDPHT0401-1	4 mm	1/8" BSPT	£6.19	£5.54
CDPHT0402-1	4 mm	1/4" BSPT	£7.91	£7.07
CDPHT0403-1	4 mm	3/8" BSPT	£10.54	£9.43
CDPHT0404-1	4 mm	1/2" BSPT	£13.45	£12.03
CDPHT0601-1	6 mm	1/8" BSPT	£6.43	£5.76
CDPHT0602-1	6 mm	1/4" BSPT	£8.15	£7.28
CDPHT0603-1	6 mm	3/8" BSPT	£10.79	£9.65
CDPHT0604-1	6 mm	1/2" BSPT	£13.70	£12.25
CDPHT0801-1	8 mm	1/8" BSPT	£6.72	£6.02
CDPHT0802-1	8 mm	1/4" BSPT	£8.44	£7.54
CDPHT0803-1	8 mm	3/8" BSPT	£11.08	£9.91
CDPHT0804-1	8 mm	1/2" BSPT	£13.98	£12.51
CDPHT1001-1	10 mm	1/8" BSPT	£7.30	£6.53
CDPHT1002-1	10 mm	1/4" BSPT	£9.00	£8.04
CDPHT1003-1	10 mm	3/8" BSPT	£11.63	£10.39
CDPHT1004-1	10 mm	1/2" BSPT	£14.55	£13.00
CDPHT1202-1	12 mm	1/4" BSPT	£9.90	£8.84
CDPHT1203-1	12 mm	3/8" BSPT	£12.54	£11.21
CDPHT1204-1	12 mm	1/2" BSPT	£15.45	£13.82



PHT-G
SINGLE UNIVERSAL TEE

3700

PART NUMBER	TUBE OD	THREAD	PRICE EACH	
			1 - 9	10 +
CDPHT04G11	4 mm	1/8" BSPP	£6.19	£5.54
CDPHT04G21	4 mm	1/4" BSPP	£7.91	£7.07
CDPHT04G31	4 mm	3/8" BSPP	£10.54	£9.43
CDPHT04G41	4 mm	1/2" BSPP	£13.45	£12.03
CDPHT06G11	6 mm	1/8" BSPP	£6.43	£5.76
CDPHT06G21	6 mm	1/4" BSPP	£8.15	£7.28
CDPHT06G31	6 mm	3/8" BSPP	£10.79	£9.65
CDPHT06G41	6 mm	1/2" BSPP	£13.70	£12.25
CDPHT08G11	8 mm	1/8" BSPP	£6.72	£6.02
CDPHT08G21	8 mm	1/4" BSPP	£8.44	£7.54
CDPHT08G31	8 mm	3/8" BSPP	£11.08	£9.91
CDPHT08G41	8 mm	1/2" BSPP	£13.98	£12.51
CDPHT10G11	10 mm	1/8" BSPP	£7.30	£6.53
CDPHT10G21	10 mm	1/4" BSPP	£9.00	£8.04
CDPHT10G31	10 mm	3/8" BSPP	£11.63	£10.39
CDPHT10G41	10 mm	1/2" BSPP	£14.55	£13.00
CDPHT12G21	12 mm	1/4" BSPP	£9.90	£8.84
CDPHT12G31	12 mm	3/8" BSPP	£12.54	£11.21
CDPHT12G41	12 mm	1/2" BSPP	£15.45	£13.82



PHT
DOUBLE UNIVERSAL TEE

3700

PART NUMBER	TUBE OD	THREAD	PRICE EACH	
			1 - 9	10 +
CDPHT0401-2	4 mm	1/8" BSPT	£10.23	£9.15
CDPHT0402-2	4 mm	1/4" BSPT	£12.77	£11.41
CDPHT0403-2	4 mm	3/8" BSPT	£16.33	£14.61
CDPHT0404-2	4 mm	1/2" BSPT	£20.56	£18.37
CDPHT0601-2	6 mm	1/8" BSPT	£10.72	£9.58
CDPHT0602-2	6 mm	1/4" BSPT	£13.25	£11.85
CDPHT0603-2	6 mm	3/8" BSPT	£16.82	£15.04
CDPHT0604-2	6 mm	1/2" BSPT	£21.04	£18.81
CDPHT0801-2	8 mm	1/8" BSPT	£11.30	£10.10
CDPHT0802-2	8 mm	1/4" BSPT	£13.84	£12.37
CDPHT0803-2	8 mm	3/8" BSPT	£17.40	£15.56
CDPHT0804-2	8 mm	1/2" BSPT	£21.63	£19.34
CDPHT1001-2	10 mm	1/8" BSPT	£12.41	£11.10
CDPHT1002-2	10 mm	1/4" BSPT	£14.95	£13.36
CDPHT1003-2	10 mm	3/8" BSPT	£18.52	£16.55
CDPHT1004-2	10 mm	1/2" BSPT	£22.75	£20.34
CDPHT1202-2	12 mm	1/4" BSPT	£23.63	£21.13
CDPHT1203-2	12 mm	3/8" BSPT	£28.18	£25.19
CDPHT1204-2	12 mm	1/2" BSPT	£33.52	£29.97



PHT-G
DOUBLE UNIVERSAL TEE

3700

PART NUMBER	TUBE OD	THREAD	PRICE EACH	
			1 - 9	10 +
CDPHT04G12	4 mm	1/8" BSPP	£10.23	£9.15
CDPHT04G22	4 mm	1/4" BSPP	£12.77	£11.41
CDPHT04G32	4 mm	3/8" BSPP	£16.33	£14.61
CDPHT04G42	4 mm	1/2" BSPP	£20.56	£18.37
CDPHT06G12	6 mm	1/8" BSPP	£10.72	£9.58
CDPHT06G22	6 mm	1/4" BSPP	£13.25	£11.85
CDPHT06G32	6 mm	3/8" BSPP	£16.82	£15.04
CDPHT06G42	6 mm	1/2" BSPP	£21.04	£18.81
CDPHT08G12	8 mm	1/8" BSPP	£11.30	£10.10
CDPHT08G22	8 mm	1/4" BSPP	£13.84	£12.37
CDPHT08G32	8 mm	3/8" BSPP	£17.40	£15.56
CDPHT08G42	8 mm	1/2" BSPP	£21.63	£19.34
CDPHT10G12	10 mm	1/8" BSPP	£12.41	£11.10
CDPHT10G22	10 mm	1/4" BSPP	£14.95	£13.36
CDPHT10G32	10 mm	3/8" BSPP	£18.52	£16.55
CDPHT10G42	10 mm	1/2" BSPP	£22.75	£20.34
CDPHT12G22	12 mm	1/4" BSPP	£23.63	£21.13
CDPHT12G32	12 mm	3/8" BSPP	£28.18	£25.19
CDPHT12G42	12 mm	1/2" BSPP	£33.52	£29.97

TUBE TO THREAD



PHT
TRIPLE UNIVERSAL TEE

3700

PART NUMBER	TUBE OD	THREAD	PRICE EACH	
			1 - 9	10 +
CDPHT0401-3	4 mm	1/8" BSPT	£13.65	£12.20
CDPHT0402-3	4 mm	1/4" BSPT	£17.66	£15.78
CDPHT0403-3	4 mm	3/8" BSPT	£22.20	£19.85
CDPHT0404-3	4 mm	1/2" BSPT	£27.55	£24.63
CDPHT0601-3	6 mm	1/8" BSPT	£14.39	£12.86
CDPHT0602-3	6 mm	1/4" BSPT	£18.39	£16.45
CDPHT0603-3	6 mm	3/8" BSPT	£22.94	£20.50
CDPHT0604-3	6 mm	1/2" BSPT	£28.28	£25.28
CDPHT0801-3	8 mm	1/8" BSPT	£15.26	£13.64
CDPHT0802-3	8 mm	1/4" BSPT	£19.27	£17.23
CDPHT0803-3	8 mm	3/8" BSPT	£23.81	£21.28
CDPHT0804-3	8 mm	1/2" BSPT	£29.16	£26.07
CDPHT1001-3	10 mm	1/8" BSPT	£16.94	£15.14
CDPHT1002-3	10 mm	1/4" BSPT	£20.94	£18.72
CDPHT1003-3	10 mm	3/8" BSPT	£25.48	£22.78
CDPHT1004-3	10 mm	1/2" BSPT	£30.83	£27.56
CDPHT1202-3	12 mm	1/4" BSPT	£23.63	£21.13
CDPHT1203-3	12 mm	3/8" BSPT	£28.18	£25.19
CDPHT1204-3	12 mm	1/2" BSPT	£33.52	£29.97



PHT-G
TRIPLE UNIVERSAL TEE

3700

PART NUMBER	TUBE OD	THREAD	PRICE EACH	
			1 - 9	10 +
CDPHT04G13	4 mm	1/8" BSPP	£13.65	£12.20
CDPHT04G23	4 mm	1/4" BSPP	£17.66	£15.78
CDPHT04G33	4 mm	3/8" BSPP	£22.20	£19.85
CDPHT04G43	4 mm	1/2" BSPP	£27.55	£24.63
CDPHT06G13	6 mm	1/8" BSPP	£14.39	£12.86
CDPHT06G23	6 mm	1/4" BSPP	£18.39	£16.45
CDPHT06G33	6 mm	3/8" BSPP	£22.94	£20.50
CDPHT06G43	6 mm	1/2" BSPP	£28.28	£25.28
CDPHT08G13	8 mm	1/8" BSPP	£15.26	£13.64
CDPHT08G23	8 mm	1/4" BSPP	£19.27	£17.23
CDPHT08G33	8 mm	3/8" BSPP	£23.81	£21.28
CDPHT08G43	8 mm	1/2" BSPP	£29.16	£26.07
CDPHT10G13	10 mm	1/8" BSPP	£16.94	£15.14
CDPHT10G23	10 mm	1/4" BSPP	£20.94	£18.72
CDPHT10G33	10 mm	3/8" BSPP	£25.48	£22.78
CDPHT10G43	10 mm	1/2" BSPP	£30.83	£27.56
CDPHT12G23	12 mm	1/4" BSPP	£23.63	£21.13
CDPHT12G33	12 mm	3/8" BSPP	£28.18	£25.19
CDPHT12G43	12 mm	1/2" BSPP	£33.52	£29.97



PA
DUAL MALE BANJO

3700

PART NUMBER	TUBE OD	THREAD	PRICE EACH	
			1 - 9	10 +
CDPA04M5	4 mm	M5 x 0.8	£6.58	£5.88
CDPA0601	6 mm	1/8" BSPT	£6.36	£5.68
CDPA0802	8 mm	1/4" BSPT	£8.28	£7.41
CDPA1002	10 mm	1/4" BSPT	£9.79	£8.75
CDPA1003	10 mm	3/8" BSPT	£11.22	£10.02
CDPA1203	12 mm	3/8" BSPT	£12.41	£11.09
CDPA1204	12 mm	1/2" BSPT	£14.14	£12.64



PA-G
DUAL MALE BANJO

3700

PART NUMBER	TUBE OD	THREAD	PRICE EACH	
			1 - 9	10 +
CDPA06G01	6 mm	1/8" BSPP	£6.36	£5.68
CDPA08G02	8 mm	1/4" BSPP	£8.28	£7.41
CDPA10G02	10 mm	1/4" BSPP	£9.79	£8.75
CDPA10G03	10 mm	3/8" BSPP	£11.22	£10.02
CDPA12G03	12 mm	3/8" BSPP	£12.41	£11.09
CDPA12G04	12 mm	1/2" BSPP	£14.14	£12.64



PAF
DUAL FEMALE
STACKING BANJO

3700

PART NUMBER	TUBE OD	THREAD	PRICE EACH	
			1 - 9	10 +
CDPAF04M5	4 mm	M5 x 0.8	£6.86	£6.13
CDPAF0601	6 mm	1/8" BSPT	£7.58	£6.78
CDPAF0802	8 mm	1/4" BSPT	£9.50	£8.49
CDPAF1002	10 mm	1/4" BSPT	£11.63	£10.39
CDPAF1003	10 mm	3/8" BSPT	£12.92	£11.55
CDPAF1203	12 mm	3/8" BSPT	£14.18	£12.67
CDPAF1204	12 mm	1/2" BSPT	£15.76	£14.09



PAF-G
DUAL FEMALE
STACKING BANJO

3700

PART NUMBER	TUBE OD	THREAD	PRICE EACH	
			1 - 9	10 +
CDPAF06G01	6 mm	1/8" BSPP	£7.58	£6.78
CDPAF08G02	8 mm	1/4" BSPP	£9.50	£8.49
CDPAF10G02	10 mm	1/4" BSPP	£11.63	£10.39
CDPAF10G03	10 mm	3/8" BSPP	£12.92	£11.55
CDPAF12G03	12 mm	3/8" BSPP	£14.18	£12.67
CDPAF12G04	12 mm	1/2" BSPP	£15.76	£14.09

TUBE TO THREAD



PAT
DOUBLE BRANCH MALE BANJO

3700



PAT-G
DOUBLE BRANCH MALE BANJO

3700

PART NUMBER	TUBE OD	THREAD	PRICE EACH	
			1 - 9	10 +
CDPAT04012	4 mm	1/8" BSPT	£11.51	£10.28
CDPAT04022	4 mm	1/4" BSPT	£14.34	£12.82
CDPAT04032	4 mm	3/8" BSPT	£18.37	£16.42
CDPAT04042	4 mm	1/2" BSPT	£23.13	£20.68
CDPAT06012	6 mm	1/8" BSPT	£12.05	£10.77
CDPAT06022	6 mm	1/4" BSPT	£14.90	£13.32
CDPAT06032	6 mm	3/8" BSPT	£18.92	£16.92
CDPAT06042	6 mm	1/2" BSPT	£23.70	£21.18
CDPAT08012	8 mm	1/8" BSPT	£12.71	£11.36
CDPAT08022	8 mm	1/4" BSPT	£15.54	£13.90
CDPAT08032	8 mm	3/8" BSPT	£19.58	£17.50
CDPAT08042	8 mm	1/2" BSPT	£24.34	£21.76
CDPAT10022	10 mm	1/4" BSPT	£16.81	£15.02
CDPAT10032	10 mm	3/8" BSPT	£20.84	£18.63
CDPAT10042	10 mm	1/2" BSPT	£25.61	£22.90
CDPAT12022	12 mm	1/4" BSPT	£18.83	£16.83
CDPAT12032	12 mm	3/8" BSPT	£22.86	£20.44
CDPAT12042	12 mm	1/2" BSPT	£27.64	£24.70

PART NUMBER	TUBE OD	THREAD	PRICE EACH	
			1 - 9	10 +
CDPAT04G012	4 mm	1/8" BSPP	£11.51	£10.28
CDPAT04G022	4 mm	1/4" BSPP	£14.34	£12.82
CDPAT04G032	4 mm	3/8" BSPP	£18.37	£16.42
CDPAT04G042	4 mm	1/2" BSPP	£23.13	£20.68
CDPAT06G012	6 mm	1/8" BSPP	£12.05	£10.77
CDPAT06G022	6 mm	1/4" BSPP	£14.90	£13.32
CDPAT06G032	6 mm	3/8" BSPP	£18.92	£16.92
CDPAT06G042	6 mm	1/2" BSPP	£23.70	£21.18
CDPAT08G012	8 mm	1/8" BSPP	£12.71	£11.36
CDPAT08G022	8 mm	1/4" BSPP	£15.54	£13.90
CDPAT08G032	8 mm	3/8" BSPP	£19.58	£17.50
CDPAT08G042	8 mm	1/2" BSPP	£24.34	£21.76
CDPAT10G022	10 mm	1/4" BSPP	£16.81	£15.02
CDPAT10G032	10 mm	3/8" BSPP	£20.84	£18.63
CDPAT10G042	10 mm	1/2" BSPP	£25.61	£22.90
CDPAT12G022	12 mm	1/4" BSPP	£18.83	£16.83
CDPAT12G032	12 mm	3/8" BSPP	£22.86	£20.44
CDPAT12G042	12 mm	1/2" BSPP	£27.64	£24.70



PAT
TRIPLE BRANCH MALE BANJO

3700



PAT-G
TRIPLE BRANCH MALE BANJO

3700

PART NUMBER	TUBE OD	THREAD	PRICE EACH	
			1 - 9	10 +
CDPAT04013	4 mm	1/8" BSPT	£15.33	£13.71
CDPAT04023	4 mm	1/4" BSPT	£19.84	£17.74
CDPAT04033	4 mm	3/8" BSPT	£24.96	£22.31
CDPAT04043	4 mm	1/2" BSPT	£31.00	£27.71
CDPAT06013	6 mm	1/8" BSPT	£16.17	£14.45
CDPAT06023	6 mm	1/4" BSPT	£20.66	£18.46
CDPAT06033	6 mm	3/8" BSPT	£25.80	£23.06
CDPAT06043	6 mm	1/2" BSPT	£31.83	£28.45
CDPAT08013	8 mm	1/8" BSPT	£17.15	£15.33
CDPAT08023	8 mm	1/4" BSPT	£21.65	£19.35
CDPAT08033	8 mm	3/8" BSPT	£26.77	£23.94
CDPAT08043	8 mm	1/2" BSPT	£32.81	£29.33
CDPAT10023	10 mm	1/4" BSPT	£23.53	£21.04
CDPAT10033	10 mm	3/8" BSPT	£28.67	£25.63
CDPAT10043	10 mm	1/2" BSPT	£34.70	£31.02
CDPAT12023	12 mm	1/4" BSPT	£26.59	£23.76
CDPAT12033	12 mm	3/8" BSPT	£31.71	£28.34
CDPAT12043	12 mm	1/2" BSPT	£37.75	£33.74

PART NUMBER	TUBE OD	THREAD	PRICE EACH	
			1 - 9	10 +
CDPAT04G013	4 mm	1/8" BSPP	£15.33	£13.71
CDPAT04G023	4 mm	1/4" BSPP	£19.84	£17.74
CDPAT04G033	4 mm	3/8" BSPP	£24.96	£22.32
CDPAT04G043	4 mm	1/2" BSPP	£31.01	£27.71
CDPAT06G013	6 mm	1/8" BSPP	£16.17	£14.45
CDPAT06G023	6 mm	1/4" BSPP	£20.66	£18.46
CDPAT06G033	6 mm	3/8" BSPP	£25.80	£23.06
CDPAT06G043	6 mm	1/2" BSPP	£31.83	£28.45
CDPAT08G013	8 mm	1/8" BSPP	£17.15	£15.33
CDPAT08G023	8 mm	1/4" BSPP	£21.65	£19.35
CDPAT08G033	8 mm	3/8" BSPP	£26.78	£23.95
CDPAT08G043	8 mm	1/2" BSPP	£32.82	£29.33
CDPAT12G023	12 mm	1/4" BSPP	£26.59	£23.76
CDPAT12G033	12 mm	3/8" BSPP	£31.71	£28.36
CDPAT12G043	12 mm	1/2" BSPP	£37.75	£33.74

METRIC TUBE TO TUBE



PKG
REDUCER
TRIPLE BRANCH UNION

3700

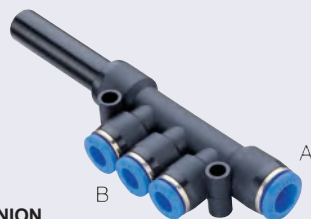

PKJ
PLUG-IN REDUCER
TRIPLE BRANCH UNION

3700

PART NUMBER	TUBE OD (A)	TUBE OD (B)	PRICE EACH	
			1 - 9	10 +
CDPKG0604N	6 mm	4 mm	£8.94	£7.99
CDPKG0804N	8 mm	4 mm	£9.33	£8.35
CDPKG0806N	8 mm	6 mm	£9.69	£8.66
CDPKG1006N	10 mm	6 mm	£10.42	£9.30
CDPKG1008N	10 mm	8 mm	£10.81	£9.67

PART NUMBER	TUBE OD (A)	TUBE OD (B)	STEM	PRICE EACH	
				1 - 9	10 +
CDPKJ0604N	6 mm	4 mm	6 mm	£10.83	£9.69
CDPKJ0804N	8 mm	4 mm	8 mm	£11.64	£10.42
CDPKJ0806N	8 mm	6 mm	8 mm	£12.52	£11.18
CDPKJ1006N	10 mm	6 mm	10 mm	£12.11	£10.82
CDPKJ1008N	10 mm	8 mm	10 mm	£13.02	£11.64



PP
PLUG

3700

PART NUMBER	TUBE OD	PRICE EACH	
		1 - 9	10 +
CDPP04N	4 mm	£0.83	£0.73
CDPP06N	6 mm	£0.83	£0.73
CDPP08N	8 mm	£0.92	£0.83
CDPP10N	10 mm	£1.08	£0.96
CDPP12N	12 mm	£1.23	£1.11
CDPP16N	16 mm	£2.99	£2.68



PXG
DOUBLE REDUCER 'Y'

3700

PART NUMBER	TUBE OD (A)	TUBE OD (B)	PRICE EACH	
			1 - 9	10 +
CDPXG0604N	6 mm	4 mm	£7.49	£6.70
CDPXG0806N	8 mm	6 mm	£10.10	£9.03



PLM
BULKHEAD UNION ELBOW

3700

PART NUMBER	TUBE OD	TUBE OD	PRICE EACH	
			1 - 9	10 +
CDPLM04N	4 mm	4 mm	£5.33	£4.76
CDPLM06N	6 mm	6 mm	£6.62	£5.92
CDPLM08N	8 mm	8 mm	£8.14	£7.27
CDPLM10N	10 mm	10 mm	£11.40	£10.19
CDPLM12N	12 mm	12 mm	£14.30	£12.80



PMP
BULKHEAD UNION

3700

PART NUMBER	TUBE OD	TUBE OD	PRICE EACH	
			1 - 9	10 +
CDPMP04N	4 mm	4 mm	£2.93	£2.62
CDPMP06N	6 mm	6 mm	£3.00	£2.69
CDPMP08N	8 mm	8 mm	£3.15	£2.81
CDPMP10N	10 mm	10 mm	£4.07	£3.63
CDPMP12N	12 mm	12 mm	£4.42	£3.96



CAS
CARTRIDGE

3700

PART NUMBER	TUBE OD	HOLE OD	PRICE EACH	
			1 - 9	10 +
CDCAS04	4 mm	8.95 mm	£1.42	£1.27
CDCAS06	6 mm	11.10 mm	£1.51	£1.36
CDCAS08	8 mm	13.20 mm	£1.64	£1.46
CDCAS10	10 mm	15.45 mm	£1.89	£1.69
CDCAS12	12 mm	17.75 mm	£2.26	£2.02

METRIC TUBE TO TUBE

PLJ
PLUG-IN ELBOW



3700

PART NUMBER	STEM OD	TUBE OD	PRICE EACH	
			1 - 9	10 +
CDPLJ04N	4 mm	4 mm	£2.72	£2.44
CDPLJ06N	6 mm	6 mm	£3.01	£2.69
CDPLJ08N	8 mm	8 mm	£3.35	£3.00
CDPLJ10N	10 mm	10 mm	£3.71	£3.32
CDPLJ12N	12 mm	12 mm	£4.86	£4.35
CDPLJ16N	16 mm	16 mm	£3.85	£3.45

PGJ
PLUG-IN REDUCER



3700

PART NUMBER	STEM OD (B)	TUBE OD (A)	PRICE EACH	
			1 - 9	10 +
CDPGJ0406N	4 mm	6 mm	£1.42	£1.27
CDPGJ0604N	6 mm	4 mm	£1.42	£1.27
CDPGJ0608N	6 mm	8 mm	£1.59	£1.42
CDPGJ0804N	8 mm	4 mm	£1.42	£1.27
CDPGJ0806N	8 mm	6 mm	£1.59	£1.42
CDPGJ1006N	10 mm	6 mm	£1.59	£1.42
CDPGJ1008N	10 mm	8 mm	£1.77	£1.59
CDPGJ1206N	12 mm	6 mm	£2.00	£1.79
CDPGJ1208N	12 mm	8 mm	£2.02	£1.80
CDPGJ1210N	12 mm	10 mm	£2.08	£1.87

PYJ
PLUG-IN 'Y'



3700

PART NUMBER	STEM OD	TUBE OD	PRICE EACH	
			1 - 9	10 +
CDPYJ04N	4 mm	4 mm	£4.64	£4.14
CDPYJ06N	6 mm	6 mm	£5.11	£4.57
CDPYJ08N	8 mm	8 mm	£5.68	£5.09
CDPYJ10N	10 mm	10 mm	£6.32	£5.65
CDPYJ12N	12 mm	12 mm	£7.33	£6.55

PWJ
PLUG-IN REDUCER 'Y'



3700

PART NUMBER	STEM OD (B)	TUBE OD (A)	PRICE EACH	
			1 - 9	10 +
CDPWJ0604N	6 mm	4 mm	£5.14	£4.59
CDPWJ0806N	8 mm	6 mm	£5.64	£5.04
CDPWJ1008N	10 mm	8 mm	£6.26	£5.59
CDPWJ1210N	12 mm	10 mm	£7.34	£6.56

PIJ
TUBE SPLICER



3700

PART NUMBER	STEM OD	PRICE EACH	
		1 - 9	10 +
CDPIJ04	4 mm	£1.06	£0.94
CDPIJ06	6 mm	£1.23	£1.11
CDPIJ08	8 mm	£1.41	£1.26
CDPIJ10	10 mm	£1.54	£1.38
CDPIJ12	12 mm	£1.97	£1.76
CDPIJ16	16 mm	£2.86	£2.56

PIG
REDUCER TUBE SPLICER



3700

PART NUMBER	STEM OD (A)	STEM OD (B)	PRICE EACH	
			1 - 9	10 +
CDPIG0604	6 mm	4 mm	£1.43	£1.27
CDPIG0804	8 mm	4 mm	£1.54	£1.38
CDPIG0806	8 mm	6 mm	£1.54	£1.38
CDPIG1006	10 mm	6 mm	£1.59	£1.42
CDPIG1008	10 mm	8 mm	£1.59	£1.42
CDPIG1208	12 mm	8 mm	£1.79	£1.61
CDPIG1210	12 mm	10 mm	£1.79	£1.61
CDPIG1612	16 mm	12 mm	£3.40	£3.03

PSJ
PLUG-IN RUN TEE



3700

PART NUMBER	STEM OD (A)	TUBE OD (B)	PRICE EACH	
			1 - 9	10 +
CDPSJ04N	4 mm	4 mm	£2.72	£2.44
CDPSJ0604N	6 mm	4 mm	£3.01	£2.69
CDPSJ06N	6 mm	6 mm	£3.01	£2.69
CDPSJ0806N	8 mm	6 mm	£3.35	£3.00
CDPSJ08N	8 mm	8 mm	£3.35	£3.00
CDPSJ1008N	10 mm	8 mm	£3.71	£3.32
CDPSJ10N	10 mm	10 mm	£3.71	£3.32
CDPSJ1210N	12 mm	10 mm	£4.86	£4.35
CDPSJ12N	12 mm	12 mm	£4.86	£4.35

PTJ
PLUG-IN BRANCH TEE



3700

PART NUMBER	STEM OD (A)	TUBE OD (B)	PRICE EACH	
			1 - 9	10 +
CDPTJ04N	4 mm	4 mm	£2.72	£2.44
CDPTJ0604N	6 mm	4 mm	£3.01	£2.69
CDPTJ06N	6 mm	6 mm	£3.01	£2.69
CDPTJ0806N	8 mm	6 mm	£3.35	£3.00
CDPTJ08N	8 mm	8 mm	£3.35	£3.00
CDPTJ1008N	10 mm	8 mm	£3.71	£3.32
CDPTJ10N	10 mm	10 mm	£3.71	£3.32
CDPTJ1210N	12 mm	10 mm	£4.86	£4.35
CDPTJ12N	12 mm	12 mm	£4.86	£4.35

IMPERIAL TUBE TO TUBE



PUC
EQUAL STRAIGHT UNION

3700

PART NUMBER	TUBE OD	PRICE EACH	
		1 - 9	10 +
CDPUC5/32	5/32"	£2.25	£2.02
CDPUC3/16	3/16"	£2.48	£2.22
CDPUC1/4	1/4"	£2.48	£2.22
CDPUC5/16	5/16"	£2.59	£2.32
CDPUC3/8	3/8"	£2.93	£2.62
CDPUC1/2	1/2"	£3.94	£3.52



PGT
REDUCER TEE

3700

PART NUMBER	TUBE OD (A)	TUBE OD (B)	PRICE EACH	
			1 - 9	10 +
CDPGT1/45/32	1/4"	5/32"	£3.49	£3.11
CDPGT5/161/4	5/16"	1/4"	£3.59	£3.21
CDPGT3/81/4	3/8"	1/4"	£3.73	£3.33
CDPGT3/85/16	3/8"	5/16"	£3.79	£3.38
CDPGT1/23/8	1/2"	3/8"	£5.32	£4.76

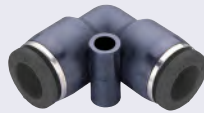

PUL
EQUAL UNION ELBOW

3700

PART NUMBER	TUBE OD	PRICE EACH	
		1 - 9	10 +
CDPUL5/32	5/32"	£2.37	£2.12
CDPUL3/16	3/16"	£2.48	£2.22
CDPUL1/4	1/4"	£2.48	£2.21
CDPUL5/16	5/16"	£2.59	£2.32
CDPUL3/8	3/8"	£2.93	£2.62
CDPUL1/2	1/2"	£3.94	£3.52



PZA
UNION CROSS

3700

PART NUMBER	TUBE OD	TUBE OD	PRICE EACH	
			1 - 9	10 +
CDPZA5/32	5/32"	5/32"	£5.58	£4.99
CDPZA3/16	3/16"	3/16"	£6.21	£5.55
CDPZA1/4	1/4"	1/4"	£6.21	£5.55
CDPZA5/16	5/16"	5/16"	£6.38	£5.70
CDPZA3/8	3/8"	3/8"	£7.32	£6.54
CDPZA1/2	1/2"	1/2"	£7.76	£6.94



PUT
EQUAL UNION TEE

3700

PART NUMBER	TUBE OD	PRICE EACH	
		1 - 9	10 +
CDPUT5/32	5/32"	£3.83	£3.43
CDPUT3/16	3/16"	£3.83	£3.43
CDPUT1/4	1/4"	£3.83	£3.43
CDPUT5/16	5/16"	£3.95	£3.53
CDPUT3/8	3/8"	£4.16	£3.73
CDPUT1/2	1/2"	£5.85	£5.24



PMM
BULKHEAD UNION

3700

PART NUMBER	TUBE OD	TUBE OD	PRICE EACH	
			1 - 9	10 +
CDPMM5/32N	5/32"	5/32"	£4.22	£3.77
CDPMM3/16N	3/16"	3/16"	£5.30	£4.74
CDPMM1/4N	1/4"	1/4"	£5.29	£4.73
CDPMM5/16N	5/16"	5/16"	£6.38	£5.70
CDPMM3/8N	3/8"	3/8"	£9.10	£8.14
CDPMM1/2N	1/2"	1/2"	£12.41	£11.10



PG
REDUCER

3700

PART NUMBER	TUBE OD	TUBE OD	PRICE EACH	
			1 - 9	10 +
CDPG3/165/32	3/16"	5/32"	£2.51	£2.24
CDPG1/45/32	1/4"	5/32"	£2.50	£2.24
CDPG1/43/16	1/4"	3/16"	£2.50	£2.24
CDPG5/161/4	5/16"	1/4"	£2.74	£2.45
CDPG3/81/4	3/8"	1/4"	£3.62	£3.24
CDPG3/85/16	3/8"	5/16"	£3.62	£3.24
CDPG1/23/8	1/2"	3/8"	£3.79	£3.38



PPF
CAP

3700

PART NUMBER	TUBE OD	PRICE EACH	
		1 - 9	10 +
CDPPF5/32	5/32"	£1.71	£1.53
CDPPF3/16	3/16"	£1.88	£1.68
CDPPF1/4	1/4"	£1.88	£1.68
CDPPF5/16	5/16"	£2.04	£1.82
CDPPF3/8	3/8"	£2.48	£2.21
CDPPF1/2	1/2"	£2.72	£2.44

IMPERIAL TUBE TO TUBE



PY
EQUAL UNION 'Y'

3700

PART NUMBER	TUBE OD	PRICE EACH	
		1 - 9	10 +
CDPY5/32	5/32"	£4.68	£4.19
CDPY3/16	3/16"	£4.68	£4.19
CDPY1/4	1/4"	£4.67	£4.19
CDPY5/16	5/16"	£5.20	£4.65
CDPY3/8	3/8"	£6.47	£5.79
CDPY1/2	1/2"	£5.88	£5.26



PW
REDUCER 'Y'

3700

PART NUMBER	TUBE OD (A)	TUBE OD (B)	PRICE EACH	
			1 - 9	10 +
CDPW3/165/32	3/16"	5/32"	£3.59	£3.21
CDPW1/45/32	1/4"	5/32"	£3.58	£3.20
CDPW1/43/16	1/4"	3/16"	£3.58	£3.20
CDPW5/161/4	5/16"	1/4"	£3.75	£3.35
CDPW3/81/4	3/8"	1/4"	£4.34	£3.88
CDPW3/85/16	3/8"	5/16"	£4.34	£3.88
CDPW1/23/8	1/2"	3/8"	£6.37	£5.69

IMPERIAL TO THREAD BSPT



PC
MALE STRAIGHT

3700

PART NUMBER	TUBE OD	THREAD	PRICE EACH	
			1 - 9	10 +
CDPC1/401	1/4"	1/8" BSPT	£2.12	£1.89
CDPC1/402	1/4"	1/4" BSPT	£2.23	£1.99
CDPC1/403	1/4"	3/8" BSPT	£2.78	£2.49
CDPC3/801	3/8"	1/8" BSPT	£3.08	£2.76
CDPC3/802	3/8"	1/4" BSPT	£3.02	£2.71
CDPC3/803	3/8"	3/8" BSPT	£3.04	£2.72
CDPC3/804	3/8"	1/2" BSPT	£3.79	£3.38
CDPC1/202	1/2"	1/4" BSPT	£3.80	£3.40
CDPC1/203	1/2"	3/8" BSPT	£3.93	£3.51
CDPC1/204	1/2"	1/2" BSPT	£4.41	£3.95



PL – SWIVEL ROTATING
MALE ELBOW

3700

PART NUMBER	TUBE OD	THREAD	PRICE EACH	
			1 - 9	10 +
CDPL1/401	1/4"	1/8" BSPT	£2.66	£2.38
CDPL1/402	1/4"	1/4" BSPT	£2.85	£2.55
CDPL1/403	1/4"	3/8" BSPT	£3.34	£2.99
CDPL3/801	3/8"	1/8" BSPT	£4.27	£3.81
CDPL3/802	3/8"	1/4" BSPT	£4.30	£3.84
CDPL3/803	3/8"	3/8" BSPT	£4.32	£3.86
CDPL3/804	3/8"	1/2" BSPT	£5.17	£4.62
CDPL1/202	1/2"	1/4" BSPT	£5.18	£4.63
CDPL1/203	1/2"	3/8" BSPT	£5.36	£4.80
CDPL1/204	1/2"	1/2" BSPT	£5.65	£5.05



PCF
FEMALE STRAIGHT

3700

PART NUMBER	TUBE OD	THREAD	PRICE EACH	
			1 - 9	10 +
CDPCF1/401	1/4"	1/8" BSPT	£3.12	£2.79
CDPCF1/402	1/4"	1/4" BSPT	£3.40	£3.03
CDPCF3/802	3/8"	1/4" BSPT	£4.50	£4.02
CDPCF3/803	3/8"	3/8" BSPT	£5.67	£5.07



PT – SWIVEL ROTATING
MALE BRANCH TEE

3700

PART NUMBER	TUBE OD	THREAD	PRICE EACH	
			1 - 9	10 +
CDPT1/401	1/4"	1/8" BSPT	£3.94	£3.52
CDPT1/402	1/4"	1/4" BSPT	£4.13	£3.70
CDPT1/403	1/4"	3/8" BSPT	£4.82	£4.31
CDPT3/801	3/8"	1/8" BSPT	£5.63	£5.03
CDPT3/802	3/8"	1/4" BSPT	£5.74	£5.13
CDPT3/803	3/8"	3/8" BSPT	£6.04	£5.40
CDPT3/804	3/8"	1/2" BSPT	£6.66	£5.95
CDPT1/202	1/2"	1/4" BSPT	£6.62	£5.92
CDPT1/203	1/2"	3/8" BSPT	£6.78	£6.06
CDPT1/204	1/2"	1/2" BSPT	£7.08	£6.33

IMPERIAL TUBE TO THREAD NPT



PC-NPT
MALE STRAIGHT

3700

PART NUMBER	TUBE OD	THREAD	PRICE EACH	
			1 - 9	10 +
CDPC1/4N02	1/4"	1/4" NPT	£2.23	£1.99
CDPC3/8N03	3/8"	3/8" NPT	£3.04	£2.72
CDPC1/2N04	1/2"	1/2" NPT	£4.41	£3.95



PCF-NPT
FEMALE STRAIGHT

3700

PART NUMBER	TUBE OD	THREAD	PRICE EACH	
			1 - 9	10 +
CDPCF1/4N02	1/4"	1/4" NPT	£3.40	£3.03
CDPCF3/8N03	3/8"	3/8" NPT	£5.67	£5.07



PL-NPT – SWIVEL ROTATING
MALE ELBOW

3700

PART NUMBER	TUBE OD	THREAD	PRICE EACH	
			1 - 9	10 +
CDPL1/4N02	1/4"	1/4" NPT	£2.85	£2.55
CDPL3/8N03	3/8"	3/8" NPT	£4.32	£3.86
CDPL1/2N04	1/2"	1/2" NPT	£5.65	£5.05



PT-NPT – SWIVEL ROTATING
MALE BRANCH TEE

3700

PART NUMBER	TUBE OD	THREAD	PRICE EACH	
			1 - 9	10 +
CDPT1/4N02	1/4"	1/4" NPT	£3.94	£3.52
CDPT3/8N03	3/8"	3/8" NPT	£6.04	£5.40
CDPT1/2N04	1/2"	1/2" NPT	£7.08	£6.33

FEATURES

- One touch, push-to-connect configuration allows instant tubing connection
- Volume and OD are smaller than regular type, but same flux is obtained
- Electroless nickel coated surfaces for excellent tolerance to corrosion
- Oval sleeve is designed to allow easy release in limited spaces
- The screw section has an O-ring and Teflon coating
- Miniaturised fittings for small devices and piping in limited spaces

APPLICATIONS

- Mini one touch type pipe connection tool for air pressure piping in limited spaces
- Various uses depending on the user's environment

SPECIFICATIONS

Fluid type	Air (No other type of gas or liquid)
Working pressure	0 to 150 psi (10.2 bar)
Negative pressure	-29.5 in Hg -750 mm Hg (-750 Torr)
Working temperature	0°C to +60°C (+32°F to +140°F)
Application tube	Polyurethane and nylon

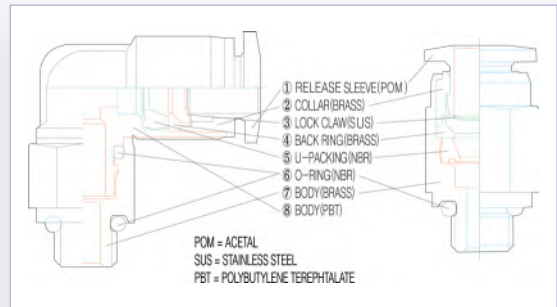

METRIC TUBE TO THREAD



PC-C
MALE STRAIGHT

3700

PART NUMBER	TUBE OD	THREAD	PRICE EACH	
			1 - 9	10 +
CDPC-C03M3	3 mm	M3 x 0.5	£2.14	£1.91
CDPC-C03M5	3 mm	M5 x 0.8	£2.24	£2.00
CDPC-C03M6	3 mm	M6 x 1.0	£2.24	£2.00
CDPC-C04M3	4 mm	M3 x 0.5	£2.07	£1.86
CDPC-C04M5	4 mm	M5 x 0.8	£2.07	£1.86
CDPC-C04M6	4 mm	M6 x 1.0	£2.27	£2.03
CDPC-C0401	4 mm	1/8" BSPT	£1.99	£1.78
CDPC-C06M5	6 mm	M5 x 0.8	£2.52	£2.25
CDPC-C06M6	6 mm	M6 x 1.0	£2.52	£2.26
CDPC-C0601	6 mm	1/8" BSPT	£2.13	£1.90



PCF-C
FEMALE STRAIGHT

3700

PART NUMBER	TUBE OD	THREAD	PRICE EACH	
			1 - 9	10 +
CDPCF-C03M3	3 mm	M3 x 0.5	£3.79	£3.40
CDPCF-C03M5	3 mm	M5 x 0.8	£3.79	£3.40
CDPCF-C03M6	3 mm	M6 x 1.0	£3.80	£3.40
CDPCF-C04M3	4 mm	M3 x 0.5	£3.81	£3.41
CDPCF-C04M5	4 mm	M5 x 0.8	£3.81	£3.41
CDPCF-C04M6	4 mm	M6 x 1.0	£3.82	£3.42
CDPCF-C0401	4 mm	1/8" BSPT	£2.82	£2.52
CDPCF-C06M5	6 mm	M5 x 0.8	£3.92	£3.50
CDPCF-C06M6	6 mm	M6 x 1.0	£3.93	£3.51
CDPCF-C0601	6 mm	1/8" BSPT	£3.14	£2.80



POC-C
ROUND MALE STRAIGHT

3700

PART NUMBER	TUBE OD	THREAD	PRICE EACH	
			1 - 9	10 +
CDPOC-C03M3	3 mm	M3 x 0.5	£3.34	£2.99
CDPOC-C03M5	3 mm	M5 x 0.8	£3.34	£2.99
CDPOC-C03M6	3 mm	M6 x 1.0	£3.35	£3.00
CDPOC-C04M3	4 mm	M3 x 0.5	£3.35	£3.00
CDPOC-C04M5	4 mm	M5 x 0.8	£3.35	£3.00
CDPOC-C04M6	4 mm	M6 x 1.0	£3.36	£3.01
CDPOC-C0401	4 mm	1/8" BSPT	£2.49	£2.23
CDPOC-C06M5	6 mm	M5 x 0.8	£3.45	£3.08
CDPOC-C06M6	6 mm	M6 x 1.0	£3.46	£3.09
CDPOC-C0601	6 mm	1/8" BSPT	£2.76	£2.47



PL-C – SWIVEL ROTATING
MALE ELBOW

3700

PART NUMBER	TUBE OD	THREAD	PRICE EACH	
			1 - 9	10 +
CDPL-C03M3	3 mm	M3 x 0.5	£3.45	£3.08
CDPL-C03M5	3 mm	M5 x 0.8	£3.45	£3.08
CDPL-C03M6	3 mm	M6 x 1.0	£3.46	£3.09
CDPL-C04M3	4 mm	M3 x 0.5	£3.47	£3.09
CDPL-C04M5	4 mm	M5 x 0.8	£3.47	£3.09
CDPL-C04M6	4 mm	M6 x 1.0	£3.47	£3.10
CDPL-C0401	4 mm	1/8" BSPT	£2.56	£2.29
CDPL-C06M5	6 mm	M5 x 0.8	£3.56	£3.19
CDPL-C06M6	6 mm	M6 x 1.0	£3.57	£3.19
CDPL-C0601	6 mm	1/8" BSPT	£2.84	£2.54

METRIC TUBE TO THREAD

PLL-C – SWIVEL ROTATING
EXTENDED MALE ELBOW



3700

PART NUMBER	TUBE OD	THREAD	PRICE EACH	
			1 - 9	10 +
CDPLL-C03M3	3 mm	M3 x 0.5	£6.32	£5.64
CDPLL-C03M5	3 mm	M5 x 0.8	£5.34	£4.77
CDPLL-C03M6	3 mm	M6 x 1.0	£5.34	£4.77
CDPLL-C04M3	4 mm	M3 x 0.5	£6.46	£5.78
CDPLL-C04M5	4 mm	M5 x 0.8	£4.22	£3.77
CDPLL-C04M6	4 mm	M6 x 1.0	£4.28	£3.83
CDPLL-C0401	4 mm	1/8" BSPT	£3.92	£3.50
CDPLL-C06M5	6 mm	M5 x 0.8	£4.51	£4.03
CDPLL-C06M6	6 mm	M6 x 1.0	£4.65	£4.16
CDPLL-C0601	6 mm	1/8" BSPT	£4.35	£3.89

PST-C – SWIVEL ROTATING
MALE RUN TEE



3700

PART NUMBER	TUBE OD	THREAD	PRICE EACH	
			1 - 9	10 +
CDPST-C03M3	3 mm	M3 x 0.5	£4.72	£4.22
CDPST-C03M5	3 mm	M5 x 0.8	£4.72	£4.22
CDPST-C03M6	3 mm	M6 x 1.0	£4.72	£4.22
CDPST-C04M3	4 mm	M3 x 0.5	£4.78	£4.27
CDPST-C04M5	4 mm	M5 x 0.8	£4.78	£4.27
CDPST-C04M6	4 mm	M6 x 1.0	£4.78	£4.28
CDPST-C0401	4 mm	1/8" BSPT	£4.07	£3.63
CDPST-C06M5	6 mm	M5 x 0.8	£4.98	£4.45
CDPST-C06M6	6 mm	M6 x 1.0	£4.99	£4.46
CDPST-C0601	6 mm	1/8" BSPT	£4.19	£3.74

PT-C – SWIVEL ROTATING
MALE BRANCH TEE



3700

PART NUMBER	TUBE OD	THREAD	PRICE EACH	
			1 - 9	10 +
CDPT-C03M3	3 mm	M3 x 0.5	£4.37	£3.90
CDPT-C03M5	3 mm	M5 x 0.8	£4.37	£3.90
CDPT-C03M6	3 mm	M6 x 1.0	£4.38	£3.92
CDPT-C04M3	4 mm	M3 x 0.5	£4.42	£3.96
CDPT-C04M5	4 mm	M5 x 0.8	£4.42	£3.96
CDPT-C04M6	4 mm	M6 x 1.0	£4.44	£3.97
CDPT-C0401	4 mm	1/8" BSPT	£3.77	£3.37
CDPT-C06M5	6 mm	M5 x 0.8	£4.61	£4.12
CDPT-C06M6	6 mm	M6 x 1.0	£4.62	£4.13
CDPT-C0601	6 mm	1/8" BSPT	£3.87	£3.47

PL-G-C – SWIVEL ROTATING
MALE NIPPLE ELBOW



3700

PART NUMBER	TUBE OD	THREAD	PRICE EACH	
			1 - 9	10 +
CDPL-C04G01	4 mm	1/8"	£2.31	£2.06
CDPL-C06G01	6 mm	1/8"	£2.85	£2.55

PC-G-C
MALE NIPPLE



3700

PART NUMBER	TUBE OD	THREAD	PRICE EACH	
			1 - 9	10 +
CDPC-C04G01	4 mm	1/8"	£1.99	£1.78
CDPC-C06G01	6 mm	1/8"	£2.13	£1.90

METRIC TUBE TO TUBE

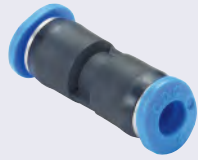

PUC-C
STRAIGHT UNION

3700

PART NUMBER	TUBE OD	PRICE EACH	
		1 - 9	10 +
CDPUC-C03	3 mm	£2.18	£1.94
CDPUC-C04	4 mm	£2.23	£1.99
CDPUC-C06	6 mm	£2.46	£2.20



PMM-C
BULKHEAD UNION

3700

PART NUMBER	TUBE OD	PRICE EACH	
		1 - 9	10 +
CDPMM-C03	3 mm	£4.03	£3.60
CDPMM-C04	4 mm	£4.35	£3.88
CDPMM-C06	6 mm	£4.83	£4.32

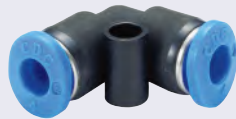

PUL-C
UNION ELBOW

3700

PART NUMBER	TUBE OD	PRICE EACH	
		1 - 9	10 +
CDPUL-C03	3 mm	£2.18	£1.94
CDPUL-C04	4 mm	£2.23	£1.99
CDPUL-C06	6 mm	£2.46	£2.20



PUT-C
UNION TEE

3700

PART NUMBER	TUBE OD	PRICE EACH	
		1 - 9	10 +
CDPUT-C03	3 mm	£3.38	£3.03
CDPUT-C04	4 mm	£3.49	£3.12
CDPUT-C06	6 mm	£3.88	£3.47

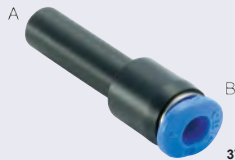

PGJ-C
PLUG-IN REDUCER

3700

PART NUMBER	TUBE OD (A)	TUBE OD (B)	PRICE EACH	
			1 - 9	10 +
CDPGJ-C0403	4 mm	3 mm	£3.38	£3.02
CDPGJ-C0603	6 mm	3 mm	£3.69	£3.29
CDPGJ-C0604	6 mm	4 mm	£3.83	£3.43



PG-C
REDUCER

3700

PART NUMBER	TUBE OD (A)	TUBE OD (B)	PRICE EACH	
			1 - 9	10 +
CDPG-C0403	4 mm	3 mm	£2.27	£2.03
CDPG-C0603	6 mm	3 mm	£2.33	£2.10
CDPG-C0604	6 mm	4 mm	£2.58	£2.30



PY-C
UNION 'Y'

3700

PART NUMBER	TUBE OD	PRICE EACH	
		1 - 9	10 +
CDPY-C03	3 mm	£3.46	£3.09
CDPY-C04	4 mm	£4.13	£3.70
CDPY-C06	6 mm	£4.35	£3.89



PW-C
REDUCER 'Y'

3700

PART NUMBER	TUBE OD (A)	TUBE OD (B)	PRICE EACH	
			1 - 9	10 +
CDPW-C0403	4 mm	3 mm	£4.13	£3.70
CDPW-C0603	6 mm	3 mm	£4.51	£4.03
CDPW-C0604	6 mm	4 mm	£4.74	£4.24



PP-C
PLUG

3700

PART NUMBER	TUBE OD	PRICE EACH	
		1 - 9	10 +
CDPP-C03	3 mm	£1.72	£1.54

FEATURES

- Accurate regulation of an optimal airflow rate for precise motion control
- Tube direction and angle are controlled according to piping, as the main body can rotate up to 360° after assembly
- Needle rotation is increased to 10-12 times for easy speed and regular speed control
- Easy speed control with drive tools in limited and crowded spaces NSC (D) and NSC (DC) types
- Miniaturised products occupy small space attaching to devices

APPLICATIONS

- A valve to control the speed of the air pressure actuator
- Mainly installed in the air actuator

SPECIFICATIONS

Fluid type	Air (No other type of gas or liquid)
Working pressure	0 to 150 psi (10.2 bar)
Negative pressure	-29.5 in Hg -750 mm Hg (-750 Torr)
Working temperature	0°C to +60°C (+32°F to +140°F)

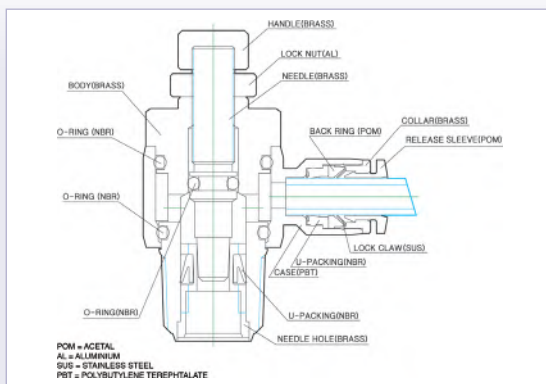

METRIC TUBE TO THREAD



NSC – SWIVEL ROTATING ELBOW

3700



NSC-G – SWIVEL ROTATING ELBOW

3700

PART NUMBER	TUBE OD	THREAD	PRICE EACH	
			1 - 9	10 +
CDNSC03M5N	3 mm	M5 x 0.8	£7.89	£7.06
CDNSC04M5N	4 mm	M5 x 0.8	£8.17	£7.31
CDNSC0401N	4 mm	1/8" BSPT	£9.35	£8.37
CDNSC0402N	4 mm	1/4" BSPT	£9.81	£8.77
CDNSC06M5N	6 mm	M5 x 0.8	£8.19	£7.32
CDNSC0601N	6 mm	1/8" BSPT	£9.45	£8.44
CDNSC0602N	6 mm	1/4" BSPT	£9.79	£8.75
CDNSC0603N	6 mm	3/8" BSPT	£12.19	£10.89
CDNSC0604N	6 mm	1/2" BSPT	£17.50	£15.64
CDNSC0801N	8 mm	1/8" BSPT	£10.11	£9.03
CDNSC0802N	8 mm	1/4" BSPT	£10.11	£9.04
CDNSC0803N	8 mm	3/8" BSPT	£12.17	£10.87
CDNSC0804N	8 mm	1/2" BSPT	£16.81	£15.03
CDNSC1001N	10 mm	1/8" BSPT	£11.21	£10.02
CDNSC1002N	10 mm	1/4" BSPT	£12.54	£11.21
CDNSC1003N	10 mm	3/8" BSPT	£12.57	£11.24
CDNSC1004N	10 mm	1/2" BSPT	£18.14	£16.22
CDNSC1202N	12 mm	1/4" BSPT	£18.25	£16.31
CDNSC1203N	12 mm	3/8" BSPT	£18.28	£16.34
CDNSC1204N	12 mm	1/2" BSPT	£18.40	£16.45

PART NUMBER	TUBE OD	THREAD	PRICE EACH	
			1 - 9	10 +
CDNSC04G1	4 mm	1/8" BSPP	£9.35	£8.37
CDNSC04G2	4 mm	1/4" BSPP	£9.81	£8.77
CDNSC06G1	6 mm	1/8" BSPP	£9.45	£8.44
CDNSC06G2	6 mm	1/4" BSPP	£9.79	£8.75
CDNSC06G3	6 mm	3/8" BSPP	£15.75	£14.08
CDNSC06G4	6 mm	1/2" BSPP	£17.50	£15.64
CDNSC08G1	8 mm	1/8" BSPP	£10.11	£9.03
CDNSC08G2	8 mm	1/4" BSPP	£10.11	£9.04
CDNSC08G3	8 mm	3/8" BSPP	£12.17	£10.87
CDNSC08G4	8 mm	1/2" BSPP	£16.81	£15.03
CDNSC10G1	10 mm	1/8" BSPP	£11.21	£10.02
CDNSC10G2	10 mm	1/4" BSPP	£12.54	£11.21
CDNSC10G3	10 mm	3/8" BSPP	£12.57	£11.24
CDNSC10G4	10 mm	1/2" BSPP	£18.14	£16.22
CDNSC12G2	12 mm	1/4" BSPP	£18.25	£16.31
CDNSC12G3	12 mm	3/8" BSPP	£18.28	£16.34
CDNSC12G4	12 mm	1/2" BSPP	£18.40	£16.45

Eleven

METER-OUT METHOD CONTROL (PREFERRED FOR CYLINDERS)

This product controls the air on the outlet to the tubing and allows free flow through the threaded port.

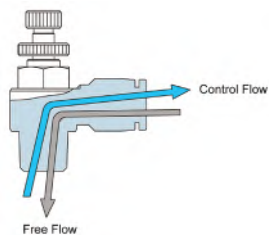

IMPERIAL THREAD TO THREAD

NSCF – SWIVEL ROTATING METAL BODY ELBOW



3700

PART NUMBER	MALE THREAD	FEMALE THREAD	PRICE EACH	
			1 - 9	10 +
CDNSCF01	1/8"	1/8"	£15.70	£14.03
CDNSCF02	1/4"	1/4"	£20.08	£17.94
CDNSCF03	3/8"	3/8"	£26.45	£23.64
CDNSCF04	1/2"	1/2"	£35.34	£31.60

METRIC TUBE TO THREAD



3700

**NSS – SWIVEL ROTATING
IN-LINE**

PART NUMBER	TUBE OD	THREAD	PRICE EACH	
			1 - 9	10 +
CDNSS04M5	4 mm	M5 x 0.8	£8.98	£8.03
CDNSS0401	4 mm	1/8" BSPT	£10.29	£9.20
CDNSS0402	4 mm	1/4" BSPT	£10.80	£9.65
CDNSS06M5	6 mm	M5 x 0.8	£9.00	£8.04
CDNSS0601	6 mm	1/8" BSPT	£10.38	£9.28
CDNSS0602	6 mm	1/4" BSPT	£10.77	£9.62
CDNSS0603	6 mm	3/8" BSPT	£13.41	£11.99
CDNSS0801	8 mm	1/8" BSPT	£11.12	£9.94
CDNSS0802	8 mm	1/4" BSPT	£11.12	£9.95
CDNSS0803	8 mm	3/8" BSPT	£13.39	£11.98
CDNSS0804	8 mm	1/2" BSPT	£18.50	£16.53
CDNSS1002	10 mm	1/4" BSPT	£13.78	£12.33
CDNSS1003	10 mm	3/8" BSPT	£13.83	£12.36
CDNSS1004	10 mm	1/2" BSPT	£19.96	£17.84
CDNSS1202	12 mm	1/4" BSPT	£20.07	£17.93
CDNSS1203	12 mm	3/8" BSPT	£20.10	£17.98
CDNSS1204	12 mm	1/2" BSPT	£20.24	£18.09



3700

**NSS-G – SWIVEL ROTATING
IN-LINE**

PART NUMBER	TUBE OD	THREAD	PRICE EACH	
			1 - 9	10 +
CDNSS04G1	4 mm	1/8" BSPP	£10.29	£9.20
CDNSS04G2	4 mm	1/4" BSPP	£10.80	£9.65
CDNSS06G1	6 mm	1/8" BSPP	£10.38	£9.28
CDNSS06G2	6 mm	1/4" BSPP	£10.77	£9.62
CDNSS06G3	6 mm	3/8" BSPP	£17.32	£15.49
CDNSS08G1	8 mm	1/8" BSPP	£11.12	£9.94
CDNSS08G2	8 mm	1/4" BSPP	£11.12	£9.95
CDNSS08G3	8 mm	3/8" BSPP	£13.39	£11.98
CDNSS08G4	8 mm	1/2" BSPP	£18.50	£16.53
CDNSS10G2	10 mm	1/4" BSPP	£13.78	£12.33
CDNSS10G3	10 mm	3/8" BSPP	£13.83	£12.36
CDNSS10G4	10 mm	1/2" BSPP	£19.96	£17.84
CDNSS12G2	12 mm	1/4" BSPP	£20.07	£17.93
CDNSS12G3	12 mm	3/8" BSPP	£20.10	£17.98
CDNSS12G4	12 mm	1/2" BSPP	£20.24	£18.09



3700

**NSS(D) – SWIVEL ROTATING
ELBOW**

PART NUMBER	TUBE OD	THREAD	PRICE EACH	
			1 - 9	10 +
CDNSC03M5D	3 mm	M5 x 0.8	£7.89	£7.06
CDNSC04M5D	4 mm	M5 x 0.8	£8.17	£7.31
CDNSC0401D	4 mm	1/8" BSPT	£9.35	£8.37
CDNSC0402D	4 mm	1/4" BSPT	£9.81	£8.77
CDNSC06M5D	6 mm	M5 x 0.8	£8.19	£7.32
CDNSC0601D	6 mm	1/8" BSPT	£9.45	£8.44
CDNSC0602D	6 mm	1/4" BSPT	£9.79	£8.75
CDNSC0603D	6 mm	3/8" BSPT	£12.19	£10.89
CDNSC0604D	6 mm	1/2" BSPT	£17.50	£15.64
CDNSC0801D	8 mm	1/8" BSPT	£10.11	£9.03
CDNSC0802D	8 mm	1/4" BSPT	£10.11	£9.04
CDNSC0803D	8 mm	3/8" BSPT	£12.17	£10.87
CDNSC0804D	8 mm	1/2" BSPT	£16.81	£15.03
CDNSC1001D	10 mm	1/8" BSPT	£11.21	£10.02
CDNSC1002D	10 mm	1/4" BSPT	£12.54	£11.21
CDNSC1003D	10 mm	3/8" BSPT	£12.57	£11.24
CDNSC1004D	10 mm	1/2" BSPT	£18.14	£16.22
CDNSC1202D	12 mm	1/4" BSPT	£18.25	£16.31
CDNSC1203D	12 mm	3/8" BSPT	£18.28	£16.34
CDNSC1204D	12 mm	1/2" BSPT	£18.40	£16.45



3700

**NSS-G(D) – SWIVEL ROTATING
ELBOW**

PART NUMBER	TUBE OD	THREAD	PRICE EACH	
			1 - 9	10 +
CDNSC04G1D	4 mm	1/8" BSPP	£9.35	£8.37
CDNSC04G2D	4 mm	1/4" BSPP	£9.81	£8.77
CDNSC06G1D	6 mm	1/8" BSPP	£9.45	£8.44
CDNSC06G2D	6 mm	1/4" BSPP	£9.79	£8.75
CDNSC06G3D	6 mm	3/8" BSPP	£15.75	£14.08
CDNSC06G4D	6 mm	1/2" BSPP	£17.50	£15.64
CDNSC08G1D	8 mm	1/8" BSPP	£10.11	£9.03
CDNSC08G2D	8 mm	1/4" BSPP	£10.11	£9.04
CDNSC08G3D	8 mm	3/8" BSPP	£12.17	£10.87
CDNSC08G4D	8 mm	1/2" BSPP	£16.81	£15.03
CDNSC10G1D	10 mm	1/8" BSPP	£11.21	£10.02
CDNSC10G2D	10 mm	1/4" BSPP	£12.54	£11.21
CDNSC10G3D	10 mm	3/8" BSPP	£12.57	£11.24
CDNSC10G4D	10 mm	1/2" BSPP	£18.14	£16.22
CDNSC12G2D	12 mm	1/4" BSPP	£18.25	£16.31
CDNSC12G3D	12 mm	3/8" BSPP	£18.28	£16.34
CDNSC12G4D	12 mm	1/2" BSPP	£18.40	£16.45

METRIC TUBE TO THREAD



3700

**NSS(D) – SWIVEL ROTATING
IN-LINE**

PART NUMBER	TUBE OD	THREAD	PRICE EACH	
			1 - 9	10 +
CDNSS04M5D	4 mm	M5 x 0.8	£8.98	£8.03
CDNSS0401D	4 mm	1/8" BSPT	£10.29	£9.20
CDNSS0402D	4 mm	1/4" BSPT	£10.80	£9.65
CDNSS06M5D	6 mm	M5 x 0.8	£9.00	£8.04
CDNSS0601D	6 mm	1/8" BSPT	£10.38	£9.28
CDNSS0602D	6 mm	1/4" BSPT	£10.77	£9.62
CDNSS0603D	6 mm	3/8" BSPT	£13.41	£11.99
CDNSS0801D	8 mm	1/8" BSPT	£11.12	£9.94
CDNSS0802D	8 mm	1/4" BSPT	£11.12	£9.95
CDNSS0803D	8 mm	3/8" BSPT	£13.39	£11.98
CDNSS0804D	8 mm	1/2" BSPT	£18.50	£16.53
CDNSS1002D	10 mm	1/4" BSPT	£13.78	£12.33
CDNSS1003D	10 mm	3/8" BSPT	£13.83	£12.36
CDNSS1004D	10 mm	1/2" BSPT	£19.96	£17.84
CDNSS1202D	12 mm	1/4" BSPT	£20.07	£17.93
CDNSS1203D	12 mm	3/8" BSPT	£20.10	£17.98
CDNSS1204D	12 mm	1/2" BSPT	£20.24	£18.09



3700

**NSS-G(D) – SWIVEL ROTATING
IN-LINE**

PART NUMBER	TUBE OD	THREAD	PRICE EACH	
			1 - 9	10 +
CDNSS04G1D	4 mm	1/8" BSPP	£10.29	£9.20
CDNSS04G2D	4 mm	1/4" BSPP	£10.80	£9.65
CDNSS06G1D	6 mm	1/8" BSPP	£10.38	£9.28
CDNSS06G2D	6 mm	1/4" BSPP	£10.77	£9.62
CDNSS06G3D	6 mm	3/8" BSPP	£17.32	£15.49
CDNSS08G1D	8 mm	1/8" BSPP	£11.12	£9.94
CDNSS08G2D	8 mm	1/4" BSPP	£11.12	£9.95
CDNSS08G3D	8 mm	3/8" BSPP	£13.39	£11.98
CDNSS08G4D	8 mm	1/2" BSPP	£18.50	£16.53
CDNSS10G2D	10 mm	1/4" BSPP	£13.78	£12.33
CDNSS10G3D	10 mm	3/8" BSPP	£13.83	£12.36
CDNSS10G4D	10 mm	1/2" BSPP	£19.96	£17.84
CDNSS12G2D	12 mm	1/4" BSPP	£20.07	£17.93
CDNSS12G3D	12 mm	3/8" BSPP	£20.10	£17.98
CDNSS12G4D	12 mm	1/2" BSPP	£20.24	£18.09

Elevan



3700

**NSC(DC) – SWIVEL ROTATING
ELBOW**

PART NUMBER	TUBE OD	THREAD	PRICE EACH	
			1 - 9	10 +
CDNSC03M5DC	3 mm	M5 x 0.8	£8.68	£7.76
CDNSC04M5DC	4 mm	M5 x 0.8	£8.98	£8.03
CDNSC0401DC	4 mm	1/8" BSPT	£10.29	£9.20
CDNSC0402DC	4 mm	1/4" BSPT	£10.80	£9.65
CDNSC06M5DC	6 mm	M5 x 0.8	£9.00	£8.04
CDNSC0601DC	6 mm	1/8" BSPT	£10.38	£9.28
CDNSC0602DC	6 mm	1/4" BSPT	£10.77	£9.62
CDNSC0603DC	6 mm	3/8" BSPT	£13.41	£11.99
CDNSC0604DC	6 mm	1/2" BSPT	£19.24	£17.21
CDNSC0801DC	8 mm	1/8" BSPT	£11.12	£9.94
CDNSC0802DC	8 mm	1/4" BSPT	£11.12	£9.95
CDNSC0803DC	8 mm	3/8" BSPT	£13.39	£11.98
CDNSC0804DC	8 mm	1/2" BSPT	£18.50	£16.53
CDNSC1001DC	10 mm	1/8" BSPT	£12.33	£11.03
CDNSC1002DC	10 mm	1/4" BSPT	£13.80	£12.33
CDNSC1003DC	10 mm	3/8" BSPT	£13.83	£12.36
CDNSC1004DC	10 mm	1/2" BSPT	£19.96	£17.84
CDNSC1202DC	12 mm	1/4" BSPT	£20.07	£17.93
CDNSC1203DC	12 mm	3/8" BSPT	£20.10	£17.98
CDNSC1204DC	12 mm	1/2" BSPT	£20.24	£18.09



3700

**NSC-G(DC) – SWIVEL ROTATING
ELBOW**

PART NUMBER	TUBE OD	THREAD	PRICE EACH	
			1 - 9	10 +
CDNSC04G1DC	4 mm	1/8" BSPP	£10.29	£9.20
CDNSC04G2DC	4 mm	1/4" BSPP	£10.80	£9.65
CDNSC06G1DC	6 mm	1/8" BSPP	£10.39	£9.29
CDNSC06G2DC	6 mm	1/4" BSPP	£10.77	£9.62
CDNSC06G3DC	6 mm	3/8" BSPP	£17.33	£15.49
CDNSC06G4DC	6 mm	1/2" BSPP	£19.24	£17.21
CDNSC08G1DC	8 mm	1/8" BSPP	£11.12	£9.94
CDNSC08G2DC	8 mm	1/4" BSPP	£11.12	£9.95
CDNSC08G3DC	8 mm	3/8" BSPP	£13.39	£11.98
CDNSC08G4DC	8 mm	1/2" BSPP	£18.50	£16.53
CDNSC10G1DC	10 mm	1/8" BSPP	£12.33	£11.03
CDNSC10G2DC	10 mm	1/4" BSPP	£13.78	£12.33
CDNSC10G3DC	10 mm	3/8" BSPP	£13.83	£12.36
CDNSC10G4DC	10 mm	1/2" BSPP	£19.96	£17.84
CDNSC12G2DC	12 mm	1/4" BSPP	£20.07	£17.93
CDNSC12G3DC	12 mm	3/8" BSPP	£20.10	£17.98
CDNSC12G4DC	12 mm	1/2" BSPP	£20.24	£18.09

METRIC TUBE TO THREAD



NSS(DC) – SWIVEL ROTATING IN-LINE

3700



NSS-G(DC) – SWIVEL ROTATING IN-LINE

3700

PART NUMBER	TUBE OD	THREAD	PRICE EACH	
			1 - 9	10 +
CDNSS04M5DC	4 mm	M5 x 0.8	£9.88	£8.83
CDNSS0401DC	4 mm	1/8" BSPT	£11.32	£10.12
CDNSS0402DC	4 mm	1/4" BSPT	£11.87	£10.61
CDNSS06M5DC	6 mm	M5 x 0.8	£9.91	£8.86
CDNSS0601DC	6 mm	1/8" BSPT	£11.42	£10.21
CDNSS0602DC	6 mm	1/4" BSPT	£11.84	£10.58
CDNSS0603DC	6 mm	3/8" BSPT	£14.75	£13.18
CDNSS0801DC	8 mm	1/8" BSPT	£12.22	£10.94
CDNSS0802DC	8 mm	1/4" BSPT	£12.25	£10.95
CDNSS0803DC	8 mm	3/8" BSPT	£14.73	£13.17
CDNSS0804DC	8 mm	1/2" BSPT	£20.35	£18.19
CDNSS1002DC	10 mm	1/4" BSPT	£15.17	£13.56
CDNSS1003DC	10 mm	3/8" BSPT	£15.20	£13.59
CDNSS1004DC	10 mm	1/2" BSPT	£21.95	£19.62
CDNSS1202DC	12 mm	1/4" BSPT	£22.07	£19.73
CDNSS1203DC	12 mm	3/8" BSPT	£22.12	£19.76
CDNSS1204DC	12 mm	1/2" BSPT	£22.26	£19.90

PART NUMBER	TUBE OD	THREAD	PRICE EACH	
			1 - 9	10 +
CDNSS04G1DC	4 mm	1/8" BSPP	£11.32	£10.12
CDNSS04G2DC	4 mm	1/4" BSPP	£11.87	£10.61
CDNSS06G1DC	6 mm	1/8" BSPP	£11.42	£10.21
CDNSS06G2DC	6 mm	1/4" BSPP	£11.84	£10.58
CDNSS06G3DC	6 mm	3/8" BSPP	£19.06	£17.03
CDNSS08G1DC	8 mm	1/8" BSPP	£12.22	£10.94
CDNSS08G2DC	8 mm	1/4" BSPP	£12.25	£10.95
CDNSS08G3DC	8 mm	3/8" BSPP	£14.73	£13.17
CDNSS08G4DC	8 mm	1/2" BSPP	£20.35	£18.19
CDNSS10G2DC	10 mm	1/4" BSPP	£15.17	£13.56
CDNSS10G3DC	10 mm	3/8" BSPP	£15.20	£13.59
CDNSS10G4DC	10 mm	1/2" BSPP	£21.95	£19.62
CDNSS12G2DC	12 mm	1/4" BSPP	£22.07	£19.73
CDNSS12G3DC	12 mm	3/8" BSPP	£22.12	£19.76
CDNSS12G4DC	12 mm	1/2" BSPP	£22.26	£19.90

METRIC TUBE TO TUBE



NSF STRAIGHT UNION

3700

PART NUMBER	TUBE OD	PRICE EACH	
		1 - 9	10 +
CDNSF04N	4 mm	£10.21	£9.13
CDNSF06N	6 mm	£11.77	£10.52
CDNSF08N	8 mm	£13.46	£12.04
CDNSF10N	10 mm	£15.03	£13.44
CDNSF12N	12 mm	£16.81	£15.02

IMPERIAL TUBE TO TUBE



NSF STRAIGHT UNION

3700

PART NUMBER	TUBE OD	PRICE EACH	
		1 - 9	10 +
CDNSF1/4	1/4"	£14.11	£12.61
CDNSF3/8	3/8"	£18.05	£16.14
CDNSF1/2	1/2"	£20.17	£18.03



NSFB STRAIGHT BULKHEAD UNION

3700

PART NUMBER	TUBE OD	TUBE OD	PRICE EACH	
			1 - 9	10 +
CDNSFB04N	4 mm	4 mm	£12.89	£11.53
CDNSFB06N	6 mm	6 mm	£14.99	£13.40
CDNSFB08N	8 mm	8 mm	£18.61	£16.63
CDNSFB10N	10 mm	10 mm	£22.94	£20.50
CDNSFB12N	12 mm	12 mm	£27.39	£24.49

Eleven

FEATURES

- Combined pilot check valve and speed controller
- Enables 360° free direction of tubing mount

APPLICATIONS

- Realises momentary intermediate stoppage of a cylinder and able to adjust speed control of it

SPECIFICATIONS

Fluid type	Air (No other type of gas or liquid)
Working pressure	1.4 to 150 psi (10.2 bar)
Negative pressure	-29.5 in Hg / -750 mm Hg (-750 Torr)
Working temperature	0°C to +60°C (+32°F to +140°F)
Application tube	Polyurethane and nylon

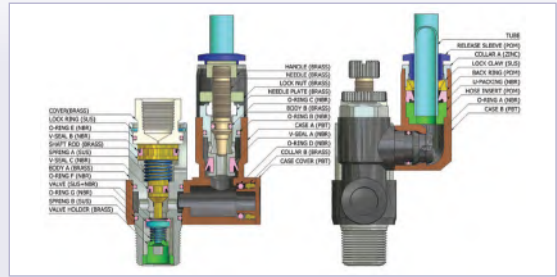

TUBE TO THREAD



3700

PVSC – SWIVEL ROTATING WITH PILOT CHECK VALVE

PART NUMBER	TUBE OD	THREAD	PRICE EACH	
			1 - 9	10 +
CDPVSC0601	6 mm	1/8" BSPT	£55.16	£49.31
CDPVSC0602	6 mm	1/4" BSPT	£65.40	£58.46
CDPVSC0801	8 mm	1/8" BSPT	£55.17	£49.32
CDPVSC0802	8 mm	1/4" BSPT	£65.41	£58.47
CDPVSC0803	8 mm	3/8" BSPT	£77.51	£69.29
CDPVSC1003	10 mm	3/8" BSPT	£77.57	£69.34
CDPVSC1004	10 mm	1/2" BSPT	£102.75	£91.85
CDPVSC1203	12 mm	3/8" BSPT	£77.69	£69.46
CDPVSC1204	12 mm	1/2" BSPT	£102.87	£91.96



3700

PVSC-G – SWIVEL ROTATING WITH PILOT CHECK VALVE

PART NUMBER	TUBE OD	THREAD	PRICE EACH	
			1 - 9	10 +
CDPVSC06G1	6 mm	1/8" BSPP	£57.92	£51.78
CDPVSC06G2	6 mm	1/4" BSPP	£68.67	£61.39
CDPVSC08G1	8 mm	1/8" BSPP	£57.93	£51.79
CDPVSC08G2	8 mm	1/4" BSPP	£68.68	£61.40
CDPVSC08G3	8 mm	3/8" BSPP	£81.38	£72.75
CDPVSC10G3	10 mm	3/8" BSPP	£81.45	£72.80
CDPVSC10G4	10 mm	1/2" BSPP	£107.88	£96.44
CDPVSC12G3	12 mm	3/8" BSPP	£81.57	£72.93
CDPVSC12G4	12 mm	1/2" BSPP	£108.02	£96.56

Eleven

SILENCERS

FEATURES

- Made from corrosion resistant plastic
- Competitively priced, lightweight and durable
- Very compact, can be easily installed in limited spaces

APPLICATIONS

- Installed at exhaust ports to diminish ventilation noise

SPECIFICATIONS	1/8", 1/4", 3/8"	1/2", 3/4", 1"
Max. working pressure	100 psi (6.9 bar)	150 psi (10.2 bar)

FEATURES

- Excellent noise reduction and filtering effect in dry conditions

APPLICATIONS

- Metal filters are available for high temperature and pressure environments
- Durable against impact
- Easy to weld and used for virtually every industry

SPECIFICATIONS	M5	1/8"	1/4"	3/8"	1/2"	3/4"	1"
Flow rate	250	300	320	340	370	400	420
Max. working pressure	220 psi (15.1 bar)						
Working temperature	0°C – 80°C (+32°F to 176°F)						



3700

ST PLASTIC

PART NUMBER	OD	THREAD	PRICE EACH	
			1 - 9	10 +
CDST-01	10.5 mm	1/8" BSPT	£2.24	£2.00
CDST-02	22.2 mm	1/4" BSPT	£2.80	£2.50
CDST-03	25.0 mm	3/8" BSPT	£3.37	£3.02
CDST-04	30.0 mm	1/2" BSPT	£3.97	£3.54
CDST-06	45.0 mm	3/4" BSPT	£27.41	£24.51
CDST-08	45.0 mm	1" BSPT	£27.41	£24.51



3700

STB SINTERED BRASS

PART NUMBER	THREAD	PRICE EACH	
		1 - 9	10 +
CDSTB-M5	M5 x 0.8	£1.03	£0.93
CDSTB-01	1/8" BSPT	£1.42	£1.27
CDSTB-02	1/4" BSPT	£2.25	£2.02
CDSTB-03	3/8" BSPT	£4.13	£3.70
CDSTB-04	1/2" BSPT	£5.67	£5.07
CDSTB-06	3/4" BSPT	£12.38	£11.07
CDSTB-08	1" BSPT	£21.92	£19.60

FEATURES

- This product switches compressed air on / off on air pressure devices by simply turning the handle
- Maintenance or inspection is possible when the remaining pressure in the device is removed
- A three-way valve discharges the remaining pressure out, and blocks the incoming air in the off state
- Four types available depending on the method applied to air pressure flow

APPLICATIONS

- Used for switching compressed air

SPECIFICATIONS

Fluid type	Air (No other type of gas or liquid)
Working pressure	0 to 150 psi (10.2 bar)
Negative pressure	-29.5 in Hg / -750 mm Hg (-750 Torr)
Working temperature	0°C to +60°C (+32°F to +140°F)
Application tube	Polyurethane and nylon

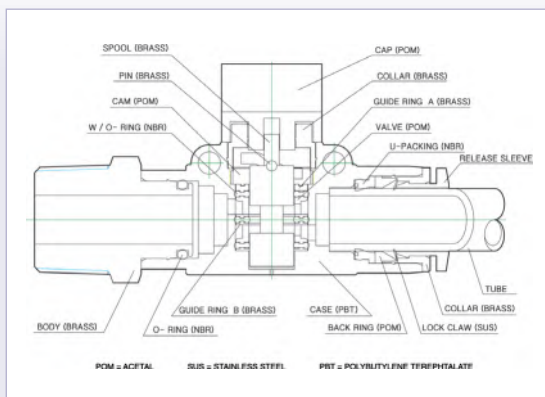

TUBE TO THREAD



3700

HVC
STRAIGHT 'A' VALVE

PART NUMBER	TUBE OD	THREAD	PRICE EACH	
			1 - 9	10 +
CDHVC0401	4 mm	1/8" BSPT	£9.91	£8.86
CDHVC0402	4 mm	1/4" BSPT	£10.29	£9.20
CDHVC0403	4 mm	3/8" BSPT	£10.68	£9.54
CDHVC0601	6 mm	1/8" BSPT	£9.91	£8.86
CDHVC0602	6 mm	1/4" BSPT	£10.29	£9.20
CDHVC0603	6 mm	3/8" BSPT	£10.68	£9.54
CDHVC0801	8 mm	1/8" BSPT	£10.68	£9.54
CDHVC0802	8 mm	1/4" BSPT	£11.05	£9.87
CDHVC0803	8 mm	3/8" BSPT	£11.43	£10.22
CDHVC1002	10 mm	1/4" BSPT	£11.43	£10.22
CDHVC1003	10 mm	3/8" BSPT	£11.81	£10.56
CDHVC1004	10 mm	1/2" BSPT	£12.27	£10.97
CDHVC1202	12 mm	1/4" BSPT	£12.27	£10.97
CDHVC1203	12 mm	3/8" BSPT	£12.57	£11.24
CDHVC1204	12 mm	1/2" BSPT	£12.95	£11.58



3700

HVC-G
STRAIGHT 'A' VALVE

PART NUMBER	TUBE OD	THREAD	PRICE EACH	
			1 - 9	10 +
CDHVC04G01	4 mm	1/8" BSPP	£9.91	£8.86
CDHVC04G02	4 mm	1/4" BSPP	£10.29	£9.20
CDHVC04G03	4 mm	3/8" BSPP	£10.68	£9.54
CDHVC06G01	6 mm	1/8" BSPP	£9.91	£8.86
CDHVC06G02	6 mm	1/4" BSPP	£10.29	£9.20
CDHVC06G03	6 mm	3/8" BSPP	£10.68	£9.54
CDHVC08G01	8 mm	1/8" BSPP	£10.68	£9.54
CDHVC08G02	8 mm	1/4" BSPP	£11.05	£9.87
CDHVC08G03	8 mm	3/8" BSPP	£11.43	£10.22
CDHVC10G02	10 mm	1/4" BSPP	£11.43	£10.22
CDHVC10G03	10 mm	3/8" BSPP	£11.81	£10.56
CDHVC10G04	10 mm	1/2" BSPP	£12.27	£10.97
CDHVC12G02	12 mm	1/4" BSPP	£12.27	£10.97
CDHVC12G03	12 mm	3/8" BSPP	£12.57	£11.24
CDHVC12G04	12 mm	1/2" BSPP	£12.95	£11.58



3700

HVF
STRAIGHT 'B' VALVE

PART NUMBER	THREAD	TUBE OD	PRICE EACH	
			1 - 9	10 +
CDHVF0104	1/8" BSPT	4 mm	£9.91	£8.86
CDHVF0204	1/4" BSPT	4 mm	£10.68	£9.54
CDHVF0304	3/8" BSPT	4 mm	£11.43	£10.22
CDHVF0106	1/8" BSPT	6 mm	£9.91	£8.86
CDHVF0206	1/4" BSPT	6 mm	£10.68	£9.54
CDHVF0306	3/8" BSPT	6 mm	£11.43	£10.22
CDHVF0108	1/8" BSPT	8 mm	£10.29	£9.20
CDHVF0208	1/4" BSPT	8 mm	£10.68	£9.54
CDHVF0308	3/8" BSPT	8 mm	£11.81	£10.56
CDHVF0210	1/4" BSPT	10 mm	£11.05	£9.87
CDHVF0310	3/8" BSPT	10 mm	£12.27	£10.97
CDHVF0410	1/2" BSPT	10 mm	£12.57	£11.24
CDHVF0212	1/4" BSPT	12 mm	£11.43	£10.22
CDHVF0312	3/8" BSPT	12 mm	£12.27	£10.97
CDHVF0412	1/2" BSPT	12 mm	£12.95	£11.58



3700

HVF-G
STRAIGHT 'B' VALVE

PART NUMBER	THREAD	TUBE OD	PRICE EACH	
			1 - 9	10 +
CDHVFG0104	1/8" BSPP	4 mm	£9.91	£8.86
CDHVFG0204	1/4" BSPP	4 mm	£10.68	£9.54
CDHVFG0304	3/8" BSPP	4 mm	£11.43	£10.22
CDHVFG0106	1/8" BSPP	6 mm	£9.91	£8.86
CDHVFG0206	1/4" BSPP	6 mm	£10.68	£9.54
CDHVFG0306	3/8" BSPP	6 mm	£11.43	£10.22
CDHVFG0108	1/8" BSPP	8 mm	£10.29	£9.20
CDHVFG0208	1/4" BSPP	8 mm	£10.68	£9.54
CDHVFG0308	3/8" BSPP	8 mm	£11.81	£10.56
CDHVFG0210	1/4" BSPP	10 mm	£11.05	£9.87
CDHVFG0310	3/8" BSPP	10 mm	£12.27	£10.97
CDHVFG0410	1/2" BSPP	10 mm	£12.57	£11.24
CDHVFG0212	1/4" BSPP	12 mm	£11.43	£10.22
CDHVFG0312	3/8" BSPP	12 mm	£12.27	£10.97
CDHVFG0412	1/2" BSPP	12 mm	£12.95	£11.58

BSPT THREAD HAND VALVES



HVM
NIPPLE VALVE

3700

PART NUMBER	THREAD (A)	THREAD (B)	PRICE EACH	
			1 - 9	10 +
CDHVM0101	1/8" BSPT	1/8" BSPT	£10.68	£9.54
CDHVM0201	1/4" BSPT	1/8" BSPT	£11.43	£10.22
CDHVM0202	1/4" BSPT	1/4" BSPT	£12.27	£10.97
CDHVM0302	3/8" BSPT	1/4" BSPT	£12.95	£11.58
CDHVM0303	3/8" BSPT	3/8" BSPT	£13.72	£12.27
CDHVM0403	1/2" BSPT	3/8" BSPT	£14.48	£12.94
CDHVM0404	1/2" BSPT	1/2" BSPT	£15.24	£13.63



HSV
HAND SLIDE VALVE

3700

PART NUMBER	THREAD	PRICE EACH	
		1 - 9	10 +
CDHSVM-M5	M5 x 0.8	£9.54	£8.53
CDHSVM-01	1/8" BSPT	£12.19	£10.90
CDHSVM-02	1/4" BSPT	£20.85	£18.64
CDHSVM-03	3/8" BSPT	£37.22	£33.26
CDHSVM-04	1/2" BSPT	£40.11	£35.85
CDHSVM-06	3/4" BSPT	£51.09	£45.67

METRIC TUBE TO TUBE

To insert the tube into the fitting, insert it fully to the end, and to release, shut off the compressed air and push the sleeve gently to pull the tube out.

Be sure to select the product according to your needs, as hand valves vent the downstream line using a three-way method so leakage may occur when fluids other than air are applied.

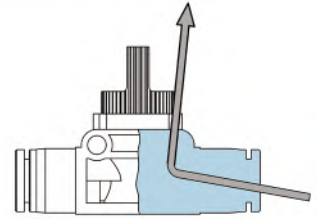

BSPP THREAD



HVV
STRAIGHT UNION VALVE

3700

PART NUMBER	TUBE OD (A)	TUBE OD (B)	PRICE EACH	
			1 - 9	10 +
CDHVU0404	4 mm	4 mm	£9.15	£8.18
CDHVU0606	6 mm	6 mm	£9.15	£8.18
CDHVU0806	8 mm	6 mm	£9.91	£8.86
CDHVU0808	8 mm	8 mm	£9.91	£8.86
CDHVU1008	10 mm	8 mm	£10.68	£9.54
CDHVU1010	10 mm	10 mm	£10.68	£9.54
CDHVU1210	12 mm	10 mm	£11.43	£10.22
CDHVU1212	12 mm	12 mm	£11.43	£10.22

HAND BALL VALVES

New



HBVU
IMPERIAL HAND BALL VALVE

3720

PART NUMBER	TUBE OD	PRICE EACH	
		1 - 9	10 +
CDHBVU1/4-1/4	1/4"	£5.83	£5.11
CDHBVU5/16-5/16	5/16"	£5.97	£5.24
CDHBVU3/8-3/8	3/8"	£6.35	£5.57
CDHBVU1/2-1/2	1/2"	£6.56	£5.75



HBVU
METRIC HAND BALL VALVE

3720

PART NUMBER	TUBE OD	PRICE EACH	
		1 - 9	10 +
CDHBVU0606	6 mm	£7.61	£6.80
CDHBVU0808	8 mm	£7.71	£6.90
CDHBVU1010	10 mm	£8.30	£7.42
CDHBVU1212	12 mm	£8.49	£7.60

HVM-G
NIPPLE VALVE

3700

PART NUMBER	THREAD (A)	THREAD (B)	PRICE EACH	
			1 - 9	10 +
CDHVMG0101	1/8" BSPP	1/8" BSPP	£10.68	£9.54
CDHVMG0201	1/4" BSPP	1/8" BSPP	£11.43	£10.22
CDHVMG0202	1/4" BSPP	1/4" BSPP	£12.27	£10.97
CDHVMG0302	3/8" BSPP	1/4" BSPP	£12.95	£11.58
CDHVMG0303	3/8" BSPP	3/8" BSPP	£13.72	£12.27
CDHVMG0403	1/2" BSPP	3/8" BSPP	£14.48	£12.94
CDHVMG0404	1/2" BSPP	1/2" BSPP	£15.24	£13.63



FEATURES

- Air is completely blocked when the tube is released, and the air flows again only after connection, to ensure safety. The air flows only when the tube is connected.

APPLICATIONS

- Used where pneumatic piping frequently changes

SPECIFICATIONS

Fluid type	Air (No other type of gas or liquid)
Working pressure	0 to 150 psi (10.2 bar)
Negative pressure	-29.5 in Hg -750 mm Hg (-750 Torr)
Working temperature	0°C to +60°C (+32°F to +140°F)
Application tube	Polyurethane and nylon

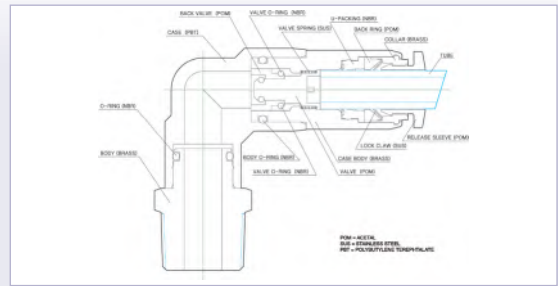

METRIC TUBE TO THREAD



SPC
MALE STRAIGHT

3700

PART NUMBER	TUBE OD	THREAD	PRICE EACH	
			1 - 9	10 +
CDSPC0401	4 mm	1/8" BSPT	£6.80	£6.08
CDSPC0601	6 mm	1/8" BSPT	£6.88	£6.15
CDSPC0602	6 mm	1/4" BSPT	£7.12	£6.37
CDSPC0802	8 mm	1/4" BSPT	£8.02	£7.17
CDSPC0803	8 mm	3/8" BSPT	£9.75	£8.71
CDSPC1002	10 mm	1/4" BSPT	£9.82	£8.78
CDSPC1003	10 mm	3/8" BSPT	£10.07	£9.01
CDSPC1004	10 mm	1/2" BSPT	£11.06	£9.88
CDSPC1202	12 mm	1/4" BSPT	£11.47	£10.25
CDSPC1203	12 mm	3/8" BSPT	£11.70	£10.47
CDSPC1204	12 mm	1/2" BSPT	£12.04	£10.76



SPC-G
MALE STRAIGHT

3700

PART NUMBER	TUBE OD	THREAD	PRICE EACH	
			1 - 9	10 +
CDSPC04G01	4 mm	1/8" BSPP	£6.80	£6.08
CDSPC06G01	6 mm	1/8" BSPP	£6.88	£6.15
CDSPC06G02	6 mm	1/4" BSPP	£7.12	£6.37
CDSPC08G02	8 mm	1/4" BSPP	£8.02	£7.17
CDSPC08G03	8 mm	3/8" BSPP	£9.75	£8.71
CDSPC10G02	10 mm	1/4" BSPP	£9.82	£8.78
CDSPC10G03	10 mm	3/8" BSPP	£10.07	£9.01
CDSPC10G04	10 mm	1/2" BSPP	£11.06	£9.88
CDSPC12G02	12 mm	1/4" BSPP	£11.47	£10.25
CDSPC12G03	12 mm	3/8" BSPP	£11.70	£10.47
CDSPC12G04	12 mm	1/2" BSPP	£12.04	£10.76



SPL
MALE ELBOW

3700

PART NUMBER	TUBE OD	THREAD	PRICE EACH	
			1 - 9	10 +
CDSPL04M5	4 mm	M5 x 0.8	£7.87	£7.04
CDSPL04M6	4 mm	M6 x 1.0	£8.19	£7.32
CDSPL0401	4 mm	1/8" BSPT	£7.37	£6.59
CDSPL06M5	6 mm	M5 x 0.8	£10.43	£9.32
CDSPL0601	6 mm	1/8" BSPT	£7.87	£7.04
CDSPL0602	6 mm	1/4" BSPT	£8.19	£7.32
CDSPL0801	8 mm	1/8" BSPT	£10.43	£9.32
CDSPL0802	8 mm	1/4" BSPT	£10.43	£9.32
CDSPL0803	8 mm	3/8" BSPT	£10.24	£9.16
CDSPL1002	10 mm	1/4" BSPT	£11.54	£10.32
CDSPL1003	10 mm	3/8" BSPT	£11.70	£10.47
CDSPL1004	10 mm	1/2" BSPT	£13.35	£11.93
CDSPL1203	12 mm	3/8" BSPT	£15.97	£14.27
CDSPL1204	12 mm	1/2" BSPT	£16.37	£14.64



SPL-G
MALE ELBOW

3700

PART NUMBER	TUBE OD	THREAD	PRICE EACH	
			1 - 9	10 +
CDSPL04G01	4 mm	1/8" BSPP	£7.37	£6.59
CDSPL06G01	6 mm	1/8" BSPP	£7.87	£7.04
CDSPL06G02	6 mm	1/4" BSPP	£8.19	£7.32
CDSPL08G01	8 mm	1/8" BSPP	£10.43	£9.32
CDSPL08G02	8 mm	1/4" BSPP	£10.43	£9.32
CDSPL08G03	8 mm	3/8" BSPP	£10.24	£9.16
CDSPL10G02	10 mm	1/4" BSPP	£11.54	£10.32
CDSPL10G03	10 mm	3/8" BSPP	£11.70	£10.47
CDSPL10G04	10 mm	1/2" BSPP	£13.35	£11.93
CDSPL12G03	12 mm	3/8" BSPP	£15.97	£14.27
CDSPL12G04	12 mm	1/2" BSPP	£16.37	£14.64

METRIC TUBE TO TUBE

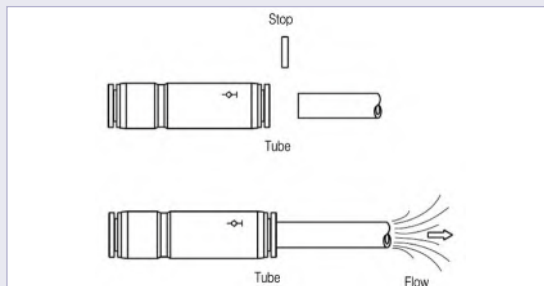

SPU
STRAIGHT STOP UNION

3700

PART NUMBER	TUBE OD	PRICE EACH	
		1 - 9	10 +
CDSPU04	4 mm	£7.37	£6.59
CDSPU06	6 mm	£10.43	£9.32
CDSPU08	8 mm	£9.82	£8.78
CDSPU10	10 mm	£11.06	£9.88
CDSPU12	12 mm	£11.54	£10.32

FEATURES

- Suitable for low pressure applications
- Allows compressed air from one side to flow and blocks the inverse flow to protect and maintain the vacuum line
- Easily applied to low pressure piping

APPLICATIONS

- Used where air should flow in only one direction
- Used where air pressure of the ventilation section should be kept uniform
- Good for low pressure devices

SPECIFICATIONS

Fluid type	Air (No other type of gas or liquid)
Working pressure	0 to 150 psi (10.2 bar)
Negative pressure	-29.5 in Hg -750 mm Hg (-750 Torr)
Working temperature	0°C to +60°C (+32°F to +140°F)
Application tube	Polyurethane and nylon

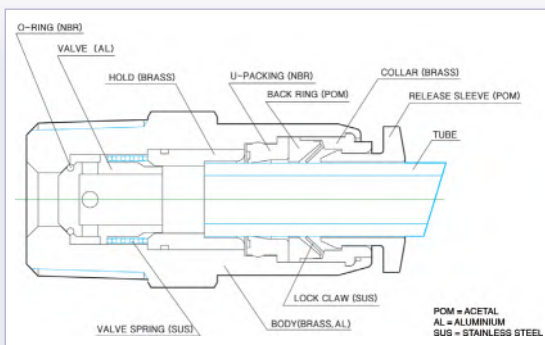

TUBE TO THREAD



**CVPC
MALE STRAIGHT**

3700

PART NUMBER	TUBE OD	THREAD	PRICE EACH	
			1 - 9	10 +
CDCVPC04M5	4 mm	M5 x 0.8	£7.37	£6.59
CDCVPC04M6	4 mm	M6 x 1.0	£7.37	£6.59
CDCVPC0401	4 mm	1/8" BSPT	£7.87	£7.04
CDCVPC0601	6 mm	1/8" BSPT	£10.43	£9.32
CDCVPC0602	6 mm	1/4" BSPT	£10.43	£9.32
CDCVPC0801	8 mm	1/8" BSPT	£9.33	£8.35
CDCVPC0802	8 mm	1/4" BSPT	£9.82	£8.78
CDCVPC1003	10 mm	3/8" BSPT	£20.63	£18.44
CDCVPC1004	10 mm	1/2" BSPT	£21.70	£19.39
CDCVPC1203	12 mm	3/8" BSPT	£21.38	£19.11
CDCVPC1204	12 mm	1/2" BSPT	£22.35	£19.98



**CVPC-G
MALE STRAIGHT**

3700

PART NUMBER	TUBE OD	THREAD	PRICE EACH	
			1 - 9	10 +
CDCVPC04G1	4 mm	1/8" BSPP	£7.87	£7.04
CDCVPC06G1	6 mm	1/8" BSPP	£10.43	£9.32
CDCVPC06G2	6 mm	1/4" BSPP	£10.43	£9.32
CDCVPC08G1	8 mm	1/8" BSPP	£9.33	£8.35
CDCVPC08G2	8 mm	1/4" BSPP	£9.82	£8.78
CDCVPC10G3	10 mm	3/8" BSPP	£20.63	£18.44
CDCVPC10G4	10 mm	1/2" BSPP	£21.70	£19.39
CDCVPC12G3	12 mm	3/8" BSPP	£21.38	£19.11
CDCVPC12G4	12 mm	1/2" BSPP	£22.35	£19.98

METRIC TUBE TO TUBE



**CVPU
STRAIGHT UNION**

3700

PART NUMBER	TUBE OD	PRICE EACH	
		1 - 9	10 +
CDCVPU04	4 mm	£7.87	£7.04
CDCVPU06	6 mm	£10.43	£9.32
CDCVPU08	8 mm	£10.81	£9.67
CDCVPU10	10 mm	£24.32	£21.74
CDCVPU12	12 mm	£25.85	£23.10

THREAD TO THREAD



**CVPF
BUSH**

3700

PART NUMBER	FEMALE THREAD	MALE THREAD	PRICE EACH	
			1 - 9	10 +
CDCVPF0101	1/8" BSPT	1/8" BSPT	£10.43	£9.32
CDCVPF0202	1/4" BSPT	1/4" BSPT	£9.82	£8.78
CDCVPF0303	3/8" BSPT	3/8" BSPT	£10.43	£9.32
CDCVPF0404	1/2" BSPT	1/2" BSPT	£19.40	£17.34



**CVPF-G
BUSH**

3700

PART NUMBER	FEMALE THREAD	MALE THREAD	PRICE EACH	
			1 - 9	10 +
CDCVPF01G1	1/8" BSPP	1/8" BSPP	£10.43	£9.32
CDCVPF02G2	1/4" BSPP	1/4" BSPP	£9.82	£8.78
CDCVPF03G3	3/8" BSPP	3/8" BSPP	£10.43	£9.32
CDCVPF04G4	1/2" BSPP	1/2" BSPP	£19.40	£17.34



**CVFF
STRAIGHT UNION**

3700

PART NUMBER	THREAD	PRICE EACH	
		1 - 9	10 +
CDCVFF01-01	1/8" BSPT	£9.31	£8.32
CDCVFF02-02	1/4" BSPT	£12.35	£11.04
CDCVFF03-03	3/8" BSPT	£18.15	£16.23
CDCVFF04-04	1/2" BSPT	£20.61	£18.42

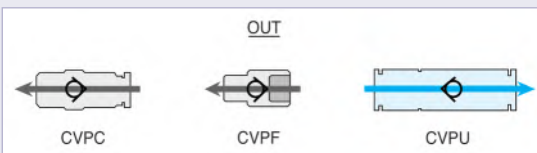

Fitting material aluminium

FEATURES

- The connection method is nut tightening and efficient in environments with vibration
- Made from plastics which have good tolerance to corrosion and chemicals
- Suited for low air pressure devices

APPLICATIONS

- A nut tightening pipe connection tool for devices that use pneumatic piping

SPECIFICATIONS

Fluid type	Air / water & fluid (not suitable for potable water)
Working pressure	0 to 150 psi (10.2 bar)
Negative pressure	-29.5 in Hg -750 mm Hg (-750 Torr)
Working temperature	0°C to +60°C (+32°F to +140°F)
Application tube	Polyurethane tube

METRIC TUBE TO TUBE



FCK
UNION TEE

3700

PART NUMBER	TUBE OD/ID	PRICE EACH	
		1 - 9	10 +
CDFK06	6/4 mm	£2.84	£2.54
CDFK08	8/5.5 mm	£3.05	£2.73
CDFK10	10/6.5 mm	£3.34	£2.99
CDFK12	12/8 mm	£3.67	£3.28

TUBE TO THREAD



CK
MALE STRAIGHT

3700

PART NUMBER	TUBE OD/ID	THREAD	PRICE EACH	
			1 - 9	10 +
CDCK0601	6/4 mm	1/8" BSPT	£1.22	£1.10
CDCK0602	6/4 mm	1/4" BSPT	£1.34	£1.19
CDCK0801	8/5.5 mm	1/8" BSPT	£1.34	£1.19
CDCK0802	8/5.5 mm	1/4" BSPT	£1.65	£1.48
CDCK0803	8/5.5 mm	3/8" BSPT	£1.86	£1.66
CDCK1002	10/6.5 mm	1/4" BSPT	£1.95	£1.74
CDCK1003	10/6.5 mm	3/8" BSPT	£1.95	£1.74
CDCK1202	12/8 mm	1/4" BSPT	£1.95	£1.74
CDCK1203	12/8 mm	3/8" BSPT	£1.95	£1.74



GCK
ELBOW

3700

PART NUMBER	TUBE OD/ID	THREAD	PRICE EACH	
			1 - 9	10 +
CDGCK0601	6/4 mm	1/8" BSPT	£1.65	£1.48
CDGCK0602	6/4 mm	1/4" BSPT	£1.86	£1.66
CDGCK0801	8/5.5 mm	1/8" BSPT	£1.65	£1.48
CDGCK0802	8/5.5 mm	1/4" BSPT	£1.86	£1.66
CDGCK0803	8/5.5 mm	3/8" BSPT	£2.36	£2.11
CDGCK1002	10/6.5 mm	1/4" BSPT	£2.57	£2.30
CDGCK1003	10/6.5 mm	3/8" BSPT	£2.57	£2.30
CDGCK1202	12/8 mm	1/4" BSPT	£2.57	£2.30
CDGCK1203	12/8 mm	3/8" BSPT	£2.57	£2.30

ACCESSORIES

SPECIFICATIONS

Temperature range	0°C to +60°C (+32°F to +140°F)
Working pressure	0 - 150 psi



BLOW GUN
WITH 100 MM TUBE

3760

PART NUMBER	THREAD	PRICE EACH	
		1 - 9	10 +
CDCB01-100F	1/4" BSP	£10.54	£9.43



BLOW GUN
WITH 100 MM TUBE

3760

PART NUMBER	THREAD	PRICE EACH	
		1 - 9	10 +
CDCB01-100G	1/4" BSP	£10.54	£9.43



TUBE CUTTER

3760

PART NUMBER	DESCRIPTION	PRICE EACH	
		1 - 9	10 +
CDETC20	Cuts up to 3/4" (20 mm) tubing	£22.04	£19.70

PRODUCT FEATURES

- Flexible coolant hose system
- Dimensionally stable through tight fitting components. Will not alter under pressure or machine vibrations
- Resistant to chemicals and solvents, non-conductive
- Compatible with competitive systems
- Coolant nozzles are ideally suited for positioning and distributing fluids and air
- Good tolerance to corrosion and chemicals
- Good anti-conductivity
- Variable flow direction
- Lightweight

APPLICATIONS

Cooling and cleaning in the following industries:

- Sawing
- Drilling
- Turning
- Milling
- Grinding

WORKING PRESSURE

Maximum flow rate: 16 l/min (to avoid hose jetting)
 Pressure rating: 2 – 3 bar (30 – 50 psi)
 Inside diameter: 1/4"

MATERIALS

Made from plastics to be semi permanent and lightweight

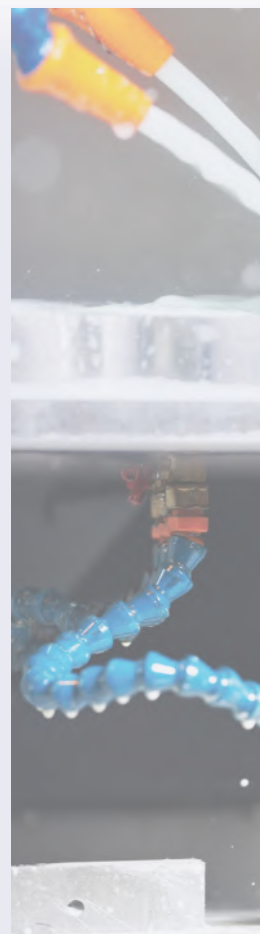

New



SINGLE KNUCKLE JOINT

3760

PART NUMBER	KNUCKLE JOINT	PRICE
CDOEL04-H04	1/4"	£1.10
CDOEL08-H08	1/2"	£1.60
CDOEL12-H12	3/4"	£2.62

New



BALL VALVE WITH KNUCKLE JOINT

3760

PART NUMBER	BALL VALVE	KNUCKLE JOINT	PRICE
CDOEL04-V04	1/4"	1/4"	£12.78
CDOEL08-V08	1/2"	1/2"	£17.77

New



BSPT MALE WITH KNUCKLE JOINT

3760

PART NUMBER	MALE THREAD	KNUCKLE JOINT	PRICE
CDOEL04-PT02	1/8" BSPT	1/4"	£0.95
CDOEL04-PT04	1/4" BSPT	1/4"	£1.14
CDOEL08-PT06	3/8" BSPT	1/2"	£1.32
CDOEL08-PT08	1/2" BSPT	1/2"	£1.80
CDOEL12-PT12	3/4" BSPT	3/4"	£5.23

New



Y JUNCTION WITH KNUCKLE JOINT

3760

PART NUMBER	Y JUNCTION	KNUCKLE JOINT	PRICE
CDOEL04-YF04	2 x	1/4"	£7.75
CDOEL08-YF08	2 x	1/2"	£8.96

New



ROUND NOZZLE WITH KNUCKLE JOINT

3760

PART NUMBER	NOZZLE	KNUCKLE JOINT	PRICE
CDOEL04-RN02	1/8"	1/4"	£1.01
CDOEL04-RN04	1/4"	1/4"	£1.24
CDOEL08-RN04	1/4"	1/2"	£1.24
CDOEL08-RN06	3/8"	1/2"	£2.65
CDOEL12-RN10	5/8"	3/4"	£5.23

New

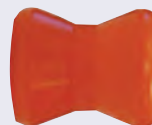

DOUBLE UNION WITH KNUCKLE JOINT

3760

PART NUMBER	KNUCKLE JOINT	PRICE
CDOEL04-DS04	1/4"	£4.19
CDOEL08-DS08	1/2"	£4.78

New



FAN NOZZLE WITH KNUCKLE JOINT

3760

PART NUMBER	NOZZLE	KNUCKLE JOINT	PRICE
CDOEL04-FN16	1"	1/4"	£1.64
CDOEL08-FN20	1/4"	1/2"	£6.54
CDOEL08-FN40	2"	1/2"	£8.01
CDOEL12-FN48	3"	3/4"	£14.37

New



REDUCING Y JUNCTION WITH KNUCKLE JOINT

3760

PART NUMBER	Y JUNCTION	KNUCKLE JOINT	PRICE
CDOEL08-YR0804	2 x 1/4"	1/2"	£8.96

New



16 HOLE FAN NOZZLE WITH KNUCKLE JOINT

3760

PART NUMBER	HOLE DIAMETER	KNUCKLE JOINT	PRICE
CDOEL04-16HN-1MM	1.0 mm	1/4"	£13.07
CDOEL04-16HN-1.5MM	1.5 mm	1/4"	£13.07

New

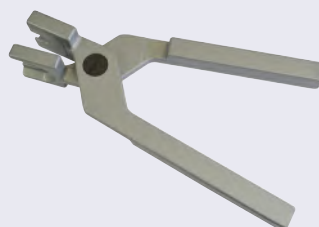

PLIERS

3760

PART NUMBER	DESCRIPTION	PRICE
CDOELP1418	1/4"	£157.88
CDOELP1238	1/2"	£157.88
CDOELP34	3/4"	£157.88

SUITABILITY	FEATURES / BENEFITS
<ul style="list-style-type: none"> Compressed air Vacuum Chemicals Oil 	<ul style="list-style-type: none"> Excellent flexibility at low pressure Lightweight with good tolerance to wear and chemicals Convenient for piping, as it has better flexibility than nylon tube
SPECIFICATIONS	
Temperature range	0°C to +60°C
Pressure rating	Vacuum 28" Hg Values given are based on the short term burst pressure of CDPU hose at 20°C using a 3:1 safety factor. NOTE: Any increase in temperature above 20°C will result in a decline in the working pressure values.
Construction	Colours – Polyester based PU Shore A 98 Clear – Polyester based PU Shore A 96 Ester based



Supplied on drums in full 100 m coils

CDPU – CLEAR 100 METRE COILS

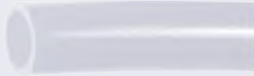

3755

PART NUMBER	Ø	Ø	Ø	PRICE per coil
CDPU0425CLR	4.0	2.5	10	£49.89
CDPU0640CLR	6.0	4.0	10	£75.37
CDPU0850CLR	8.0	5.0	10	£118.29
CDPU0855CLR	8.0	5.5	10	£109.20
CDPU1065CLR	10.0	6.5	10	£150.52
CDPU1280CLR	12.0	8.0	10	£201.16

CDPU – RED 100 METRE COILS



3755

PART NUMBER	Ø	Ø	Ø	PRICE per coil
CDPU0425RED	4.0	2.5	10	£49.89
CDPU0640RED	6.0	4.0	10	£75.37
CDPU0850RED	8.0	5.0	10	£118.29
CDPU0855RED	8.0	5.5	10	£109.20
CDPU1065RED	10.0	6.5	10	£150.52
CDPU1280RED	12.0	8.0	10	£201.16

CDPU – BLUE 50 METRE COILS



3755

PART NUMBER	Ø	Ø	Ø	PRICE per coil
CDPU1410BLU	14.0	10.0	10	£184.15
CDPU1611BLU	16.0	11.0	10	£208.33
CDPU1612BLU	16.0	12.0	10	£149.15

100 METRE COILS

CDPU0425BLU	4.0	2.5	10	£49.89
CDPU0640BLU	6.0	4.0	10	£75.37
CDPU0850BLU	8.0	5.0	10	£118.29
CDPU0855BLU	8.0	5.5	10	£109.20
CDPU1065BLU	10.0	6.5	10	£150.52
CDPU1280BLU	12.0	8.0	10	£201.16
CDPU1290BLU	12.0	9.0	10	£175.47

200 METRE COILS

CDPU0320BLU	3.0	2.0	10	£56.13
-------------	-----	-----	----	--------

CDPU – BLACK 100 METRE COILS



3755

PART NUMBER	Ø	Ø	Ø	PRICE per coil
CDPU0425BLK	4.0	2.5	10	£49.89
CDPU0640BLK	6.0	4.0	10	£75.37
CDPU0850BLK	8.0	5.0	10	£118.29
CDPU0855BLK	8.0	5.5	10	£109.20
CDPU1065BLK	10.0	6.5	10	£150.52
CDPU1280BLK	12.0	8.0	10	£201.16

CDPU – YELLOW 100 METRE COILS



3755

PART NUMBER	Ø	Ø	Ø	PRICE per coil
CDPU0425YEL	4.0	2.5	10	£49.89
CDPU0640YEL	6.0	4.0	10	£75.37
CDPU0850YEL	8.0	5.0	10	£118.29
CDPU0855YEL	8.0	5.5	10	£109.20
CDPU1065YEL	10.0	6.5	10	£150.52
CDPU1280YEL	12.0	8.0	10	£201.16

CDPU – GREEN 100 METRE COILS



3755

PART NUMBER	Ø	Ø	Ø	PRICE per coil
CDPU0425GRN	4.0	2.5	10	£49.89
CDPU0640GRN	6.0	4.0	10	£75.37
CDPU0850GRN	8.0	5.0	10	£118.29
CDPU0855GRN	8.0	5.5	10	£109.20
CDPU1065GRN	10.0	6.5	10	£150.52
CDPU1280GRN	12.0	8.0	10	£201.16

CDPU – TRANSPARENT BLUE 100 METRE COILS



3755

PART NUMBER	Ø	Ø	Ø	PRICE per coil
CDPU0425TB	4.0	2.5	10	£49.89
CDPU0640TB	6.0	4.0	10	£75.37
CDPU0855TB	8.0	5.5	10	£109.20
CDPU1065TB	10.0	6.5	10	£150.52
CDPU1280TB	12.0	8.0	10	£201.16

SUITABILITY	FEATURES / BENEFITS
<ul style="list-style-type: none"> Compressed air Vacuum Chemicals Oil 	<ul style="list-style-type: none"> Excellent flexibility at low pressure Lightweight with good tolerance to wear and chemicals Convenient for piping, as it has better flexibility than nylon tube
SPECIFICATIONS	
Temperature range	0°C to +60°C
Pressure rating	Vacuum 28" Hg Values given are based on the short term burst pressure of CDPU hose at 20°C using a 3:1 safety factor. NOTE: Any increase in temperature above 20°C will result in a decline in the working pressure values.
Construction	Colours – Polyester based PU Shore A 98 Clear – Polyester based PU Shore A 96 Ester based



Supplied boxed in full 25 m coils

CDPU – CLEAR 25 METRE COILS

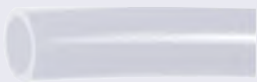

3755

PART NUMBER	Ø	W	Bar	PRICE per coil
CDPU0425CLR25	4.0	2.5	10	£14.46
CDPU0640CLR25	6.0	4.0	10	£21.66
CDPU0850CLR25	8.0	5.0	10	£33.31
CDPU0855CLR25	8.0	5.5	10	£31.68
CDPU1065CLR25	10.0	6.5	10	£47.03
CDPU1280CLR25	12.0	8.0	10	£62.46

CDPU – RED 25 METRE COILS



3755

PART NUMBER	Ø	W	Bar	PRICE per coil
CDPU0425RED25	4.0	2.5	10	£14.46
CDPU0640RED25	6.0	4.0	10	£21.66
CDPU0850RED25	8.0	5.0	10	£33.31
CDPU0855RED25	8.0	5.5	10	£31.68
CDPU1065RED25	10.0	6.5	10	£47.03
CDPU1280RED25	12.0	8.0	10	£62.46

CDPU – BLUE 25 METRE COILS



3755

PART NUMBER	Ø	W	Bar	PRICE per coil
CDPU0425BLU25	4.0	2.5	10	£14.46
CDPU0640BLU25	6.0	4.0	10	£21.66
CDPU0850BLU25	8.0	5.0	10	£33.31
CDPU0855BLU25	8.0	5.5	10	£31.68
CDPU1065BLU25	10.0	6.5	10	£47.03
CDPU1280BLU25	12.0	8.0	10	£62.46

CDPU – YELLOW 25 METRE COILS



3755

PART NUMBER	Ø	W	Bar	PRICE per coil
CDPU0425YEL25	4.0	2.5	10	£14.46
CDPU0640YEL25	6.0	4.0	10	£21.66
CDPU0850YEL25	8.0	5.0	10	£33.31
CDPU0855YEL25	8.0	5.5	10	£31.68
CDPU1065YEL25	10.0	6.5	10	£47.03
CDPU1280YEL25	12.0	8.0	10	£62.46

CDPU – BLACK 25 METRE COILS



3755

PART NUMBER	Ø	W	Bar	PRICE per coil
CDPU0425BLK25	4.0	2.5	10	£14.46
CDPU0640BLK25	6.0	4.0	10	£21.66
CDPU0850BLK25	8.0	5.0	10	£33.31
CDPU0855BLK25	8.0	5.5	10	£31.68
CDPU1065BLK25	10.0	6.5	10	£47.03
CDPU1280BLK25	12.0	8.0	10	£62.46

CDPU – GREEN 25 METRE COILS



3755

PART NUMBER	Ø	W	Bar	PRICE per coil
CDPU0425GRN25	4.0	2.5	10	£14.46
CDPU0640GRN25	6.0	4.0	10	£21.66
CDPU0850GRN25	8.0	5.0	10	£33.31
CDPU0855GRN25	8.0	5.5	10	£31.68
CDPU1065GRN25	10.0	6.5	10	£47.03
CDPU1280GRN25	12.0	8.0	10	£62.46

CDPU – TRANSPARENT BLUE 25 METRE COILS



3755

PART NUMBER	Ø	W	Bar	PRICE per coil
CDPU0425TB25	4.0	2.5	10	£14.46
CDPU0640TB25	6.0	4.0	10	£21.66
CDPU0855TB25	8.0	5.5	10	£31.68
CDPU1065TB25	10.0	6.5	10	£47.03
CDPU1280TB25	12.0	8.0	10	£62.46

SUITABILITY	FEATURES / BENEFITS
<ul style="list-style-type: none"> Compressed air Vacuum Chemicals Oil 	<ul style="list-style-type: none"> Excellent flexibility at low temperature Light weight with good tolerance to wear and chemicals Convenient for piping as it has better flexibility than nylon tube
SPECIFICATIONS	
Temperature range	0°C to +60°C
Pressure rating	Vacuum 28" Hg. Values given are based on the short term burst pressure of CDUC hose at 20°C using a 3:1 safety factor. NOTE: Any increase in temperature above 20°C will result in a decline in the working pressure values
Construction	Polyester based PU Shore A 98



RECOIL WITH FIXED NIPPLE AND SPRING

RECOIL WITHOUT NIPPLE AND SPRING

CDUC WITH BSPT FIXED NIPPLE – YELLOW

43 MM MANDREL SIZE



3757

PART NUMBER					PRICE per recoil
CDUC0805Y-5	8.0	5.0	5.0	1/4	£18.35
CDUC0805Y75	8.0	5.0	7.5	1/4	£20.54
CDUC0805Y10	8.0	5.0	10.0	1/4	£24.29
CDUC1065Y-5	10.0	6.5	5.0	1/4	£20.52
CDUC1065Y75	10.0	6.5	7.5	1/4	£24.56
CDUC1065Y10	10.0	6.5	10.0	1/4	£27.80

CDUC – YELLOW

43 MM MANDREL SIZE



3757

PART NUMBER				PRICE per recoil
CDUCB0604Y-3	6.0	4.0	3.0	£13.48
CDUCB0604Y-5	6.0	4.0	5.0	£14.99

60 MM MANDREL SIZE

CDUC1208Y-5	12.0	8.0	5.0	3/8	£24.28
CDUC1208Y75	12.0	8.0	7.5	3/8	£28.83
CDUC1208Y10	12.0	8.0	10.0	3/8	£33.98

CDUC WITH BSPT FIXED NIPPLE – RED

43 MM MANDREL SIZE



3757

PART NUMBER					PRICE per recoil
CDUC0805R-5	8.0	5.0	5.0	1/4	£18.35
CDUC0805R75	8.0	5.0	7.5	1/4	£20.54
CDUC0805R10	8.0	5.0	10.0	1/4	£24.29
CDUC1065R-5	10.0	6.5	5.0	1/4	£20.52
CDUC1065R75	10.0	6.5	7.5	1/4	£24.56
CDUC1065R10	10.0	6.5	10.0	1/4	£27.80

CDUC – RED

43 MM MANDREL SIZE



3757

PART NUMBER				PRICE per recoil
CDUCB0604R-3	6.0	4.0	3.0	£13.48
CDUCB0604R-5	6.0	4.0	5.0	£14.99

60 MM MANDREL SIZE

CDUC1208R-5	12.0	8.0	5.0	3/8	£24.28
CDUC1208R75	12.0	8.0	7.5	3/8	£28.83
CDUC1208R10	12.0	8.0	10.0	3/8	£33.98

CDUC WITH BSPT FIXED NIPPLE – BLUE

43 MM MANDREL SIZE



3757

PART NUMBER					PRICE per recoil
CDUC0805B-5	8.0	5.0	5.0	1/4	£18.35
CDUC0805B75	8.0	5.0	7.5	1/4	£20.54
CDUC0805B10	8.0	5.0	10.0	1/4	£24.29
CDUC1065B-5	10.0	6.5	5.0	1/4	£20.52
CDUC1065B75	10.0	6.5	7.5	1/4	£24.56
CDUC1065B10	10.0	6.5	10.0	1/4	£27.80

CDUC – BLUE

43 MM MANDREL SIZE



3757

PART NUMBER				PRICE per recoil
CDUCB0604B-3	6.0	4.0	3.0	£13.48
CDUCB0604B-5	6.0	4.0	5.0	£14.99

60 MM MANDREL SIZE

CDUC1208B-5	12.0	8.0	5.0	3/8	£24.28
CDUC1208B75	12.0	8.0	7.5	3/8	£28.83
CDUC1208B10	12.0	8.0	10.0	3/8	£33.98

SPECIFICATIONS	
Temperature range	-2°C to +66°C
Maximum pressure	4 mm, 5 mm, 6 mm = 230 psi 8 mm, 10 mm, 12 mm = 170 psi NOTE: Any increase in temperature above 20°C will result in a decline in the working pressure values
Tube tolerance	+0.1 mm/-0.1 mm

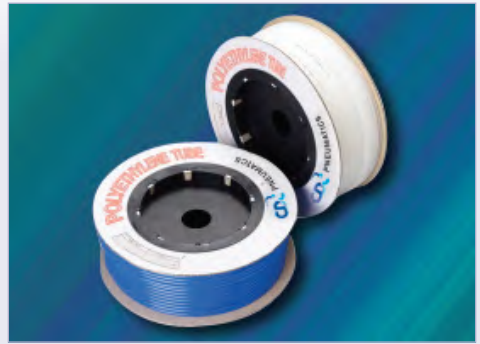

Supplied on drums in full coils only

PE – BLUE 100 METRES



3770

PART NUMBER				PRICE per coil
CDPE0640BLU	6 mm	4.0 mm	15 bar	£32.69
CDPE0860BLU	8 mm	6.0 mm	11 bar	£46.27
CDPE1070BLU	10 mm	7.0 mm	11 bar	£69.15
CDPE1290BLU	12 mm	9.0 mm	11 bar	£87.50

200 METRES

CDPE0425BLU	4 mm	2.5 mm	15 bar	£37.72
-------------	------	--------	--------	--------

PE – BLACK 100 METRES



3770

PART NUMBER				PRICE per coil
CDPE0640BLK	6 mm	4.0 mm	15 bar	£32.69
CDPE0860BLK	8 mm	6.0 mm	11 bar	£46.27
CDPE1070BLK	10 mm	7.0 mm	11 bar	£69.15
CDPE1290BLK	12 mm	9.0 mm	11 bar	£87.50

200 METRES

CDPE0425BLK	4 mm	2.5 mm	15 bar	£37.72
-------------	------	--------	--------	--------

PE – CLEAR 100 METRES



3770

PART NUMBER				PRICE per coil
CDPE0640CLR	6 mm	4.0 mm	15 bar	£32.69
CDPE0860CLR	8 mm	6.0 mm	11 bar	£46.27
CDPE1070CLR	10 mm	7.0 mm	11 bar	£69.15
CDPE1290CLR	12 mm	9.0 mm	11 bar	£87.50

200 METRES

CDPE0425CLR	4 mm	2.5 mm	15 bar	£37.72
-------------	------	--------	--------	--------

PE – RED 100 METRES



3770

PART NUMBER				PRICE per coil
CDPE0640RED	6 mm	4.0 mm	15 bar	£32.69
CDPE0860RED	8 mm	6.0 mm	11 bar	£46.27
CDPE1070RED	10 mm	7.0 mm	11 bar	£69.15
CDPE1290RED	12 mm	9.0 mm	11 bar	£87.50

200 METRES

CDPE0425RED	4 mm	2.5 mm	15 bar	£37.72
-------------	------	--------	--------	--------

PE – WHITE 100 METRES



3770

PART NUMBER				PRICE per coil
CDPE0640WHT	6 mm	4.0 mm	15 bar	£32.69
CDPE0860WHT	8 mm	6.0 mm	11 bar	£46.27
CDPE1070WHT	10 mm	7.0 mm	11 bar	£69.15
CDPE1290WHT	12 mm	9.0 mm	11 bar	£87.50

200 METRES

CDPE0425WHT	4 mm	2.5 mm	15 bar	£37.72
-------------	------	--------	--------	--------

