

# SRM-500T

## VACUUM TUBE OUTPUT DRIVER UNIT FOR EARSPEAKERS

(Amplifier for STAX Headphones)

### User's Manual

Thank you for purchasing STAX Driver Unit for Earspeakers SRM-500T.

Please read this instruction manual carefully to enjoy sound, performance and functions of SRM-500T for a long time.

After reading this manual, be sure to keep it with the warranty.

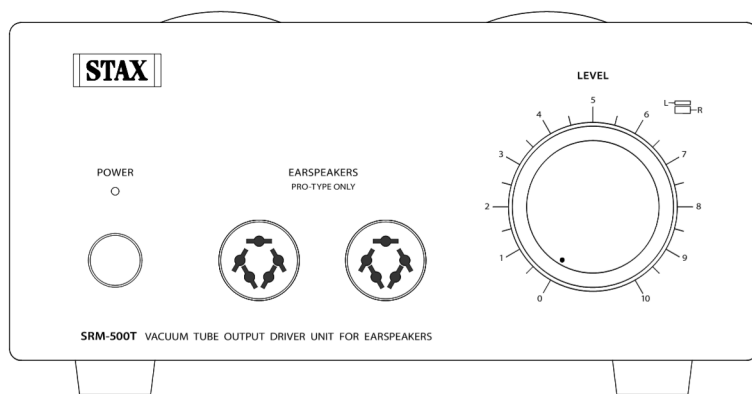

This unit contains a high voltage circuitry. Never disassemble or modify the unit.

**RISK OF ELECTRIC SHOCK DO NOT OPEN!**

The SRM-500T contains high voltage circuitry.



It is dangerous to disassemble or to remodel it. Please observe Don'ts.

**STAX®**

# 1. To Ensure Safe Use (Please read first)

## ● Before using: about warning symbols

This manual uses various warning symbols for safety use. The symbols are classified as below. Please read the symbol description first.

 <b>Warning</b>	This symbol indicates a hazard that could cause death or serious injury if the warning is ignored and the unit is misused.
 <b>Caution</b>	This symbol indicates a hazard that could cause injury or product damage if the caution is ignored and the unit is misused.



Triangle symbols indicate cautions (including warnings).  
This example on the left indicates “Risk of electric shock”.





Circle with a slash symbols indicate prohibited actions.  
This example on the left indicates “Do not disassemble”.





Black circle symbols indicate mandatory actions.  
This example on the left indicates “Unplug the unit”.

## Warning

	<ul style="list-style-type: none"> <li>● Do not handle the power plug and the earspeaker plug with wet hands. It may cause electric shocks.</li> <li>● Use the unit only on the specified power supply.</li> <li>● Do not modify, forcibly bend, twist or pull the power cable.</li> <li>● Do not block the ventilation holes on the top cover for heat dissipation.</li> <li>● Do not insert metal, liquid or objects inside of the unit.</li> <li>● Do not touch the earspeaker output terminal.</li> </ul>
	<ul style="list-style-type: none"> <li>● If the unit emits unusual smells or smoke, stop using immediately and turn off the power. This may cause fires and electric shocks. Do not attempt to repair the unit by yourself. For repairs, consult the dealer from which you purchased or a nearest distributor.</li> </ul>
	<ul style="list-style-type: none"> <li>● Do not remove the bottom cover and the top cover.</li> <li>● Do not disassemble or modify the unit.</li> </ul>

## Caution

	<p>Do not place the unit in the places as below. It may cause injury or breakdowns.</p> <ul style="list-style-type: none"> <li>● Tilted places or places exposed to vibration, shocks or direct sunlight</li> <li>● Wet, humid or dusty places.</li> <li>● Places with large temperature difference or places near heat emitting devices (heaters, stoves etc.)</li> <li>● Do not put earspeakers or objects on the unit. Blocking ventilation holes causes heat and breakdowns of the unit.</li> </ul>
	<ul style="list-style-type: none"> <li>● Do not drop or expose the unit to shock.</li> <li>● Do not turn up the volume too high. It may damage your ears and the unit.</li> </ul>

## 2. Instruction for use

---

- Before connecting, make sure that the power switch is set to OFF. (Refer to page 4)
- Connect to the output terminal (RCA pin jack or XLR connector) of the audio player device.  
For RCA connection, use the attached cable.  
For XLA connection, use your cable.  
Both XLR input and RCA input are connectable, but input signals cannot be switched.  
Be sure to disconnect the unused cable.
- XLR connector pinout drawing indicates that No.2 is HOT.  
To use Pin-3 HOT audio player device, use your conversion adaptor or cable.
- Plug the attached power cable into AC inlet on the rear panel and insert the plug into the outlet on the wall.
- Plug the earspeakers to the earspeaker sockets on the front panel.
- Push the power button. The orange LED ① flashes. Wait for about 30 seconds until the vacuum tube heater is enough heated. When the unit is ready to be used, the LED is changed to the steady light.
- Turn the volume knob slowly to the right to adjust to the best volume.  
Turn the front section of the concentric dual knob to adjust the left channel.  
Turn the back section of the knob to adjust the right channel.  
Adjust the left/right volume balance with this knob.
- If the volume is not enough using a “REC OUT” terminal of a pre-amplifier or integrated amplifier, connect to a PRE OUT terminal.
- Another way to connect: To connect to a audio player device with a mini stereo jack.  
Your stereo mini plug to RCA plug conversion cable or conversion plug can be connected to the unit.  
Set the volume of your audio player device to the normal position. And adjust the volume of SRM-500T.

## 3. Precautions for use

---



- The unit contains a high voltage circuitry. It is dangerous. Do not remove the top cover and the bottom cover. Do not use the unit in wet, dusty, high temperature humid places.
- The unit emits heat. Do not block the ventilation holes on the top and bottom of the unit. Install the unit in a well ventilated place.
- To install on shelves, make sure that there is at least 5cm space between the unit and a shelf board.
- Do not install the unit vertically.
- Because of low distortion, the volume of the earspeakers is likely to be too high.  
Listening sound at high volume for a long time is not good for your health.
- If the unit is installed near a main amplifier, hum noises may be emitted.
- The power cable is exclusive for SRM-500T. Use only the attached power cable.
- Unplug the power cable from an outlet when not in use for a long time.

# 4. Part Names and Functions

## [Front Panel]

The top cover has ventilation holes.  
Do not put objects on the top cover.

### ① Power display LED :

The LED flashes when power is on.  
The LED flashes for about 30 seconds after power is on. When the heater is enough heated, the LED is changed to the steady light.

### ② Power switch:



Push the button to turn on. Push the button once again to turn off.  
If power is turned off and immediately turned on after the heater is heated, LED flashes.

### ③ Sockets for PRO type earspeaker:

Plug a 5-pin type earspeaker.

### ④ Volume knob:

The concentric dual knob can be turned simultaneously.  
To adjust left and right audio balance, turn one section of the knob independently.  
The front section is for L-CH and the back section is for R-CH.

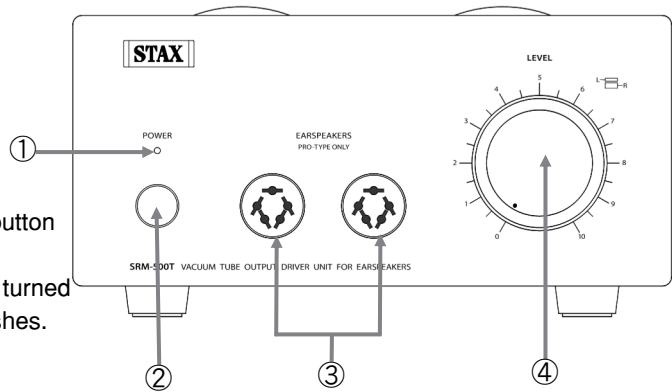

## [Rear Panel]

### ⑤ XLR input terminals:

Connect your audio device with XLR output terminals.

### ⑥ XLR connector pinout drawing:

- 1: SHIELD
- 2: HOT
- 3: COLD

To use Pin-3 HOT audio player device, use your conversion adaptor or cable.

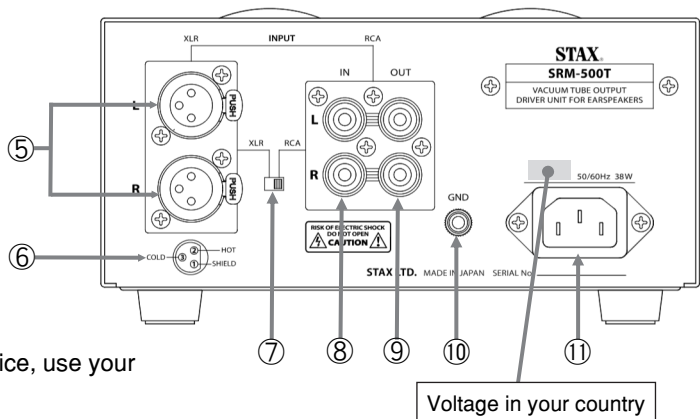

### ⑦ SOURCE selector switch: Select XLR or RCA input. For the factory default, the unit is set to "RCA".

**Caution!** This unit cannot switch input signals. Unplug an unused cable.

### ⑧ RCA input terminals: Connect an audio player device with RCA output terminal.

### ⑨ PARALLEL OUT terminals (Throughout terminals):

Using PARALLEL OUT terminals, signals from an audio player device are directly outputted.

Use PARALLEL OUT terminals to connect other amplifier or driver unit.

Unplug the cable when a device connected to PARALLEL OUT terminals is not used.

※ In rare cases, when a device connected to PARALLEL OUT terminals is not operating, playback signals may be distorted. In this case, turn on or unplug a device connected to PARALLEL OUT terminals.

### ⑩ GND: Ground terminal:

In case that hum noises are emitted, be sure to make the ground connection.

Connect a grounding wire to a ground terminal or metal parts (bolts etc.) of other devices, or an outlet grounding terminal. Types, materials, thickness and colors of grounding wires do not matter.

### ⑪ AC inlet: Plug the attached power cable.

# 5. Connecting samples (On rear panel)



RCA/XLR input terminals cannot be simultaneously connected.  
Be sure to unplug an unused cable.

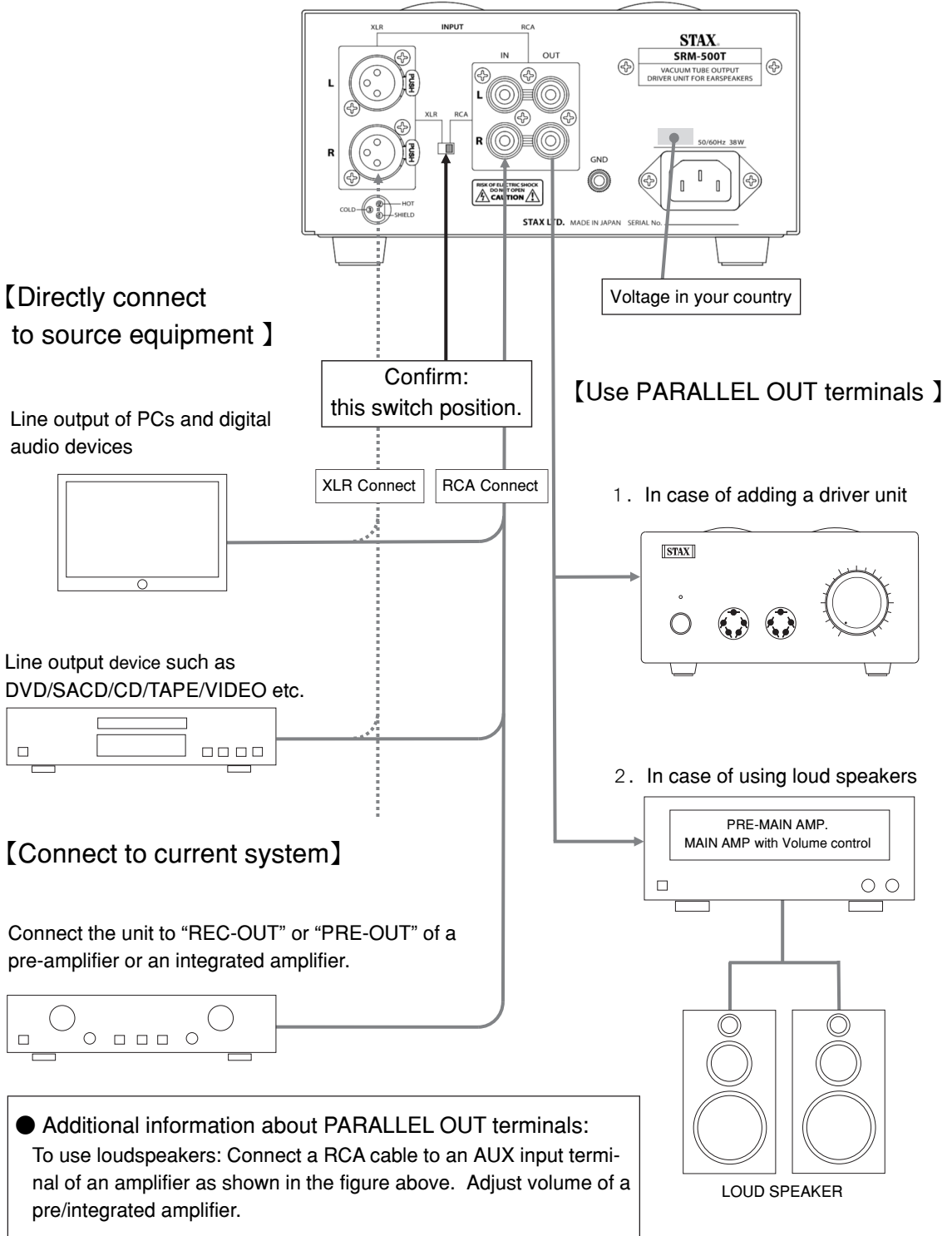

# 6. Troubleshooting

---

## No sound

- Is the power cable plugged into a socket?
- Is the power switch set to "ON"?
- Does LED on the front panel light up ?
- Is there anything wrong with the connecting cable?
- If the unit is connected to a pre-amplifier or integrated amplifier, is the SOURCE selector switch set to the correct position?  
Refer to the instruction manual of your amplifier.

## Sound is Distorted:

- Is the power voltage normal?
- Too high volume level may cause distortion.  
Too high volume is bad for your devices and health.
- In rare cases, when a device connected to a terminals (amplifier etc.) is not operating, input impedance extremely goes down and signals from an audio player device may be distorted.  
In this case, unplug a device connected to PARALLEL OUT terminals.  
The distortion does not occur if the volume of SRM-500T (or other STAX SRM series) is turned to zero.

## Unbalanced sound between right and left channel:

- Is the input signal normal?
- Are there any contact failures of a cable?
- When raising volume slowly from zero, sound may not start at the same time from left and right channels. This is normal and not a failure.
- Correct this unbalance by adjusting each section of the volume knob.

## Hum noise is heard

- Is a input terminal properly connected?  
Hum noises may occur when a grounding wire comes off.
- In case that "boon" hum noises are emitted, connect a grounding wire to a ground terminal or metal parts of other devices.  
Also you can connect a grounding wire to metal parts of aluminum sash windows.
- Are there any contact failures?
- Because the main material of the chassis is nonmagnetic aluminum alloy, multiple devices may induce hum noises.  
Are devices containing large transformers or microwaves near the unit?  
Keep distance between the devices.
- Hum noises may be emitted for instance just after the power is turned off.  
This is not a breakdown.

If there are any troubles and breakdowns, please contact the dealer from which it was purchased or a nearest distributor.

# 7. Specifications

---

- Frequency response : DC ~ 90kHz / +0, -3dB (SR-L500 1pc use)
- Rated input level : 100mV / 100V output
- Maximum input level : 30Vr.m.s. (at minimum volume)
- Gain : 60dB
- Harmonic distortion : 0.01% or less (1kHz/100Vr.m.s. output)
- Input terminal : RCA or XLR (Exclusive use)
- Input impedance : 50K $\Omega$  (RCA) / 50K $\Omega$  × 2 (XLR)
- Maximum output voltage : 300V r.m.s. / 1kHz
- Standard bias voltage : DC 580V
- Mains voltage : AC120V/AC220V/AC230V/AC240V, 50/60Hz  
(depending on your country's voltage)
- Power consumption : 38W
- Operating temperature : 0 to 35 degrees (non condensing)
- Dimension : 195 (W) × 102 (H) × 346 (D) mm Main body  
Include VR Knob (19) , GND terminal (11) : 376 (D) mm
- Weight : 3.4Kg
- Others : equipped with through output (RCA)
- Vacuum tube : 6CG7(6FQ7) x 2

\* Specifications and appearance are subject to change without notice for improvement.

\* This product is adjusted to mains voltage depending on each country.

## Accessories

---

- Power cable ..... 1
- RCA cable ..... 1
- Warranty card ..... 1
- User's manual ..... 1

### About exchange of vacuum tube:

Please make inquiries about vacuum tube replacement at your dealer.  
Inadequate tube may lead to failure of the unit.

## Care and cleaning

---

- Pull out power cable from wall socket and wipe it with dry soft cloth. When very dirty, wipe off dirt with wet cloth and then again with dry cloth.
- Do not use benzine, thinner or alcohol since paint, printing, etc. may come off. Before using chemical dust cloth, check its attached explanation to see it is usable for audio equipment.

**STAX**®

**STAX LIMITED**

3798-1 Shimonanbata, Fujimi-shi, Saitama-ken, Japan 〒354-0004

Tel: +81-49-293-1891 Fax: +81-49-293-1892 URL: <https://stax-international.com/>

Printed in Japan 21-02-1K MP © STAX LTD  
P/No. 80466-10111