

S.M.S.L

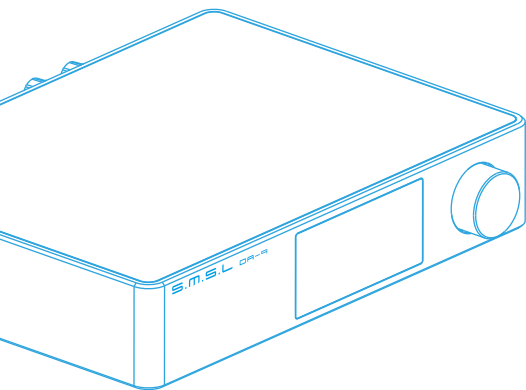

DA-9

使用说明书



安全注意事项

- 请将本音响系统安装在通风良好、阴凉、干燥、干净的位置，远离直射阳光热源、振动、灰尘、潮湿或寒冷。
- 只能使用本机指定的电压。使用高于指定数值的电压很危险，而且可能导致火灾，损坏本机或造成人身伤害。对于使用高于指定电压造成的任何损害，我司将不负任何责任。
- 不要试图自行改造或修理本机。如果需要任何服务，请与销售或者我司客服人员联系。不管有任何理由，都没有打开机壳的必要。
- 如果打算长时间不使用本机（比如度假时），请从墙壁交流电源插座上断开电源线的连接。

重要提示：

本说明书所提到的产品规格和资讯仅供参考。如有内容更新，恕不另行通知。

保修条款

一、服务期限

佛山双木三林科技有限公司承诺产品的良好品质，产品自售出之后7天内正常使用情况下出现故障，客户可以选择退货或者保修（不影响二次销售才可退货）。正常使用一年内出现故障可以免费保修。

二、购买日期以销售商开出的购机发票或收据日期为准，网购可以交易截图为准。

三、有以下情况都不能享受“三包”服务

1. 一切人为因素损坏，包括非正常工作环境下使用或不按照说明书使用。
2. 用户私自拆机、改装、维修。
3. 使用非指定或许可的配件造成损坏的。
4. 机身的QC或保修贴损毁。
5. 不能出示有效购机凭证。
6. 不属于本公司产品。

四、保修方式为送修

此条款只适于中国大陆，其它地区请参考当地销售代理商的规定和国家法规。

产品特点

- 内置2片德国英飞凌新型碳化硅数字功率放大器芯片, 更高音质的同时, 效率高达92%, 进一步降低能耗;
- 使用了日本NJRC公司电子音量控制芯片NJW1194, 精准的音量控制和超低的失真度;
- 真正全平衡设计, 从平衡输入到喇叭输出均为平衡, 大大降低信号传输时造成的失真;
- 内置SMSL SDB专利音效和高/低音调节功能, 轻松匹配各种喇叭和音乐;
- 具备超低音信号前级输出, 方便连接有源低音炮组成2.1系统.
- 美国高通蓝牙5.0接收, 更远的传输距离, 并且支持APT-X, 音质更好!
- 全铝合金CNC加工工艺, 采用阳极氧化技术, 做工精细, 触感一流;
- 彩色液晶显示屏和人性化操作系统简单易懂, 配备全功能遥控功能;
- 具备满足欧盟最新ErP2标准的低功耗待机功能;
- 大量采用发烧级音频元件以提升主观听感;
- 高品质镀金输入、输出端子;
- 完善的过热, 过流等保护电路;
- 内置高品质大功率音频专用开关电源。

技术参数

输入接口	XLR , RCA , BT
THD+N	0.003%
信噪比	111dB
通道分离度	96dB
输入灵敏度/输入阻抗.....	250mV/47k Ω
输出功率	150Wx2(2 Ω) / 90Wx2(4 Ω) / 50Wx2(8 Ω)
消耗功率	40W(正常音量)
待机功率	0.6W
体积.....	187.5X154X40mm(WxHxD)
重量.....	0.96kg
重量(带包装).....	1.46kg

关于遥控器

- 如果遥控器距离本机很近时操作仍无效，请用新电池更换。
- 如果要长时间不使用遥控器，请取出遥控器的电池。
- 按照电池处置的地方性法规处置废旧电池。

遥控器的使用

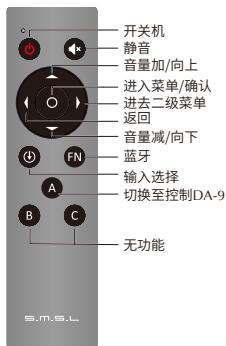

注意

1. 遥控器请使用2节7号(AAA)电池
2. 第一次操作DA-9时,先按A键

部件介绍



- | | | |
|----------------|----------------|--------------------|
| 1 功能旋钮 | 2 显示屏 | 3 红外接收窗 |
| 4 蓝牙天线 | 5 非平衡输入 | 6 平衡输入(XLR) |
| 7 超低音输出 | 8 左声道输出 | 9 右声道输出 |
| 10 电源输入 | | |

注:

连接喇叭时请注意极性, 必须按产品标注的极性, 以免影响音质。

操作说明

1. 主界面

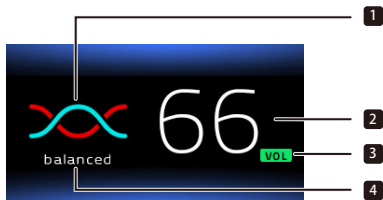

- 1、输入源图标
- 2、音量显示
- 3、静音时为红色
- 4、输入源名字

功能介绍

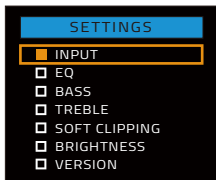

有6页的设置, 屏幕如下图所示

1. INPUT (输入选择)
2. EQ (音效模式)
3. BASS (低音调整)
4. TREBLE (高音调整)
5. SOFT CLIPPING(软限幅)
6. BRIGHTNESS (亮度)
7. VERSION (版本号)

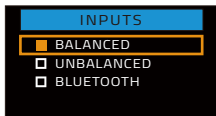

输入菜单

1. BALANCED (平衡输入)
2. UNBALANCED (非平衡输入)
3. BLUETOOTH (蓝牙输入)

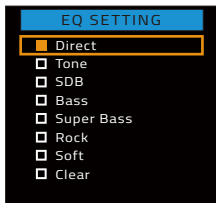

EQ菜单

1. Direct (直通)
2. Tone (自定义)
3. SDB (SMSL专利音效)
4. Bass (低音加强音效)
5. Super Bass (低音超强音效)
6. Rock (摇滚乐音效)
7. Soft (柔和音效)
8. Clear (清晰音效)

功能介绍

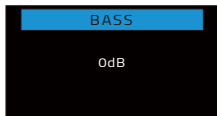

低音调节范围:-10dB ~ +10dB

当EQ处于直通或其他EQ模式时, 调节低音, EQ模式会自动切换到Tone的状态



高音调节范围:-10dB ~ +10dB

当EQ处于直通或其他EQ模式时, 调节高音, EQ模式会自动切换到Tone的状态



软限幅

1. ON
2. OFF



亮度调节范围:LEVEL 1~6

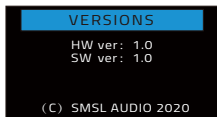

版本号

功能介绍

■ 蓝牙操作说明

本产品配备了**蓝牙按键**,就是遥控器上的**FN按键**,
这个按键的功能包括:

短按: 直接切换到蓝牙输入,如果蓝牙失去连接,则为重新连接;

长按: 断开当前设备,允许配对其它设备

- **连接:** 将输入源切换至蓝牙,打开手机蓝牙功能,搜索“**SMSL BT5.0A**”,搜索到后点击配对连接,当手机显示“已连接”则已连接成功。
- **重连:** 在使用蓝牙过程中,如果失去连接,例如:外出,然后回来,有些手机不会自动重新连接,在这个时候,**短按遥控器的蓝牙按键(FN)**就可以重新连接。
- **连接新设备: 长按遥控器的蓝牙按键(FN)**。在清除配对后,部分手机可能会出现无法再搜索到“SMSL BT5.0A”,此时需要将手机保存的蓝牙设备“SMSL BT5.0A”删除掉,然后再搜索配对。

■ 恢复出厂设置

- 机器在未通电状态下,按住开机键再通电,直到显示屏显示文字之后,松开按键。

S.M.S.L



DA-9

USER MANUAL

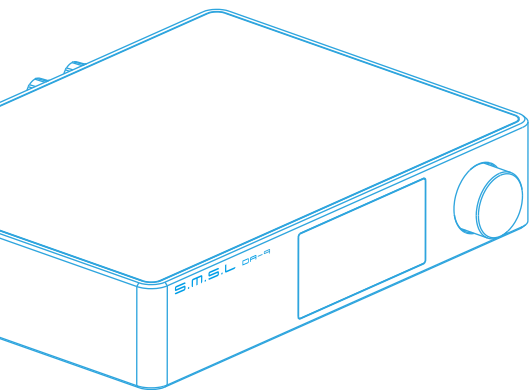

Safety Notes

- Install this unit in a well ventilated, cool, dry, clean place-away from direct sunlight, heat sources, vibration, dust, moisture, or cold..
- Use the voltage specified on this unit Only. Using this unit with a higher voltage than specified is dangerous and may cause fire , damage to this unit, or personal injury. Our company will not be held responsible for any damage resulting from the use of this unit with a voltage other than that specified.
- Do not attempt to modify or fix this unit by yourself. Contact alesperson or customer service when any service is needed. The cabinet should never be opened for any reason.
- When not planning to use this unit for long periods of time (i.e. when going on vacation), disconnect the power cable from the AC wall outlet.

Important note:

The product specifications and information mentioned in this manual are for reference only. The content of this manual is subject to change without notice.

Warranty Terms

1.The Term of Service

Foshan Shuangmusanlin Technology Co., Ltd promises to offer good-quality products. If the product is broken in 7 days after purchasing when you use it normally, you can choose to send it back for return, replacement or repairing (only the product does not affect the second sales can be returned). Repairing for free in one year if you use it normally.

2.Date of purchase is in accordance with the date on invoice or receipt used by seller, and if you buy it on line, you can show the screenshot of trade.

3.If an inappropriate usage causes the unit damaged, the warranty will be void. As below.

- All damages by inappropriate use, including using it under non-normal working environment or without following the instructions.
- Dismantling, refitting, repairing by user in private.
- Causing damage by using some fittings instead of the designative or accredited ones.
- Cannot provide credible proof of purchase.

4.Sending it back to our company for repairing.

5.Contact your S.M.S.L Audio reseller for a return or replacement.

Features

- 2xGerman Infineon's new technology class D power amplifier chip, higher quality, efficiency up to 92%, further reducing power consumption;
- Using NJRC's electronic volume control chip NJW1194 from Japan, precise volume control and low distortion;
- The true fully balanced design, from input to speaker output, greatly reducing distortion caused by signal transmission;
- Built-in SMSL SDB patented sound and treble/bass adjustment for easy matching of a variety of speakers and music;
- Subwoofer pre out for 2.1 system application.
- New Bluetooth 5.0 reception, better sound quality, longer transmission distance, support APT-X!
- All aluminum alloy CNC precision processing shell, anodizing technology and chamfering process, exquisite workmanship and delicate touch;
- Color LCD display and user-friendly operating system are simple and easy to understand, equipped with full-featured remote control function;
- Low power standby function to meet the latest European ErP2 standard;
- A large number of professional Hi-Fi audio components are used to enhance the sound experience;
- High quality gold-plated input and output terminals;
- Perfect protection circuit for overheating, overcurrent, etc.
- Built-in high quality power supply, specially designed for audio!

Specifications

Inputs	XLR , RCA , BT
THD+N	0.003%
SNR	111dB
Channel separation	96dB
Input Sensitivity / Input Impedance.....	250mV/47k Ω
Output Power	150Wx2(2 Ω) / 90Wx2(4 Ω) / 50Wx2(8 Ω)
Power Consumption	40W(Normal Volume)
Standby power	0.6W
Size	187.5X154X40mm(WxHxD)
Weight	0.96kg
Weight (In shipping carton).....	1.46kg

Remote control

- Install 2 x AAA batteries as instructions.
- When using the remote control, point it toward the remote control signal receiver on the main unit from a distance of 5 m (16 ft) or less. Do not place obstructions between the main unit and the remote control.
- The remote control might not work if the remote control signal receiver on the unit is exposed to direct sunlight or bright light. If this occurs, try moving the unit. Beware that use of this remote control could cause the unintentional operation of other devices that can be controlled by infra.

Operating the remote control

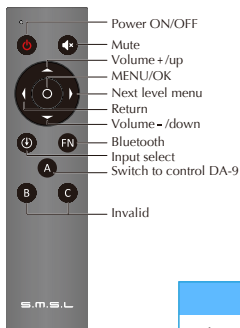

Note

1. This remote controller use 2 x R03/AAA batteries.
2. When you first operate DA-9, press the A key first.

Display Interface and Instructions

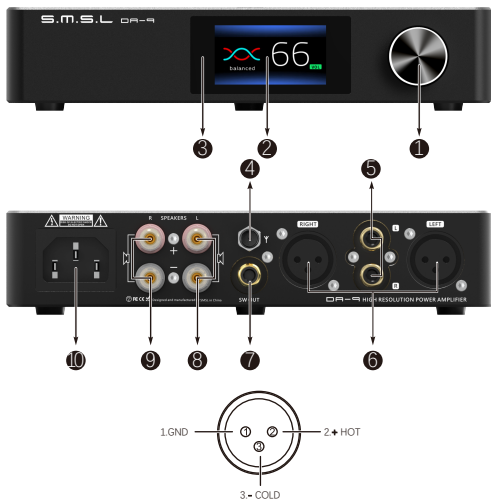

- | | | |
|-----------------------|------------------------------|-------------------------------|
| 1 Knob | 2 Display | 3 Remote window |
| 4 Antenna | 5 RCA | 6 XLR |
| 7 SW out | 8 Left channel output | 9 Right channel output |
| 10 Power input | | |

Note:

Please pay attention to the polarity when connecting the speakers, it must follow the mark on the unit, to avoid any effect to the sound quality.

User interface

1. Main

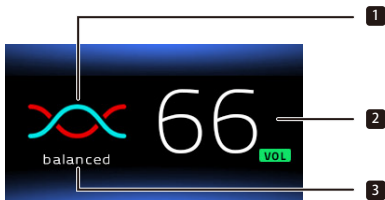

- 1、 Input source icon
- 2、 Volume Level
- 3、 Red when muted
4. Input source name

Display Interface and Instructions



There are 6 pages of settings in this menu.

1. INPUT
2. EQ
3. BASS
4. TREBLE
5. SOFT CLIPPING
6. BRIGHTNESS
7. VERSION

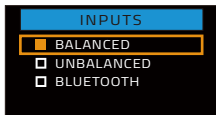

INPUTS

1. BALANCED
2. UNBALANCED
3. BLUETOOTH

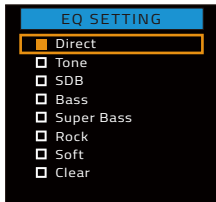

EQ Setting

1. Direct
2. Tone
3. SDB
4. Bass
5. Super Bass
6. Rock
7. Soft
8. Clear

Display Interface and Instructions

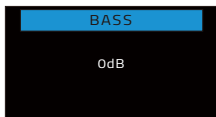

Bass adjustment range: -10dB ~ +10dB

When the EQ mode is Direct or other EQ mode, changing the Bass will change the EQ to Tone mode.



Treble adjustment range: -10dB ~ +10dB

When the EQ mode is Direct or other EQ mode, changing the Treble will change the EQ to Tone mode.

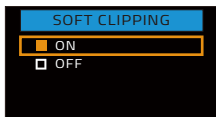

SOFT CLIPPING

1. ON
2. OFF



Brightness Level: 1 ~ 6

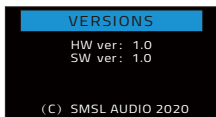

VERSIONS

(C) SMSL AUDIO 2020

Display Interface and Instructions

Bluetooth operating instructions

This product is equipped with a **Bluetooth button**, which is the **FN button** on the remote control. The functions of this button include:

- **Short press:** Switch directly to Bluetooth input, if Bluetooth loses connection, it is a reconnect;
- **Long press:** Disconnect the current device and allow pairing with other devices.

Connection:

- Step 1: Switch the input source in the SETTING MENU or press the Bluetooth button of the remote;
- Step 2: Turn on the Bluetooth function of the mobile phone, search for "**SMSL BT5.0A**", and tap to pairing. When the mobile phone displays "connected", it has been successfully connected.

Re-connection:

When you had lost the connection with the DA-9, for example, going out, and back home, some phones will not re-connect the DA-9 if the DA-9 has not been re-boot, so you can **press the Bluetooth button (FN)** on the remote to Re-connect.

Clear pairing: Long press the "**Bluetooth**" button(FN) on the remote control. After clearing the pairing, some phones may no longer be able to search for "SMSL BT5.0A". In this case, you need to delete the Bluetooth device "SMSL BT5.0A" which saved in the phone, and then search and pairing again.

Factory Reset

- Connect the power cord when pressing the power button, until the screen shows the logo. Then stop pressing and restart the unit.