

Cayin

HA-2A真空管耳机功率放大器

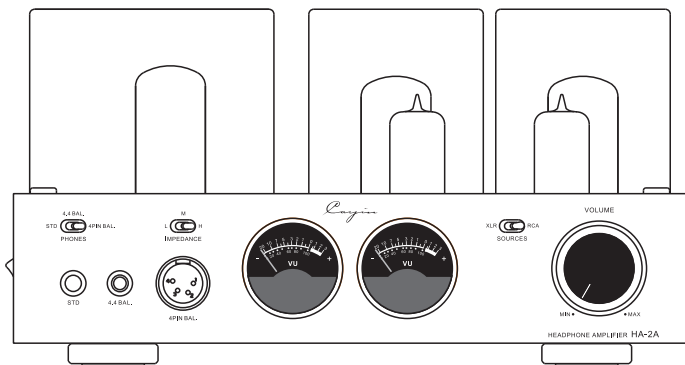

使用说明书

感谢您购买Cayin HA-2A 真空管耳机功率放大器。

在使用前请仔细阅读此使用手册。

本产品在真空管罩内加装了珍珠棉，防止在运输过程中损坏真空管。在使用本产品前，请将真空管罩内的珍珠棉取出，否则会导致机器损坏或发生火灾。

目 录

目录.....	1
开箱.....	2
安全注意事项.....	2
本机特点.....	3
技术参数.....	3
前面板功能说明.....	4
顶面板功能说明.....	5
常用真空管代换表.....	5
后面板功能说明.....	6
安装.....	6
设备连接.....	7
耳机连接.....	8
开机.....	9
机器保养.....	9
保修.....	9
一般故障处理.....	10
真空管安装示意图.....	11

● 開箱 -----

開箱前請仔細檢查包裝箱有無摔傷、破損或濕迹，並將包裝箱置於箭頭向上狀態。打開包裝箱，裝箱清單如下：

1. HA-2A真空管耳機功率放大器一台。
2. 產品使用說明書一本。
3. 產品保修卡一份。
4. 電源線一根。
5. 備用保險管：T500mAL250V 2只

● 安全注意事項 -----

1. 本機所用電源電壓必須與機器後板標示的電壓相符，如長時間不使用时，應將電源插頭從交流插座拔下。
2. 本機長時間工作时溫度較高，請勿在本機上放置物品或將本機放置在靠近暖氣等有熱源的地方。
3. 本機輸出端不允許短路或空載，以免損壞機器。
4. 為避免遭電擊請勿擅自打開機蓋，內部無任何使用者操作部分，如須維修，請在專業人員指導下進行。
5. 本機嚴禁遭水滴或水濺，不要放置花瓶等裝滿液體的物品，以免引起觸電或損壞機器。
6. 每隔一段時間可用軟布清理面板與外殼，切忌使用化學試劑擦拭。
7. 請勿在電源線破損的情況下使用本機。
8. 搬運中注意輕拿輕放，避免損壞機器。

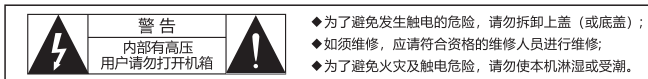

雷電箭頭用來提醒使用者注意產品殼內未經絕緣的危險電壓。這些電壓值相當大，會有觸電危險。



警吶標記用來提醒使用者注意設備說明書中提到的重要操作說明和維修（服務）說明。



本產品適用於海拔2000米及以下和非熱帶氣候條件下使用

建議：本產品採用本公司原廠零件設計，已達最佳設計使用效果，對使用非本公司原廠零件發生的故障，導致本產品的任何損壞，均不在保修範圍之內。請保留全部包裝材料，需要搬運時重新打包。請及時填好產品保修卡，寄回本公司，以便享受全面周到的售後服務。

注意：在插上電源插頭之前，務必仔細核對本機后面板標示的電壓是否與當地的電壓相符。若您發現標示電壓與當地電壓不符，請與經銷商或珠海斯巴克電子設備有限公司聯繫。

● 本机特点 -----

- ◆ 纯胆、纯手工制作，电子管电路采用手工搭棚焊接制作。
- ◆ 采用专为本机研制的高品质宽频响EI输出变压器。
- ◆ 采用专为本机研制的高品质EI电源变压器。
- ◆ 采用RCA 17AX4GT整流管负责电压放大级独立供电。
- ◆ 采用分级独立供电，电压放大电路采用独立稳压供电，有效降低对功率放大电路电源的干扰，保证电路性能最优，音质最佳。
- ◆ 单端甲类电路设计，确保音乐原汁原味，尽显单端放大电路的独特韵味。
- ◆ 整机采用NOS古董管，重播音乐时透着古董管特有的醇厚和温润。
- ◆ 电压放大级使用Amperex ECF82/6U8真空管。
- ◆ 功率放大级使用Amperex 17BF11真空管做单端纯甲类功率放大。
- ◆ 配备高品质Neutrik 6.35mm非平衡、Nippon Dics 4.4mm平衡、Neutrik 4PIN平衡耳机插座。
- ◆ 具备高、中、低三种阻抗选择，完美匹配各种耳机阻抗，发挥最佳效果。
- ◆ 具备XLR、RCA两组线路输入端子。
- ◆ 强劲输出功率，轻松推好高阻抗的高端耳机。
- ◆ 采用ALPS-27型高档音量电位器。
- ◆ 开机延时功能（约60秒）。
- ◆ 优异的电子管避震效果，给你带来真实的音质享受。
- ◆ 内部各单元合理布局及有效的隔离屏蔽，保证整机优良性能。
- ◆ 方便安装的拔插式真空管防护罩。

● 技术参数 -----

项目		规格参数
【额定输出功率】	STD非平衡输出	330mW+330mW (L) ; 550mW+550mW (M) ; 750mW+750mW (H)
	4.4 BAL.平衡输出	200mW+200mW (L) ; 300mW+300mW (M) ; 270mW+270mW (H)
	4PIN BAL.平衡输出	800mW+800mW (L) ; 900mW+900mW (M) ; 1000mW+1000mW (H)
【频率响应】	20Hz~50kHz ±3dB	
【总谐波失真】	0.2% (1kHz, 100mW; 额定输出功率小于5%)	
【灵敏度】	450mV~600mV	
【信噪比】	100dB (A计权)	
【耳机阻抗匹配】	L: 8~64Ω; M: 65~250Ω; H: 251~600Ω	
【耳机输出插座】	6.35mm非平衡耳机插座; 4.4mm平衡耳机插座; 4PIN平衡耳机插座	
【输入阻抗】	RCA: 25KΩ; XLR: 10KΩ	
【输入端子】	一组RCA; 一组XLR	
【使用真空管】	Amperex ECF82/6U8×2、Amperex 17BF11×2、RCA 17AX4GT×1	
【体积】	270mm×247mm×143mm	
【净重】	10KG	
【主保险管】	~220V-240V: T500mAL250V; ~100V-120V: T1AL250V	
【整机消耗功率】	60W	
【工作条件】	温度: 0°C~40°C 湿度: 20%~80%	
【储存条件】	温度: -20°C~70°C 湿度: 20%~90%	

● 前面板功能说明

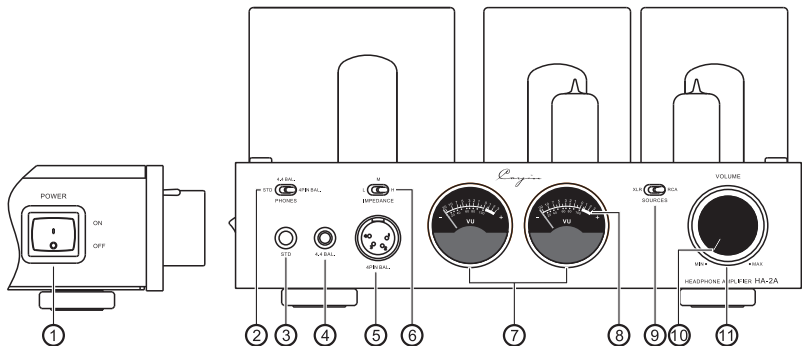

图一：HA-2A 面板图

①. 电源开关(POWER):

用于开启和关闭功率放大器电源。

②. 耳机输出选择开关(PHONES):

用于选择非平衡STD或平衡4.4 BAL.或平衡4PIN BAL.耳机输出。

③. 非平衡耳机输出插座(STANDARD):

此插座用于连接6.35mm立体声插头的耳机。

④. 4.4平衡耳机输出插座(4.4 BALANCE):

此插座用于连接4.4mm平衡立体声插头的耳机。

⑤. 四针平衡耳机输出插座(4PIN BALANCE):

此插座用于连接四针平衡立体声插头的耳机。

⑥. 耳机阻抗选择(IMPEDANCE):

用于选择相匹配的耳机阻抗, 可选择L、M、H三档的耳机阻抗。

当您使用耳机时, 可根据使用耳机的阻抗选择相匹配的阻抗档位 (L: 8~64Ω; M: 65~250Ω; H: 251~600Ω)

⑦. VU电平表:

用于显示功率放大器的输出电平。

⑧. VU电平表背光源:

开启电源开关, 此背光源点亮。

⑨. 音源输入选择开关(SOURCES):

用于选择平衡输入信号或非平衡输入信号。

⑩. 音量指示灯 (工作状态指示灯):

用于指示音量位置。开启电源开关, 延时 (约60秒) 后, 此指示灯亮。

⑪. 音量控制旋钮(VOLUME):

用于控制音量的大小, 依照顺时针方向旋转音量逐渐增大, 逆时针方向旋转音量逐渐减小。

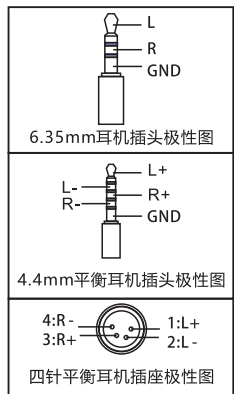

使用注意

- ◆ 如耳机插头为3.5mm, 需使用6.35/3.5mm耳机转换座。
- ◆ 收听音量和时间要适度, 以防损伤您的听觉系统。
- ◆ 使用单声道耳机插头 (TS插头), 会造成机器内部短路, 请不要使用此类耳机插头, 以免损坏机器。
- ◆ 当本机长时间不使用时, 应该将电源插头从交流电座上拔下。

● 顶面板功能说明 -----

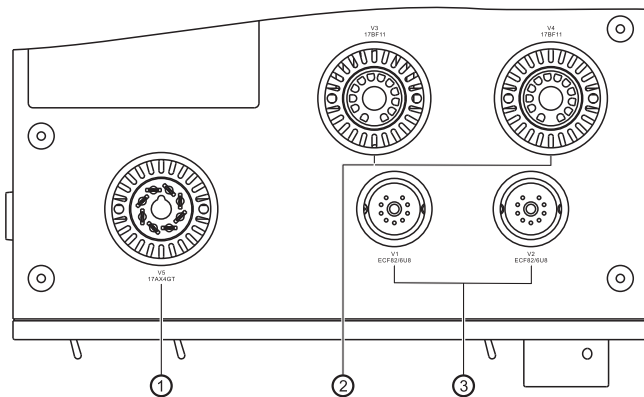

图二：HA-2A顶板图

- ①. V5: RCA 17AX4GT真空管
- ②. V3、V4: Amperex 17BF11真空管
- ③. V1、V2: Amperex ECF82/6U8 真空管

注意： ◆工作时真空管表面温度很高，小心烫伤。

◆替换真空管时，请参阅第11页<真空管安装示意图>相应真空管的安装方法，以免损坏真空管。

◆真空管应配对使用。

● 常用真空管代换表 -----

本机用真空管型号	代换真空管型号
Amperex ECF82/6U8	ECF82、6U8
Amperex 17BF11	17BF11A
RCA 17AX4GT	17AX4GTA

● 后面板功能说明

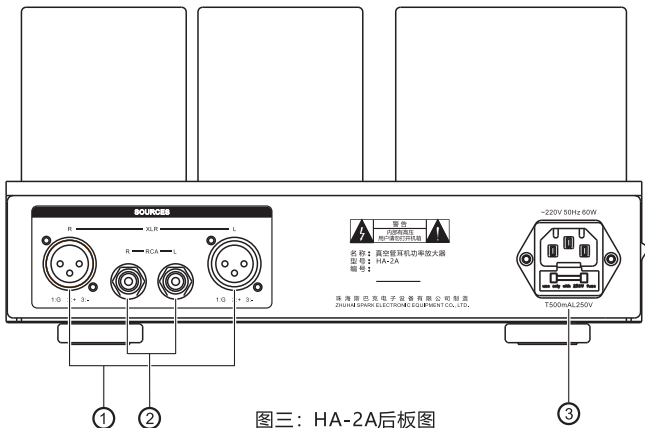

图三：HA-2A后板图

①.平衡输入端子(XLR):

用于外部平衡音频信号输入，请注意左右声道不要接反。

②.非平衡输入端子(RCA):

用于外部非平衡音频信号输入，请注意左右声道不要接反。

③.电源输入插座、保险丝座 (FUSE) :

交流电源由此输入。

保险丝座内安装有保险丝。

！更换保险丝时请使用相同规格的保险丝。

● 安装

在您安装本机之前，请再次确认与之相关的其他设备处于正常状态。

放大器放置须注意以下事项：

- ◆ 功率放大器不要放置在阳光可直接照射或接近其他热源的地方
- ◆ 为了防止过热，应保证放大器散热孔不要被其他物品覆盖
- ◆ 应避免湿气或灰尘的侵蚀
- ◆ 放置本机时应保证与电源和其他相关设备容易连接
- ◆ 本机应放置平稳，使机脚受力均匀
- ◆ 功率放大器与四周应保持在20cm以上距离

注意：本放大器的正常工作电源为交流220V \pm 5%，请确认供电电压是否符合要求，电压过高或过低都可能令本机器不能正常工作，甚至可能危害本机器的使用寿命。

●设备连接

此处是用标准方式，将主要器材连接Cayin HA-2A的方法说明。

一、音频连接：

1. 须参照将要连接的器材附带说明书；
2. 红色连接端（R标记）用于右声道；黑色连接端（L标记）用于左声道；
3. 请勿将音频线与电源线绑在一起，否则可能会对音质产生不良影响。

二、交流电源线的连接：

连接好音源后，接通本机交流电源线。

电源插座及电源开关周围应保持适当的空间，以确保可以方便操作。

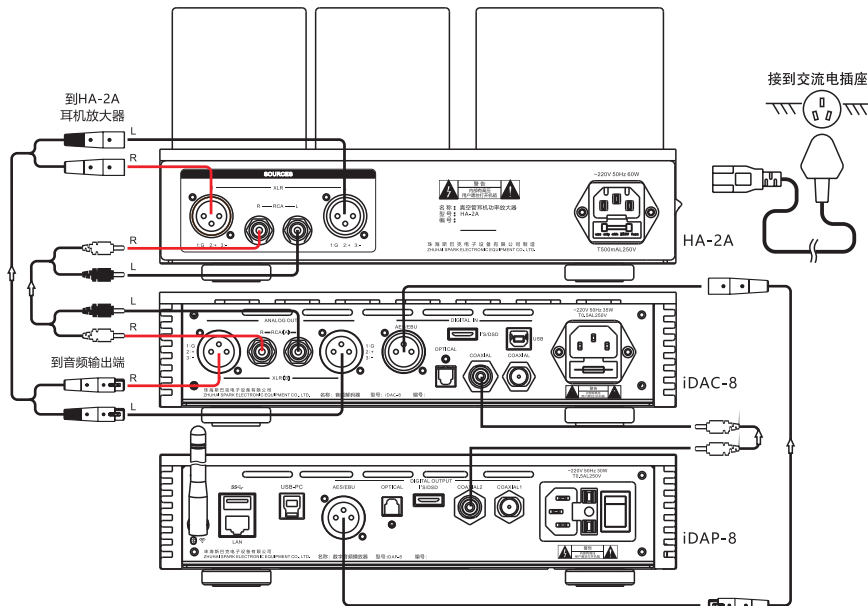

三：平衡插座：

1. 本装置的平衡插座配有专业设备的XLR插座。

其性能如下所示。

- ◆音乐信号作为平衡信号传输，不受外部干扰的影响。
- ◆专业的XLR连接器，提高了连接的可靠性。

2. 在下列两种系统中，专业的XLR连接器在内部接线。

- a. 美国系统：①PIN1：GND
②PIN2：HOT
③PIN3：COLD



- b. 欧洲系统：①PIN1：GND

- ②PIN2：COLD

- ③PIN3：HOT

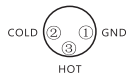

3. 本机采用a美国系统

当使用XLR连接器的电缆连接采用欧洲系统的前置放大器时，复原的信号是反相。此时，请设置使用正确相位。

●耳机连接 -----

使用6.35mm非平衡耳机

请将耳机的6.35mm插头插入到前面板的非平衡耳机输出插座(STD)上,并将耳机输出选择开关(PHONES)拨到STD档,再根据使用耳机的阻抗,将耳机阻抗选择(IMPEDANCE)拨到匹配的档位。旋转音量控制旋钮(VOLUME),将音量调整至合适位置,便可乐享醉人的音乐。

使用4.4mm平衡耳机

请将耳机的4.4mm插头插入到前面板的4.4平衡耳机输出插座(4.4 BAL.)上,并将耳机输出选择开关(PHONES)拨到4.4 BAL.档,再根据使用耳机的阻抗,将耳机阻抗选择(IMPEDANCE)拨到匹配的档位。旋转音量控制旋钮(VOLUME),将音量调整至合适位置,便可乐享醉人的音乐。

使用4PIN平衡耳机

请将耳机的4PIN插头插入到前面板的4PIN平衡耳机输出插座(4PIN BAL.)上,并将耳机输出选择开关(PHONES)拨到4PIN BAL.档,再根据使用耳机的阻抗,将耳机阻抗选择(IMPEDANCE)拨到匹配的档位。旋转音量控制旋钮(VOLUME),将音量调整至合适位置,便可乐享醉人的音乐。

注意: 切换耳机时,请将音量调至最小位置。

●开机

开机前请再次确认各种连接正确，供电电压是否正常。

- ◆ 开启电源开关，VU电平表背光源亮。
- ◆ 延时（约60秒）后，音量旋钮指示灯亮，表示本机已经正常工作。若音量旋钮指示灯一直熄灭，表示机器内部存在故障，请立刻关掉电源，与经销商或本公司联系。
- ◆ 你的音源正常工作后，通过选择正确的音源通道，调节音量控制旋钮至合适音量，你就可以享受到高质量的音乐了。

注意：◆ 在您的音响系统工作时，切勿插拔信号线，以免损坏本机和其他设备。

- ◆ 在每次关闭电源开关后，应间隔2分钟才能开启电源开关，以免损坏本机和其他设备。

●机器保养

阅读说明书——使用电器前，请仔细阅读安全操作提示与产品说明书，以保证安全及正确操作。

保存说明书——请保存好安全操作提示与产品使用说明书，以便将来查阅。

警告标志——请注意不要将产品编号撕掉或擦掉。

操作步骤——请严格按照使用说明书的操作步骤或使用步骤进行操作。

使用配件——使用非本产品制造商提供的附件时(如电源线、保险管等)，必须符合产品的安全要求，否则在使用不当时可能会造成危险。

放置——请勿将本产品放置在不平坦的推车、货架、三脚架、挂墙架或简易书架上，产品有可能因此倒下来砸伤小孩或大人，产品也会被摔坏。

电源——本产品只能使用本身标示的交流电源类型，如果你不清楚家中的电源类型，请与经销商或供电部门联系。

线路负载过量——给本产品供电的电源插座同时连接其它电器时，请注意负载不要过量，否则可能造成火灾或电击。

维修服务——请勿随意拆开机器调整内部元件参数，以防触电。

故障排除——如果您在使用产品过程中遇到问题，可以按第10页《一般故障处理》方法分析或排除故障

●保修

1. 整机保修一年（真空管保修半年）。
2. 为使保修生效，客户必须在购买本机十日内将填好的保修卡交于经销商或寄回珠海海斯巴克电子有限公司。
3. 在责任期限内，本公司保证产品在正常使用下出现的质量问题的维修，条件是该产品得到返修许可并运到保修单位或运回珠海海斯巴克电子有限公司。
4. 如果没有得到本公司允许私自打开机器，保修承诺失效。

注：本说明书中的信息如有更改，恕不另行通知。

●一般故障处理-----

为了使设备能维持其卓越性能，请注意做好保养和正确操作。不正确的操作会导致误认为故障，如果本装置有问题请检查下列事项。有时候问题可能出在其他设备上，请检查其他设备以及有关的连接线路，如果故障未被消除，请与星巴克公司经销商或销售部联系。

故障现象		可能的原因	解决方法
开 机 无 声	VU电平表 背光源不亮	电源线未连接	检查供电电路及电源线
		主保险管已断	更换相同规格的保险
	VU电平表 背光源亮	无信号输入	检查音源是否正常 检查本机音源输入选择是否正确
		音量电位器在最小位置	调整音量旋钮到合适位置
		信号线没有连接好	重新连接信号线
		耳机插头没有连接好	确保耳机插头可靠连接
		耳机输出选择开关选择错误	确认耳机输出选择开关是否正确
		音源输入选择开关选择错误	确认音源输入选择开关是否正确
噪音过大	输入信号线地线开路或接触不良	更换或重新连接信号线	
	机器内部故障	请与经销商或保修单位联系	
音场定位感不好	信号输入的声道接反 耳机输出线的声道接反	按要求重新接线	

●真空管安装示意图

小九脚真空管安装示意图

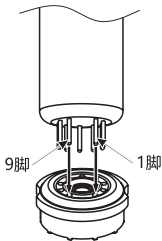

适用真空管：12AU7(ECC82)、12AX7(ECC83)、ECF82、6U8、12BH7、12AT7(ECC81)、6922 (ECC88)等小九脚真空管。

▲ 请注意

安装小九脚真空管时，注意真空管的针脚与管座的针孔对齐，否则插错将使机器无法正常工作，引起真空管损坏，严重时可能导致机器故障。

正确换插真空管的方法：

安装小九脚真空管时，将真空管的针脚与管座的针孔对齐，上下垂直拔插安装（如上图所示）。

八脚真空管安装示意图



适用真空管：KT150、KT170、KT88、6550、EL34、6V6、6SN7、6SL7、5AR4、17AX4GT等八脚真空管。

▲ 请注意

安装八脚真空管时，注意真空管的定位销与管座的定位孔对齐，否则插错将使机器无法正常工作，引起真空管损坏，严重时可能导致机器故障。

正确换插真空管的方法：

安装八脚真空管时，将真空管的定位销凸台与管座定位孔的凹槽对齐，上下垂直拔插安装（如上图所示）。

十二脚真空管安装示意图

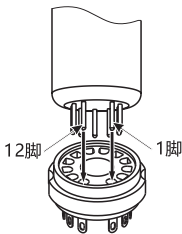

适用真空管：17BF11、17BF11A等十二脚真空管。

▲ 请注意

安装十二脚真空管时，注意真空管的针脚与管座的针孔对齐，否则插错将使机器无法正常工作，引起真空管损坏，严重时可能导致机器故障。

正确换插真空管的方法：

安装十二脚真空管时，将真空管的针脚与管座的针孔对齐，上下垂直拔插安装（如上图所示）。

大四脚真空管安装示意图

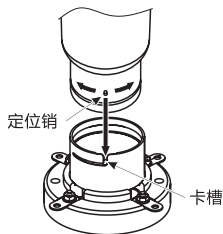

适用真空管：845、805、211等大四脚真空管。

▲ 请注意

安装大四脚真空管时，将真空管定位销与管座卡槽对齐，再顺时针方向旋转45°卡紧。定位销脱落或缺失时，严禁安装真空管。否则插错管脚将使机器无法正常工作，严重时可能导致机器故障。

正确安装真空管的方法：

安装大四脚真空管时，将真空管定位销与管座卡槽对齐放入，再顺时针旋转45°卡紧。（如上图所示）。取出大四脚真空管时，将真空管逆时针旋转45°，松动后向上取出。

Cayin

HA-2A HEADPHONE AMPLIFIER

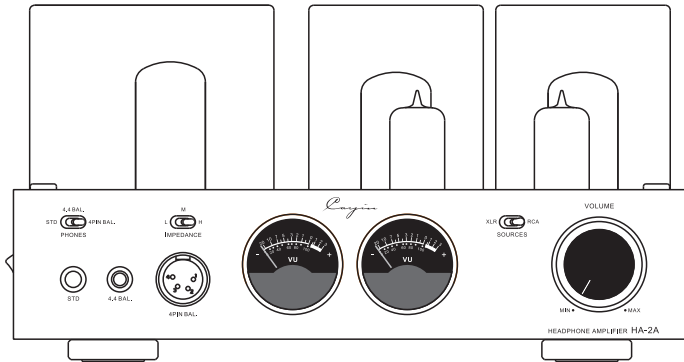

User's Manual

Thank you for choosing Cayin HA-2A Headphone Amplifier

We have inserted protective foam inside the Vacuum Tube Cage in order to protect the vacuum tubes during transportation. Please remove these foams before you connect the amplifier into your sound system. Fail to do so might cause serious damage to the amplifier or disaster such as fire accident.

We have prepared this user manual to help you understand the features and get familiar with the operation of the amplifier. We suggest all customers read through this manual before they start to use the device.

Table of Contents

Table of Contents	12
Package Contents	13
Product Features	14
Specifications	15
Safety Precautions	16
Front Panel Functional Description	17
Rear Panel Functional Description	18
Top Panel Functional Description	19
Installation	20
Vacuum Tube Substitution	20
Connect to Audio Equipment	21
Connect to Headphones	22
Basic Operation	23
Maintenance	24
Troubleshooting	25
How to Install Vacuum Tubes.....	26

Notice:

This amplifier is designed, optimized and manufactured by factory designated components. Cayin reserves the right to void the warranty of the product in case of unauthorized repair, modification or change to the product, and we shall not responsible to any failure or damage caused by replacement of non-designated components.

● Package Contents -----

Please place the box in upright position according to the marking of the package. Please examine the product package before you open it, the package should be free from any physical damage or water stain. You should find the following items when you open the package:

1. Cayin HA-2A x1
2. User' s Manual x1
3. AC Power Cord x1
4. Spare Fuses x2 (~ 220V-240V : T500mAL250V; ~ 100V-120V: T1AL250V)

Recommendation

Please keep all packaging materials for future use as you may need to repackage the amplifier in the future. Please fill in the product warranty card immediately and mail it to authorized dealer to safeguard your after-sales service.

Note: Please make sure the AC voltage of your local power supply match the voltage information printed on the back panel before you power up the amplifier. Incorrect input voltage setting will cause damage to the machine or might even lead to serious household accident. Cayin reserves the right to refuse service or responsibility on related instances. If the marked voltage is different from your local power supply voltage, please contact your authorized dealer or Zhuhai Spark Electronic Equipment Co., Ltd.

Attention: the product package should include only the items in the list above.

● **Product Features** -----



- ◆ Point to point wiring with premium grade of wires. The entire circuitry is hand-wired by skillful craftsman.
- ◆ Matched-pair custom build EI output transformers.
- ◆ Custom build EI power transformer.
- ◆ 17AX4GT from RCA are used as Tube Rectifier providing stable and clean power supply to the Voltage Amplification Stage.
- ◆ Multi-stage independent power supply voltage amplification employs independent regulator design minimum ripple effect of power interference ensure outstanding audio performance, free from any grain and hardness.
- ◆ Dedicated implementation of single-ended amplification circuit offer simple, pure and devoted music presentation.
- ◆ All tubes used for HA-2A are NOS Tubes with an unique mellow and warmth.
- ◆ Amperex ECF82/6U8 are used for voltage amplification.
- ◆ Amperex 17BF11 are used for power amplification.
- ◆ High quality Neutrik 6.35mm single-ended headphone, NIPPON DICS 4.4mm balanced headphone, and Neutrik 4-pin balanced headphone are included.
- ◆ In-house designed output transformers provide three set of impedance matched outputs (High, Mid, Low) from 8Ω to 600Ω at your direction.
- ◆ Two sets of line inputs: XLR Balanced and RCA Single-ended.
- ◆ Strong output power to match with wide range of headphone in the market.
- ◆ High performance Alps Potentiometer offers durable, high-precision Volume Control.
- ◆ Soft start function (about 60 seconds).
- ◆ Special shielding and anti-shock design.
- ◆ Design with an innovative circuit layout and highly effective shielding consideration, the components will function at premium environment to ensure high quality audio performance form the amplifier.
- ◆ Equipped with easily-installed tube cover for protection.

● Specifications-----

ITEM		SPECIFICATIONS
Rated Output	STD	330mW+330mW (L) ; 550mW+550mW (M) ; 750mW+750mW (H)
	4.4 BAL.	200mW+200mW (L) ; 300mW+300mW (M) ; 270mW+270mW (H)
	4PIN BAL.	800mW+800mW (L) ; 900mW+900mW (M) ; 1000mW+1000mW (H)
Frequency Response		20Hz~50kHz ±3dB
TH+D		0.2% (1kHz, 100mW; 5% Under Rated Power)
Sensitivity		450mV~600mV
S/N Ratio		100dB (A-Weighted)
Headphone Impedance		L: 8~64Ω; M: 65~250Ω; H: 251~600Ω
Headphone Connectors		6.35mm x1 ; 4.4mm BALANCEx1; 4pin XLR x1
Input Impedance		RCA: 25KΩ; XLR: 10KΩ
Input Connector		RCAx1; XLRx1
Tube used		Amperex ECF82/6U8×2, Amperex 17BF11×2, RCA 17AX4GT×1
Dimension		270mm×247mm×143mm
Net Weight		10KG
Fuse		~ 220V-240V: T500mAL250V; ~ 100V-120V: T1AL250V
Power Consumption		60W
Working Condition		Temp: 0°C ~ 40°C Humidity: 20% ~ 80%
Storage Condition		Temp: -20°C ~ 70°C Humidity: 20% ~ 90%

● Safety precautions-----

1. Unplug the power cord if you are not going to use the amplifier for an extended period of time, and keep the machine in proper condition.
2. Tube amplifier will built-up its operation temperature after long hours of operation. Please keep the amplifier at a well-ventilated environment and do not cover the amplifier or blocked the vents. Poor ventilation will lead to excessively high operation temperature and can cause malfunction or fire.
3. To avoid damaging the amplifier, you must connect a source device to the input terminals before you select that as the active input of your HA-2A.
4. To avoid damaging the amplifier, short circuit among the output terminals are strictly forbidden.
5. Do not attempt to service this product yourself. Opening the cover may expose you to electric shock or other hazards.
6. Do not attempt to disassemble the machine. Cayin reserves the right to void the warranty of the product in case of unauthorized repair, modification or change to the product. All service and maintenance must be conducted by authorized service technician.
7. The amplifier must be keep away from water dripping or water splitting, do not place any objects filled with liquids such as vases or some others on the top or around the amplifier.
8. Please disconnect power cable before you attempt to clean the machine. Please use soft clean cloth to wipe clean the chassis, do not use volatile solution or corrosive to clean product.
9. Please handle with care, avoid tempering to the machine.

	<p>CAUTION RISK OF ELECTRIC SHOCK DO NOT OPEN</p>	
---	---	--

- ◆ To reduce the risk of electric shock, do not remove the cover.
- ◆ No user serviceable parts inside. Refer servicing to qualified service personnel.
- ◆ To reduce the risk of fire or electronic shock, do not expose the unit to rain or moisture.



This symbol warns the users that uninsulated voltage within the unit may be sufficient to cause electrical shock. It is dangerous to make any kind of contact with any part inside the unit.



This symbol alerts the users that important information concerning the operation and maintenance of this unit has been provided. The information should be read carefully to avoid problems.

● Front Panel Functional Description -----

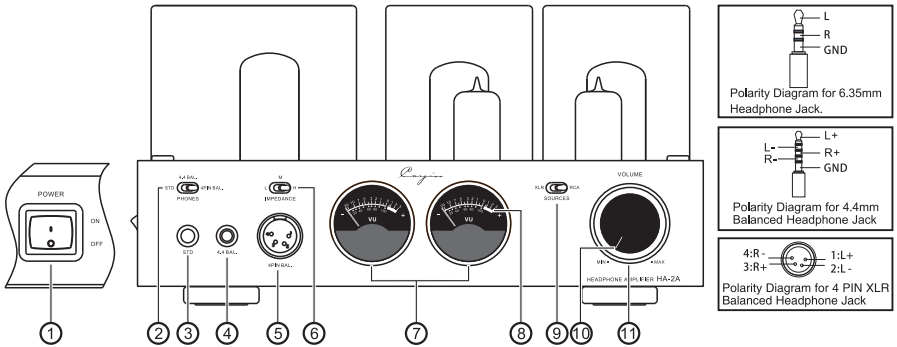

Diagram 1: HA-2A Front Panel

- ①. **Power On/Off:** Turn on and off the amplifier. Press “down” the button to turn on the amplifier, Press again the button will resume to original position and the amplifier will power off.
- ②. **Headphone Output Selector:** With the switch you can select the suitable type of headphone output. HA-2A offers three types output.
 - ③. **STANDARD:** Output for headphones terminated in 6.35mm TRS connector
 - ④. **4.4 Balance Output:** 4.4 balance output for headphone terminated in 4.4mm connector.
 - ⑤. **4PIN BALANCE:** Output for headphones terminated in 4pins XLR connector
- ⑥. **IMPEDANCE:** Select the most desirable impedance-matched output from the amplifier and three options offered: (L:8~64Ω; M:65~250Ω; H: 251~600Ω)
- ⑦. **VU Meter:** Monitor output level of the amplifier
- ⑧. **VU Meter Backlight:** Turn on the Amplifier and the Backlight will light up.
- ⑨. **SOURCES:** Select Balanced or Single-ended Input
- ⑩. **Volume Level Indicator (Operation Indicator):** Used to indicate the volume position. Once powered on the indicator will light up after soft-start of 60 seconds.
- ⑪. **Volume Knob**
Used to control volume

Attention:

- ◆ If you want to connect a 3.5mm terminated headphone to the amplifier, you need a 3.5mm to 6.35mm adapter (not included in the package).
- ◆ Listening through headphones at a high volume for extended periods of time can result in hearing impairments.
- ◆ Please do not use mono (TS) phone plug with this amplifier as this might cause serious damage such as short circuit in the amplifier.
- ◆ Please unplug the power plug from AC power circuit if the amplifier is not used for a long time

● Rear Panel Functional Description -----

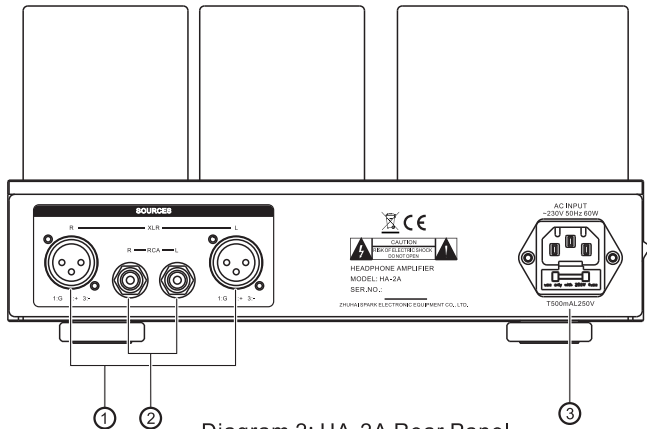

①. Balanced input (XLR)

Connect a balanced audio input to the amplifier. Please make sure the left and right channel is connected correctly

②. Single-ended input (RCA)

Connect a single-ended audio input to the amplifier. Please make sure the left and right channel is connected correctly

③. AC Power Input with Fuse Holder: please replace fuse with the same specification

Attention:

Please make sure the AC voltage of your local power supply match the voltage of the amplifier. Cayin will not be responsible for the damage or accidents such as fire caused by incorrect input voltage

● Top Panel Functional Description -----

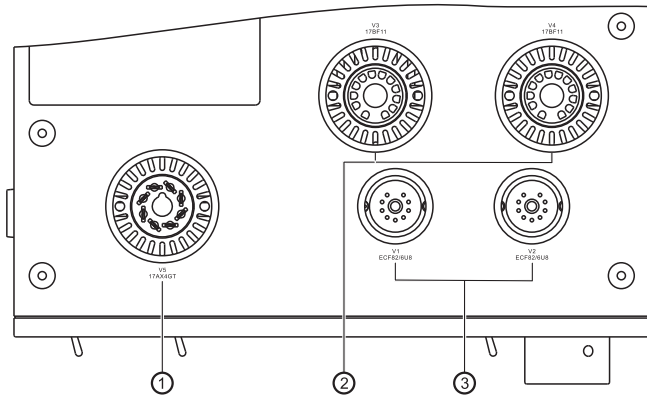

Diagram 3: HA-2A Top Panel

- ①.V5: RCA 17AX4GT Vacuum TUBE
- ②.V3、 V4: Amperex 17BF11 Vacuum TUBE
- ③.V1、 V2: Amperex ECF82/6U8 Vacuum TUBE

Attention:

- ◆The vacuum tube will become very hot during operation, please be careful and don't get burned.
 - ◆Please turn off the amplifier for 20 minutes before replacing the vacuum tube. Hold the base of vacuum tube firmly and to avoid damaging the fragile part of the vacuum tube.
 - ◆When install vacuum tube to the amplifier, position the vacuum tube correctly according to the alignment pin before push the vacuum tube base into the socket.
-

● Installation -----

Please make sure all associated equipment are in perfect working condition before you install the amplifier

Please pay attention to the following details when you install the amplifier.

- ◆ Do not place the power amplifier under direct sunlight or near other heat sources.
- ◆ To prevent the amplifier from overheating, please keep the amplifier at a well-ventilated environment and do not cover the amplifier or blocked the vents.
- ◆ Avoid moisture, keep the amplifier from dust if possible.
- ◆ Make sure the amplifier are setup at a location that can be connected to the AC power supply and other audio equipment conveniently.
- ◆ Place the amplifier at a flat surface, make sure all four supporting tips are evenly loaded.
- ◆ Please keep amplifier not less than 15cm away from and the wall.

● Vacuum Tube Substitution-----

Vacuum Tube	Substitution
Amperex ECF82/6U8	ECF82、 6U8
Amperex 17BF11	17BF11A
RCA 17AX4GT	17AX4GTA

● Connect to Audio Equipment -----

This section will illustrate how to connect audio equipment to the HA-2A amplifier.

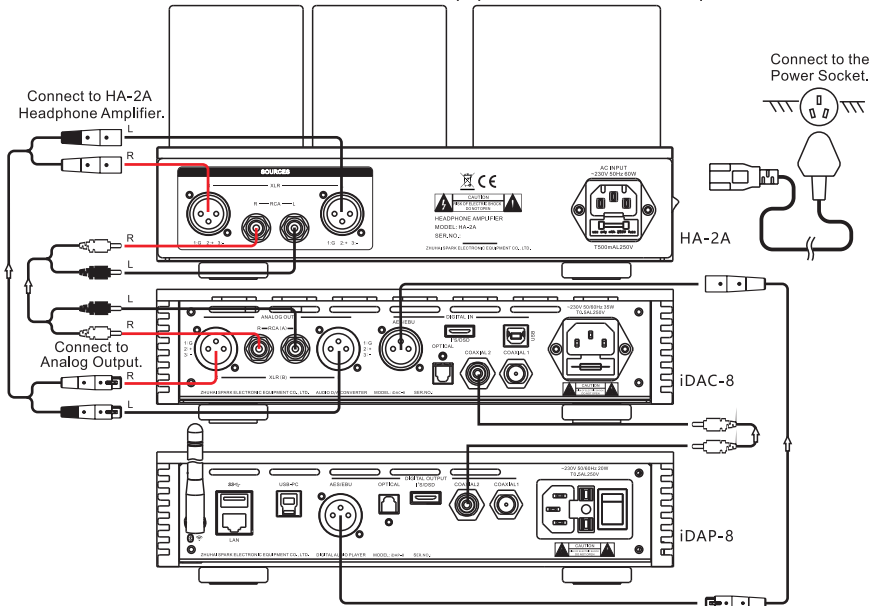

BALANCE Socket:

- The BALANCE socket is with XLR input. The functions are following:
 - ◆ Music signal is transferred as balance signal without the outside disturbance.
 - ◆ Professional XLR connectors are used to raise reliability of connection.
- In the following two systems, professional XLR connectors are used for inside connection.
 - USA System:
 - ①PIN1 : GND;
 - ②PIN2 : HOT;
 - ③PIN3 : COLD
 - European System:
 - ①PIN1 : GND;
 - ②PIN2 : COLD;
 - ③PIN3 : HOT

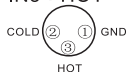
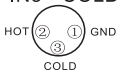

- This amplifier uses the USA System.

If the XLR balance connector is used by European system, the restored signal of pre-amplifier or main amplifier will be inverse. Therefore, please setup the correct phase in advance.

Attention to Audio Connection:

- Please refer to the manual of associated equipment whenever necessary.
- Do not connect the power cord until all equipment are properly connected
- “R” indicates the right channel; “L” indicates left channel.
- Please make sure all connectors are securely installed. Bad connection might cause noise and degrade in audio performance, or even damaging your equipment.
- Please do not tie the power cord, audio interconnects, and speaker cable together or run them in parallel because this will produce adverse effect on audio performance.

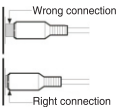

Note: Please make sure + and -, left and right are connected properly.

● Connect to Headphones -----

Selecting Headphone Connection

HA-2A provided three types of headphone output: 4-pins XLR for balanced, 4.4mm Balanced, 6.35mm for singled-end, we have optimized the headphone amplifier to perform satisfactory for all outputs, user are free to use any headphone output according to their need without worrying one is better than the other.

Single-ended Headphone Connection

- HA-2A provides one set of 6.35mm headphone output, the pin definition of the headphone connector is as illustrated.
- Headphones terminated with 3.5mm connector will require a 3.5mm to 6.35mm adapter in order to use it with this headphone amplifier.

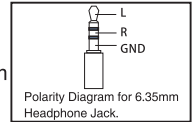

4.4mm Balanced Headphone Connection

- HA-2A provides one set of 4.4mm headphone output, the pin definition of the headphone connector is as illustrated.
- Headphones terminated with 2.5mm connector will require a 2.5mm to 4.4mm adapter in order to use it with this headphone amplifier.

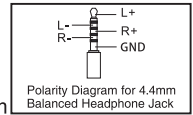

XLR Balance Headphone Connections

- HA-2A provide one set of 4-pin XLR headphone output, the pin definition of the XLR connector is as illustrated.
- Headphones terminated with dual XLR (3-pins), 4.4mm or 2.5mm balanced headphone connectors will require corresponding XLR4 adapter in order to use it with this headphone amplifier.

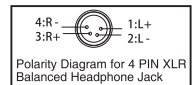

IMPEDANCE matched output

- Headphones are currently available from 8Ω to 600Ω, in view of this wide range of impedance rating, HA-2A provides three sets of impedance matched outputs (L:8~64Ω; M:65~250Ω; H: 251~600Ω) to ensure the headphone amplifier can handle vast variety of headphones satisfactory.
- We recommend users to start with the output setting that match the impedance rating of your headphone.
- It is technically safe to select any impedance setting for your headphone. You can try other impedance setting without worrying causing any damage to your headphone.

Attention:

- ◆ Balanced headphones can convert into single-ended headphone with appropriate converter and use the 6.35mm headphone output.
- ◆ Single-ended headphone cannot use an adapter to plug into the XLR4 balanced headphone output of the HA-2A, it can cause damage to your headphone and/or headphone amplifier.
- ◆ Turning the volume to the minimum when you exchange the Headphone.

Attention:

- ◆ Connect power cord after all equipments are well connected.
 - ◆ It is normal that the transformers will emit heat when the amplifier is used for long hours
 - ◆ Please unplug the power plug if you won't use the amplifier for a long time
-

● Basic Operation -----

Please make sure all connections are correct and power supply voltage is stable before turn on the amplifier.

1. Turn on the Amplifier and the VU Meter will light up.
2. In about 60 seconds after the soft-start the Volume Level Indicator will light up steadily and then the Amplifier is ready for operation. If the Volume Level Indicator does not light up the Amplifier is malfunction. Please turn off the amplifier and contact your local dealer for service support.
3. The tubes regulated power supply might require around 30-60 seconds to ramp up the voltage gradually, it is normal if you heard ting-ting noise from your headphone or speaker during this time.
4. The vacuum tube might require 10 minutes of warm up before they reach optimum performance.
5. Select your input source: XLR for balanced input, RCA for single-ended input.
6. If you are using single-ended headphone, insert the 6.35mm connector of your headphone into the STANDARD headphone output on the front panel. Switch the headphone output selector (PHONES) to STD.
7. If you are using a 4.4mm balanced headphone, insert the 4.4 connector of your headphone into the 4.4 BALANCE headphone output on the front panel. Switch the headphone output selector (PHONES) to 4.4 BAL.
8. If you are using a 4pin XLR balanced headphone, insert the XLR4 connector of your headphone into the 4 PIN BALANCE headphone output on the front panel. Switch the headphone output selector (PHONES) to 4 PIN BAL.
9. Select the appropriate output (L, M, or H) on the IMPEDANCE switch according to the specification of your headphone for optimized performance.
10. Adjust Volume to appropriate level and enjoy your music.

Attention:

- ◆ Please do not disconnect your interconnect when the amplifier is operating, this might cause damage to the amplifier or associated equipment
 - ◆ You can swap headphones during playback, but to avoid damaging your sensitive headphone and protect your hearing, please turn the volume down to 0 when you unplug or plug in another pair of headphone.
 - ◆ If you have turn off the amplifier, please wait 2 minutes before you turn in on again, or it might cause damage to the vacuum tubes.
-

● **Warranty Service**-----

1. The Product is warranted for a period of twelve (12) months from the date of original purchase (the “Warranty Period”). Replacement Products are warranted for the remainder of the original twelve (12) month warranty period. Six-month warranty on stock vacuum tubes.
2. The defective product must be returned to our authorized agent or Zhuhai Spark Electronic Equipment Co., Ltd (the “Company”) for service. You must receive approval from our authorized dealer or the “Company” before you send out the defective product.
3. Do not attempt to disassemble the machine without prior approval of the “Company” otherwise we reserves the right to void the warranty of the product

● **Maintenance** -----

Read the Manual: to operate the amplifier correctly, please read this user's manual carefully to understand product features and safety precaution .

Keep the Manual: Please keep this manual properly for future reference.

Signage: Do not tear off or rub away the serial number.

Operation: Please follow the operations in this manual strictly.

Accessories: If you are going to use non-factory supplied accessories such as power cord or fuse, please make sure they are fully compatible with the safety requirements otherwise might cause damage due to improper usage.

Placement: The amplifier is heavy and the vacuum tubes are fragile, please place the amplifier on a stable, flat surface, preferably a strong cabinet or rack. If the amplifier falls down because of insecure placement, the amplifier will suffer damage and possibly causing serious household accident.

Power Supply: Please make sure your household AC power supply matches the power requirement of your amplifier. If you are uncertain about the power supply situation, please contact your authorized dealer or local power supply institutions.

Overloading: If you have to connect the amplifier to a power stripe or multi-socket, please make sure the loading is within safety consideration. Overloaded power connection might lead to electric shock or fire accident.

Warranty Service: Do not attempt to disassemble the machine or modify the component, this will void the warranty service and might expose yourself to electric shock.

Troubleshooting: If you encounter any abnormal behavior during setup or playback, please refer to the advices in next pages of this manual to recover your amplifier back to normal operation. If you fail to rectify the problems after that, please contact your authorized dealer for technical support.

● Troubleshooting -----

Please follow the instruction in the manual in order to keep the amplifier under proper working condition. If the amplifier is not functioning as intended, please check according to following tip to look for the possible reason.

Problem		Cause	Solution
No Sound after power on	VU Meter does not light up.	Power is not connected	Connect the power cord securely. Check the main power supply.
		Main fuse is out.	Replace fuse with same specification
	VU Meter lights up.	NO input signal .	Check source equipment is working Select input source correctly
		Volume at minimum position	Turn up volume
		Interconnect not properly connected	Connect all cables securely
		Headphone cable not properly connected	Connect headphone cable properly
		Headphone output not specified correctly	Select headphone output correctly
		Source Selector wrong Selected	Select the correct Source Input.
Excessive noise	Input source wrongly connected	Install interconnect properly	
	Interconnect grounding disconnected	Replace interconnect	
	Equipment malfunction	Contact authorized dealer for technical support	
Soundstage and imaging not focused	Left and right channel of source equipment reversed	Reinstall related cabled correctly	
	Headphone cable polarity reversed		
	Speaker cable polarity reserved		

● How to Install Vacuum Tubes-----

How to Install 9-Pin Vacuum Tubes

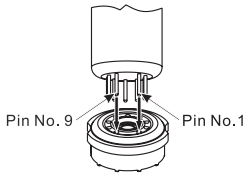

Applicable vacuum tube:

12AU7(ECC82), 12AX7(ECC83), ECF82, 6U8, 12BH7, 12AT7(ECC81), 6922 (ECC88) etc. 9-Pin vacuum tubes.

Instructions to Change and Install the vacuum tubes:

To install a nine-pin vacuum tube, align the pins of the vacuum tube with the holes of the tube socket and insert the tube vertically up and down (as shown in the figure above).

▲ Please note that when installing the nine-pin vacuum tube, pay attention to the alignment of the vacuum tube pins with the holes of the tube socket. Otherwise wrong insertion will cause damage to the vacuum tube and prevent the amplifier from working properly, which may lead to failure of the amplifier.

How to Install 8-Pin Vacuum Tubes

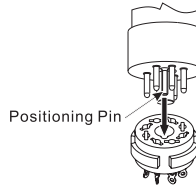

Applicable vacuum tube:

KT150, KT170, KT88, 6550, EL34, 6V6, 6SN7, 6SL7, 5AR4, 17AX4GT, etc. 8-pin vacuum tubes.

Instructions to Change and Install the vacuum tubes:

To install an eight-pin vacuum tube, align the positioning pin of the tube with the grooves in the positioning holes of the tube socket, and install the tube by pulling up and down vertically (as shown in the figure above).

▲ Please note that when installing the eight-pin vacuum tube, pay attention to the alignment of the vacuum tube positioning pin with the positioning hole of the tube socket. Otherwise wrong insertion will cause damage to the vacuum tube and prevent the amplifier from working properly, which may lead to failure of the amplifier.

How to Install 12-Pin Vacuum Tubes

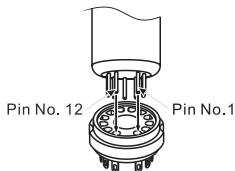

Applicable vacuum tube: 17BF11, 17BF11A etc. 12-Pin vacuum tubes.

Instructions to Change and Install the vacuum tubes:

To install a twelve-pin vacuum tube, align the pins of the vacuum tube with the holes of the tube socket and insert the tube vertically up and down (as shown in the figure above).

▲ Please note that when installing the twelve-pin vacuum tube, pay attention to the alignment of the vacuum tube pins with the holes of the tube socket. Otherwise wrong insertion will cause damage to the vacuum tube and prevent the amplifier from working properly, which may lead to failure of the amplifier.

How to Install Big 4-Pin Vacuum Tubes

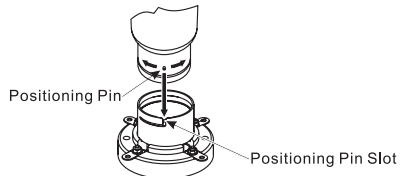

Applicable vacuum tube: 845, 805, 211 etc. 4-pin vacuum tubes.

Instructions to Change and Install the vacuum tubes:

To install the big four-pin vacuum tube, align the vacuum tube positioning pin with positioning pin slot of the tube socket and then rotate 45° clockwise to tighten. (As shown in the picture above). To take out the big four-pin vacuum tube, turn the tube 45° counterclockwise and take it out upward after loosening.

▲ Please note that when installing the big four-pin vacuum tube, pay attention to the alignment of the vacuum tube positioning pin with positioning pin slot of the tube socket and then rotate 45° clockwise to tighten. It is strictly forbidden to install the vacuum tube when the positioning pin is off or missing. Otherwise wrong insertion will cause damage to the vacuum tube and prevent the amplifier from working properly, which may lead to failure of the amplifier.

欢迎扫描二维码访问：
Please follow us :



官网



微信号

Cayin Website



新浪微博

Cayin SINA Weibo



Cayin Facebook

珠海斯巴克电子设备有限公司
Zhuhai Spark Electronic Equipment Co., LTD

www.cayin.cn

电话: 0756-3828711 传真: 0756-3828722 E-mail: market@cayin.cn

地址: 广东省珠海市联港工业区联发路9号

邮编: 519045

Tel: : 0756-3828711 Fax : 0756-3828722 Email: market@cayin.cn

Address: 9 Lianfa Road, Liangang Industrial Park, Shuanglin Zone, Zhuhai,
Guangdong, China

Post Code : 519045

重要说明:  为珠海斯巴克电子设备有限公司注册商标! 购买是请认清此标志, 提防假冒!

V1.0_20231226