



INSTRUCTIONS



X16E

USER MANUAL

Content

1.Safety Information.....	1
2 Overview.....	2
3 Appearance	3
4 Application Scenarios	5
5 Software Operation Instruction	6
5.1 Detect the Sender and Receiver Card	6
5.2 Receiver Mapping Settings.....	7
5.2.1 Mapping Settings.....	8
5.2.2 Saving Mapping	8
5.2.3 Backup Port Settings	9
5.2.4 Reading Mapping.....	9
5.3 Video Source Settings.....	10
5.3.1 Multi-window Display	10
5.3.2 Window Settings.....	11
5.3.3 Picture Adjustment	11
5.3.4 Preset.....	12
5.3.5 Video Sync.....	13
5.3.6 Cropping.....	14
5.3.7 EDID (Resolution)	15
5.4 Network.....	16
5.5 3D(Optional)	16
5.6 Precise Color Management.....	17
5.7 Other	18

1.Safety Information

To prevent personal injury and to protect the device from damage, read and follow these safety precautions.

- **Do not remove the cover**
To avoid personal injury, do not remove the top cover.
- **Only use the power supply and accessories specified by the manufacturer**
The operating voltage of this product is 100V-240V AC. Only use the power cord provided with the product or the power cord that meets the appropriate local rating standards.
- **Prevent function interfaces from contact with charged objects**
This is an electric product. The circuit elements may be damaged if the function interfaces contact charged objects.
- **Grounding**
To avoid electrical shock, ensure that the product is grounded.
- **Electromagnetic Interference**
This is a class A product. In a domestic environment, this product may cause radio interference in which case the user may be required to take adequate measures
- **Environmental Condition**
Use only at altitudes not more than 5000m above sea level.
- **Avoid Moisture**
This product is not waterproof, so avoid contact with liquid or operating the product in a humid environment.
- **Keep the product away from flammable and explosive hazardous substances**

Unpacking and Inspection

After unpacking, checking the items according to the packing list in the box. Please contact the salesman in time if you find the accessories are incomplete.

2 Overview

X16E is a controller possessing powerful video signal input and processing capacity. It supports 4K inputs with DP 1.2 and HDMI 2.0 connectors, and 2K inputs with HDMI 1.4 and DVI connectors, and the multiple signals can be seamlessly switched. Equipped with 16 Gigabit Ethernet ports, X16E can greatly meet your different demands. Additionally, X16E boasts abundant practical functions that enable flexible screen control and high-quality image display.

Features

- Input connectors: 1×DP 1.2, 1×HDMI 2.0, 2×HDMI 1.4, 2×DVI
- Input resolution: up to 4096×2160@60Hz, supporting customized setting
- Output connectors: 16×Gigabit Ethernet port
- Support video source switching, cropping, splicing and scaling
- Support up to 6 windows, of which the location and size can be freely adjusted
- Support precise color management and display gamut adjustment
- Support video sync
- Separate audio input and output
- Support RS232 control
- Support LAN control
- Support HDCP
- Support brightness and color temperature adjustment
- Support better gray at low brightness

3 Appearance

Front Panel



No.	Item	Function
1	LCD	Display the operation menu and system information
2	Knob	Turn the knob to select an item or adjust the parameter; press the knob to confirm your selection or adjustment
3	Function Keys	OK: Enter key Bright: Brightness adjustment ESC: Exit the current menu or operation Black: Blackout Lock: Lock all the keys of the front panel Freeze: Freeze the image
4	Mode Keys	HDMI1/DP/3/HDMI2/HDMI3/DVI1/DVI2: Video source selection keys, which function as number selection keys in mode selection Signal: View the signals Mode: Output mode selection
5	Power Switch	Switch the device on or off

Back Panel



Input Connector		
1	HDMI 2.0	1×HDMI 2.0
2	DP 1.2	1×DP 1.2
3	HDMI1, HDMI2	2×HDMI 1.4
4	DVI1, DVI2	2×DVI
Output Connector		
1	Port 1-16	RJ45, 16×Gigabit Ethernet port
Control Connector		
1	LAN	Network control (communication with PC, or access network)
2	RS232	RJ11(6P6C)*, connect to the third party device
3	USB OUT	USB output, for cascading with the controller
4	USB IN	USB input, connecting to PC for debugging
5	3D sync(optional)	Connect to the 3D emitter
Audio Connector		
1	AUDIO IN	Audio input, for inputting audio signals from the computer or other devices
2	AUDIO OUT	Audio output, for outputting audio signals to the speaker (Support outputting the audio signals of HDMI and DP)
Power Connector		
1	AC 100~240V	AC power connector, containing a built-in fuse

*DB9 female to RJ11(6P6C) cable:

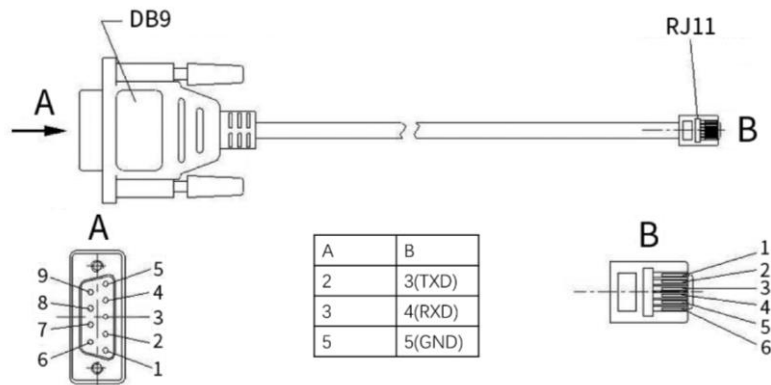

4 Application Scenarios

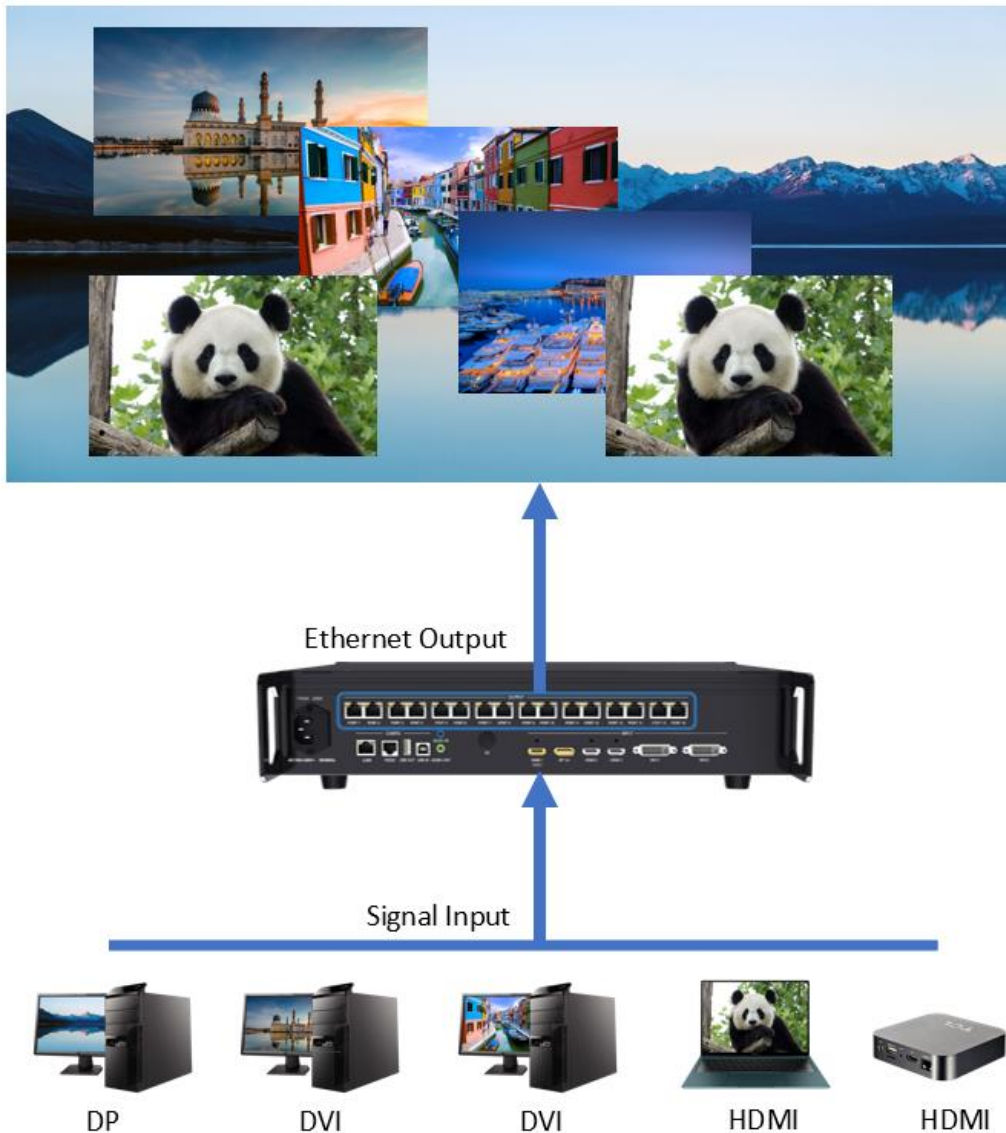

5 Software Operation Instruction

Please make sure the hardware is properly connected before setting parameters, and that all senders and receiver cards can be detected by the software. You can visit www.colorlightinside.com to download LEDVISION installer.

5.1 Detect the Sender and Receiver Card

Open LEDVISION, click **Control**, select **LED Screen Settings** from the drop-down list, and enter the password “168” .

In the pop-up **LED Screen Settings** window, click **Detect Senders** in the upper-right corner of the window, and the number, model and version of the sender are displayed in the field next to **Detect Senders**. When the input of signals is normal, the current status of signals can be displayed in the **Signal Selection** area.

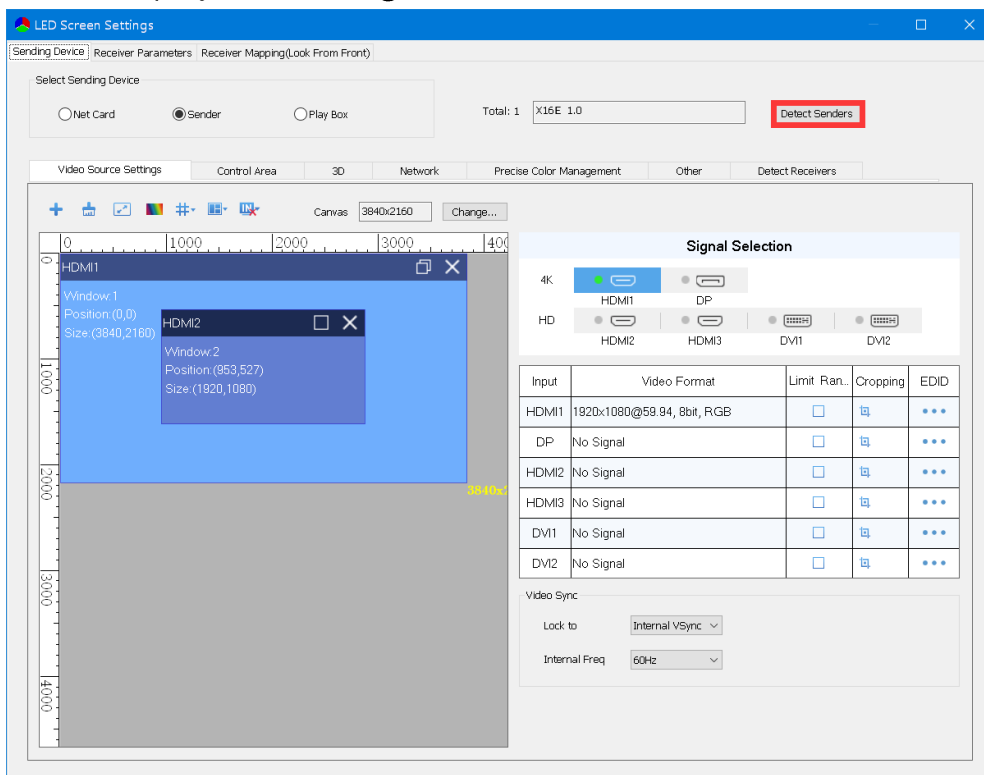

Click **Detect Receivers**. On the **Detect Receivers** subpage, click **Detect All Receivers**, and the software will automatically acquire information such as the port, index, version, running time, and supported chips of the receiver card. Please check the corresponding cable if the number of receiver cards are inconsistent with actual status.

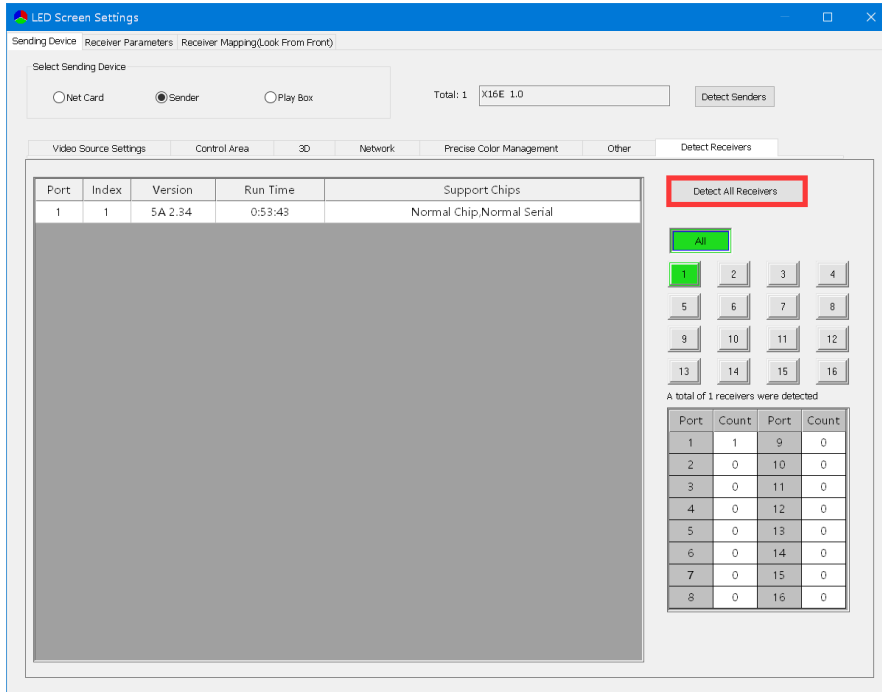

5.2 Receiver Mapping Settings

Click **Receiver Mapping** to enter the receiver mapping setting page.

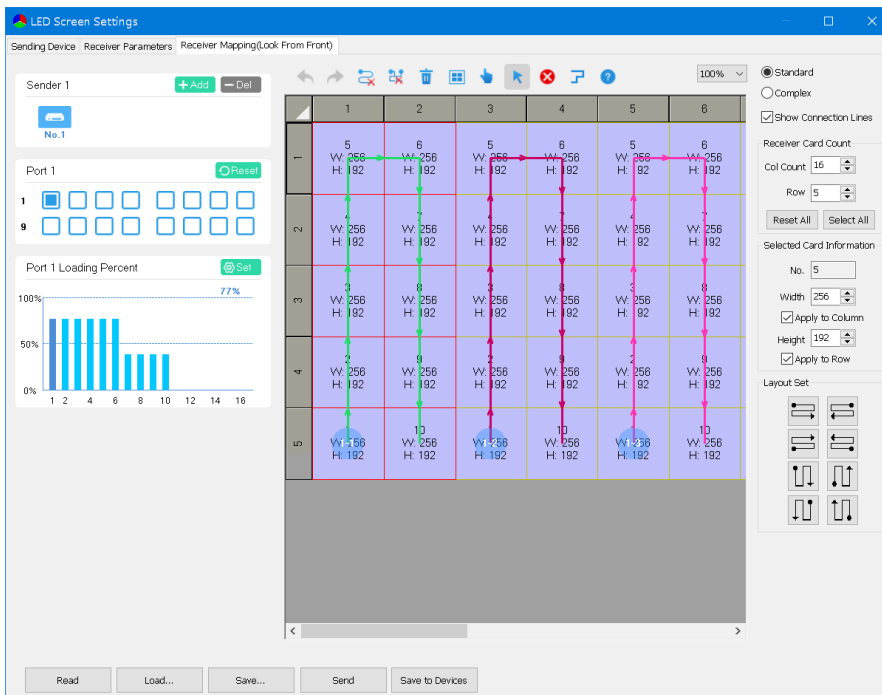

Detailed setting steps are as follows:

5.2.1 Mapping Settings

Select the target Ethernet port on the left side, and then select the corresponding cabinets within the actual control area of the port and set the connection lines in the simulated cabinet area.

In the simulated cabinet area, select the corresponding cabinet of the first receiver card based on the actual connection of the Ethernet port (view from the front), and left-click the cabinet one by one according to actual connecting line, until the last one this Ethernet port controls.

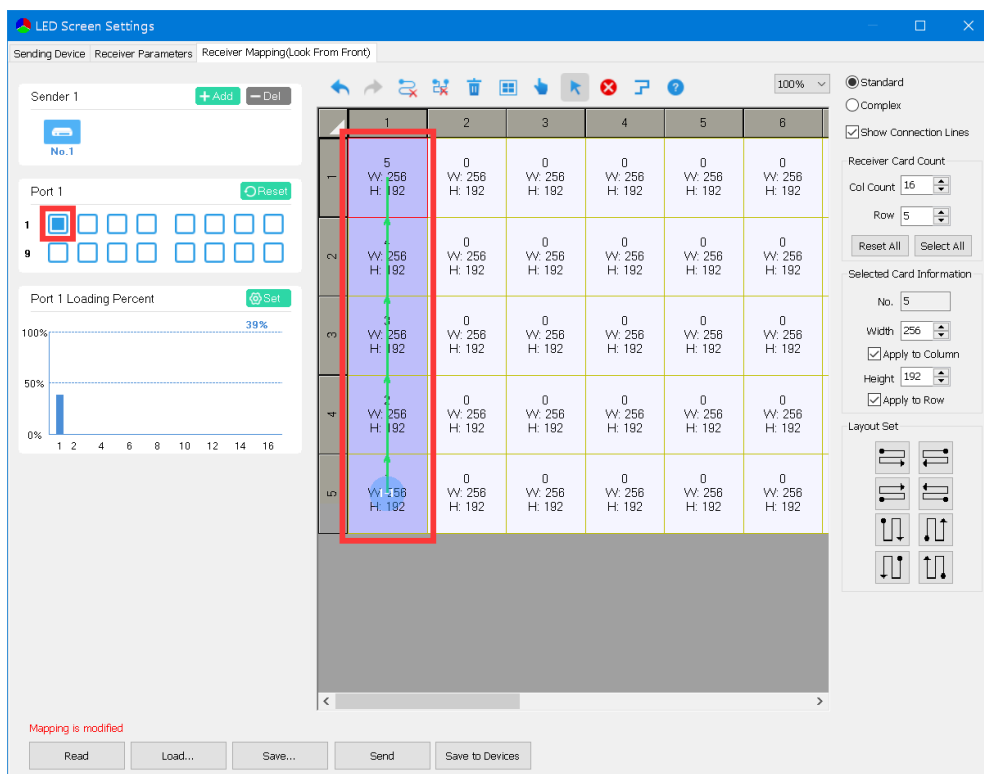

For the cabinets with different specifications (different in dimensions), you can select them and adjust the mapping separately after setting.

5.2.2 Saving Mapping

After successively setting the cabinets each port controls and their mapping, click **Send** and **Save to Devices** at the bottom of the window to send and save the mapping to the current sender and receiver cards.

5.2.3 Backup Port Settings

Right-click the sequence number of the backup port, and select the target port that needs a backup. After setting, a backup sign will be displayed besides the sequence number of the backup port.

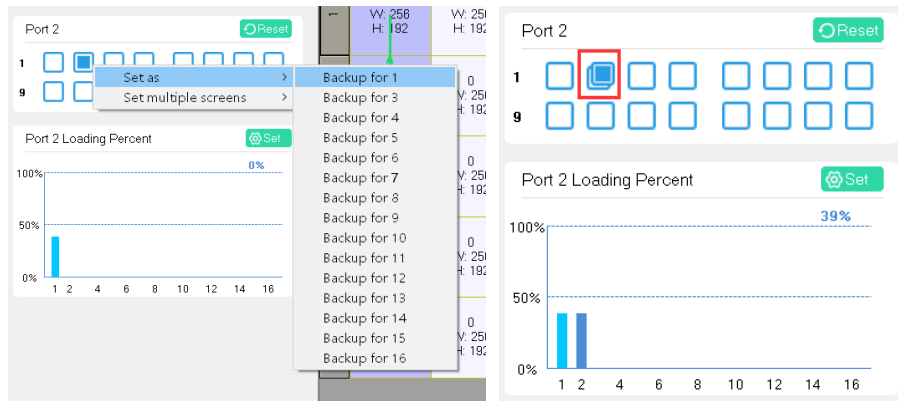

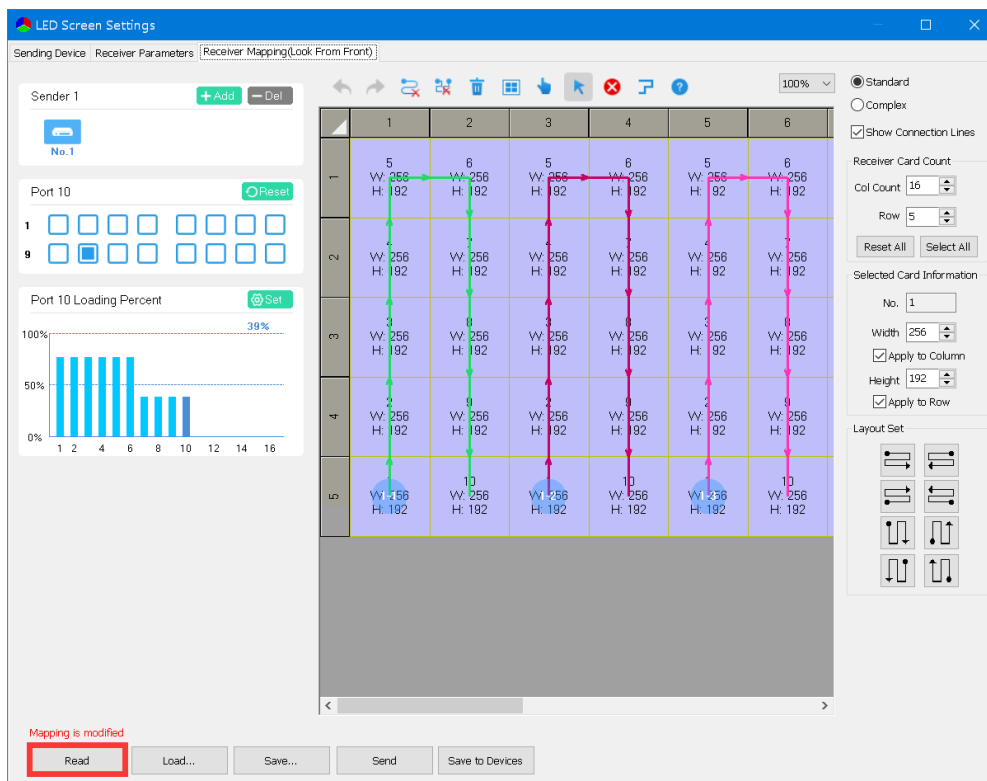

5.2.4 Reading Mapping

Click Read in the lower-left corner of the page, and the mapping parameters of cabinets saved in the receiver cards can be read back.



5.3 Video Source Settings

5.3.1 Multi-window Display

The device supports up to 6-window display. You can click  to add a window, and then select the added window and switch signals in the **Signal Selection** area; or click  to delete all windows.

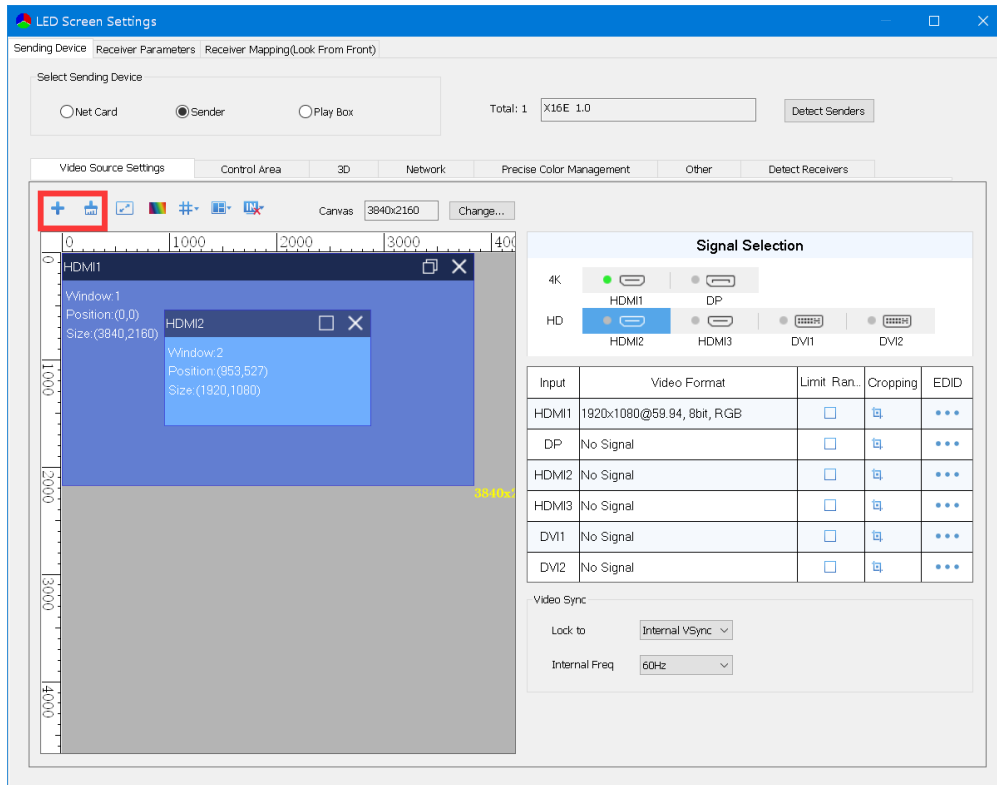

5.3.2 Window Settings

You can right-click the window or click  to set the position and size of the selected window.

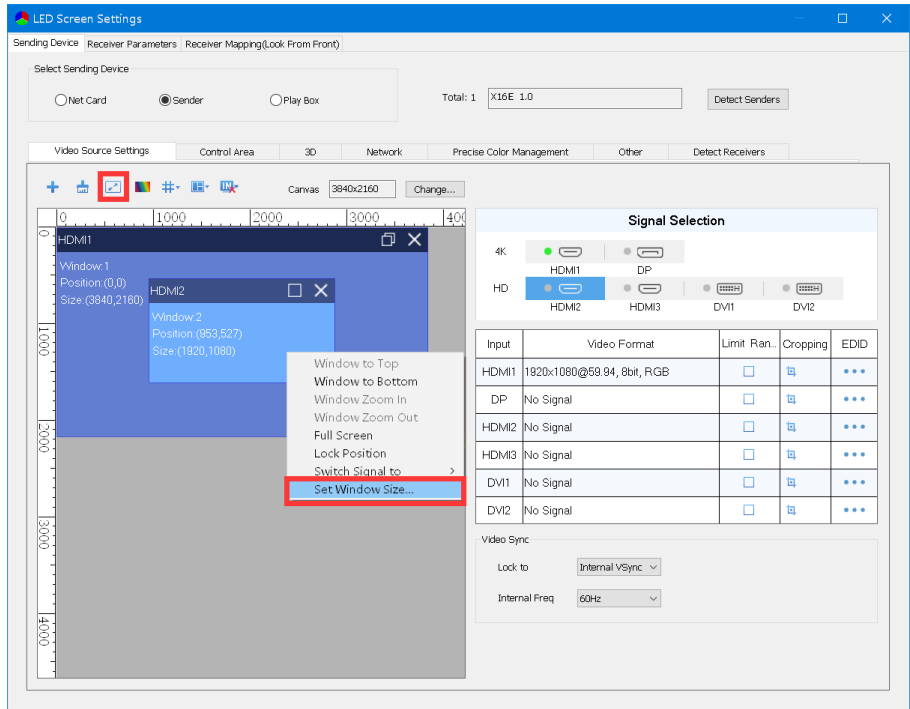

5.3.3 Picture Adjustment

Click , and select the Enable check box, and then you can adjust the hue, saturation, brightness compensation and contrast values of the image.

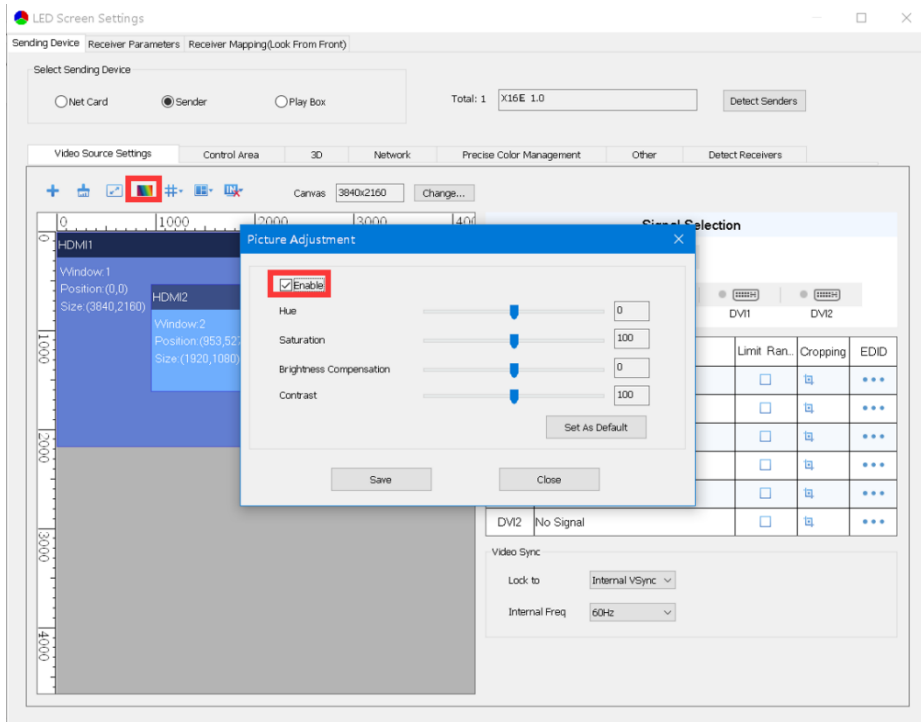

5.3.4 Preset

You can save 16 preset modes, and every preset mode includes the following parameter information of the video source setting: scaling, cropping, multi-window display, picture adjustment, color space, brightness and color temperature. You can also directly load the saved preset mode to display the image according to your need without needing to set up all the parameters again.

After setting the video source parameters, click **Save Preset**, select an unnamed preset item and rename it, and then click **OK** to save the preset to the sender.

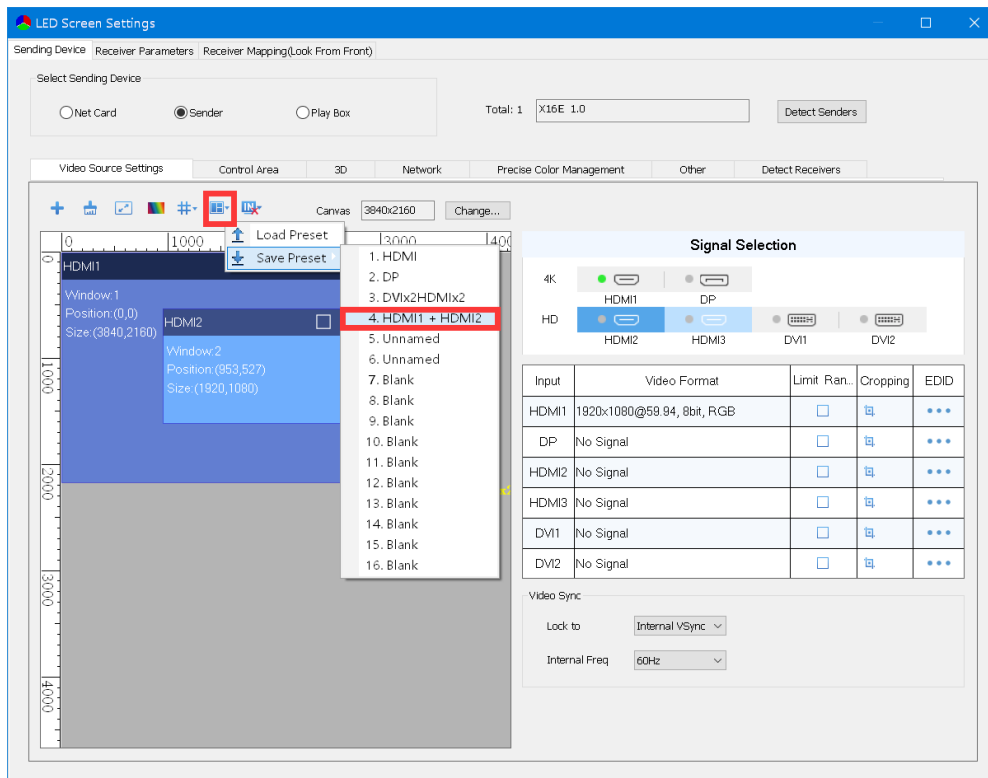

Click Load Preset, select a preset item, and the screen will display image on the basis of the preset parameter.

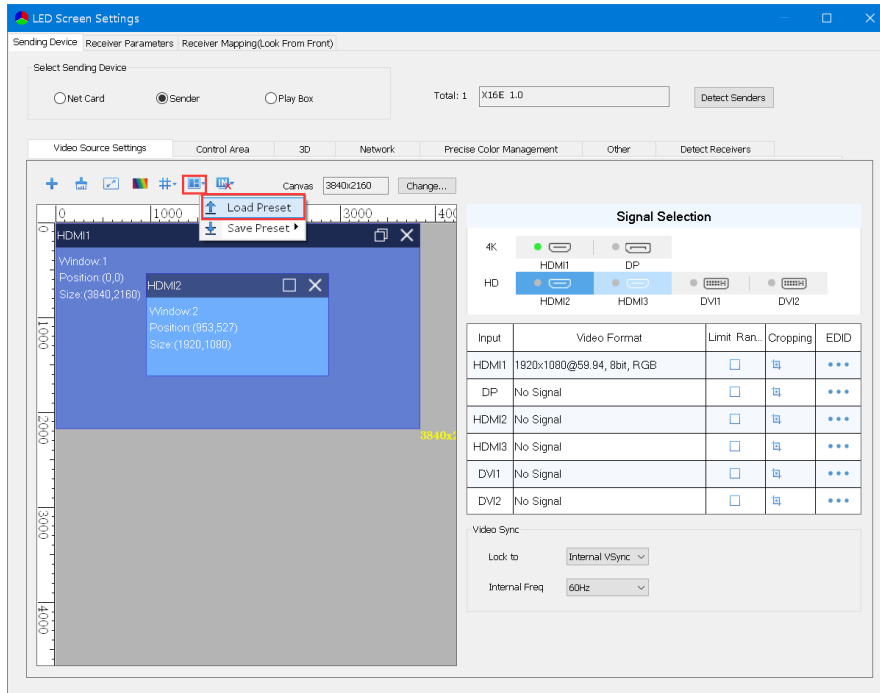

5.3.5 Video Sync

The synchronous signal source can be any channel of input signals or **Internal-Vsync**. If the specified synchronous signal source has no signal, the main image will serve as the source.

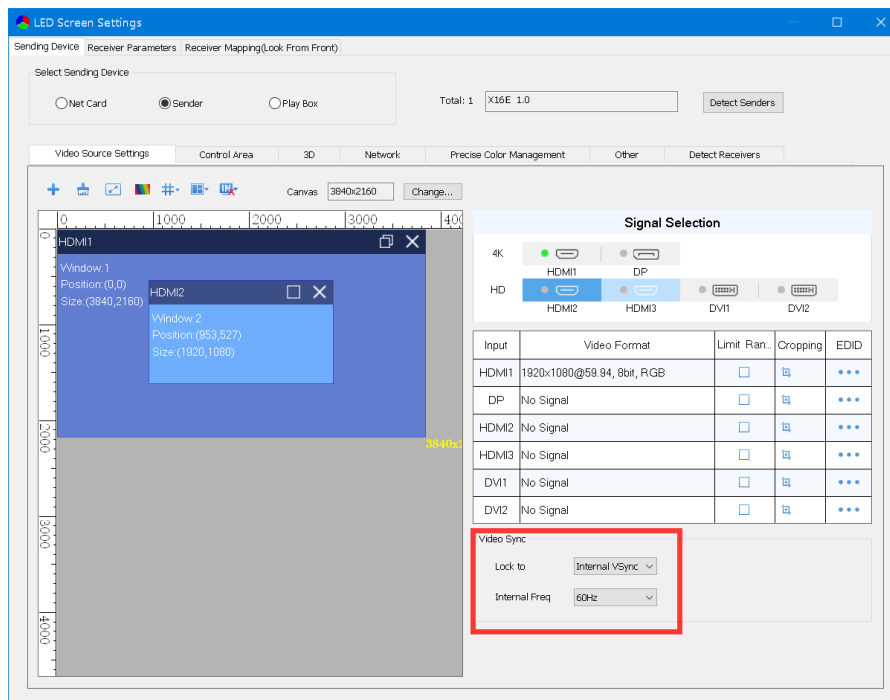

5.3.6 Cropping

At the right side of the **Video Source Settings** subpage, click  to enter the cropping setting window.

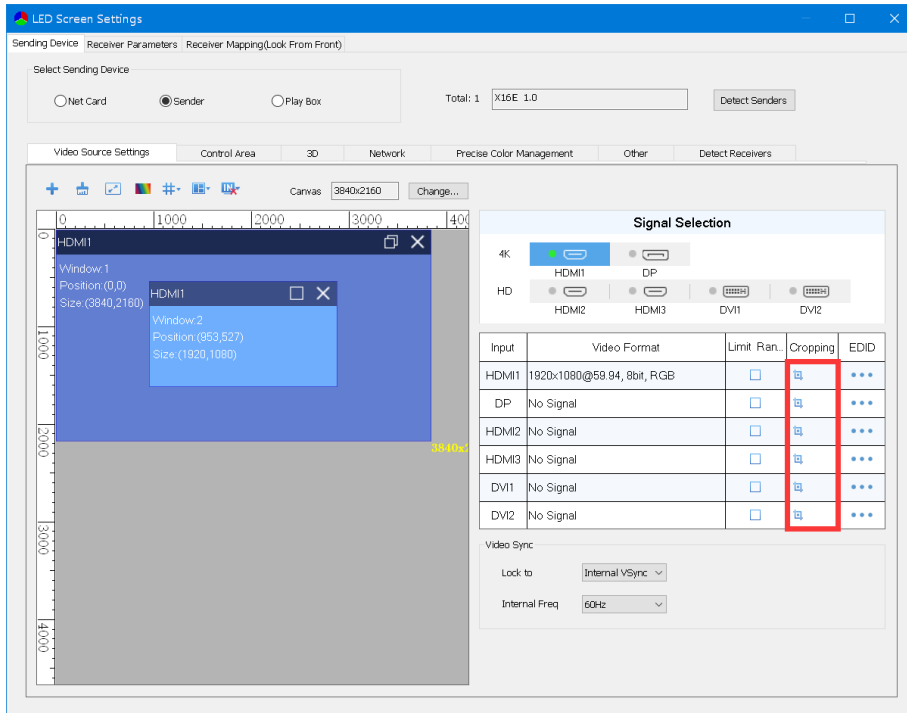

In the cropping setting window, select the **Enable** check box, and set the row starting point (X), the column starting point (Y), and the width and height in the **Cropping Settings** area.

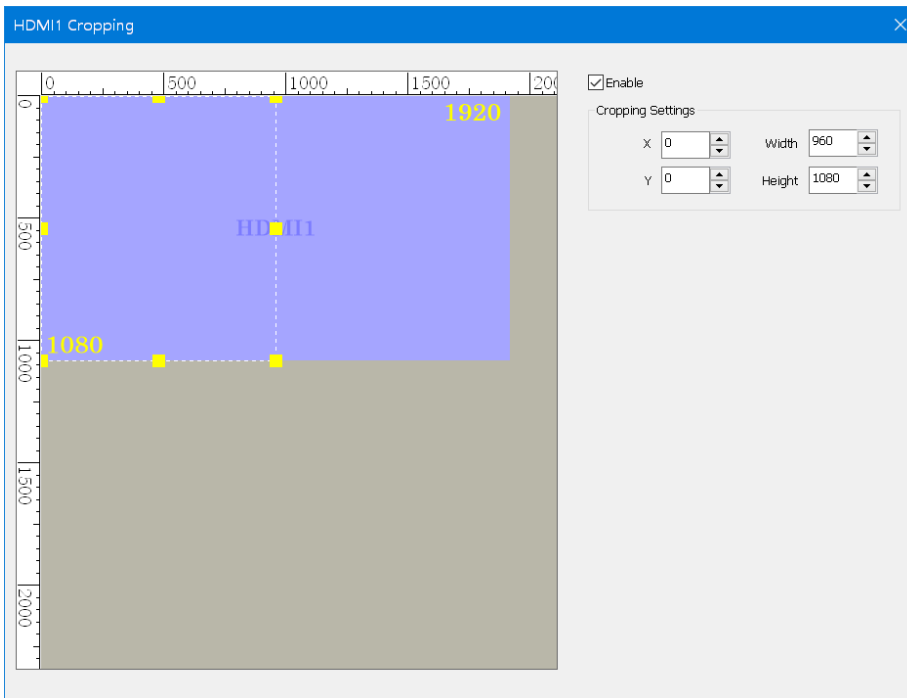

5.3.7 EDID (Resolution)

In the lower-right corner of the **Video Source Settings** subpage, click **...**.

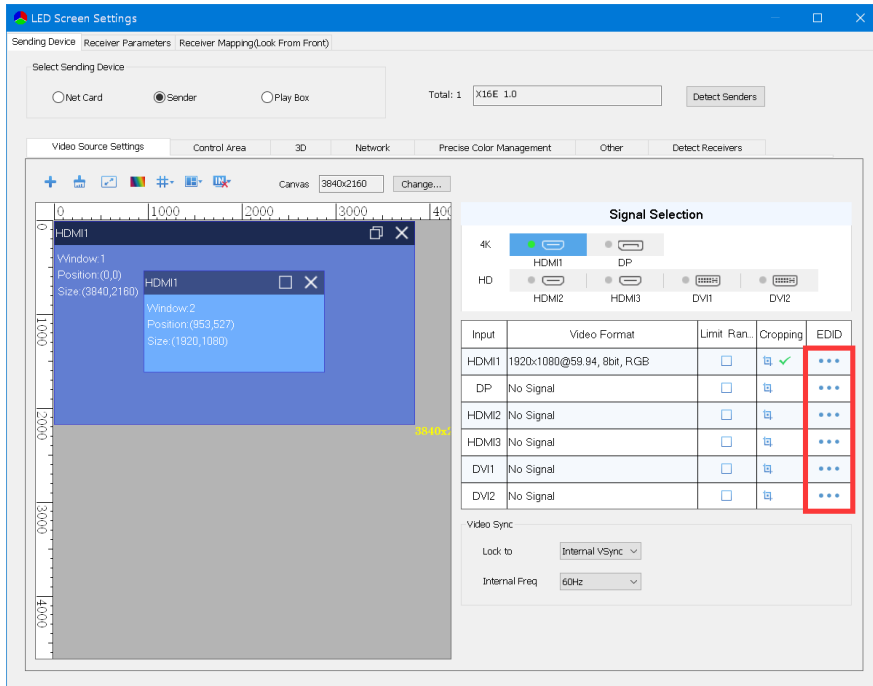

In the **Resolution (EDID) Setting** dialog box, the resolution of the current sender is displayed by default.

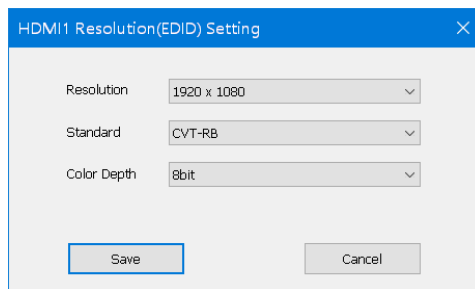

Click the dropdown button. From the resolution list, you can select a conventional resolution, or select **Custom** and set the width, height, frame rate and standard of the customized resolution.

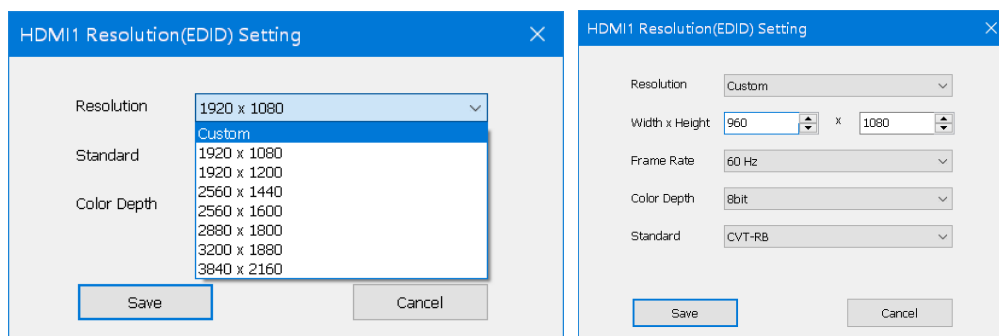

After setting, click **Save**.

5.4 Network

Click **Network**. On the **Network** sub-page, click **Obtain an IP Address Automatically**, and the device will automatically obtain the IP address. Or you can click **Use the Following IP Address**, and then manually enter the IP address, subnet mask and default gateway. After setting, click **Save**.

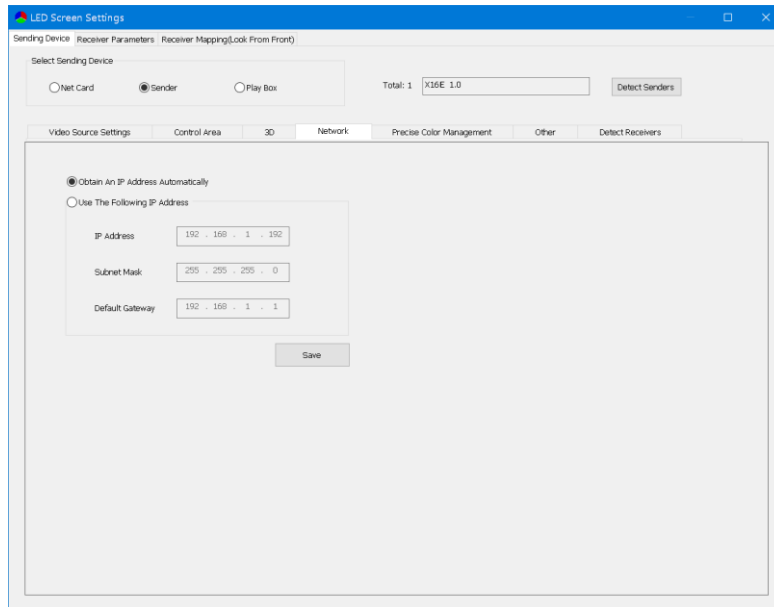

5.5 3D(Optional)

It is used in conjunction with a 3D emitter and 3D glasses. You can set the **Input Selection** according to the video signal and window, and then adjust the **Signal Delay Time** parameter to achieve good display effect.

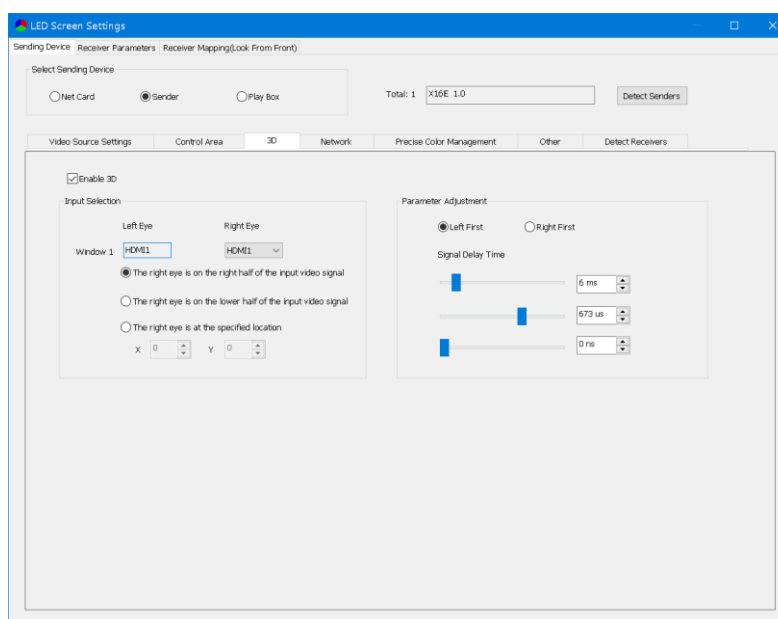

5.6 Precise Color Management

Select the **Enable Precise Color Management** check box in the upper-left corner of the **Precise Color Management** subpage, and you can modify the parameters of LED color and brightness, and color space.

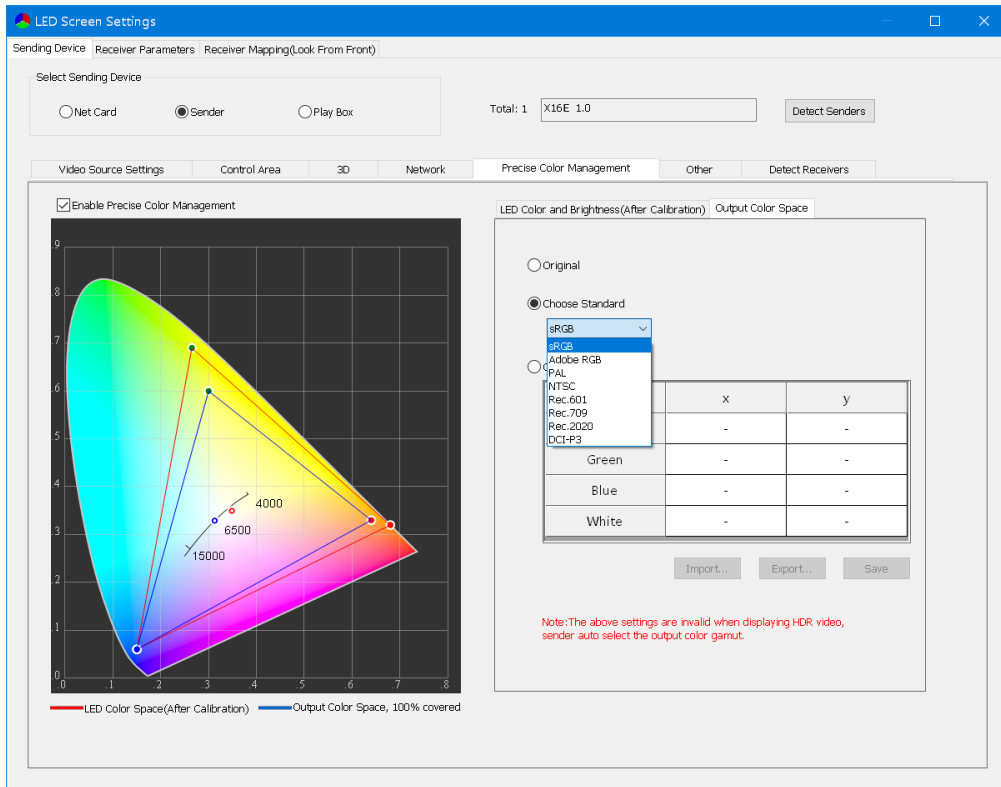

5.7 Other

On the Other subpage, you can set **Better Gray On Low Brightness**, **Mapping from Sender**, **Vsync**, and **Input Audio**, adjust volume, rename the sender, modify the sender name, and select a test mode.

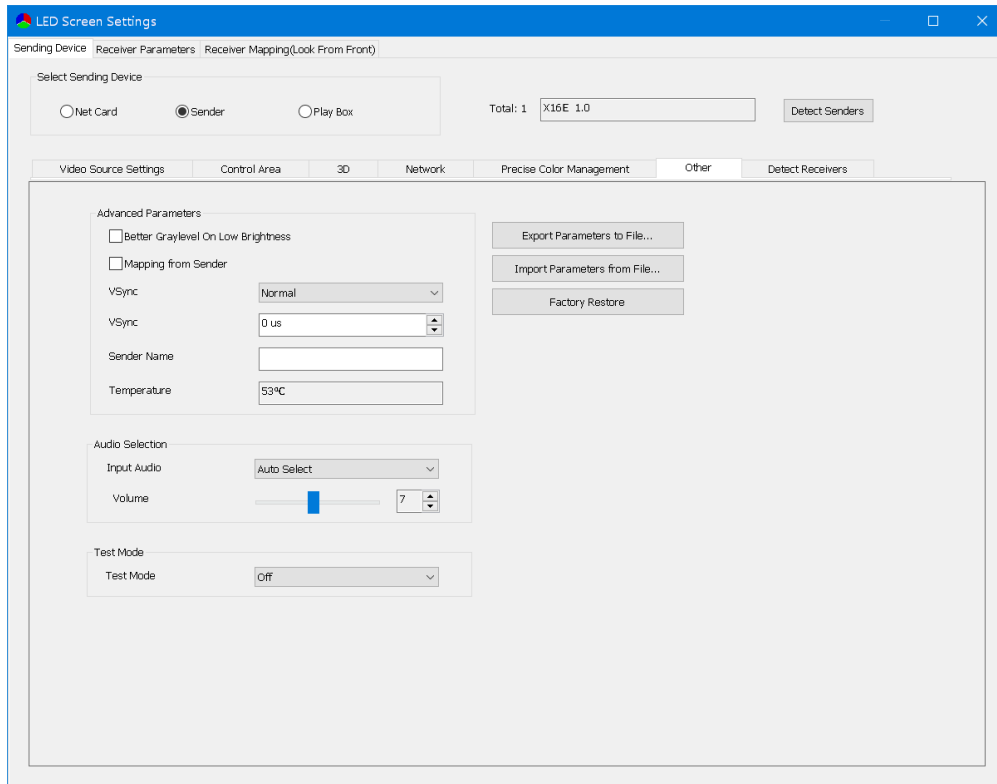



Visual Future

Colorlight Cloud Tech Ltd
www.colorlightinside.com