

---

# Q16pro

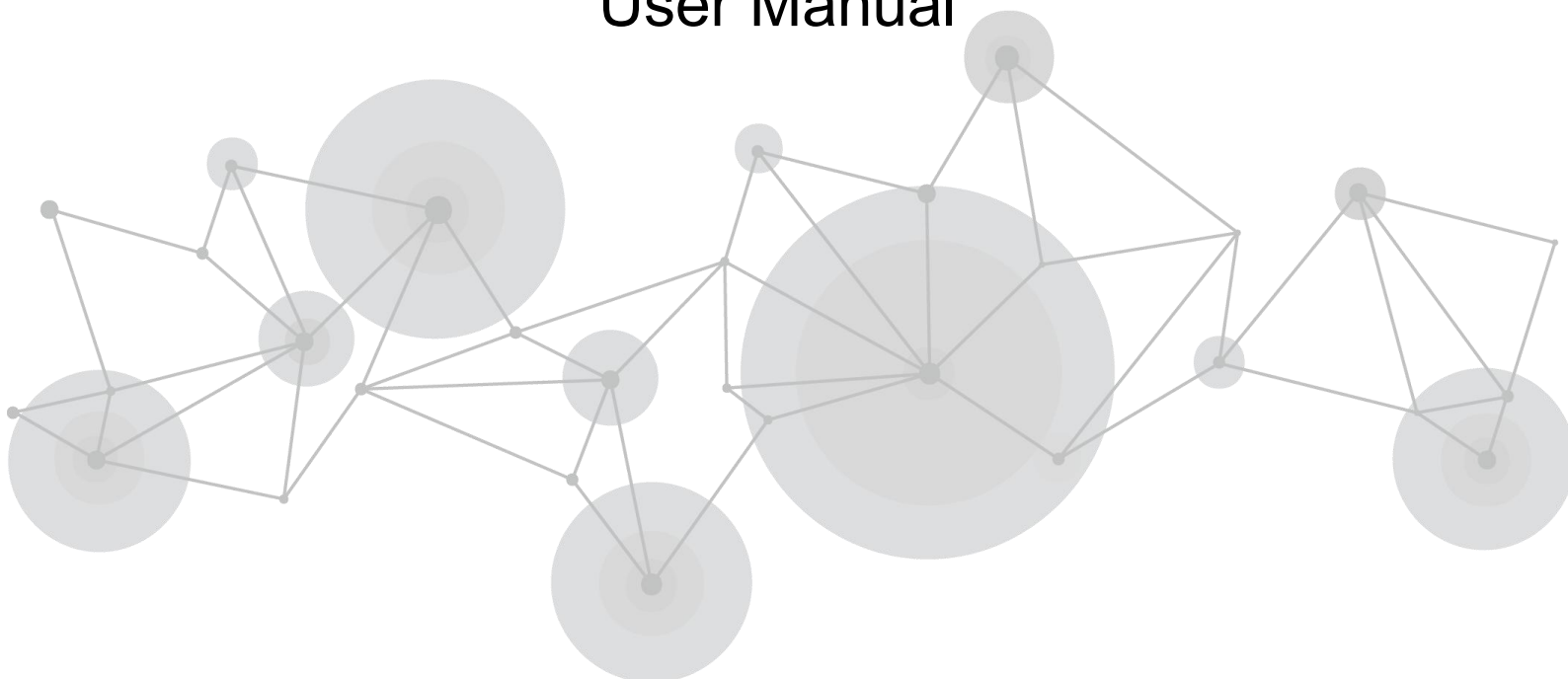

## **RGBlink<sup>®</sup>** User Manual



---

## Content

Content .....	2
Declarations .....	3
FCC/Warranty .....	3
Operators Safety Summary .....	4
Installation Safety Summary .....	4
Chapter 1 Your Product .....	6
1.1 In the Box .....	6
1.2 Product Overview .....	7
1.2.1 Key Features .....	7
1.2.2 Front Panel .....	8
1.2.3 Rear Panel .....	9
1.2.4 Dimension .....	13
Chapter 2 Install Your Product .....	16
2.1 Plug in Power .....	16
2.2 Connect Input Signal Source .....	16
2.3 Connect Output Source .....	17
Chapter 3 Use Your Product .....	19
3.1 XPOSE 2.0 Installation .....	19
3.2 XPOSE Operation .....	22
3.2.1 Login in XPOSE .....	22
3.2.2 System Setting .....	24
3.2.3 Output   Input   Overview .....	28
3.2.4 Display Management .....	34
3.2.5 Layer Management .....	36
3.2.6 Preset Management .....	43
3.3 XPOSE APP Control .....	45
Chapter 4 Order Code .....	46
4.1 Product Code .....	46
4.2 Module Code .....	46
Chapter 5 Support .....	47
5.1 Contact us .....	47
Chapter 6 Appendix .....	48
6.1 Specification .....	48
6.2 Terms & Definitions .....	51
6.3 Revision History .....	57

---

**Thank you for choosing our product!**

**This User Manual is designed to show you how to use this video processor quickly and make use of all the features. Please read all directions and instructions carefully before using this product.**

## *Declarations*

### *FCC/Warranty*

#### **Federal Communications Commission (FCC) Statement**

This equipment has been tested and found to comply with the limits for a class A digital device, pursuant to Part 15 of the FCC rules. These limits are designed to provide reasonable protection against harmful interference when the equipment is operated in a commercial environment. This equipment generates, uses, and can radiate radio frequency energy and, if not installed and used in accordance with the instruction manual, may cause harmful interference to radio communications. Operation of this equipment in a residential area may cause harmful interference, in which case the user will be responsible for correcting any interference.

#### **Guarantee and Compensation**

RGBlink provides a guarantee relating to perfect manufacturing as part of the legally stipulated terms of guarantee. On receipt, the purchaser must immediately inspect all delivered goods for damage incurred during transport, as well as for material and manufacturing faults. RGBlink must be informed immediately in writing of any complains.

The period of guarantee begins on the date of transfer of risks, in the case of special systems and software on the date of commissioning, at latest 30 days after the transfer of risks. In the event of justified notice of compliant, RGBlink can repair the fault or provide a replacement at its own discretion within an appropriate period. If this measure proves to be impossible or unsuccessful, the purchaser can demand a reduction in the purchase price or cancellation of the contract. All other claims, in particular those relating to compensation for direct or indirect damage, and also damage attributed to the operation of software as well as to other service provided by RGBlink, being a component of the system or independent service, will be deemed invalid provided the damage is not proven to be attributed to the absence of properties guaranteed in writing or due to the intent or gross negligence or part of RGBlink.

If the purchaser or a third party carries out modifications or repairs on goods delivered by RGBlink, or if the goods are handled incorrectly, in particular if the systems are commissioned operated incorrectly or if, after the transfer of risks, the goods are subject to influences not agreed upon in the contract, all guarantee claims of the purchaser will be rendered invalid. Not included in the guarantee coverage are system failures which are attributed to programs or special electronic circuitry provided by the purchaser, e.g. interfaces. Normal wear as well as normal maintenance are not subject to the guarantee provided by RGBlink either.

The environmental conditions as well as the servicing and maintenance regulations specified in this manual must be complied with by the customer.

---

## Operators Safety Summary

The general safety information in this summary is for operating personnel.

### **Do Not Remove Covers or Panels**

There are no user-serviceable parts within the unit. Removal of the top cover will expose dangerous voltages. To avoid personal injury, do not remove the top cover. Do not operate the unit without the cover installed.

### **Power Source**

This product is intended to operate from a power source that will not apply more than 230 volts rms between the supply conductors or between both supply conductor and ground. A protective ground connection by way of grounding conductor in the power cord is essential for safe operation.

### **Grounding the Product**

This product is grounded through the grounding conductor of the power cord. To avoid electrical shock, plug the power cord into a properly wired receptacle before connecting to the product input or output terminals. A protective-ground connection by way of the grounding conductor in the power cord is essential for safe operation.

### **Use the Proper Power Cord**

Use only the power cord and connector specified for your product. Use only a power cord that is in good condition. Refer cord and connector changes to qualified service personnel.

### **Use the Proper Fuse**

To avoid fire hazard, use only the fuse having identical type, voltage rating, and current rating characteristics. Refer fuse replacement to qualified service personnel.

### **Do Not Operate in Explosive Atmospheres**

To avoid explosion, do not operate this product in an explosive atmosphere.

## Installation Safety Summary

### **Safety Precautions**

For all product installation procedures, please observe the following important safety and handling rules to avoid damage to yourself and the equipment.

To protect users from electric shock, ensure that the chassis connects to earth via the ground wire provided in the AC power Cord.

The AC Socket-outlet should be installed near the equipment and be easily accessible.

---

## Unpacking and Inspection

Before opening product shipping box, inspect it for damage. If you find any damage, notify the shipping carrier immediately for all claims adjustments. As you open the box, compare its contents against the packing slip. If you find any shortages, contact your sales representative.

Once you have removed all the components from their packaging and checked that all the listed components are present, visually inspect the system to ensure there was no damage during shipping. If there is damage, notify the shipping carrier immediately for all claims adjustments.

## Site Preparation

The environment in which you install your product should be clean, properly lit, free from static, and have adequate power, ventilation, and space for all components.

---

# Chapter 1 Your Product

---

## 1.1 In the Box

**AC Power Cord**



**DVI Cable**



**HDMI-DVI Cable**



**Network Cable**



**Anti-Static Bag**



**Note:** AC Power Cable supplied as standard according to destination market.

## 1.2 Product Overview

Q16pro adopts modular design, supporting 8 layers on each output module. Each layer supports for scaling, moving, crossing and overlying. Besides, It supports custom output resolutions. It also supports RGBlink XPOSE 2.0 software operation.

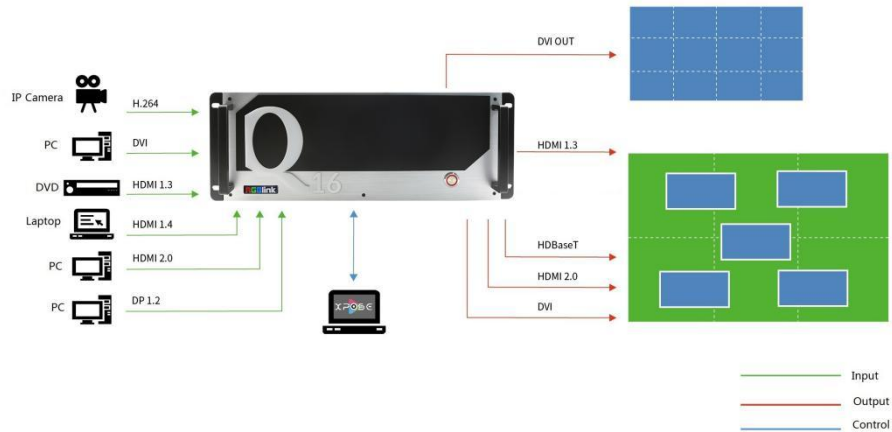

Q16pro SYSTEM CONNECTION DIAGRAM

### 1.2.1 Key Features

- Each module supports up to 8 layers
- Each layer support for scaling, moving, crossing and overlying
- Support 4K@60 inputs and outputs
- Each module supports for customized output resolution, single port's width up to 3840 and height up to 3840
- Optional independent audio input&output modules
- XPOSE visualization operation
- EDID management

## 1.2.2 Front Panel

Q16pro-4

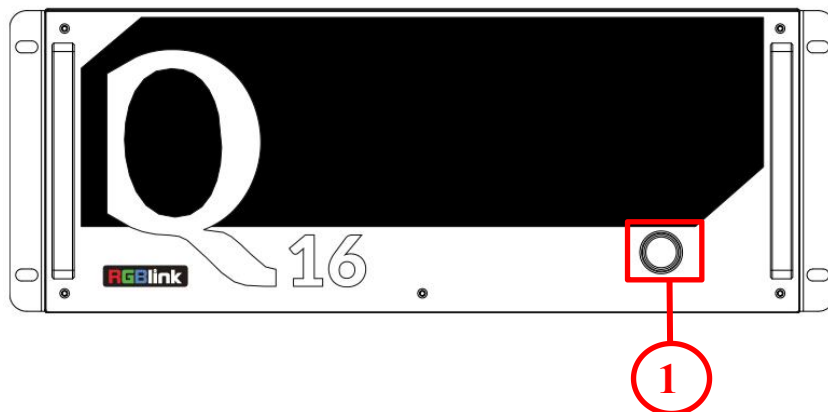

Q16pro-8

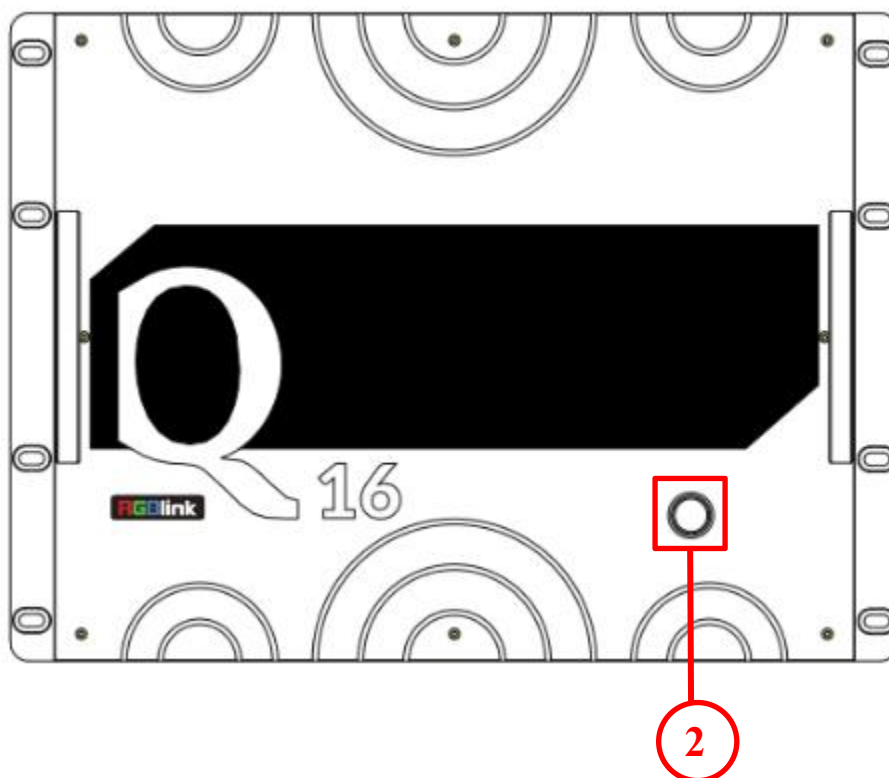



## Q16pro-14

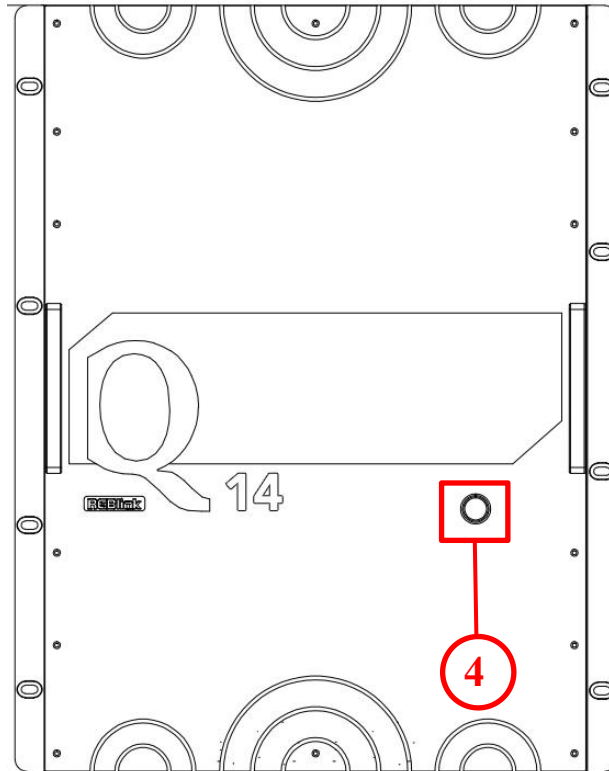



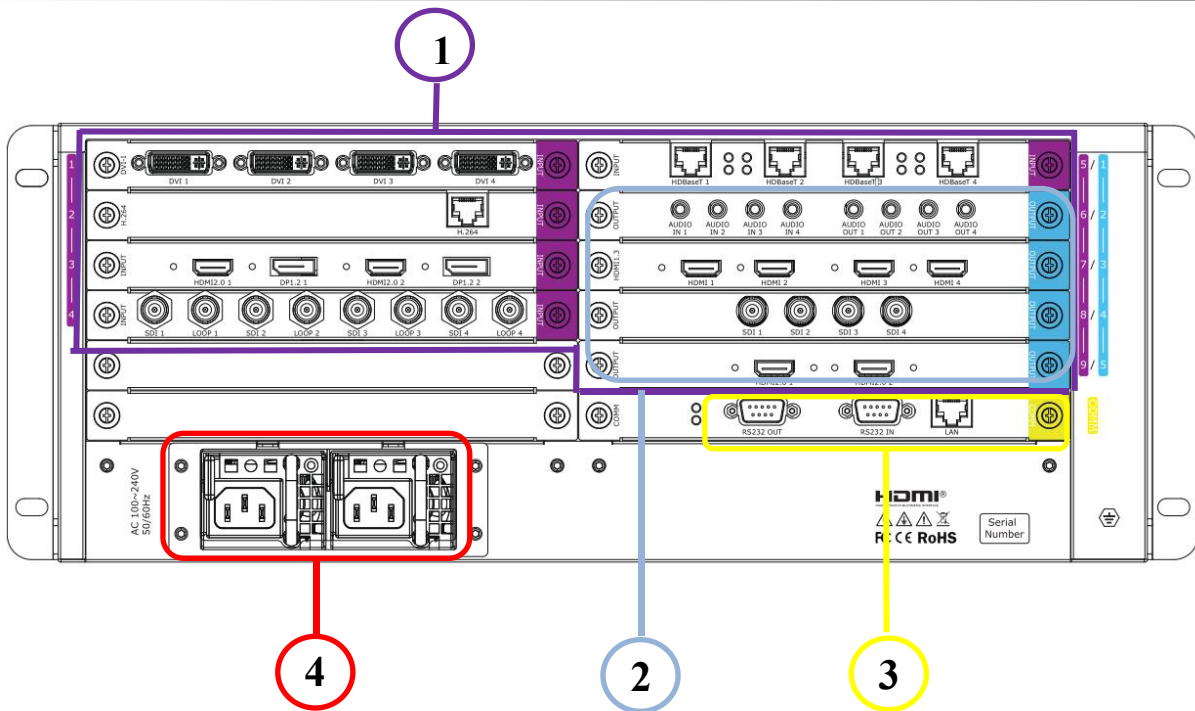

1/2/3/4		Power Switch
---------	--	--------------

### 1.2.3 Rear Panel

## Q16pro-4



1	Purple Input 1-4	Input slots 1-4,supporting DVI,HDMI,DP,H.264 modules and other optional modules.
2	Blue Output 1-5	Output slots 1-5,supporting HDMI,DVI and other optional modules.
3	Yellow COMM	Communication board with LAN and RS232 port,to connect router or computer to realize software control.
4		Power Interface,4U and above supports double power supply.

**Note:**  purple tip indicates input,  blue tip indicates output,  yellow tip indicates communication.

# Q16pro-8

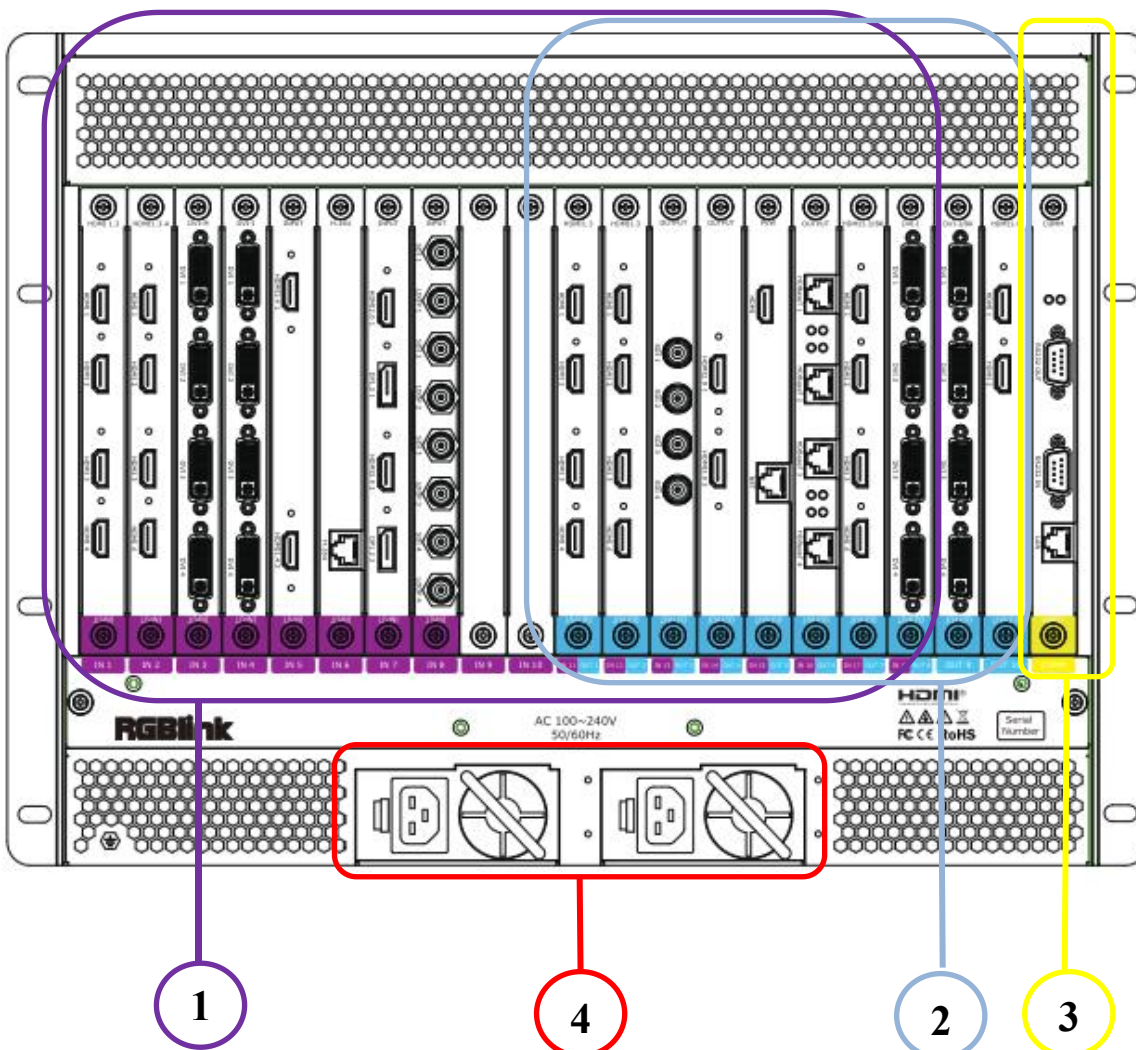

1	Purple Input 1-10	Input slots 1-10, supporting DVI, HDMI, DP, H.264 modules and other optional modules.
2	Blue Output 1-20	Output slots 1-18, supporting HDMI, DVI and other optional output modules, supporting input modules. Slot 19-20 can only be used for output.
3	Yellow COMM	Communication board with LAN and RS232 port, to connect router or computer to realize software control.
4		Power Interface, 4U and above supports double power.

Q16pro-14

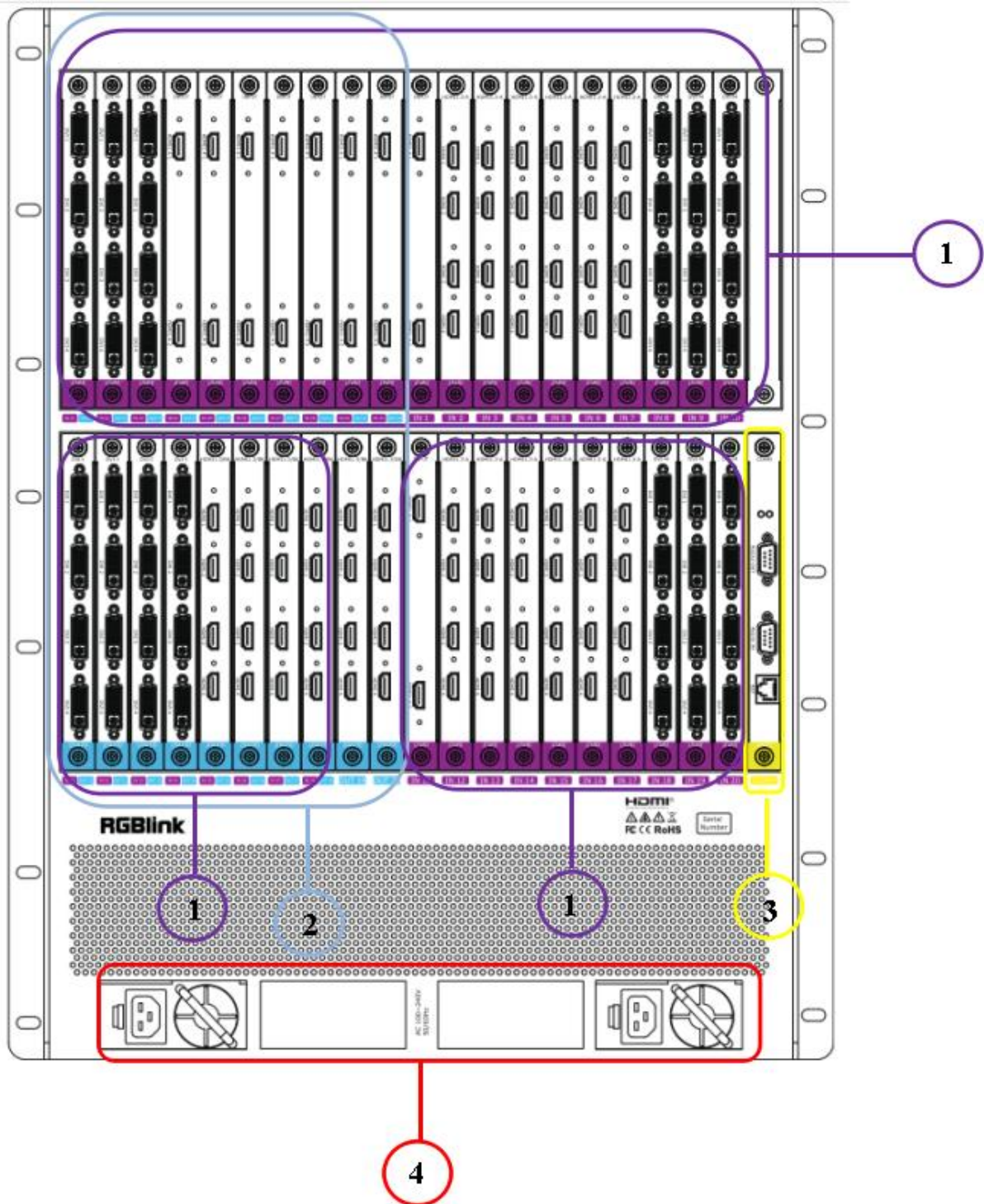

1	Purple Input 1-20	Input slots 1-20, supporting DVI,HDMI, DP,H.264 modules and other optional modules.
2	Blue Output 1-20	Output slots 1-18, supporting HDMI, DVI and other optional output modules, supporting input modules. Slot 19-20 can only be used for output.
3	Yellow COMM	Communication board with LAN and RS232 port, to connect router or computer to realize software control.
4		Power Interface, 4U and above supports double power supply.

## 1.2.4 Dimension

### Q16pro-4

Following is the dimension of Q16pro-4 for your reference:

484mm × 373mm × 178mm

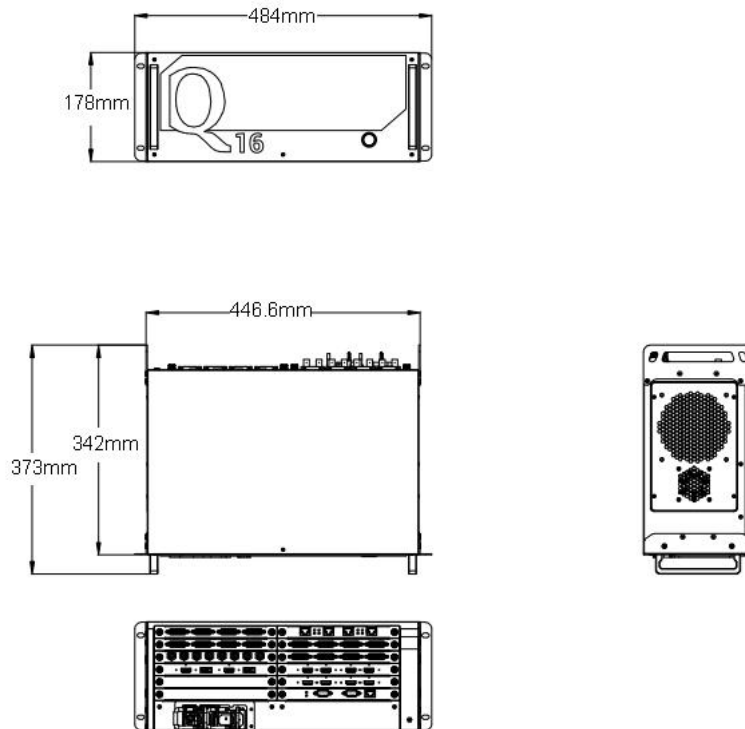

## Q16pro-8

Following is the dimension of Q16pro-8 for your reference:

488mm×370mm×355.6mm

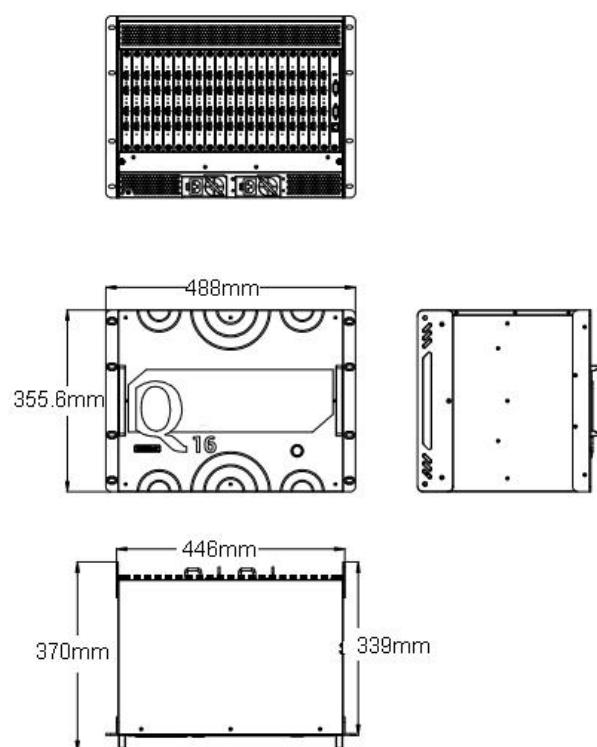

## Q16pro-14

Following is the dimension of Q16pro-14 for your reference:

485mm×310mm×560mm

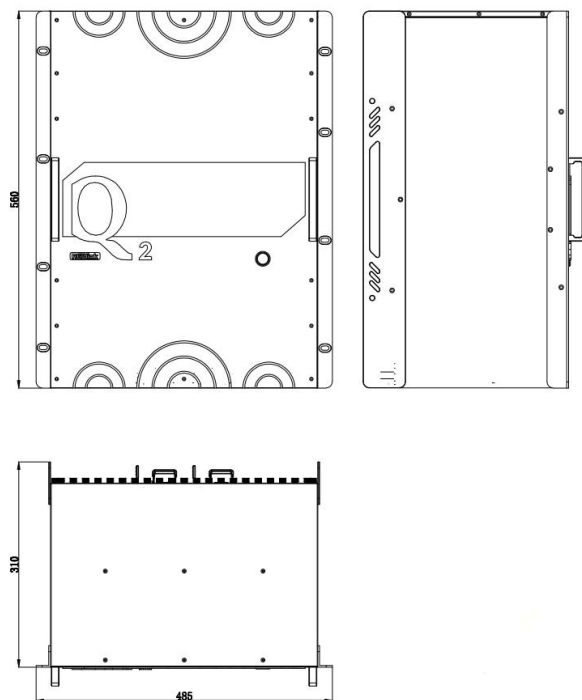



---

## Chapter 2 Install Your Product

---

### 2.1 Plug in Power

Take Q16pro-4 as example

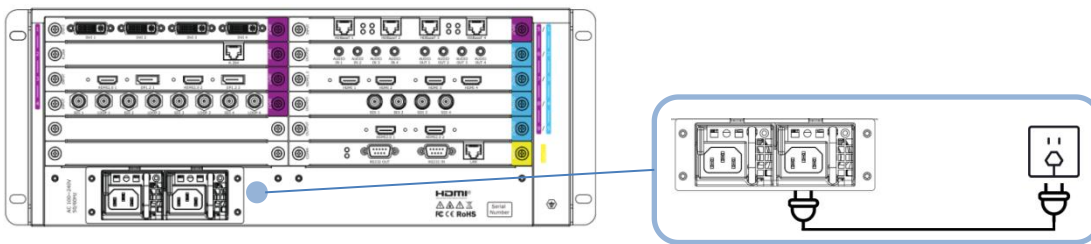

Connect power and Q16pro-4 with standard AC Power Cord.

### 2.2 Connect Input Signal Source

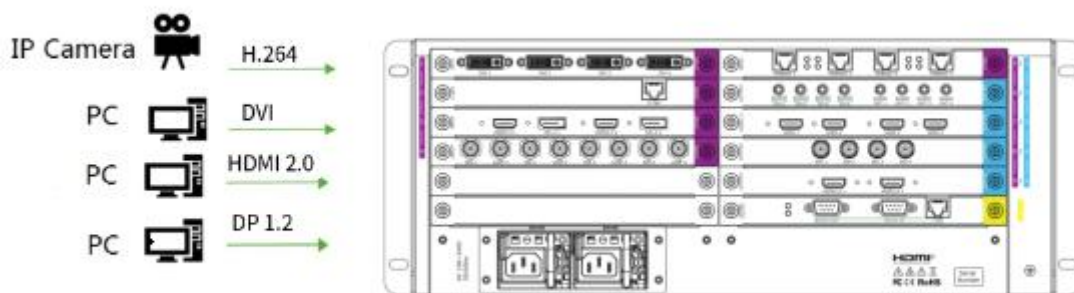

Q16pro series supports HDMI、DVI、SDI、DP1.2、HDBaseT and other optional input modules.  
Connect Q16pro-4 with IP Camera,PC,DVD,laptop and other device as shown in the figure above.



## 2.3 Connect Output Source

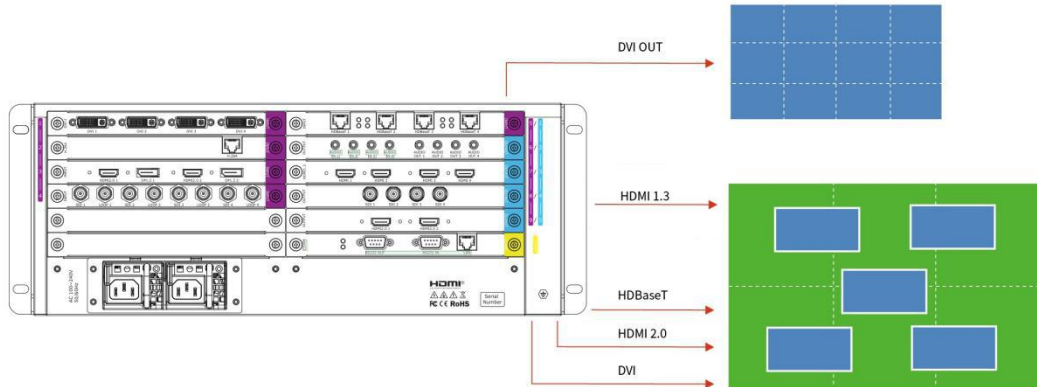

Q16pro Series supports SDI、 DVI、 HDMI、 HDBaseT and other optional output modules.  
Connect Q16pro-4 with monitors.

## 2.4 Connect control Computer

Q16pro series is operated by XPOSE,so it is necessary to connect device with control computer.

**Method 1: Direct Connection:**Connect Q16pro-4 with computer via network cable as shown in the figure below.It is suitable for single user to control the device.

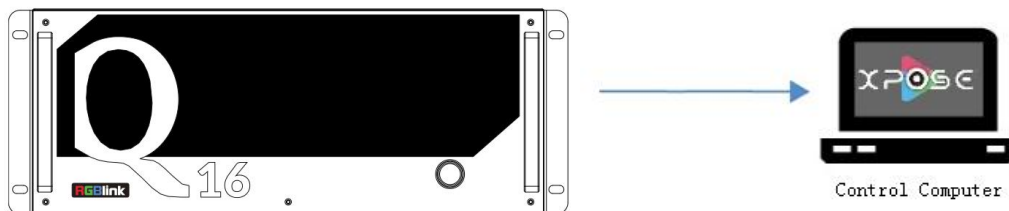

**Method 2: Router Connection:**Connect control computer and Q16pro-4 with Router as shown in the figure below.It supports simultaneous online operation by multiple users.

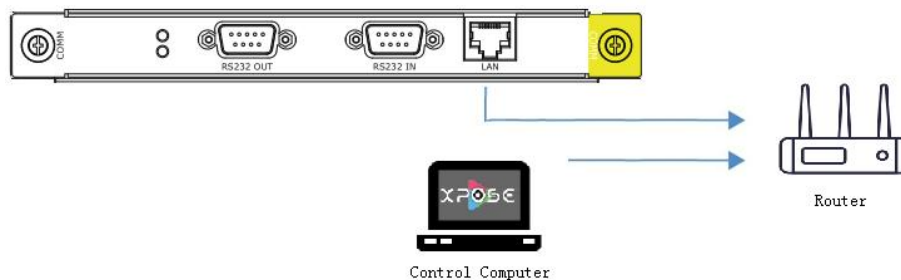

---

## 2.5 Connect PVW Module

Q16pro series supports preview input source via control computer or output image via monitor.

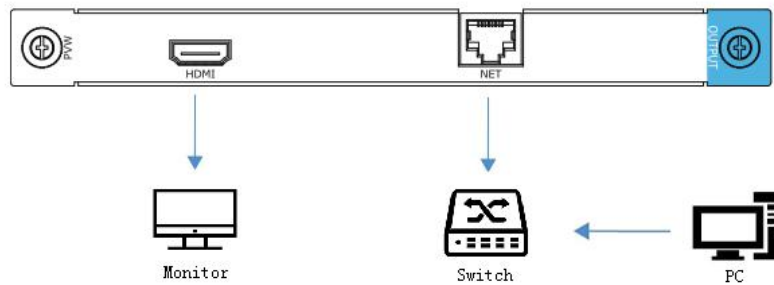

**LAN:**preview input and output

**HDMI monitor:**preview input source

## 2.6 Turn on Your Q16pro

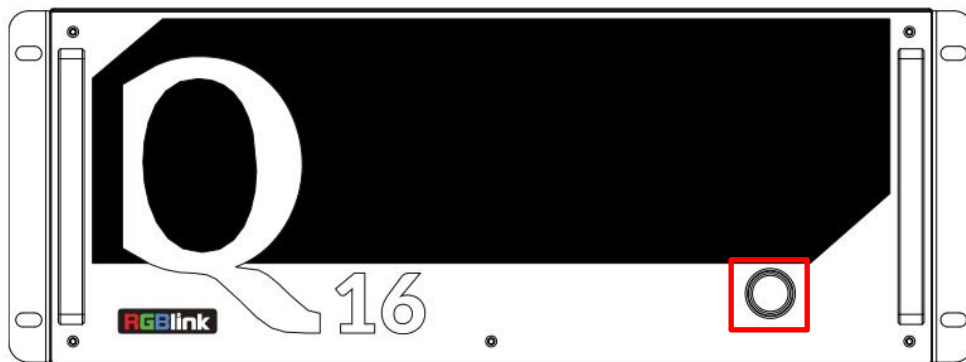

After connection,slightly press the power button in the front panel to turn on Q16pro.

---

# Chapter 3 Use Your Product

---

## 3.1 XPOSE 2.0 Installation

**Note:** The following XPOSE operation takes Q16pro-4 as an example, and other U models operate the same except for the difference of interface.

### Environment Requirements:

#### Window

Processor: 1 GHz or above 32 bit or 64 bit processor

Memory: 4 GB or more

Graphics: Support Direct X9 128M or above (open AERO effect)

Hard disk space: Above 16G (primary partitions, NTFS format)

Monitor: Resolution must be 1920×1080 pixel or above(it can not display normally if the resolution is lower than 1920×1080)

Operating system: Windows 7 or above (full version, not Ghost version or compact version)

CPU:i5 and above

#### Mac

Monitor:Resolution must be 1680×1050 pixel or above(it can not display normally if the resolution is lower than 1680×1050)

CPU:i5 and above



1. Double click , it will pop-up the installer language box, select the language, for example, select "English", and click "OK" to confirm.



2. Click "Next" to install



3. Click "Browse..." to select the XPOSE software install location

Click "Install"

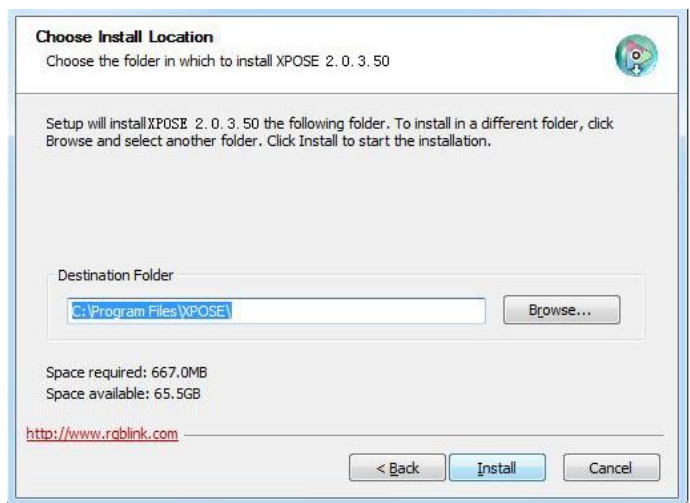

4. During installation, it will pop up the window of Install Shield Wizard for Virtual Com port

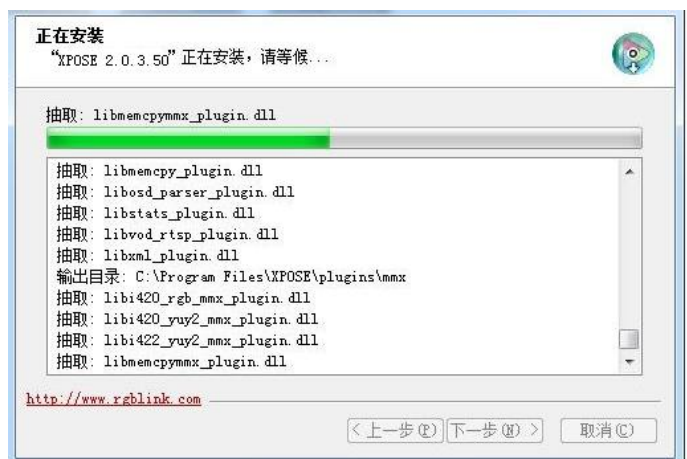

5. click "Next"

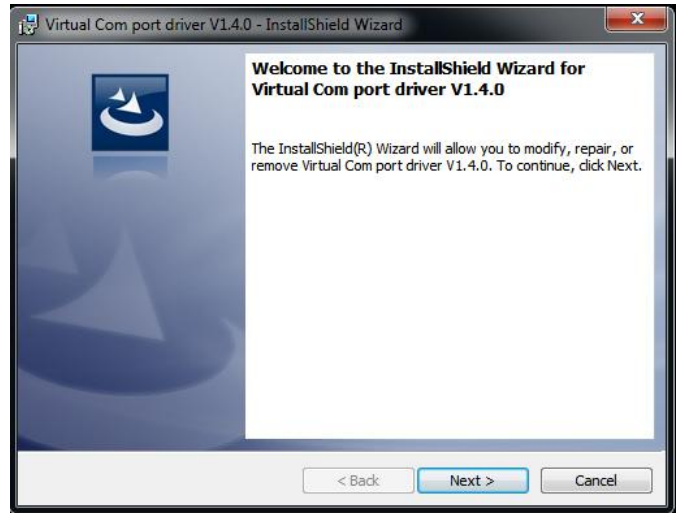

6. Then click "Install", as shown in the figure

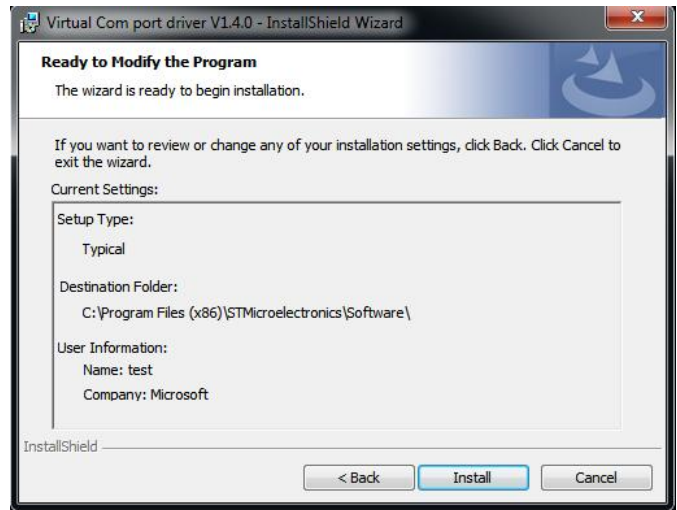

7. Click "Finish" and complete the installation, as shown in the figure below

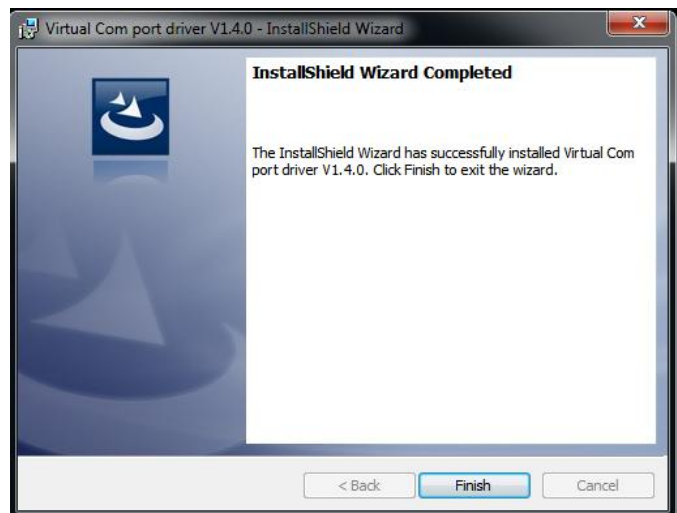

8. Click “Finish” and is ready to run the XPOSE software



## 3.2 XPOSE Operation

### 3.2.1 Login in XPOSE



Double click this icon ,and enter the log on interface as follow

The initial language of XPOSE 2.0 is self adjusted based on the operation system language of the computer. Click Register and fill in the blank with first name, last name, email, company and country and then click Register Now.

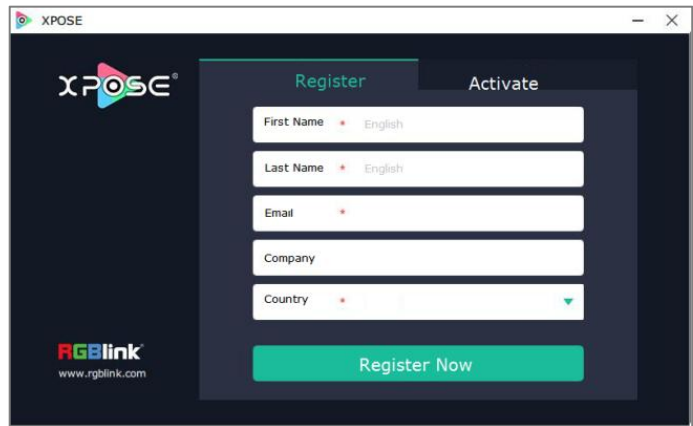

Please note that the email shall be invalid and complete otherwise Registration&Activation code cannot be received.

Click **Activate** and scan the QR code an email from **RGBlink Registrations** will be sent to the **Register** email address.

Type in the activate code and confirm.

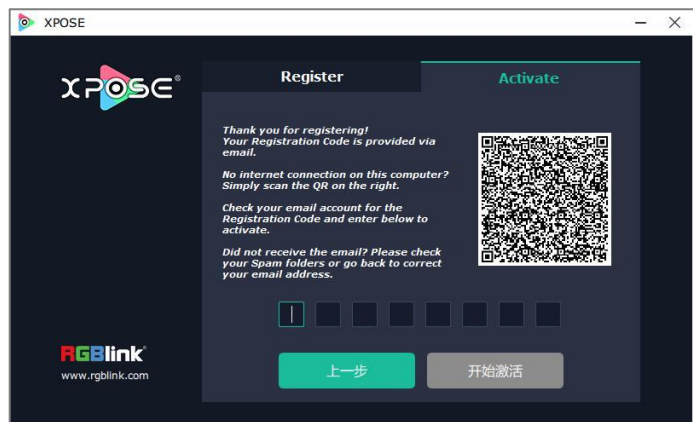

Type in the activate code and **confirm**.

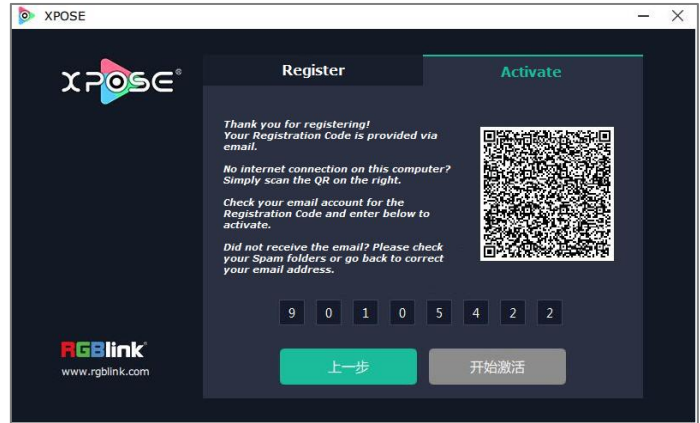

Keep the user name as “Admin” and password blank and then click **Start Now**.

If exact Name and Password are needed, users can set up them in Authorization Setting under System Setting.

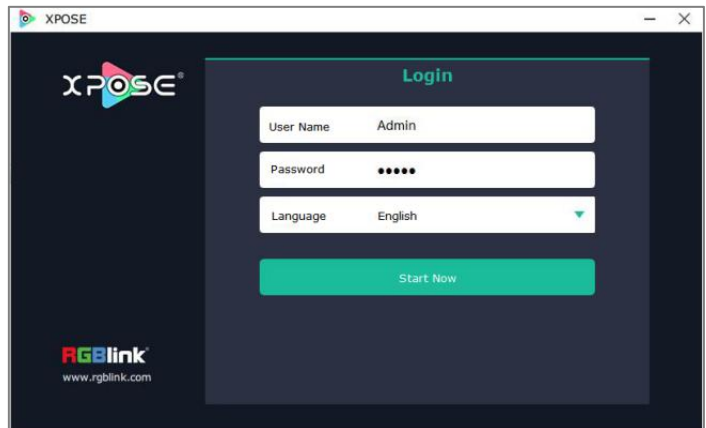

After login, users can find the management including:Topology Diagram,Search,Display System,Layer Management, Preset Management, Keyboard Settings. The details of each hierarchy will be described hereafter.

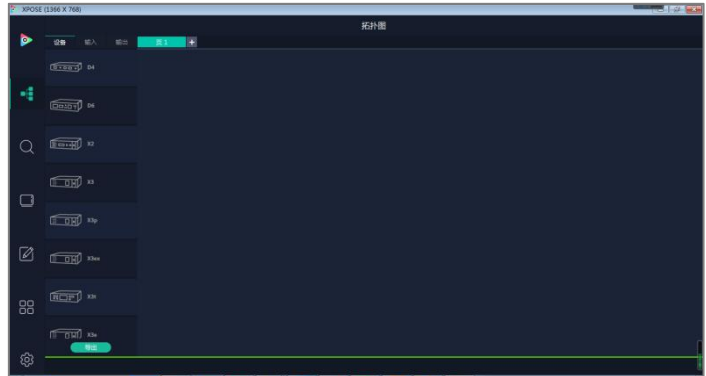



## 3.2.2 System Setting

Click  to enter <System Setting>interface.

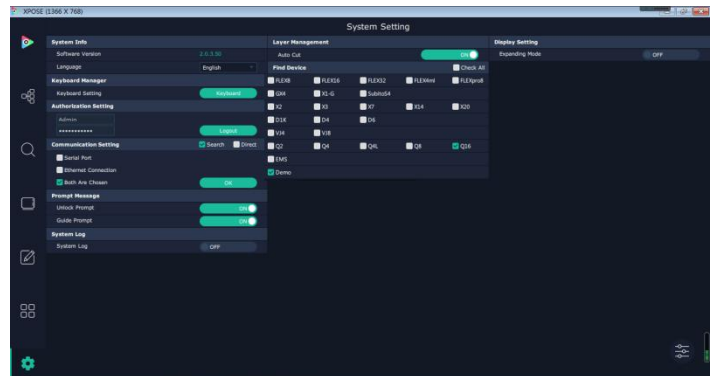

**Find Device :** New version of XPOSE 2.0 is blank default in Find Device. Users are supposed to choose the device needed in System Setting.

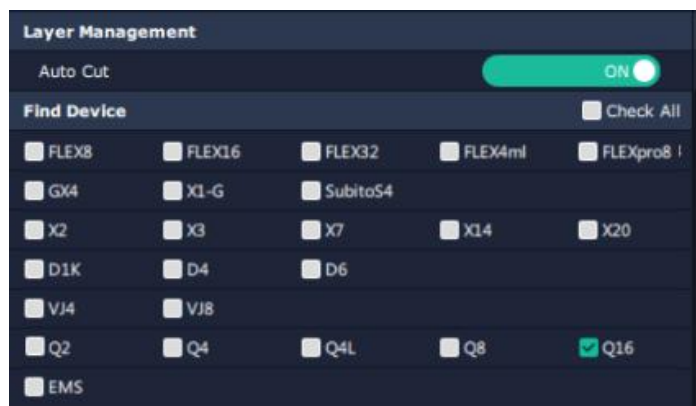

**Software Version:** check current version

**Language:** Chinese/English/Russia

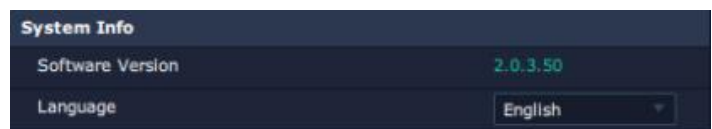

**Keyboard Management:** click <keyboard> it will redirected to keyboard setting window.

Keyboard setting is designed to fit for different operation system such as Windows and Mac. Users can set short cut keys.

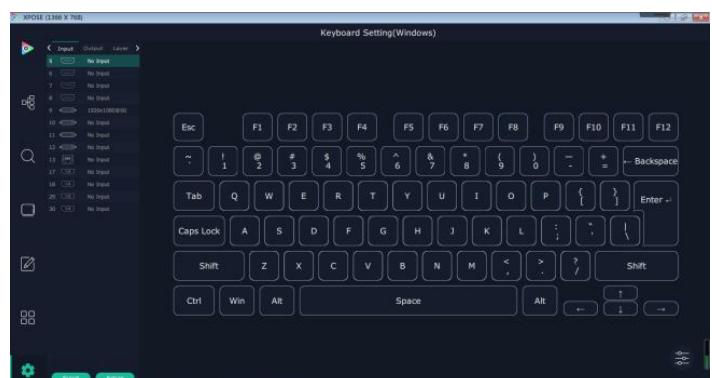



Drag Input, Output, Layer and Preset from the list to the keys you desired as shown in the figure:

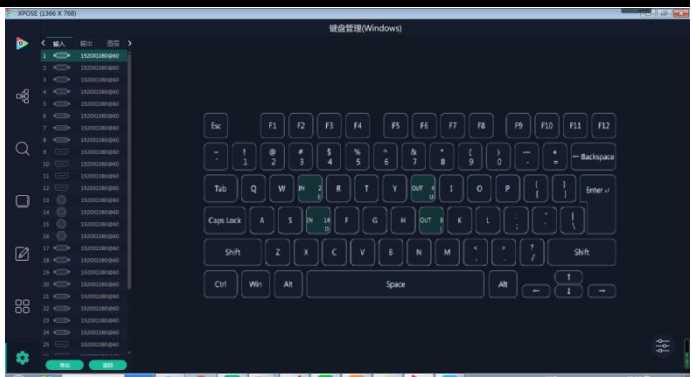

Please note the keyboard area where allows to set short cut keys



If the setting goes wrong or no need for short cut keys

any more, click  to clear some keys or clear all.

**Clear:** is to clear some keys, the keys need to selected before hand.

**Clear all:** is to remove all already set short cut keys.

Users can also save the keyboard setting as script.

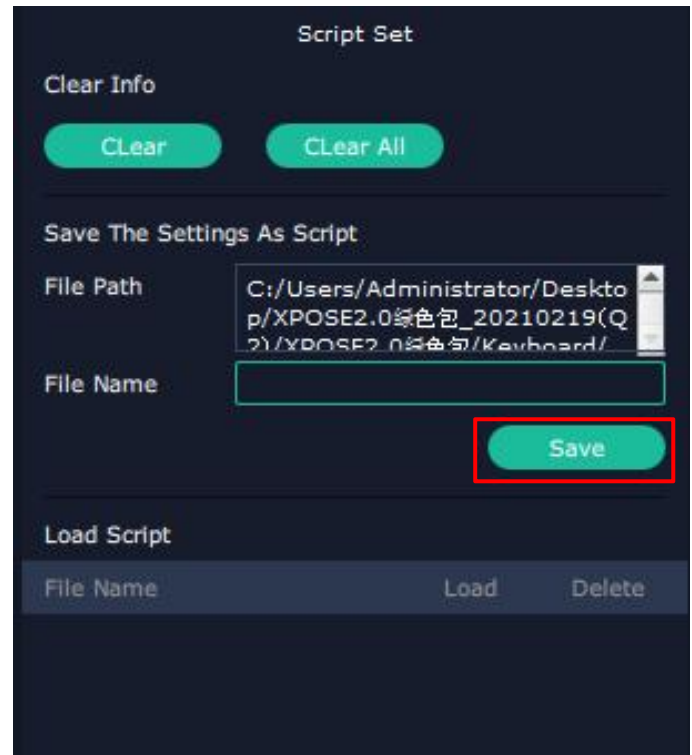

## Script Set

**File Path:** Save the current keyboard Settings in the script to the local path

**File Name:** script file name

**Load Script:** Load/Delete

Click Return to back to <system setting>

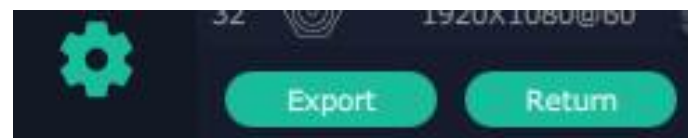

**Communication Setting:** The default is <search>, if it is <direct>, users need to type the corresponding IP address

**Serial Port:** search only those connect via serial port.

**Ethernet Connection:** search only those connect via ethernet.

**Both Are Chosen:** click both, both connections change synchronously.

**Prompt Message:** open and close unlock prompt and guide prompt.

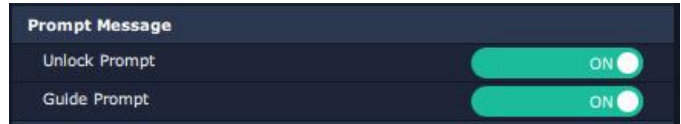
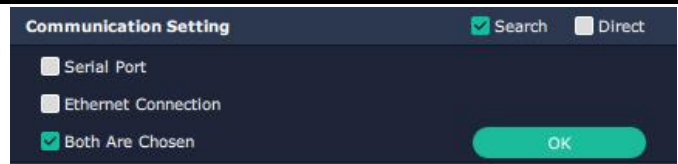

## Authorization Setting

Click  to open up the authorization entry.

**New:** Add new USER NAME and PASSWORD

**Edit:** Edit user name and password already built.

**Delete:** Delete user name and password already built.

**Permission:** functions on this XPOSE 2.0 on this computer that the users are allowed to operate. Click the green block to remove the function not to be permitted.

Click “new”, type in User Name and Password.

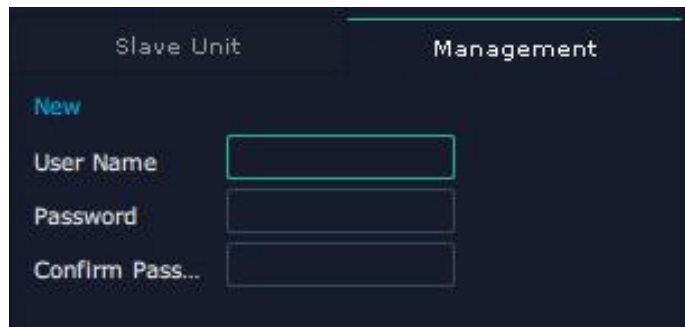
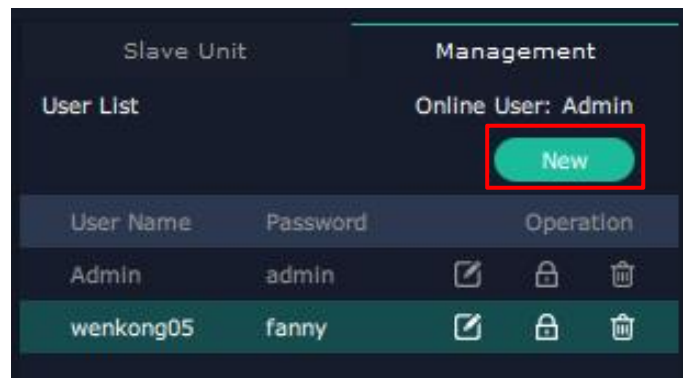



Authorization Set: click on the function that

allows other users to take action

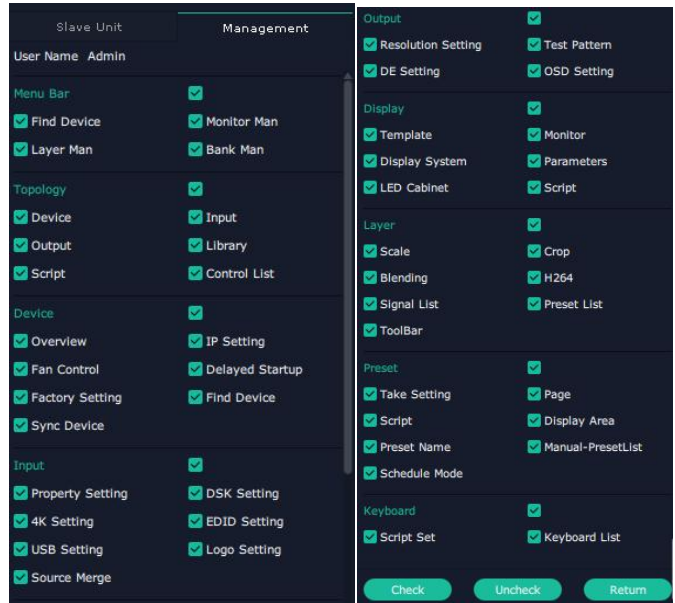



## Slave Unit:

Click **Slave Unit**

Slave Unit is to control multiple devices

simultaneously, which are connected to same network. (“In the same network” means that the third section in the IP address digits are the same )

XPOSE do operation on one device, same operation synchronized to other devices. For example, there is another devices linked to the same network, one with IP IP192.168.0.45

1. Set device numbers;
2. Select the IP of the device in the drop-down menu for Device IP
3. click **ON**,the tow device are connected when the red pot  turns to be green one .
4. click **OFF to disconnect**, it could not control two device at the same time.

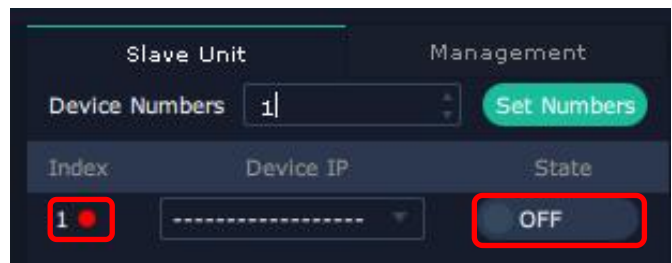
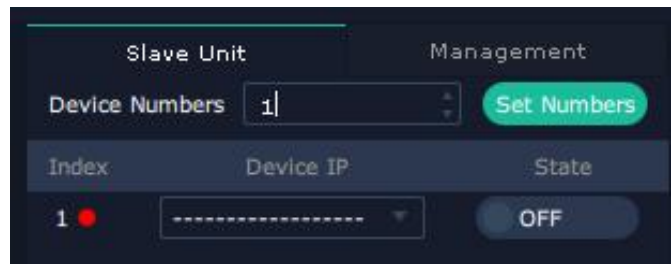

### 3.2.3 Output | Input | Overview

#### Device Connection

1. Click the device you need in the <All Devices> list, such as

Q16pro SN: 8043, IP: 192.168.0.114

2. click  in the <Chosen Device>.

The rear panel can be seen after connection

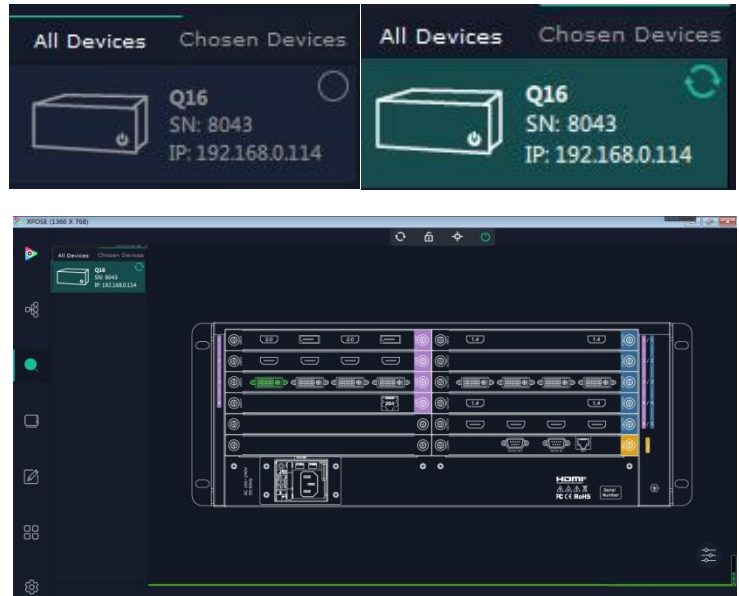

**Note:**  purple tip indicates input,  blue tip indicates output,  yellow tip indicates communication.

#### Output Setting

##### Resolution

Click any output port, the board where the port locates is selected. Users can do settings to the port now.

A red rectangle flashes around the chosen port when it is clicked.

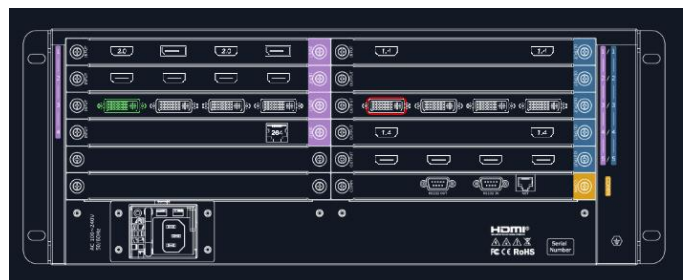

Standard Resolutions can be chosen as shown in the right figure.

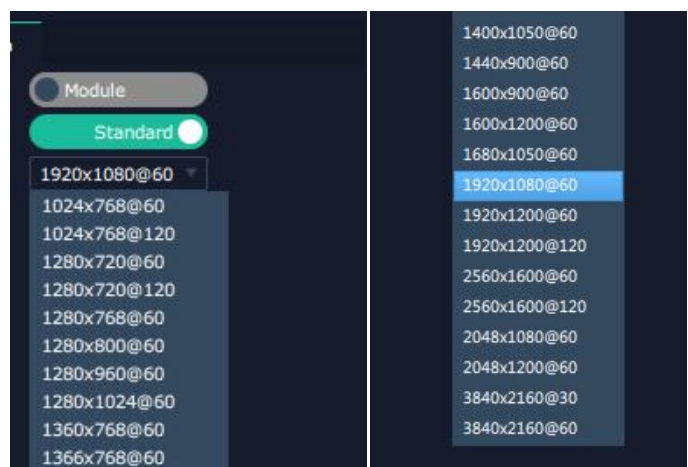

## Customize Resolution

Q16pro supports to customize output resolutions. Click any output port and type in width,Height and Refresh Rate.



## OSD:

Q16pro module which supports OSD as shown below:

- 2K HDMI Output Module(with OSD and background)

**Order Codes refer to 4.2**



**Output port** : current output port

**Status** : ON/OFF OSD

**Screen Group** : current group

**X/Y**: the starting horizontal and vertical position

**Width/Height** : the horizontal and vertical size of the text

**Font**: font of the text,all fonts installed in the computer is available

**Font Type** : Normal,Italic,Bold,Bold Italic

**Font size** : 0-300 pixels

**Color**: font color



**Background** : Transparent  
**Color**: background color  
**Scroll Speed**: 0-16  
**Scroll Direction**: Scroll Off, Scroll Left, Scroll Right  
**Input Text**: The exact content of the text.  
 After setting, users choose **Save OSD**,**Clear OSD**  
 (if the setting is not desired) or **Close All OSD**

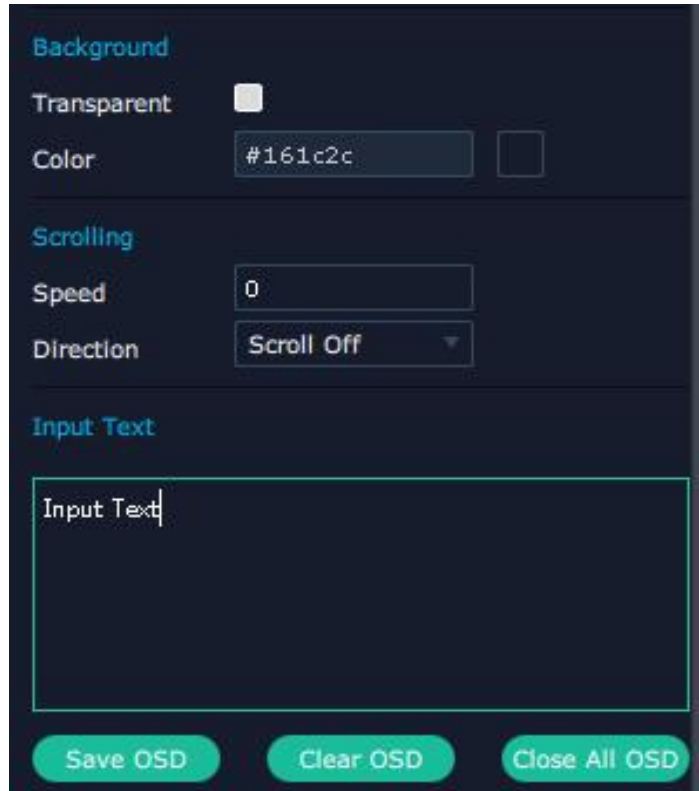

### Steps of OSD Set are as follows:

**Precondition:** The Display Management of output ports has been completed before the OSD Set.

1、 **Open** OSD Status.

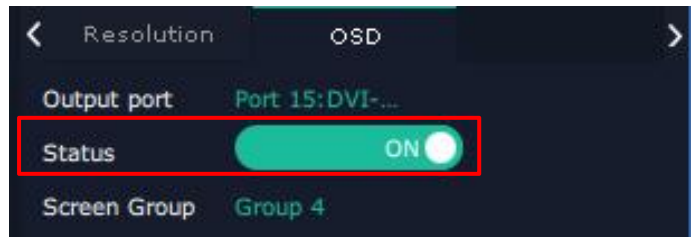

2、 **Position:** If the width of a single output is 1920 and the OSD will be displayed on the screen which is spliced by four outputs horizontally, then type 7680 for width (that is, the width of the four outputs).



3、 **Font:** choose font type,size and color.

4、 After all settings done,click<**Set**> and the OSD will be displayed on the screen.

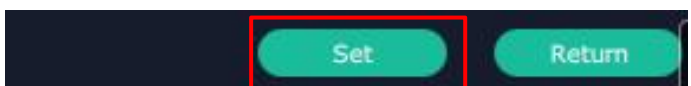



## Input Setting

Click any input port in purple area, the board where the port locates is selected. Users can do settings to the board now. A red rectangle flashes around the chosen port when it is clicked.



Click to open <Property>and<EDID>



## Property Setting

**Input Port:** chosen port

**Scale:**

**X/Y:** the starting horizontal and vertical position

**Width/Height :** the horizontal and vertical size of scale



## EDID

**Input Port:** chosen port

**Basic Parameters:**

**EDID Template:** RGB-DVI or RGB-HDMI

**Monitor Name:** type the monitor name

**Width/Height/Frequency:** type in custom parameters to meet your needs.

Q16pro's modules which support EDID are as follows:

- HDMI Input Module (with audio)
- HDMI Input Module
- DVI-M Input Module
- DVI-I Input Module
- 4K@60 Input Module

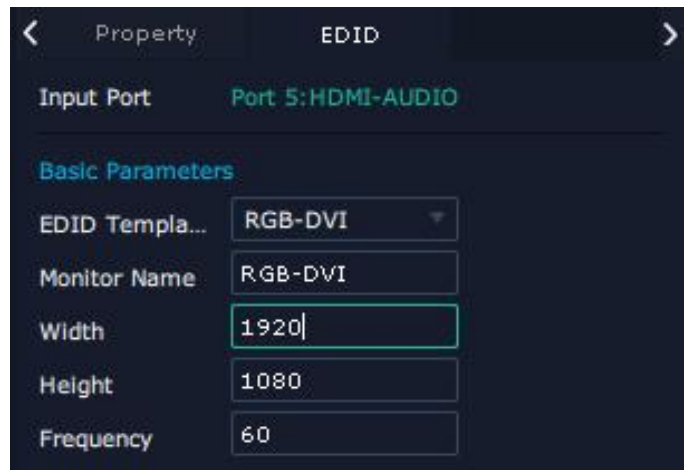

**Order Codes of module refer to 4.2**

## H.264 IP Settings

When there is H.264 input module installed on Q16pro, through the module, Q16pro is able to search and take the video signal from webcam in the same local network.

1. Click H.264 port, To make sure H.264 module take effect, **IP setting** is required. IP of H.264 should be in the **same network section**, for example: network IP is 168.192.0.1, IP of H.264 shall be 168.192.0.X (X≠1)

2. Tick “URL” first and then fill in the URL of camera (Note: URL address must be in RTSP format. The account and password of camera should be included in the address. e.g: `rtsp://admin:admin@192.168.1.176:554/cam/realmonitor?channel=1&subtype=0&unicast=true&proto=Onvif`, in which admin:admin is the account and password of camera)

3. If only one camera’s address is set, click “Set” in the right directly; If several cameras’ address are set together, click “set” in the bottom of the page after all the address being finished. (Note: For the account and password will be hidden automatically after click “Set”, repeatedly click “Set” will result in the error address)

4. The camera signal can be seen in the IPC list in <Display Management>. Drag and drop the IP Port 1.1 to the display directly, four camera signals will be in one group to show the four image in only one layer; Drag and drop the IP Port 1.11/1.12 to the display respectively, the camera signals will show the image

## Overview

Click Return Return, there are overview, IP, Factory Setting.

**Device Info:** users can check version and MAC information

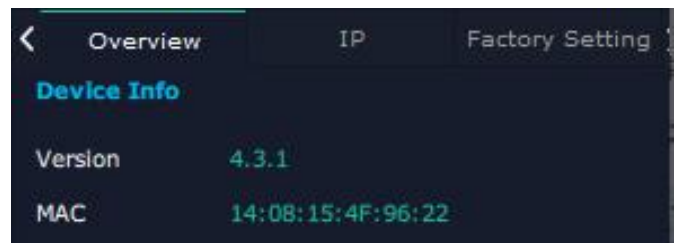
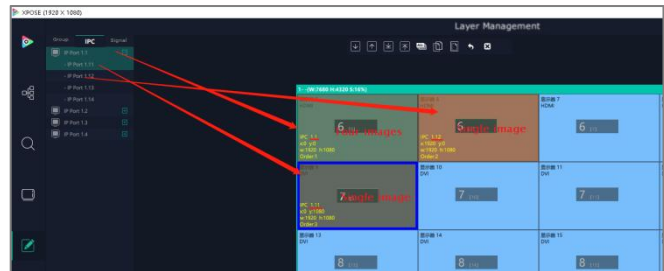
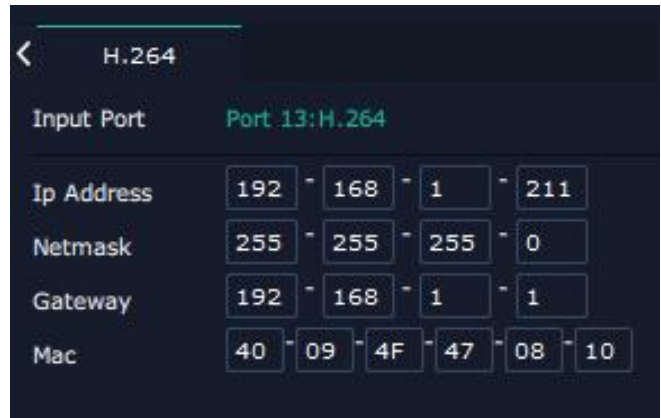
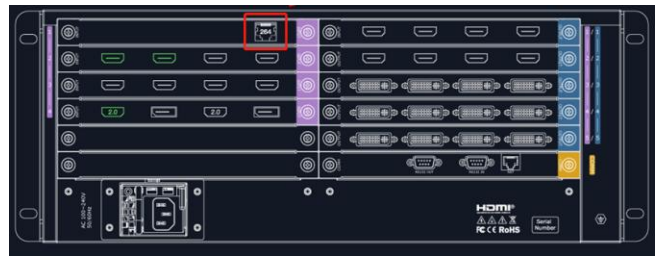



**Input Module Info** : users can check current input module name and MCU version

“...” indicates that there are no input modules,as shown in the right figure.

Index	Module Name	MCU Version
1	HDMI 2.0	V4.0.7
2	HDMI	V4.0.8
3	DVI	V4.0.3
4	H.264	V4.0.3
5	HDMI 1.4	V4.0.3
6	----	----
7	----	----
8	HDMI 1.4	V4.0.3

**Output Module Info** : users can check current output module name and MCU version

Index	Module Name	MCU Version
1	----	----
2	----	----
3	DVI	V4.0.3
4	----	----
5	HDMI	V4.0.3

**IP** : Show IP Address, Netmask, Gateway  
IP default:192.168.1.200

Overview IP Factory Setting

IP Address 192 - 168 - 000 - 020

Netmask 255 - 255 - 255 - 000

Gateway 192 - 168 - 000 - 001

⚠ Note that after modifying IP, the device needs to be powered off and restarted!

**Note:** after modifying IP, the device needs to be powered off and restated in 30s.

**Factory Setting**

Overview IP Factory Setting

⚠ Note that after factory reset, the device needs to be powered off and restarted, and the IP will be reset to 192.168.1.200!

**Note:** After factory reset,the device needs to be powered off and restarted,and the IP will be reset to 192.168.1.200.

## 3.2.4 Display Management

Display System is for users to set layout of outputs.



Click this icon first and then click  enter the interface.

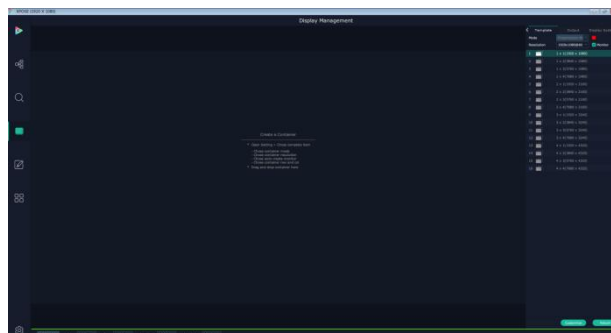

### Container:

Container here means the Display Area, for example it could be a formed LED screen or an array of LCDs.



### Template

There are 16 types of basic “Display Area” which is used to contain output interface, and could be regarded as layout of output.

**Drag** a template to create a container in other word a display area.

### Mode

At present, there are Presentation Mode, PST+PGM Mode, Rotation Mode and Edge Blending In XPOSE2.0 .

Each mode is marked in different color and provided with fitted templates

**Q16pro : Presentation Mode only.**

Users can do operations like splice under Presentation Mode.

### Resolution

Users can choose output resolution as shown in the figure.

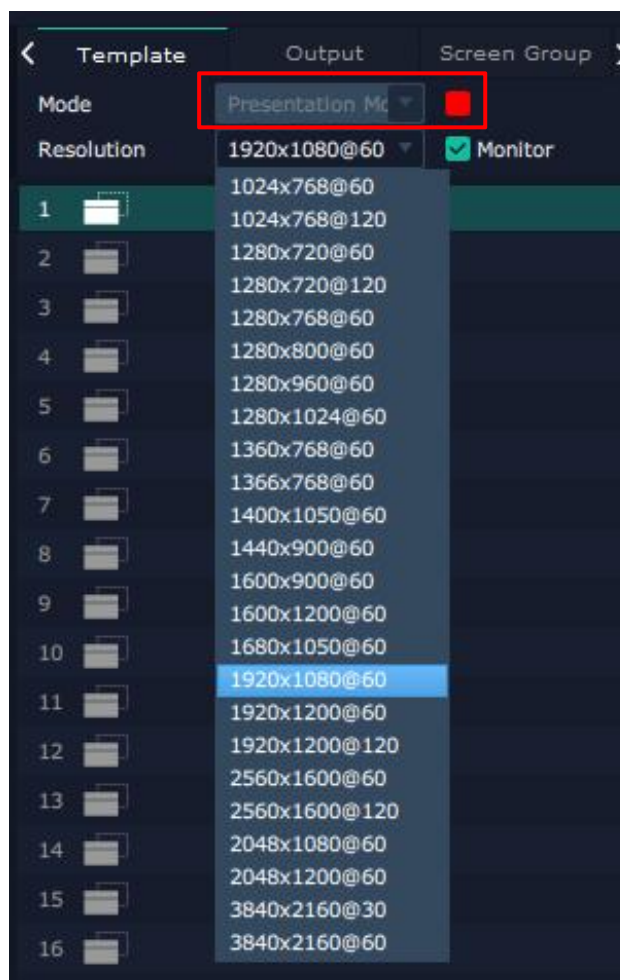

## Customize Container

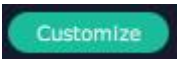

Click this icon at the bottom of template list.

**Monitor Layout:** Auto or Manual

**Steps of create container are as follows:**

1. Fill in H Total/V Total and Row/Column, it will calculate H item and V item automatically. For example, if you would like to create a container with 2 rows and 3 columns and each display has a width of 1920 and a height of 1080, the total width will be 5760 and the total height will be 2160.

2. Click <Create>, the container will display in the interface, and shows the width and height of each Display.

3. Click <Save> to save the container.

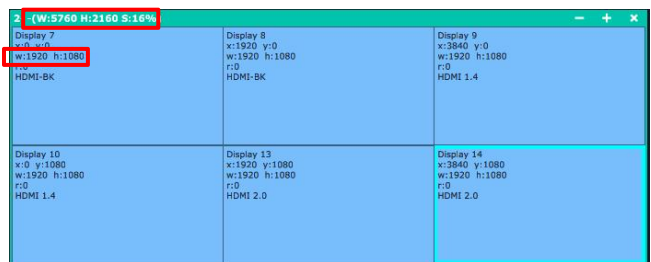
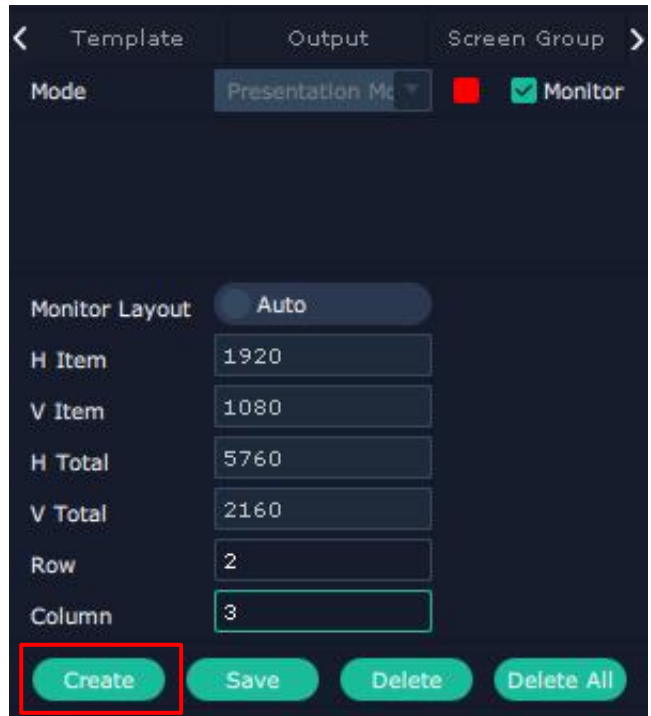

## Container Adjustment

1. **Move:** Drag the boarder of the display area to move its place in the interface.

2. **Scale:** Click icon to shrink, Click to enlarge the proportion of display area on interface.

3. **Cancel:** Long pressing the to cancel the screen group.



## Display

### Output List:

White one: available

Gray one: unavailable

### Operation Steps:

Left-mouse click the output and drag it to the display of the set container.

### Replacement:

Drag and drop the output into the corresponding Display. The output being replaced will turn from gray to white in the list.



## Screen Group

Q16pro supports to manage 6 screen groups at most on XPOSE.

It allows users to edit the name of the Screen group that has been created just click the

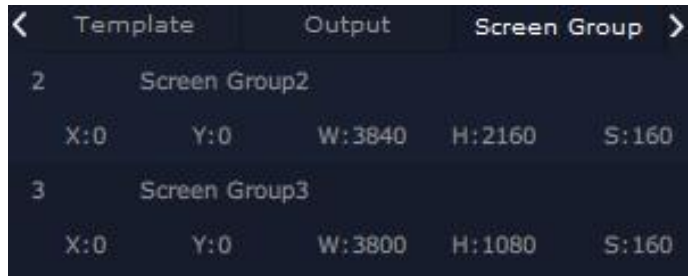

## 3.2.5 Layer Management

Layer Management is designed to manage the layer

of each monitor. Click this icon  to enter the interface:

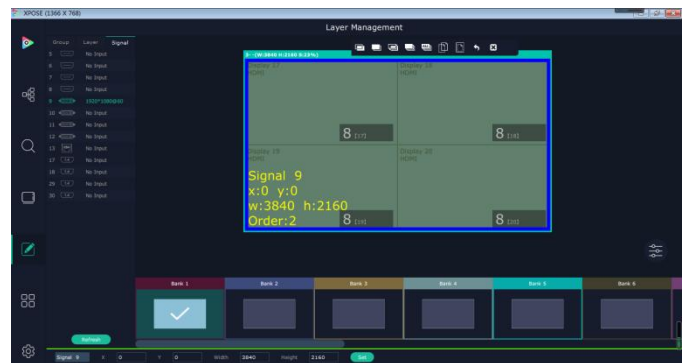

## Group

When enter Layer Management interface, the window is blank. The screen group created in Display System shall be dragged from the **Group**.

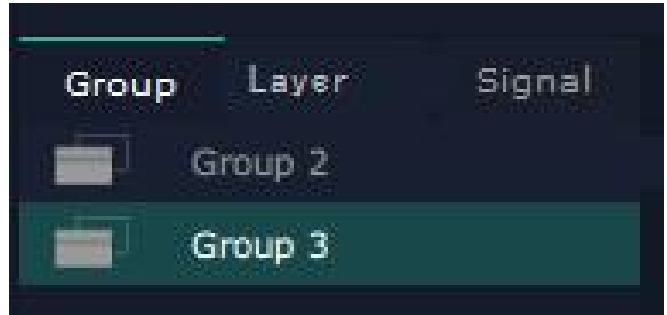

## Signal

Signal list, showing all input signals and resolutions currently. Drag the signal to the display.

click , users can rename the input signal and then

click  to confirm.



## Audio

Q16pro supports Audio Input/Output Module, which should be inserted into the slots supporting both input&output module.

1. Select a bank you would like to add audios; Every bank and every layer can be added different audio inputs&outputs.
2. Drag audio inputs from “Signal List” to audio outputs as shown in the right figure; You can also drag a new audio input to replace the previous one. The relation between audio input and output is unique;
3. Click left mouse to adjust the volume in “volume bar” shown in the audio output.



## Layer

**Layer number:** Numbers in the corner is to show how many layers at present allowed to put in the output.

A 2K signal occupies one layer, and a 4K2K60 signal occupies four layers

The number in the red rectangle on the right figure represents the number of layers that can be placed at the output.



### Layer Adjustment:

there are two ways to adjust layer.

#### 1. Use the bar under the interface

Choose one layer and the bar shows its signal source, type in position and size. click Set to confirm.

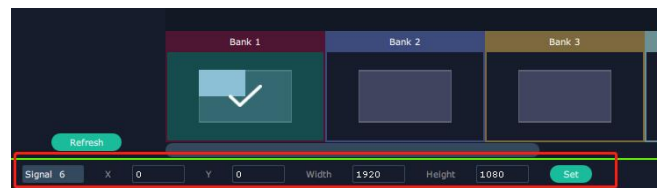

#### 2. Layer Scale and Crop

Choose one layer needed to be adjusted, and type in its position and size.



this icon means data related, when width is changed, height will be changed as same proportion.



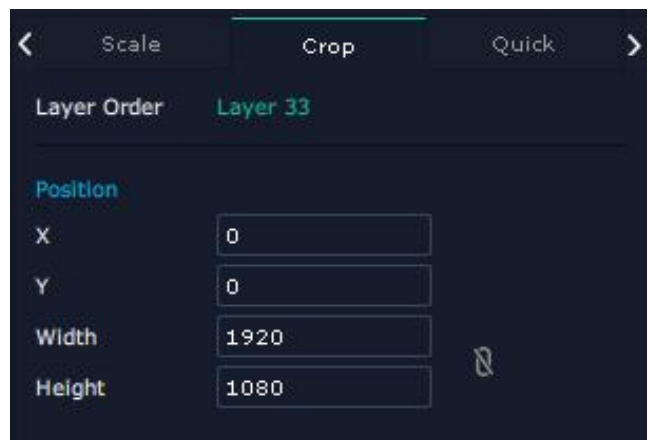
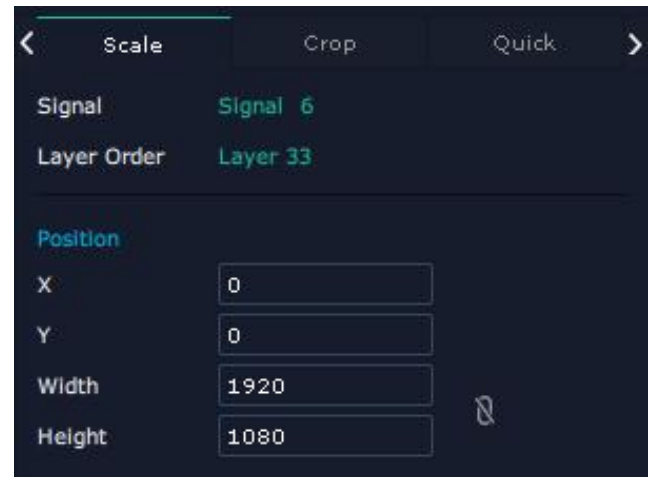

this icon means data not related, width and height need to be filled respectively.





### Layer Movement



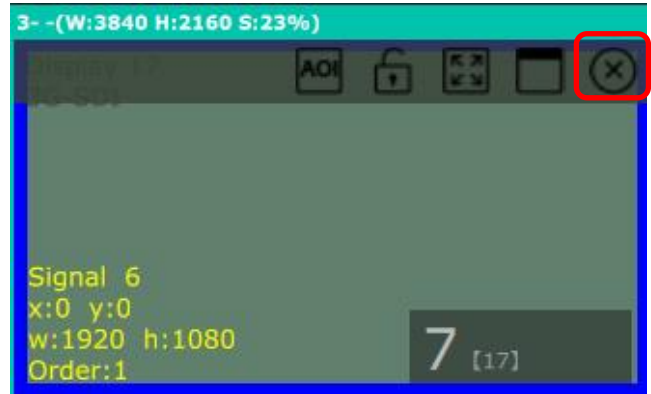

Place the cursor on the layer, it turns to a palm icon , press the left of mouse, the icon turns to a fist , moving the mouse can drag the layer.



### Layer Remove

Click the cross on the top right of the layer to remove the layer if needed.

### Layer Set

- :to crop the layer
- :lock the layer to prevent misoperations
- :max to cover up the monitor.
- : cover up all monitors in the same screen group with the one signal.

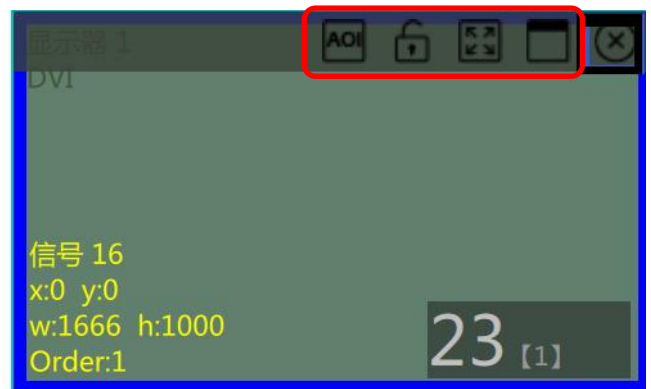









### Layer Copy

Press Ctrl and mouse left at the same time, move the mouse the layer selected can be copied and place in any monitor in the same Display Area but it doesn't work when cross over display area.

### Other Operation on Layer

 Use the tools bar on top of window to do such operations

	Layer Backward		Layer to Top		Paste Selected
	Layer Forward		Select All		Cancel Selected
	Layer to Bottom		Copy Selected		Delete Selected

## Quick

Quick is to set layer layout quickly.

1. **Monitor:** choose the monitor you would like to set
2. **Source:** Signal
3. **Drop Area:** Drag the source from the Signal List to the Drop Area. Drag as many signals as you need, such as signal 1 and signal 2, into the drag area.
4. After setting, click **<Set>** to confirm and the layout will be shown on the interface as shown in the right figure.

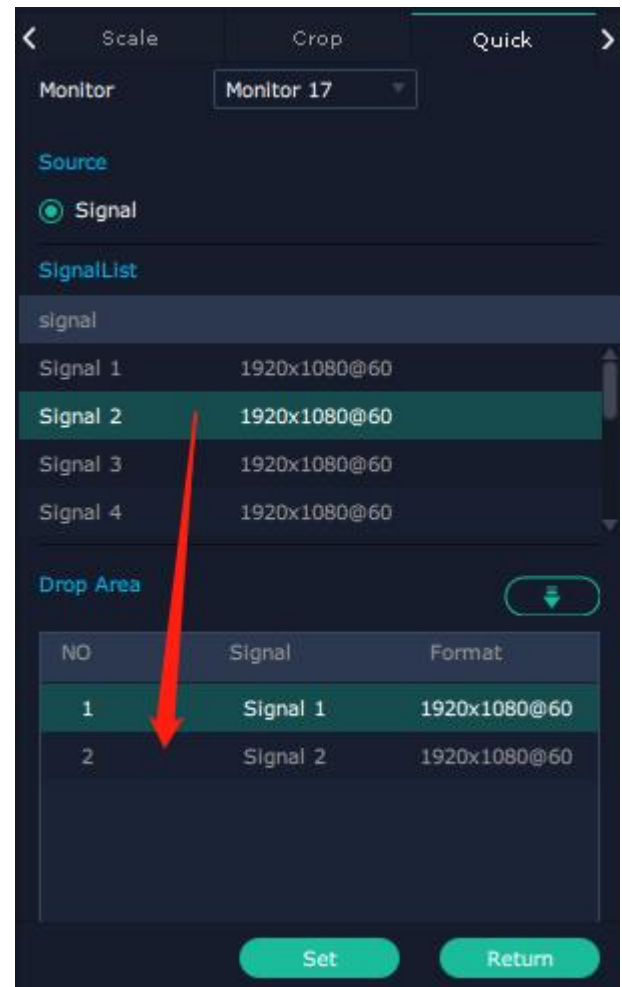



## Stream

H.264 Module supports to preview image.

1. Turn on Layer Preview,Input Preview,Scene Preview or Expand Preview according to the actual need.
2. Turn on H.264,and users can preview the image as shown in the right figure.

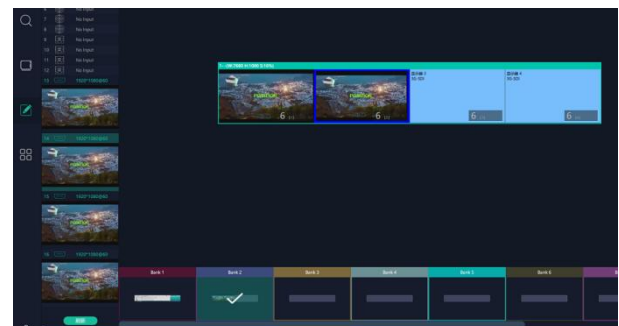
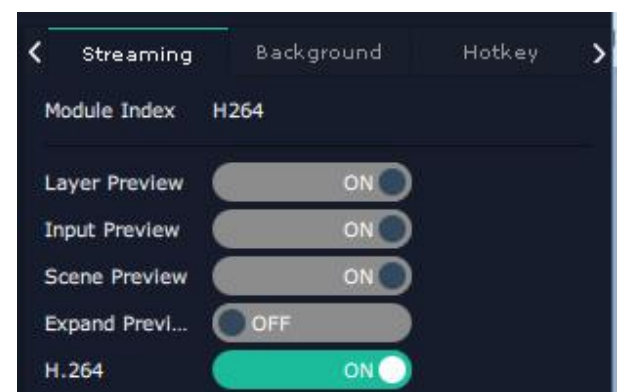
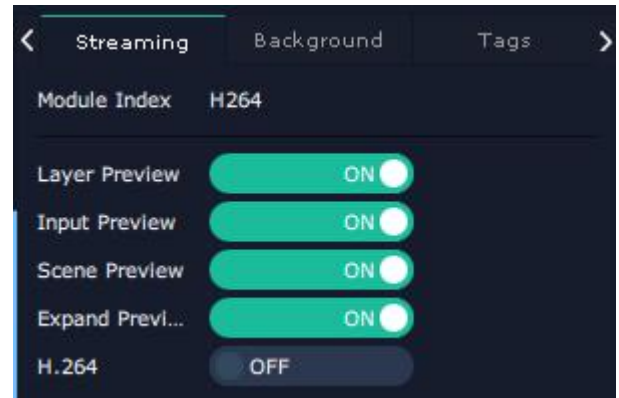

**Note:** H.264 is the master switch. If the user turns on H.264 first, it cannot be set successfully.

## Background

Q16pro's modules which supports background set are as follows:

- 2K DVI Output Module (with OSD and background)
- 2K HDMI Output Module (with OSD and background)

**Order Codes of modules refer to 4.2**

**Operation steps are as follows:**

1. Turn on Edit Status;
2. Click "**Browse**" to choose picture.
3. Position: fill in the X/Y and Width/Height.
4. After settings,click"**Set**" to confirm and click"**Clear Image**" to clear the image if needed.
5. After click"**Set**",the background is set successfully when red progress bar at the bottom of the interface turns to green.

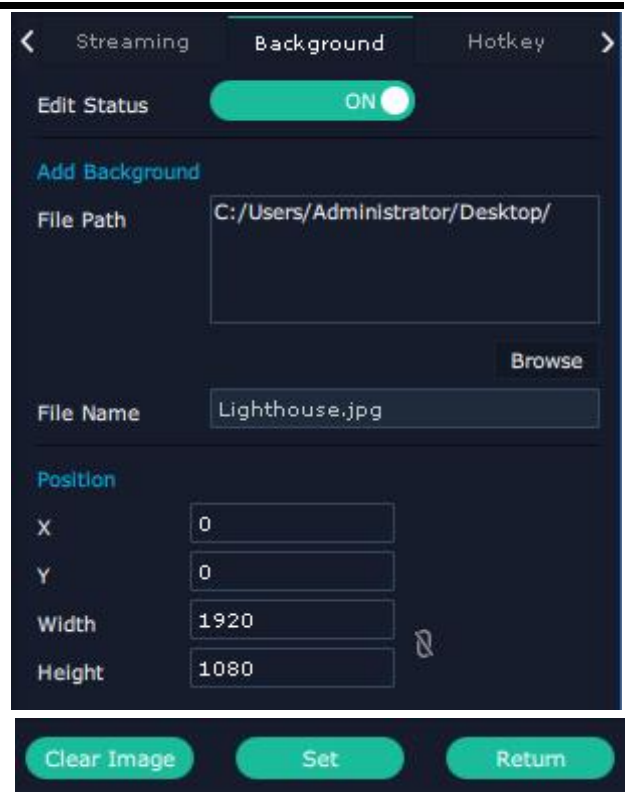

## Hotkey

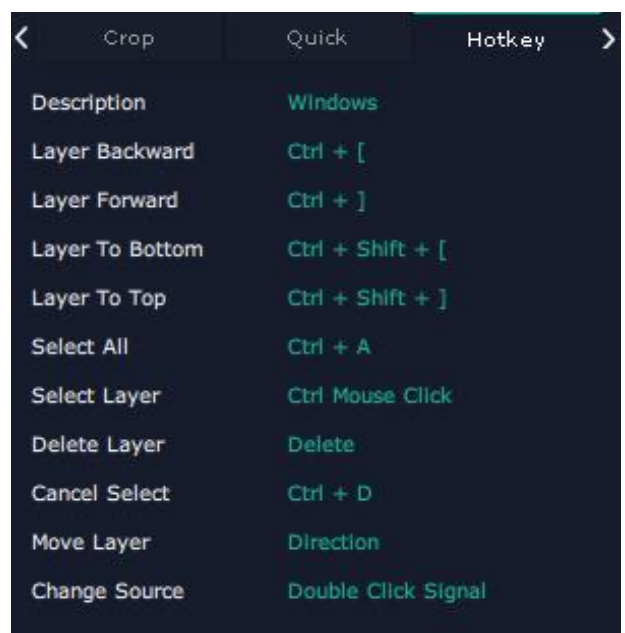

### 3.2.6 Preset Management

Preset Management is designed to switch bank (scene setting done in last step).

Preset Management Mode:

1. Manual Mode
2. Schedule Mode

#### 1. Manual Mode

The chosen scene will be displayed in the main interface, and the PGM screen is in the first in the Bank Column.

#### Cut

Cut, switch from PST to PGM immediately

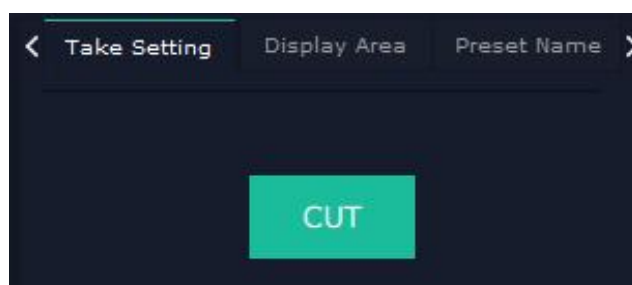
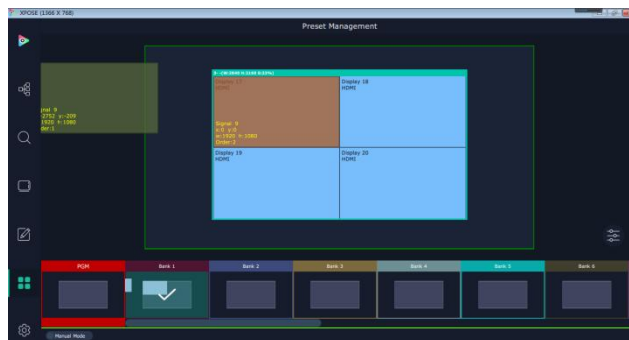

#### Script

Click<Script>,fill in the file name and click “Save”,the file can be seen in the <Load Script>

Click“Load”  to load the file into XPOSE.

Click“Delete”  to delete saved script.

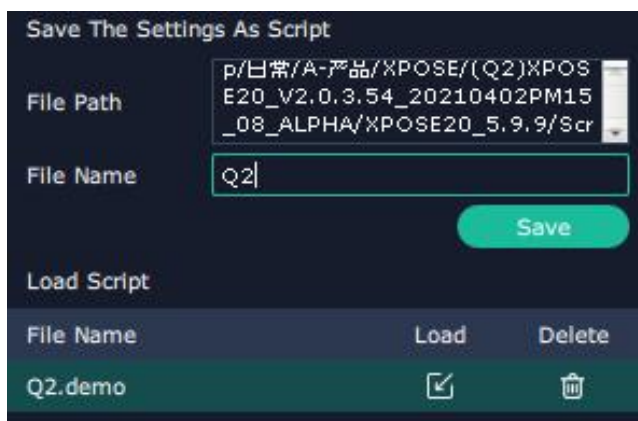

#### Preset Name

Select a bank and click Preset Name,fill in the blank after New Preset Name to rename a Preset (Bank)

Click the color block after Color Selection and choose a new color for the boarder of chosen bank.





## Hotkey



## 2. Schedule Mode

This mode is designed to set auto bank (scene/preset) switch.

Steps are as follows:

1. Choose the BANK
2. Fill in the “Start Time” and “End Time”
3. Turn on Daily Loop, and click “OK”
4. Click  to edit and  to delete.
5. Turn on “Loop Switch”

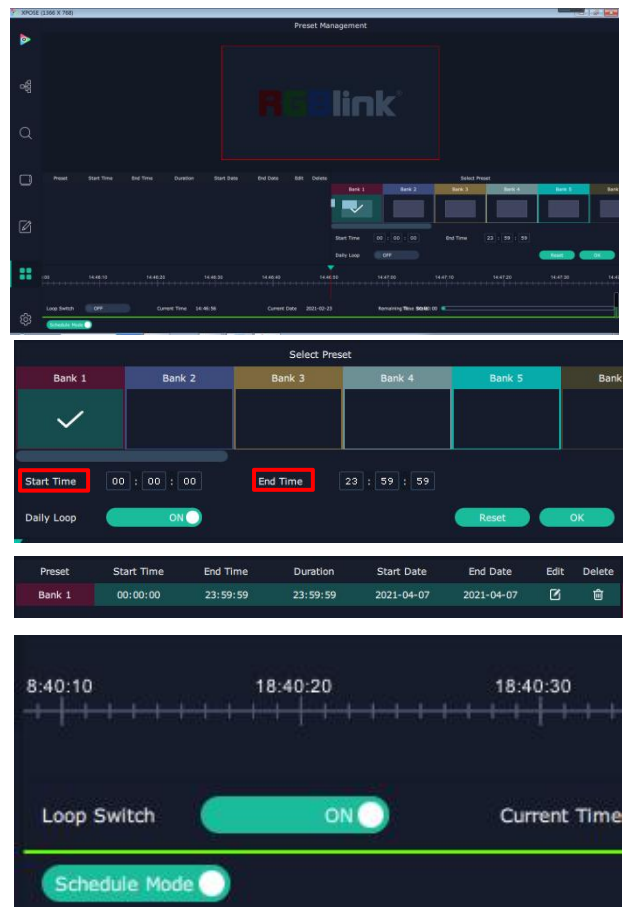

## 3.3 XPOSE APP Control

Q16pro support to load scene via XPOSE APP.(Note:The device and phone must be in the same network)

### Connect Q16pro and phone

Method 1:Connect wireless in the same WIFI

Method 2:Direct connection

(1) Install XPOSE APP in your phone first and then click

 to open it,click “search”

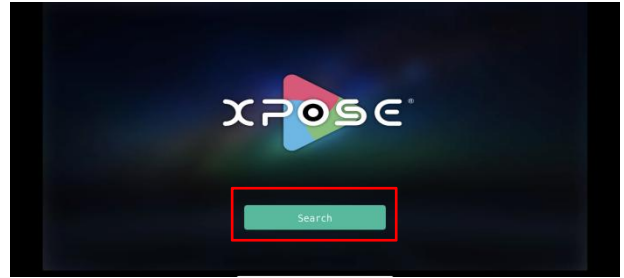

(2) Select Q16pro model and click the icon  in the top right corner

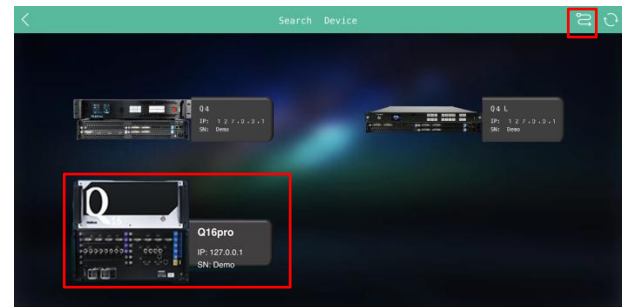

(3) Fill in the IP address of Q16pro,and then click “OK”.Now the device and Q16pro is connected.

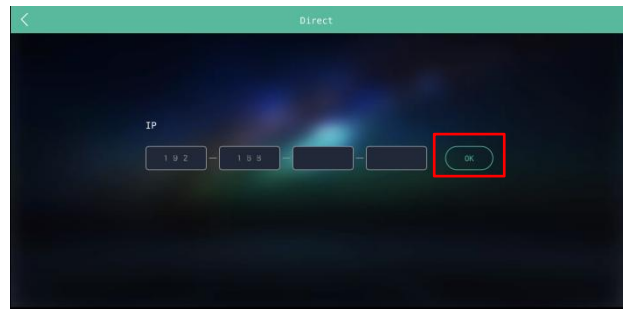

### Load Scene

Red indicates current scene,green indicates the save scene,white indicates blank scene

e.g: As shown in the right picture,it is in Group 1 Scene2, click 1 to switch to Group 1 Scene ;If you need to load scenes in other groups,select group first and then the scene.

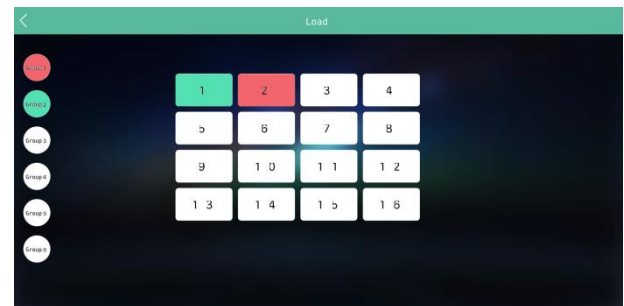

---

# Chapter 4 Order Code

---

## 4.1 Product Code

<b>711-0020-01-0-16</b>	<b>Q16pro-4</b>
<b>711-0020-04-0-16</b>	<b>Q16pro-8</b>
<b>711-0020-05-0-16</b>	<b>Q16pro-14</b>
<b>711-0020-06-0-16</b>	<b>Q16pro-18</b>
<b>711-0020-07-0-16</b>	<b>Q16pro-26</b>

## 4.2 Module Code

<b>791-0020-02-0</b>	<b>Q16pro Dual HDMI 1.4 Input Module</b>
<b>791-0020-03-0</b>	<b>Q16pro Quad DVI-M Input Module</b>
<b>791-0020-04-0</b>	<b>Q16pro Quad DVI Input Module</b>
<b>791-0020-05-0</b>	<b>Q16pro Quad HDMI 1.3 Input Module(with audio)</b>
<b>791-0020-07-0</b>	<b>Q16pro Dual DP 4K@30 Input Module</b>
<b>791-0020-08-0</b>	<b>Q16pro Dual DP1.2&amp;HDMI2.0 4K@60 Input Module</b>
<b>791-0020-10-0</b>	<b>Q16pro Quad HDBaseT 1080P Input Module</b>
<b>791-0020-11-0</b>	<b>Q16pro Single H264 IP Input Module</b>
<b>791-0020-12-0</b>	<b>Q16pro Quad 3G SDI Input Module</b>
<b>791-0020-22-0</b>	<b>Q16pro Quad 2K DVI Output Module</b>
<b>791-0020-24-0</b>	<b>Q16pro Quad 2K HDMI Output Module(with OSD&amp;background)</b>
<b>791-0020-26-0</b>	<b>Q16pro Quad HDBaseT Output Module</b>
<b>791-0020-27-0</b>	<b>Q16pro Quad 3G SDI Output Module</b>
<b>791-0020-28-0</b>	<b>Q16pro Dual HDMI2.0 Output Module</b>
<b>791-0020-30-0</b>	<b>Q16pro Analogy Audio Input&amp;Output Module</b>
<b>791-0020-31-0</b>	<b>Q16pro PVW Module</b>
<b>950-0001-00-0</b>	<b>Power Module (200W)</b>
<b>950-0011-02-0</b>	<b>Redundant Power Module(for 8U and above)</b>

# Chapter 5 Support

## 5.1 Contact us

[www.rgblink.com](http://www.rgblink.com)



### Inquiries

+86-592-577-1197  
info@rgblink.com  
rgblink.com/contact-us

### Global Support

support@rgblink.com  
rgblink.com/support-me



@RGLINK



/rgblink



+rgblink



/rgblink



rgblink



rgblink

### RGBlink Headquarters

Xiamen, China

Room 601A, No. 37-3  
Banshang community,  
Building 3, Xinke Plaza, Torch  
Hi-Tech Industrial  
Development Zone, Xiamen,  
China

+86-592-577-1197

### China Regional Sales & Support

Shenzhen, China

11<sup>th</sup> Floor Baiwang Building  
5318 Shahe West Road  
Baimang, Nanshan

+86-755 2153 5149

### Beijing Region Office

Beijing, China

Building 8, 25 Qixiao Road  
Shahe Town Changping

+010- 8577 7286

### Europe Regional Sales & Support

Eindhoven, Holland



Flight Forum Eindhoven  
5657 DW





+31 (040) 202 71 83

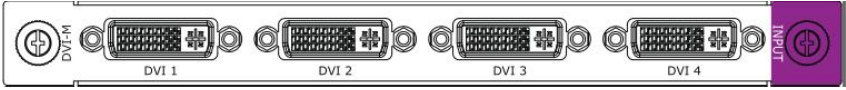
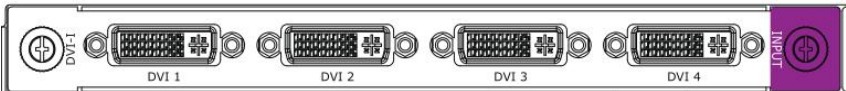
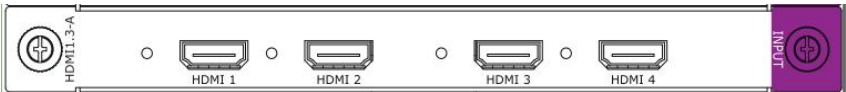

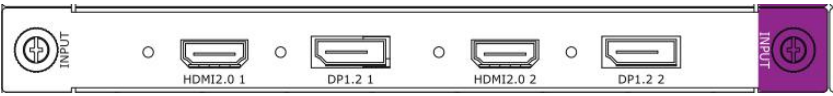
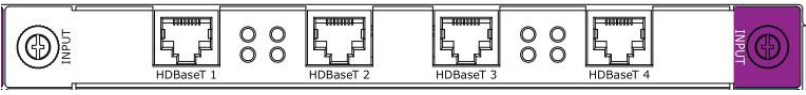

# Chapter 6 Appendix

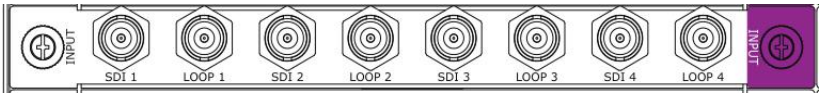
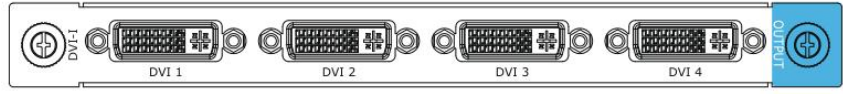
## 6.1 Specification

<b>Quad DVI-M Input</b>	
Connector Appearance	
Numbers of Input	4
Connector Type	DVI-I(compatible with HDMI/DVI/VGA/YPbPr/CVBS)
Input Resolution	800×600@60 ~ 1920×1200@60
<b>Quad DVI input</b>	
Connector Appearance	
Numbers of Input	4
Connector Type	DVI-I
Input Resolution	800×600@60 ~ 1920×1200@60
<b>Quad HDMI1.3 Input with Audio</b>	
Connector Appearance	
Numbers of Input	4
Connector Type	HDMI-A
Supported Standard	HDMI 1.3
Input Resolution	800×600@60 ~ 1920×1200@60
<b>Dual HDMI1.4 4K input</b>	
Connector Appearance	
Numbers of Input	2
Connector Type	HDMI-A
Supported Standard	HDMI 1.4
Input Resolution	800×600@60 ~ 3820×2160@30
<b>Dual DP input</b>	
Connector Appearance	
Numbers of Input	2
Connector Type	DisplayPort 1.1

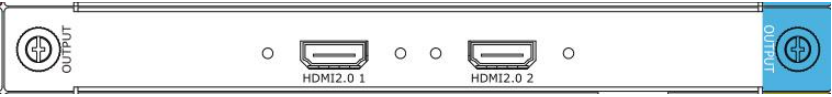
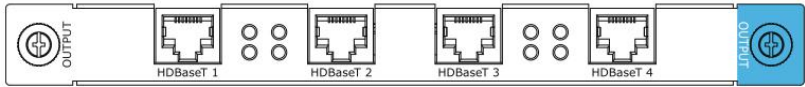
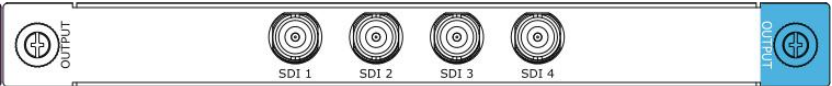
Input Resolution	800×600@60 ~ 3840×2160@30
<b>DP1.2/HDMI2.0 8K input</b>	
Connector Appearance	
Numbers of Input	4
Connector Type	2×HDMI-A   2×DisplayPort
Supported Standard	HDMI 2.0   DP1.2
Input Resolution	800×600@60~7680×1080@60
<b>Quad HDBaseT input</b>	
Connector Appearance	
Numbers of Input	4
Connector Type	2×RJ45
Input Resolution	800×600@60~1920×1080@60
<b>Single IP input</b>	
Connector Appearance	
Numbers of Input	1
Connector Type	RJ45
Input Resolution	800×600@60~1920×1080@60
<b>Quad SD/HD/3G-SDI input with loop out</b>	
Connector Appearance	
Numbers of Input	8
Connector Type	8×BNC (4 In   4 Loop)
Supported Standard	3G SDI
Input Resolution	720p@50/60   1080p@50/60
<b>Quad DVI output</b>	
Connector Appearance	
Numbers of Input	4
Connector Type	DVI-I
Output Resolution	800×600@60~3840×570@60
<b>Quad HDMI output with background/OSD</b>	
Connector Appearance	
Numbers of Input	4

Connector Type	HDMI-A
Supported Standard	HDMI1.3
Output Resolution	800×600@60~3840×570@60
Key Feature	Support background and scrolling OSD
<b>Dual HDMI2.0 4K60 output</b>	
Connector Appearance	
Numbers of Input	2
Connector Type	HDMI-A
Supported Standard	HDMI2.0
Output Resolution	1024×768@60~4096×2160@60
<b>Quad HDBaseT output</b>	
Connector Appearance	
Numbers of Input	4
Connector Type	RJ45
Output Resolution	800×600@60~3840×2160@30
<b>Quad SD/HD/3G SDI output</b>	
Connector Appearance	
Numbers of Input	4
Connector Type	BNC
Supported Standard	3G SDI
Input Resolution	720P@50/60   1080p@24/30/50/60
<b>Analog audio input/output</b>	
Connector Appearance	
Numbers of Input	8
Connector Type	3.5mm Audio Jack(4 In   4 Out)
<b>PVW</b>	
Connector Appearance	
Numbers of Input	2
Connector Type	1×HDMI-A   1×RJ45

---

## 6.2 Terms & Definitions

- **RCA:** Connector used primarily in consumer AV equipment for both audio and video. The RCA connector was developed by the Radio Corporation of America.
- **BNC:** Stands for Bayonet Neill-Concelman. A cable connector used extensively in television (named for its inventors). A cylindrical bayonet connector that operates with a twist-locking motion .
- **CVBS:** CVBS or Composite video, is an analog video signal without audio. Most commonly CVBS is used for transmission of standard definition signals. In consumer applications the connector is typically RCA type, while in professional applications the connector is BNC type.
- **YPbPr:** Used to describe the colour space for progressive-scan. Otherwise known as component video.
- **VGA:** Video Graphics Array. VGA is an analog signal typically used on earlier computers. The signal is non-interlaced in modes 1, 2, and 3 and interlaced when using in mode.
- **DVI:** Digital Visual Interface. The digital video connectivity standard that was developed by DDWG (Digital Display Work Group). This connection standard offers two different connectors: one with 24 pins that handles digital video signals only, and one with 29 pins that handles both digital and analog video.
- **SDI:** Serial Digital Interface. Standard definition video is carried on this 270 Mbps data transfer rate. Video pixels are characterized with a 10-bit depth and 4:2:2 color quantization. Ancillary data is included on this interface and typically includes audio or other metadata. Up to sixteen audio channels can be transmitted. Audio is organised into blocks of 4 stereo pairs. Connector is BNC.
- **HD-SDI:** High-definition serial digital interface (HD-SDI), is standardized in SMPTE 292M this provides a nominal data rate of 1.485 Gbit/s.
- **3G-SDI:** Standardized in SMPTE 424M, consists of a single 2.970 Gbit/s serial link that allows replacing dual link HD-SDI.
- **6G-SDI:** Standardized in SMPTE ST-2081 released in 2015, 6Gbit/s bitrate and able to support 2160p@30.
- **12G-SDI:** Standardized in SMPTE ST-2082 released in 2015, 12Gbit/s bitrate and able to support 2160p@60.
- **U-SDI:** Technology for transmitting large-volume 8K signals over a single cable. a signal interface called the ultra high definition signal/data interface (U-SDI) for transmitting 4K and 8K signals using a single optical cable. The interface was standardized as the SMPTE ST 2036-4.
- **HDMI:** High Definition Multimedia Interface: An interface used for the transmission of uncompressed high definition video, up to 8 channels of audio, and control signals, over a single cable.
- **HDMI 1.3:** Released on June 22 2006, and increased the maximum TMDS clock to 340 MHz (10.2 Gbit/s). Support resolution 1920 × 1080 at 120 Hz or 2560 × 1440 at 60 Hz). It added support for 10 bpc, 12 bpc, and 16 bpc color depth (30, 36, and 48 bit/px), called deep color.

- 
- **HDMI 1.4:** Released on June 5, 2009, added support for 4096 × 2160 at 24 Hz, 3840 × 2160 at 24, 25, and 30 Hz, and 1920 × 1080 at 120 Hz. Compared to HDMI 1.3, 3 more features added which are HDMI Ethernet Channel (HEC), audio return channel (ARC), 3D Over HDMI, a new Micro HDMI Connector, an expanded set of color spaces.
  - **HDMI 2.0:** Released on September 4, 2013 increases the maximum bandwidth to 18.0 Gbit/s. Other features of HDMI 2.0 include up to 32 audio channels, up to 1536 kHz audio sample frequency, the HE-AAC and DRA audio standards, improved 3D capability, and additional CEC functions.
  - **HDMI 2.0a:** Was released on April 8, 2015, and added support for High Dynamic Range (HDR) video with static metadata.
  - **HDMI 2.0b:** Was released March, 2016, support for HDR Video transport and extends the static metadata signaling to include Hybrid Log-Gamma (HLG).
  - **HDMI 2.1:** Released on November 28, 2017. It adds support for higher resolutions and higher refresh rates, Dynamic HDR including 4K 120 Hz and 8K 120 Hz.
  - **DisplayPort:** A VESA standard interface primarily for video, but also for audio, USB and other data. DisplayPort (or DP) is backwards compatible with HDMI, DVI and VGA.
  - **DP 1.1:** Was ratified on 2 April 2007, and version 1.1a was ratified on 11 January 2008. DisplayPort 1.1 allow a maximum bandwidth of 10.8 Gbit/s (8.64 Gbit/s data rate) over a standard 4-lane main link, enough to support 1920x1080@60Hz
  - **DP 1.2:** Introduced on 7 January 2010, effective bandwidth to 17.28 Gbit/s support increased resolutions, higher refresh rates, and greater color depth, maximum resolution 3840 × 2160@60Hz
  - **DP 1.4:** Publish on 1 Mar, 2016. overall transmission bandwidth 32.4 Gbit/s, DisplayPort 1.4 adds support for Display Stream Compression 1.2 (DSC), DSC is a "visually lossless" encoding technique with up to a 3:1 compression ratio. Using DSC with HBR3 transmission rates, DisplayPort 1.4 can support 8K UHD (7680 × 4320) at 60 Hz or 4K UHD (3840 × 2160) at 120 Hz with 30 bit/px RGB color and HDR. 4K at 60 Hz 30 bit/px RGB/HDR can be achieved without the need for DSC.
  - **Multi-mode Fiber:** Fibers that support many propagation paths or transverse modes are called multi-mode fibers, generally have a wider core diameter and are used for short-distance communication links and for applications where high power must be transmitted.
  - **Single-mode Fiber:** Fiber that support a single mode are called single-mode fibers. Single-mode fibers are used for most communication links longer than 1,000 meters (3,300 ft).
  - **SFP:** Small form-factor pluggable, is a compact, hot-pluggable network interface module used for both telecommunication and data communications applications.
  - **Optical Fiber Connector:** Terminates the end of an optical fiber, and enables quicker connection and disconnection than splicing. The connectors mechanically couple and align the cores of fibers so light can pass. 4 most common types of optical fiber connectors are SC, FC, LC, ST.

●**SC:** (Subscriber Connector), also known as the square connector was also created by the Japanese company – Nippon Telegraph and Telephone. SC is a push-pull coupling type of connector and has a 2.5mm diameter. Nowadays, it is used mostly in single mode fiber optic patch cords, analog, GBIC, and CATV. SC is one of the most popular options, as its simplicity in design comes along with great durability and affordable prices.

●**LC:** (Lucent Connector) is a small factor connector (uses only a 1.25mm ferrule diameter) that has a snap coupling mechanism. Because of its small dimensions, it is the perfect fit for high-density connections, XFP, SFP, and SFP+ transceivers.

●**FC:** (Ferrule Connector) is a screw type connector with a 2.5mm ferrule. FC is a round shaped threaded fiber optic connector, mostly used on Datacom, telecom, measurement equipment, single-mode laser.

●**ST:** (Straight Tip) was invented by AT&T and uses a bayonet mount along with a long spring-loaded ferrule to support the fiber.









●**USB:** Universal Serial Bus is a standard that was developed in the mid-1990s that defines cables, connectors and communication protocols. This technology is designed to allow a connection, communication and power supply for peripheral devices and computers.

●**USB 1.1:** Full-Bandwidth USB, specification was the first release to be widely adopted by the consumer market. This specification allowed for a maximum bandwidth of 12Mbps.

●**USB 2.0:** or Hi-Speed USB, specification made many improvements over USB 1.1. The main improvement was an increase in bandwidth to a maximum of 480Mbps.

● **USB 3.2:** Super Speed USB with 3 varieties of 3.2 Gen 1(original name USB 3.0), 3.2Gen 2(original name USB 3.1), 3.2 Gen 2x2 (original name USB 3.2) with speed up to 5Gbps,10Gbps,20Gbps respectively.

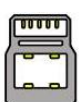
USB version and connectors figure:

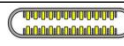
	Type A	Type B	Mini A	Mini B	Micro-A	Micro-B	Type C
USB 2.0							
USB 3.0							
USB 3.1&3.2							

●**NTSC:** The colour video standard used in North America and some other parts of the world created by the National Television Standards Committee in the 1950s. NTSC utilizes an interlaced video signals.

---

●**PAL:** Phase Alternate Line. A television standard in which the phase of the colour carrier is alternated from line to line. It takes four full images (8 fields) for the colour-to-horizontal images (8 fields) for the colour-to-horizontal phase relationship to return to the reference point. This alternation helps cancel out phase errors. For this reason, the hue control is not needed on a PAL TV set. PAL, is widely used in Western Europe, Australia, Africa, the Middle East, and Micronesia. PAL uses 625-line, 50-field (25 fps) composite colour transmission system.

●**SMPTE:** Society of Motion image and Television Engineers. A global organization, based in the United States, that sets standards for baseband visual communications. This includes film as well as video and television standards.

●**VESA:** Video Electronics Standards Association. An organization facilitating computer graphics through standards.

●**HDCP:** High-bandwidth Digital Content Protection (HDCP) was developed by Intel Corporation and is in wide use for protection of video during transmission between devices.

●**HDBaseT:** A video standard for the transmission of uncompressed video (HDMI signals) and related features using Cat 5e/Cat6 cabling infrastructure.

●**ST2110:** A SMPTE developed standard, ST2110 describes how to send digital video over and IP networks. Video is transmitted uncompressed with audio and other data in a separate streams. SMPTE2110 is intended principally for broadcast production and distribution facilities where quality and flexibility are more important.

●**SDVoE:** Software Defined Video over Ethernet (SDVoE) is a method for transmission, distribution and management AV signals using a TCP/IP Ethernet infrastructure for transport with low latency. SDVoE is commonly used in integration applications.

●**Dante AV:** The Dante protocol was developed for and widely adopted in audio systems for the transmission of uncompressed digital audio on IP based networks. The more recent Dante AV specification includes support for digital video.

●**NDI:** Network Device interface (NDI) is a software standard developed by NewTek to enable video-compatible products to communicate, deliver, and receive broadcast quality video in a high quality, low latency manner that is frame-accurate and suitable for switching in a live production environment over TCP (UDP) Ethernet based networks. NDI is commonly found in broadcast applications.

●**RTMP:** Real-Time Messaging Protocol (RTMP) was initially a proprietary protocol developed by Macromedia (now Adobe) for streaming audio, video and data over the Internet, between a Flash player and a server.

●**RTSP:** The Real Time Streaming Protocol (RTSP) is a network control protocol designed for use in entertainment and communications systems to control streaming media servers. The protocol is used for establishing and controlling media sessions between end points.

●**MPEG:** Moving Picture Experts Group is a working group formed from ISO and IEC developing standards that allow audio/video digital compression and Transmission.



---

●**H.264:** Also known as AVC (Advanced Video Coding) or MPEG-4i is a common video compression standard. H.264 was standardized by the ITU-T Video Coding Experts Group (VCEG) together with the ISO/IEC JTC1 Moving Picture Experts Group (MPEG).

●**H.265:** Also known as **HEVC** (High Efficiency Video Coding) H.265 is the successor to the widely used H.264/AVC digital video coding standard. Developed under the auspices of ITU, resolutions up to 8192x4320 may be compressed.

●**API:** An Application Programming Interface (API) provides a predefined function which allows access capabilities and features or routines via a software or hardware, without accessing source code or understanding the details of inner working mechanism. An API call may execute a function and/or provide data feedback/report.

●**DMX512:** The communication standard developed by USITT for entertainment and digital lighting systems. The wide adoption of the Digital Multiplex (DMX) protocol has seen the protocol used for a wide range of other devices including video controllers. DMX512 is delivered over cable of 2 twisted pairs with 5pin XLR cables for connection.

●**ArtNet:** An ethernet protocol based on TCP/IP protocol stack, mainly used in entertainment/events applications. Built on the DMX512 data format, ArtNet enables multiple “universes” of DMX512 to be transmitted using ethernet networks for transport.

●**MIDI:** MIDI is the abbreviation of Musical Instrument Digital Interface. As the name indicates the protocol was developed for communication between electronic musical instruments and latterly computers. MIDI instructions are triggers or commands sent over twisted pair cables, typically using 5pin DIN connectors.

●**OSC:** The principle of Open Sound Control (OSC) protocol is for networking sound synthesizers, computers, and multimedia devices for musical performance or show control. As with XML and JSON, the OSC protocol allows sharing data. OSC is transported via UDP packets between devices connected on an Ethernet.

●**Brightness:** Usually refers to the amount or intensity of video light produced on a screen without regard to colour. Sometimes called black level.

●**Contrast Ratio:** The ratio of the high light output level divided by the low light output level. In theory, the contrast ratio of the television system should be at least 100:1, if not 300:1. In reality, there are several limitations. Well-controlled viewing conditions should yield a practical contrast ratio of 30:1 to 50:1.

●**Colour Temperature:** The colour quality, expressed in degrees Kelvin (K), of a light source. The higher the colour temperature, the bluer the light. The lower the temperature, the redder the light. Benchmark colour temperature for the A/V industry include 5000°K, 6500°K, and 9000°K.

●**Saturation:** Chroma, Chroma gain. The intensity of the colour, or the extent to which a given colour in any image is free from white. The less white in a colour, the truer the colour or the greater its saturation. Saturation is the amount of pigment in a colour, and not the intensity.

---

●**Gamma:** The light output of a CRT is not linear with respect to the voltage input. The difference between what you should have and what is actually output is known as gamma.

●**Frame:** In interlaced video, a frame is one complete image. A video frame is made up of two fields, or two sets of interlaced lines. In a film, a frame is one still image of a series that makes up a motion image.

●**Genlock:** Allows synchronisation of otherwise video devices. A signal generator provides a signal pulses which connected devices can reference. Also see Black Burst and Color Burst.

●**Blackburst:** The video waveform without the video elements. It includes the vertical sync, horizontal sync, and the Chroma burst information. Blackburst is used to synchronize video equipment to align the video output.

●**Colour Burst:** In colour TV systems, a burst of subcarrier frequency located on the back part of the composite video signal. This serves as a colour synchronizing signal to establish a frequency and phase reference for the Chroma signal. Colour burst is 3.58 MHz for NTSC and 4.43 MHz for PAL.

●**Colour Bars:** A standard test pattern of several basic colours (white, yellow, cyan, green, magenta, red, blue, and black) as a reference for system alignment and testing. In NTSC video, the most commonly used colour bars are the SMPTE standard colour bars. In PAL video, the most commonly used colour bars are eight full field bars. On computer monitors the most commonly used colour bars are two rows of reversed colour bars

●**Seamless Switching:** A feature found on many video switchers. This feature causes the switcher to wait until the vertical interval to switch. This avoids a glitch (temporary scrambling) which often is seen when switching between sources.

●**Scaling:** A conversion of a video or computer graphic signal from a starting resolution to a new resolution. Scaling from one resolution to another is typically done to optimize the signal for input to an image processor, transmission path or to improve its quality when presented on a particular display.

●**PIP:** Picture-In-Picture. A small image within a larger image created by scaling down one of image to make it smaller. Other forms of PIP displays include Picture-By-Picture (PBP) and Picture- With-Picture (PWP), which are commonly used with 16:9 aspect display devices. PBP and PWP image formats require a separate scaler for each video window .

●**HDR:** is a high dynamic range (HDR) technique used in imaging and photography to reproduce a greater dynamic range of luminosity than what is possible with standard digital imaging or photographic techniques. The aim is to present a similar range of luminance to that experienced through the human visual system.

●**UHD:** Standing for Ultra High Definition and comprising 4K and 8K television standards with a 16:9 ratio, UHD follows the 2K HDTV standard. A UHD 4K display has a physical resolution of 3840x2160 which is four times the area and twice both the width and height of a HDTV/FullHD (1920x1080) video signal.

●**EDID:** Extended Display Identification Data. EDID is a data structure used to communicate video display information, including native resolution and vertical interval refresh rate requirements, to a source device. The source device will then output the provided EDID data, ensuring proper video image quality.

---

## 6.3 Revision History

The table below lists the changes to the User Manual.

Format	Time	ECO#	Description	Principal
V1.0	2021-08-19	0000#	Release	Sylvia
V1.1	2022-01-12	0001#	Update product picture	Sylvia
V1.2	2022-04-26	0002#	Add Q16pro-14 info	Aster

All information herein is Xiamen RGBlink Science & Technology Co Ltd. excepting noted. **RGBlink**<sup>®</sup> is a registered trademark of Xiamen RGBlink Science & Technology Co Ltd. While all efforts are made for accuracy at time of printing, we reserve the right to alter otherwise make change without notice.