

HAZE SIDEBOARD

ASSEMBLY MANUAL

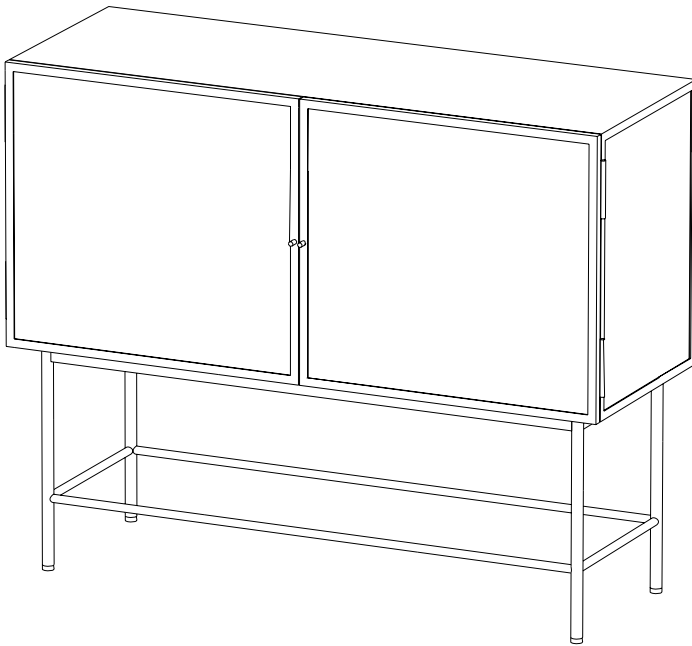

ferm
L I V I N G

BOX CONTENTS

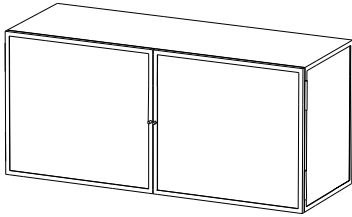

1 x cabinet

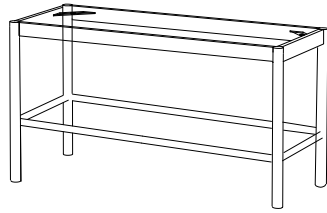

1 x legs



1 x shelf

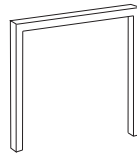

1 x u-formed stabiliser



4 x M8 16 mm screws



2 x M5 10 mm screws

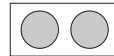

2 x rubber pads

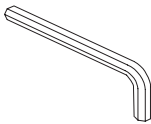

1 x hex key 5 mm

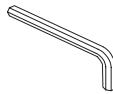

1 x hex key 3 mm

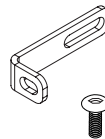

2 x wall-safety set
(M6 16 mm screws x 2)

NEEDED IN ORDER TO ASSEMBLE



Min. two people



Spirit level

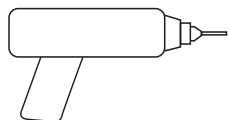

Power drill



Screwdriver



Pencil

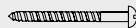

2 x screws

2 x rawlplugs

NB!

Screws and rawlplugs
are not included, as
different kinds of
walls require different
rawlplugs/screws.

Warning

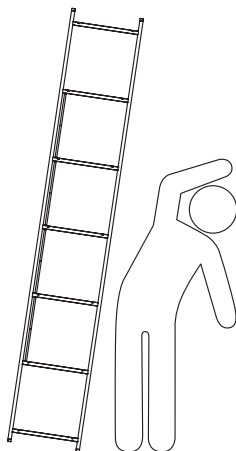

ASSEMBLY PROCESS

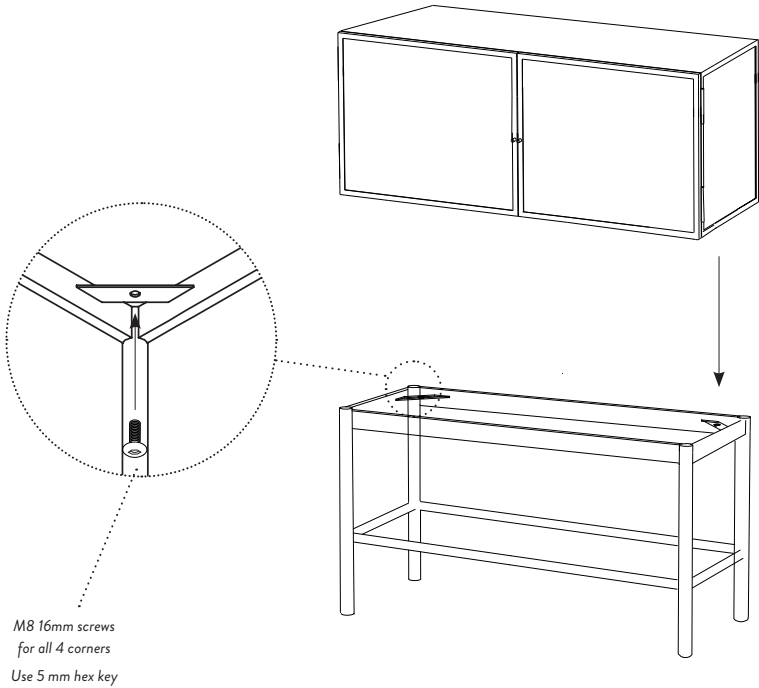

1

Please mount the cabinet to the legs
using the screws indicated above.

ASSEMBLY PROCESS

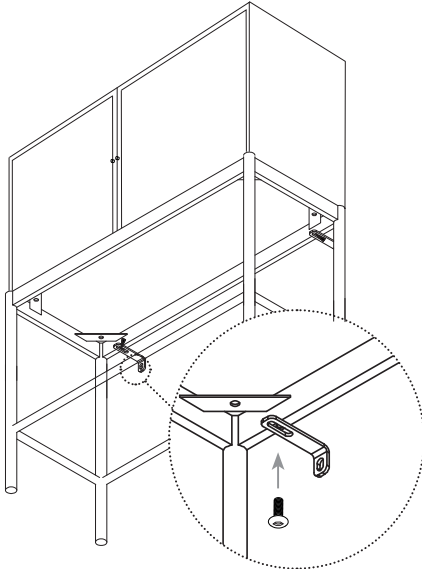

M6 16 mm screws x 2
Use 4 mm hex key

2

We recommend mounting the sideboard against a wall with the included wall safety set.

Mount the wall safety set onto the sideboard and place it against the wall. Screw the wall safety onto the cabinet. Do not tighten screws yet.

3

Remember to level the sideboard with the adjustable feet to avoid the sideboard becoming crooked.

If needed, pre-drill holes and insert rawlplugs.

Screw the wall safety into the wall. Finally, tighten the screws into the cabinet.

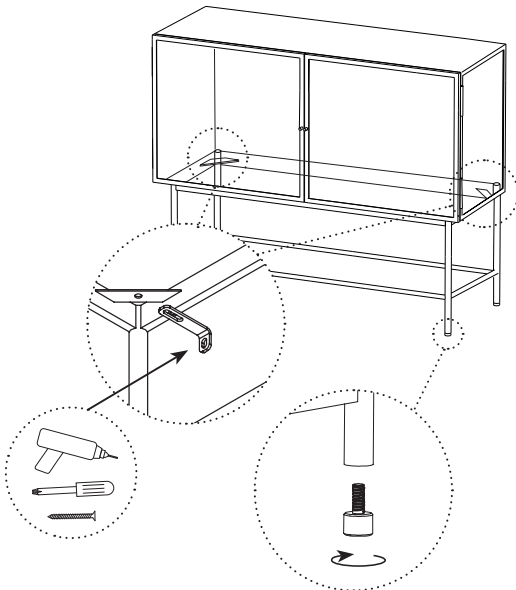

4.

ASSEMBLY PROCESS

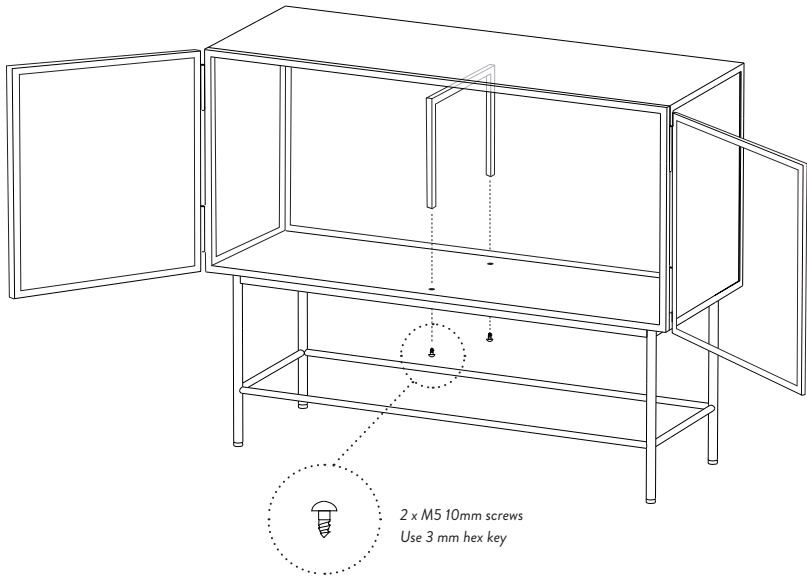

4

Insert the u-formed stabiliser inside the cabinet so that it faces downwards. Place it upon the pre-drilled holes at the bottom of the cabinet, then use the hex key to fasten the two screws from underneath.

5.

ASSEMBLY PROCESS

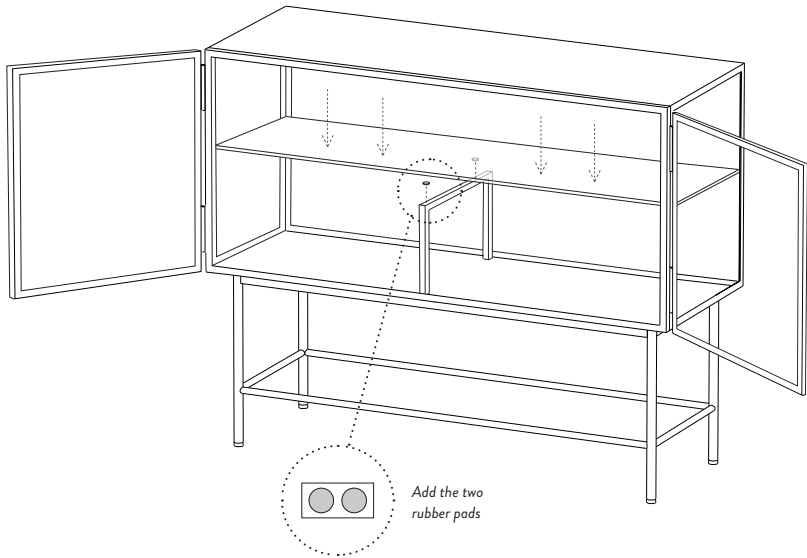

5

Add the two rubber pads on top of the u-form to prevent friction between the parts. Then place the metal shelf inside the cabinet and lower it down, so that it ends up resting upon the u-form as well as the support in the four corners.

6.

fermliving.com