

# FLYING SHELF - SPHERE

---

ASSEMBLY MANUAL

[fermliving.com](http://fermliving.com)

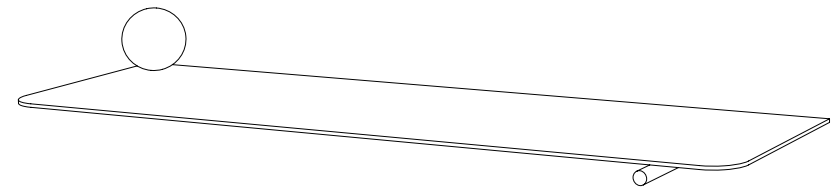

NOT SUITABLE  
FOR PLASTER  
WALLS!

**ferm**  
LIVING

## CONTENT OF THE BOX

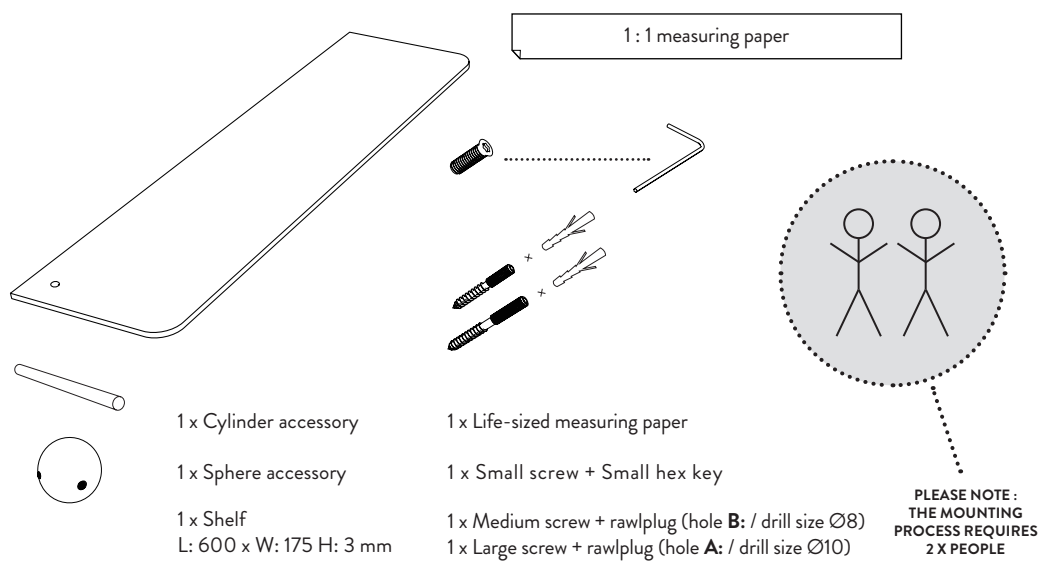

## ASSEMBLY PROCESS

NOT SUITABLE  
FOR PLASTER  
WALLS!

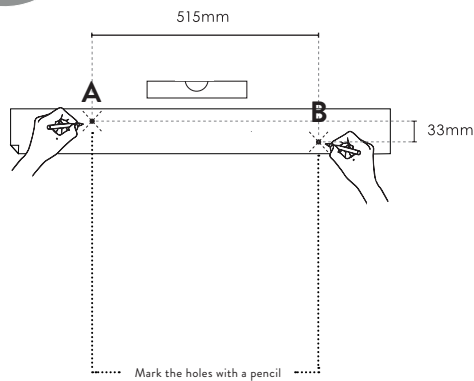

**WARNING:**  
Different wall materials require different types of rawlplugs or fixing devices. For advice on suitable fixing systems, contact your local specialized dealer. Rawlplugs enclosed are intended for brick wall.

1. Use a good position on the wall. Ensure that the markings are on the bricks of the wall and not the sealant. Use the enclosed life-sized measuring paper to mark the holes **A** and **B**:

Hold the paper against the wall and make sure that it is level. If needed; tape the measuring paper to the wall. Punch through the paper with a pencil to mark the placement of the two holes.

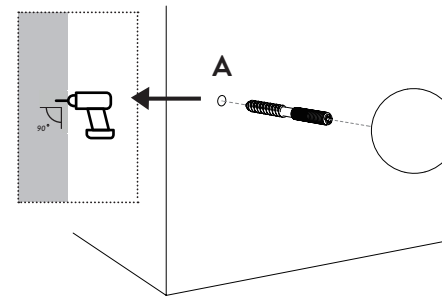

2. Start by drilling hole **A** (drill size Ø10). Make sure that you drill straight into the wall in a 90 degree angle. Insert rawlplug in the hole. Screw the large screw into the wall by using a screwdriver with a 6-star bit. Rotate the sphere accessory onto the screw.

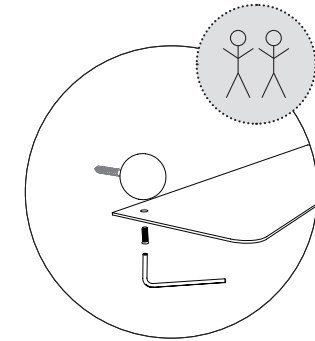

3. Mount the shelf to the sphere accessory by inserting the small screw beneath the sphere. The shelf should be placed in between the sphere and the screw. Use the small hex key to tighten the screw.

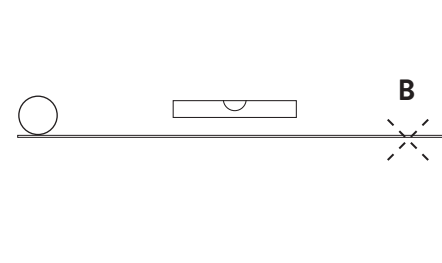

4. Now; make sure that the shelf is level. Raise the right side of the shelf up to the previously marked **B**. It is possible that you will have to correct the mark slightly. Use a spirit level for measurement.

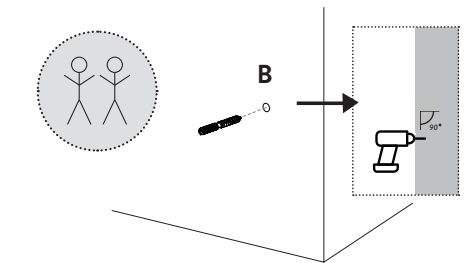

5. When the shelf is level, drill hole **B** (drill size Ø8) and insert rawlplug in the hole. Make sure that the shelf is raised above the hole before screwing the medium screw into the wall by using a screwdriver with a 6-star

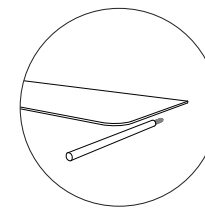

5. Rotate the cylinder accessory onto the screw.

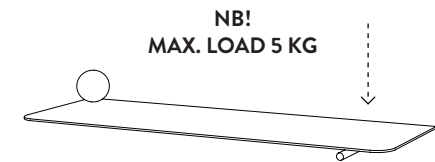

6. Lower the shelf down on the cylinder, so that it ends up resting on it. The Flying Shelf is now mounted correctly.